

**Lucent Technologies**  
Bell Labs Innovations



**DEFINITY<sup>®</sup>**  
**Enterprise Communications Server**  
Release 6  
Administration and Feature Description

555-230-522  
Comcode 108215740  
Issue 4  
May 1998

## Notice

Every effort was made to ensure that the information in this book was complete and accurate at the time of printing. However, information is subject to change.

## Your Responsibility for Your System's Security

Toll fraud is the unauthorized use of your telecommunications system by an unauthorized party, for example, persons other than your company's employees, agents, subcontractors, or persons working on your company's behalf. Note that there may be a risk of toll fraud associated with your telecommunications system and, if toll fraud occurs, it can result in substantial additional charges for your telecommunications services.

You and your system manager are responsible for the security of your system, such as programming and configuring your equipment to prevent unauthorized use. The system manager is also responsible for reading all installation, instruction, and system administration documents provided with this product in order to fully understand the features that can introduce risk of toll fraud and the steps that can be taken to reduce that risk. Lucent Technologies does not warrant that this product is immune from or will prevent unauthorized use of common-carrier telecommunication services or facilities accessed through or connected to it. Lucent Technologies will not be responsible for any charges that result from such unauthorized use.

## Lucent Technologies Fraud Intervention

If you *suspect that you are being victimized* by toll fraud and you need technical support or assistance, call Technical Service Center Toll Fraud Intervention Hotline at 1 800 643-2353.

## Federal Communications Commission Statement

**Part 15: Class A Statement.** This equipment has been tested and found to comply with the limits for a Class A digital device, pursuant to Part 15 of the FCC Rules. These limits are designed to provide reasonable protection against harmful interference when the equipment is operated in a commercial environment. This equipment generates, uses, and can radiate radio-frequency energy and, if not installed and used in accordance with the instructions, may cause harmful interference to radio communications. Operation of this equipment in a residential area is likely to cause harmful interference, in which case the user will be required to correct the interference at his own expense.

**Part 68: Network Registration Number.** This equipment is registered with the FCC in accordance with Part 68 of the FCC Rules. It is identified by FCC registration number AS593M-13283-MF-E.

**Part 68: Answer-Supervision Signaling.** Allowing this equipment to be operated in a manner that does not provide proper answer-supervision signaling is in violation of Part 68 Rules. This equipment returns answer-supervision signals to the public switched network when:

- Answered by the called station
- Answered by the attendant
- Routed to a recorded announcement that can be administered by the CPE user

This equipment returns answer-supervision signals on all DID calls forwarded back to the public switched telephone network. Permissible exceptions are:

- A call is unanswered
- A busy tone is received
- A reorder tone is received

## Canadian Department of Communications (DOC)

### Interference Information

This digital apparatus does not exceed the Class A limits for radio noise emissions set out in the radio interference regulations of the Canadian Department of Communications.

Le Présent Appareil Numérique n'émet pas de bruits radioélectriques dépassant les limites applicables aux appareils numériques de la class A prescrites dans le règlement sur le brouillage radioélectrique édicté par le ministère des Communications du Canada.

### Trademarks

See the preface of this document.

### Ordering Information

**Call:** Lucent Technologies BCS Publications Center  
Voice 1 800 457-1235 International Voice 317 322-6416  
Fax 1 800 457-1764 International Fax 317 322-6699

**Write:** Lucent Technologies BCS Publications Center  
2855 N. Franklin Road  
Indianapolis, IN 46219

**Order:** Document No. 555-230-522  
Comcode 108215740  
Issue 4, May 1998

For additional documents, refer to Appendix C, "References."

You can be placed on a standing order list for this and other documents you may need. Standing order will enable you to automatically receive updated versions of individual documents or document sets, billed to account information that you provide. For more information on standing orders, or to be put on a list to receive future issues of this document, contact the Lucent Technologies Publications Center.

### European Union Declaration of Conformity

The "CE" mark affixed to the DEFINITY® equipment described in this book indicates that the equipment conforms to the following European Union (EU) Directives:

- Electromagnetic Compatibility (89/336/EEC)
- Low Voltage (73/23/EEC)
- Telecommunications Terminal Equipment (TTE) i-CTR3 BRI and i-CTR4 PRI

For more information on standards compliance, contact your local distributor.

### Comments

To comment on this document, return the comment card at the front of the document.

### Acknowledgment

This document was prepared by Product Documentation Development, Lucent Technologies, Denver, CO.

# Contents

|  |                            |
|--|----------------------------|
| <a href="#">Contents</a>   | <a href="#">iii</a>        |
| <a href="#">List of Features</a>                                     | <a href="#">xix</a>        |
| <a href="#">List of Forms</a>  | <a href="#">xxvii</a>      |
| <a href="#">About This Document</a>                                  | <a href="#">xxxi</a>       |
| ■ <a href="#">Overview</a>   | <a href="#">xxxi</a>       |
| ■ <a href="#">Purpose</a>  | <a href="#">xxxi</a>       |
| ■ <a href="#">Audience</a>   | <a href="#">xxxii</a>      |
| ■ <a href="#">Reason for reissue</a>                                 | <a href="#">xxxii</a>      |
| ■ <a href="#">How to use this document</a>                           | <a href="#">xxxii</a>      |
| ■ <a href="#">Organization</a>                                       | <a href="#">xxxii</a>      |
| ■ <a href="#">Feature-related information</a>                        | <a href="#">xxxiv</a>      |
| ■ <a href="#">Conventions used in this document</a>                  | <a href="#">xxxiv</a>      |
| ■ <a href="#">Trademarks and service marks</a>                       | <a href="#">xxxv</a>       |
| ■ <a href="#">How to get help</a>                                    | <a href="#">xxxvi</a>      |
| ■ <a href="#">How to make comments about this document</a>           | <a href="#">xxxvii</a>     |
| <b><a href="#">1 Before You Begin</a></b>                            | <b><a href="#">1-1</a></b> |
| ■ <a href="#">Overview</a>   | <a href="#">1-1</a>        |
| ■ <a href="#">Communications survey</a>                              | <a href="#">1-1</a>        |
| ■ <a href="#">Administration sequence</a>                            | <a href="#">1-5</a>        |
| <b><a href="#">2 System Basics</a></b>                               | <b><a href="#">2-1</a></b> |
| ■ <a href="#">Overview</a>   | <a href="#">2-1</a>        |
| ■ <a href="#">How to log in and log off</a>                          | <a href="#">2-2</a>        |
| ■ <a href="#">Using the SAT</a>                                      | <a href="#">2-4</a>        |
| ■ <a href="#">Commands</a>   | <a href="#">2-6</a>        |
| ■ <a href="#">Login administration</a>                               | <a href="#">2-7</a>        |
| ■ <a href="#">Remote administration</a>                              | <a href="#">2-14</a>       |
| ■ <a href="#">How to set the system date and time</a>                | <a href="#">2-17</a>       |
| ■ <a href="#">How to print on demand</a>                             | <a href="#">2-18</a>       |
| ■ <a href="#">System backup for R6vs/si and later configurations</a> | <a href="#">2-18</a>       |
| ■ <a href="#">System backup for R6r and later configurations</a>     | <a href="#">2-24</a>       |

|                 |  |                   |
|-----------------|--|-------------------|
| <b><u>3</u></b> | <b><u>System Security</u></b>                                    | <b><u>3-1</u></b> |
| ■               | <u>Overview</u>  | <u>3-1</u>        |
| ■               | <u>Learn about the problem</u>                                   | <u>3-1</u>        |
| ■               | <u>Where to get help</u>   | <u>3-1</u>        |
| ■               | <u>Basic security</u>  | <u>3-2</u>        |
| ■               | <u>Physical security</u>   | <u>3-3</u>        |
| ■               | <u>Features requiring security precautions</u>                   | <u>3-3</u>        |
| <b><u>4</u></b> | <b><u>Basic Features</u></b>                                     | <b><u>4-1</u></b> |
| ■               | <u>Abbreviated Dialing</u>                                       | <u>4-1</u>        |
| ■               | <u>Administered Connections</u>                                  | <u>4-13</u>       |
| ■               | <u>Administrable Language Displays</u>                           | <u>4-20</u>       |
| ■               | <u>Administration without Hardware</u>                           | <u>4-40</u>       |
| ■               | <u>Alphanumeric Dialing</u>                                      | <u>4-49</u>       |
| ■               | <u>Alternate Operations Support System Alarm Number</u>          | <u>4-51</u>       |
| ■               | <u>Answer Detection</u>  | <u>4-52</u>       |
| ■               | <u>Attendant Auto-Manual Splitting</u>                           | <u>4-54</u>       |
| ■               | <u>Attendant Backup Alerting</u>                                 | <u>4-55</u>       |
| ■               | <u>Attendant Call Waiting</u>                                    | <u>4-57</u>       |
| ■               | <u>Attendant Calling of Inward Restricted Stations</u>           | <u>4-60</u>       |
| ■               | <u>Attendant Console</u>   | <u>4-61</u>       |
| ■               | <u>Attendant Control of Trunk Group Access</u>                   | <u>4-62</u>       |
| ■               | <u>Attendant Crisis Alert</u>                                    | <u>4-66</u>       |
| ■               | <u>Attendant Direct Extension Selection with Busy Lamp Field</u> | <u>4-68</u>       |
| ■               | <u>Attendant Direct Trunk Group Selection</u>                    | <u>4-72</u>       |
| ■               | <u>Attendant Display</u>   | <u>4-74</u>       |
| ■               | <u>Attendant Intrusion</u>                                       | <u>4-83</u>       |
| ■               | <u>Attendant Override of Diversion Features</u>                  | <u>4-84</u>       |
| ■               | <u>Attendant Priority Queue</u>                                  | <u>4-85</u>       |
| ■               | <u>Attendant Recall</u>  | <u>4-88</u>       |
| ■               | <u>Attendant Release Loop Operation</u>                          | <u>4-89</u>       |
| ■               | <u>Attendant Serial Calling</u>                                  | <u>4-90</u>       |

|  |                       |
|--|-----------------------|
| ■ <a href="#">Audible Message Waiting</a>                        | <a href="#">4-92</a>  |
| ■ <a href="#">Authorization Codes</a>                            | <a href="#">4-93</a>  |
| ■ <a href="#">Auto Start and Don't Split</a>                     | <a href="#">4-97</a>  |
| ■ <a href="#">Automated Attendant</a>                            | <a href="#">4-98</a>  |
| ■ <a href="#">Automatic Callback</a>                             | <a href="#">4-100</a> |
| ■ <a href="#">Automatic Circuit Assurance</a>                    | <a href="#">4-104</a> |
| ■ <a href="#">Automatic Incoming Call Display</a>                | <a href="#">4-108</a> |
| ■ <a href="#">Block Collect Call</a>                             | <a href="#">4-110</a> |
| ■ <a href="#">Bridged Call Appearance</a>                        | <a href="#">4-112</a> |
| ■ <a href="#">Bulletin Board</a>                                 | <a href="#">4-128</a> |
| ■ <a href="#">Busy Verification of Terminals and Trunks</a>      | <a href="#">4-130</a> |
| ■ <a href="#">Button View</a>                                    | <a href="#">4-135</a> |
| ■ <a href="#">Call Charge Information</a>                        | <a href="#">4-136</a> |
| ■ <a href="#">Call Coverage</a>                                  | <a href="#">4-146</a> |
| ■ <a href="#">Call Detail Recording</a>                          | <a href="#">4-167</a> |
| ■ <a href="#">Call Forwarding</a>                                | <a href="#">4-224</a> |
| ■ <a href="#">Call Park</a>                                      | <a href="#">4-232</a> |
| ■ <a href="#">Call Pickup</a>                                    | <a href="#">4-236</a> |
| ■ <a href="#">Call Timer</a>                                     | <a href="#">4-242</a> |
| ■ <a href="#">Call Waiting Termination</a>                       | <a href="#">4-244</a> |
| ■ <a href="#">Calling Party/Billing Number</a>                   | <a href="#">4-246</a> |
| ■ <a href="#">Calling Party Number Restriction</a>               | <a href="#">4-247</a> |
| ■ <a href="#">CallVisor Adjunct-Switch Application Interface</a> | <a href="#">4-250</a> |
| ■ <a href="#">Class of Restriction</a>                           | <a href="#">4-264</a> |
| ■ <a href="#">Class of Service</a>                               | <a href="#">4-277</a> |
| ■ <a href="#">Code Calling Access</a>                            | <a href="#">4-280</a> |
| ■ <a href="#">Conference — Attendant</a>                         | <a href="#">4-282</a> |
| ■ <a href="#">Conference — Terminal</a>                          | <a href="#">4-284</a> |
| ■ <a href="#">Consult</a>  | <a href="#">4-286</a> |
| ■ <a href="#">Coverage Callback</a>                              | <a href="#">4-287</a> |
| ■ <a href="#">Coverage Incoming Call Identification</a>          | <a href="#">4-288</a> |
| ■ <a href="#">Customer-Provided-Equipment Alarm</a>              | <a href="#">4-289</a> |
| ■ <a href="#">Data Call Setup</a>                                | <a href="#">4-290</a> |
| ■ <a href="#">Data Hotline</a>                                   | <a href="#">4-298</a> |

|  |                       |
|--|-----------------------|
| ■ <a href="#">Data Privacy</a>   | <a href="#">4-301</a> |
| ■ <a href="#">Data Restriction</a>   | <a href="#">4-303</a> |
| ■ <a href="#">Data-Only Off-Premises Extensions</a>                                    | <a href="#">4-305</a> |
| ■ <a href="#">Default Dialing</a>  | <a href="#">4-307</a> |
| ■ <a href="#">Demand Print</a>   | <a href="#">4-309</a> |
| ■ <a href="#">Dial Access to Attendant</a>   | <a href="#">4-310</a> |
| ■ <a href="#">Dial Plan</a>  | <a href="#">4-311</a> |
| ■ <a href="#">Distinctive Ringing</a>  | <a href="#">4-314</a> |
| ■ <a href="#">Dual DCP I-Channels</a>  | <a href="#">4-317</a> |
| ■ <a href="#">Emergency Access to the Attendant</a>                                    | <a href="#">4-318</a> |
| ■ <a href="#">Enhanced Voice Terminal Display</a>                                      | <a href="#">4-322</a> |
| ■ <a href="#">Extended User Administration of Redirected Calls</a>                     | <a href="#">4-333</a> |
| ■ <a href="#">External Device Alarming</a>   | <a href="#">4-340</a> |
| ■ <a href="#">Facility Busy Indication</a>   | <a href="#">4-341</a> |
| ■ <a href="#">Facility Test Calls</a>  | <a href="#">4-343</a> |
| ■ <a href="#">Flexible Billing</a>   | <a href="#">4-345</a> |
| ■ <a href="#">Go to Cover</a>  | <a href="#">4-348</a> |
| ■ <a href="#">Group Listen</a>   | <a href="#">4-349</a> |
| ■ <a href="#">Group Paging</a>   | <a href="#">4-352</a> |
| ■ <a href="#">Hold</a>   | <a href="#">4-358</a> |
| ■ <a href="#">Hold — Automatic</a>   | <a href="#">4-361</a> |
| ■ <a href="#">Hot Line Service</a>   | <a href="#">4-363</a> |
| ■ <a href="#">Hunt Groups</a>  | <a href="#">4-365</a> |
| ■ <a href="#">Incoming Call Line Identification on Analog Trunks</a>                   | <a href="#">4-373</a> |
| ■ <a href="#">Individual Attendant Access</a>  | <a href="#">4-376</a> |
| ■ <a href="#">Integrated Directory</a>   | <a href="#">4-379</a> |
| ■ <a href="#">Integrated Services Digital Network — Basic Rate Interface Endpoints</a> | <a href="#">4-382</a> |
| ■ <a href="#">Intercept Treatment</a>  | <a href="#">4-390</a> |
| ■ <a href="#">Intercom — Automatic</a>   | <a href="#">4-393</a> |
| ■ <a href="#">Intercom — Dial</a>  | <a href="#">4-395</a> |
| ■ <a href="#">Internal Automatic Answer</a>  | <a href="#">4-397</a> |
| ■ <a href="#">International Operator Access</a>  | <a href="#">4-401</a> |
| ■ <a href="#">Last Number Dialed</a>   | <a href="#">4-403</a> |
| ■ <a href="#">Leave Word Calling</a>   | <a href="#">4-405</a> |

|   |                       |
|---|-----------------------|
| ■ <a href="#">Line Lockout</a>                                | <a href="#">4-409</a> |
| ■ <a href="#">Listed Directory Numbers</a>                    | <a href="#">4-410</a> |
| ■ <a href="#">Loudspeaker Paging Access</a>                   | <a href="#">4-412</a> |
| ■ <a href="#">Malicious Call Trace</a>                        | <a href="#">4-422</a> |
| ■ <a href="#">Manual Message Waiting</a>                      | <a href="#">4-429</a> |
| ■ <a href="#">Manual Originating Line Service</a>             | <a href="#">4-430</a> |
| ■ <a href="#">Manual Signaling</a>                            | <a href="#">4-432</a> |
| ■ <a href="#">Messaging Server Interface</a>                  | <a href="#">4-433</a> |
| ■ <a href="#">Multifrequency Signaling</a>                    | <a href="#">4-438</a> |
| ■ <a href="#">Misoperation Handling</a>                       | <a href="#">4-445</a> |
| ■ <a href="#">Modem Pooling</a>                               | <a href="#">4-449</a> |
| ■ <a href="#">Multiappearance Preselection and Preference</a> | <a href="#">4-452</a> |
| ■ <a href="#">Music-on-Hold Access</a>                        | <a href="#">4-455</a> |
| ■ <a href="#">Night Service</a>                               | <a href="#">4-457</a> |
| ■ <a href="#">Off-Premises Station</a>                        | <a href="#">4-467</a> |
| ■ <a href="#">On-Hook Dialing</a>                             | <a href="#">4-469</a> |
| ■ <a href="#">PC Console</a>                                  | <a href="#">4-470</a> |
| ■ <a href="#">PC/PBX Connection</a>                           | <a href="#">4-471</a> |
| ■ <a href="#">Personal Station Access</a>                     | <a href="#">4-474</a> |
| ■ <a href="#">Personalized Ringing</a>                        | <a href="#">4-480</a> |
| ■ <a href="#">Power Failure Transfer</a>                      | <a href="#">4-482</a> |
| ■ <a href="#">Priority Calling</a>                            | <a href="#">4-483</a> |
| ■ <a href="#">Privacy — Attendant Lockout</a>                 | <a href="#">4-486</a> |
| ■ <a href="#">Privacy — Manual Exclusion</a>                  | <a href="#">4-487</a> |
| ■ <a href="#">Public Network Call Priority</a>                | <a href="#">4-489</a> |
| ■ <a href="#">Pull Transfer</a>                               | <a href="#">4-496</a> |
| ■ <a href="#">Recall Signaling</a>                            | <a href="#">4-498</a> |
| ■ <a href="#">Recorded Announcement</a>                       | <a href="#">4-500</a> |
| ■ <a href="#">Recorded Telephone Dictation Access</a>         | <a href="#">4-508</a> |
| ■ <a href="#">Remote Access</a>                               | <a href="#">4-509</a> |
| ■ <a href="#">Restricted/Unrestricted Call Lists</a>          | <a href="#">4-515</a> |
| ■ <a href="#">Restriction — Controlled</a>                    | <a href="#">4-518</a> |
| ■ <a href="#">Ringback Queuing</a>                            | <a href="#">4-520</a> |
| ■ <a href="#">Ringer Cutoff</a>                               | <a href="#">4-523</a> |
| ■ <a href="#">Ringing — Abbreviated and Delayed</a>           | <a href="#">4-526</a> |

|  |                       |
|--|-----------------------|
| ■ <a href="#">Security Violation Notification</a>                  | <a href="#">4-531</a> |
| ■ <a href="#">Send All Calls</a>                                   | <a href="#">4-538</a> |
| ■ <a href="#">Service Observing</a>                                | <a href="#">4-539</a> |
| ■ <a href="#">Single-Digit Dialing and Mixed Station Numbering</a> | <a href="#">4-553</a> |
| ■ <a href="#">Station Hunting</a>                                  | <a href="#">4-557</a> |
| ■ <a href="#">Station Security Codes</a>                           | <a href="#">4-563</a> |
| ■ <a href="#">Temporary Bridged Appearance</a>                     | <a href="#">4-566</a> |
| ■ <a href="#">Tenant Partitioning</a>                              | <a href="#">4-568</a> |
| ■ <a href="#">Terminal Self Administration</a>                     | <a href="#">4-578</a> |
| ■ <a href="#">Terminal Translation Initialization</a>              | <a href="#">4-583</a> |
| ■ <a href="#">Terminating Extension Group</a>                      | <a href="#">4-591</a> |
| ■ <a href="#">Timed Reminder and Attendant Timers</a>              | <a href="#">4-594</a> |
| ■ <a href="#">Transfer</a>   | <a href="#">4-597</a> |
| ■ <a href="#">Transfer — Outgoing Trunk to Outgoing Trunk</a>      | <a href="#">4-599</a> |
| ■ <a href="#">Trunk Flash</a>                                      | <a href="#">4-603</a> |
| ■ <a href="#">Trunk Group Busy/Warning Indicators to Attendant</a> | <a href="#">4-607</a> |
| ■ <a href="#">Trunk Identification by Attendant</a>                | <a href="#">4-609</a> |
| ■ <a href="#">Trunk-to-Trunk Transfer</a>                          | <a href="#">4-611</a> |
| ■ <a href="#">Visually Impaired Attendant Service</a>              | <a href="#">4-613</a> |
| ■ <a href="#">Voice Message Retrieval</a>                          | <a href="#">4-615</a> |
| ■ <a href="#">Voice Messaging Systems</a>                          | <a href="#">4-618</a> |
| ■ <a href="#">Voice Terminal Alerting Options</a>                  | <a href="#">4-625</a> |
| ■ <a href="#">Voice Terminal Display</a>                           | <a href="#">4-626</a> |
| ■ <a href="#">Whisper Page</a>                                     | <a href="#">4-633</a> |
| ■ <a href="#">World-Class Tone Detection</a>                       | <a href="#">4-642</a> |
| ■ <a href="#">World-Class Tone Generation</a>                      | <a href="#">4-643</a> |

**5** **Basic Forms** **5-1**

|  |                      |
|--|----------------------|
| ■ <a href="#">Abbreviated Dialing List — Enhanced List</a>     | <a href="#">5-2</a>  |
| ■ <a href="#">Abbreviated Dialing List — Group List</a>        | <a href="#">5-5</a>  |
| ■ <a href="#">Abbreviated Dialing List — Personal List</a>     | <a href="#">5-8</a>  |
| ■ <a href="#">Abbreviated Dialing List — System List</a>       | <a href="#">5-11</a> |
| ■ <a href="#">Abbreviated Dialing List — 7103A Button List</a> | <a href="#">5-14</a> |



|   |                       |
|---|-----------------------|
| ■ <a href="#">Administered Connection</a>                               | <a href="#">5-17</a>  |
| ■ <a href="#">Alias Station</a>   | <a href="#">5-21</a>  |
| ■ <a href="#">Alphanumeric Dialing Table</a>                            | <a href="#">5-23</a>  |
| ■ <a href="#">Announcements/Audio Sources</a>                           | <a href="#">5-26</a>  |
| ■ <a href="#">Attendant Console</a>                                     | <a href="#">5-35</a>  |
| ■ <a href="#">Authorization Code — COR Mapping</a>                      | <a href="#">5-54</a>  |
| ■ <a href="#">Bulletin Board</a>  | <a href="#">5-56</a>  |
| ■ <a href="#">Cabinet</a>   | <a href="#">5-58</a>  |
| ■ <a href="#">CAMA Numbering Format form</a>                            | <a href="#">5-61</a>  |
| ■ <a href="#">CDR System Parameters</a>                                 | <a href="#">5-63</a>  |
| ■ <a href="#">Circuit Packs</a>   | <a href="#">5-69</a>  |
| ■ <a href="#">Class of Restriction</a>                                  | <a href="#">5-72</a>  |
| ■ <a href="#">Class of Service</a>                                      | <a href="#">5-81</a>  |
| ■ <a href="#">Code Calling IDs</a>                                      | <a href="#">5-84</a>  |
| ■ <a href="#">Console-Parameters</a>                                    | <a href="#">5-86</a>  |
| ■ <a href="#">Coverage Answer Group</a>                                 | <a href="#">5-92</a>  |
| ■ <a href="#">Coverage Path</a>   | <a href="#">5-94</a>  |
| ■ <a href="#">Dial Plan Record</a>                                      | <a href="#">5-99</a>  |
| ■ <a href="#">Duplication-Related System Parameters</a>                 | <a href="#">5-104</a> |
| ■ <a href="#">ETA Call Screening Table</a>                              | <a href="#">5-106</a> |
| ■ <a href="#">Extensions Administered to have an MCT-Control Button</a> | <a href="#">5-108</a> |
| ■ <a href="#">External Device Alarm</a>                                 | <a href="#">5-109</a> |
| ■ <a href="#">Feature Access Code</a>                                   | <a href="#">5-113</a> |
| ■ <a href="#">Feature-Related System Parameters</a>                     | <a href="#">5-123</a> |
| ■ <a href="#">Fiber Link Administration</a>                             | <a href="#">5-146</a> |
| ■ <a href="#">Hunt Group</a>  | <a href="#">5-158</a> |
| ■ <a href="#">Intercom Group</a>  | <a href="#">5-175</a> |
| ■ <a href="#">Inter-Exchange Carrier (IXC) Codes</a>                    | <a href="#">5-177</a> |
| ■ <a href="#">Interface Links</a>                                       | <a href="#">5-179</a> |
| ■ <a href="#">Intra-Switch CDR</a>                                      | <a href="#">5-183</a> |
| ■ <a href="#">ISDN-BRI Trunk Circuit Pack</a>                           | <a href="#">5-186</a> |
| ■ <a href="#">Language Translations</a>                                 | <a href="#">5-193</a> |
| ■ <a href="#">Listed Directory Numbers</a>                              | <a href="#">5-207</a> |
| ■ <a href="#">Loudspeaker Paging</a>                                    | <a href="#">5-209</a> |

|   |                       |
|---|-----------------------|
| ■ <a href="#">Maintenance-Related System Parameters</a>   | <a href="#">5-212</a> |
| ■ <a href="#">Mode Code Related System Parameters</a>   | <a href="#">5-220</a> |
| ■ <a href="#">Modem Pool Group</a>  | <a href="#">5-223</a> |
| ■ <a href="#">Multifrequency-Signaling-Related System Parameters</a>  | <a href="#">5-228</a> |
| ■ <a href="#">Music Sources</a>   | <a href="#">5-243</a> |
| ■ <a href="#">Packet Gateway Board</a>  | <a href="#">5-246</a> |
| ■ <a href="#">Processor Channel Assignment for R5r and later Installations</a>                              | <a href="#">5-248</a> |
| ■ <a href="#">Processor Channel Assignment for R5si and later Installations</a>                             | <a href="#">5-252</a> |
| ■ <a href="#">Pickup Group</a>  | <a href="#">5-256</a> |
| ■ <a href="#">Remote Access</a>   | <a href="#">5-258</a> |
| ■ <a href="#">Remote Call Coverage Table</a>  | <a href="#">5-263</a> |
| ■ <a href="#">Second Digit Table</a>  | <a href="#">5-264</a> |
| ■ <a href="#">Security-Related System Parameters</a>  | <a href="#">5-266</a> |
| ■ <a href="#">System Parameters Country-Options</a>   | <a href="#">5-271</a> |
| ■ <a href="#">System Parameters Customer-Options</a>  | <a href="#">5-277</a> |
| ■ <a href="#">System Parameters OCM Call Classification</a>   | <a href="#">5-289</a> |
| ■ <a href="#">Telecommuting Access</a>  | <a href="#">5-291</a> |
| ■ <a href="#">Tenant</a>  | <a href="#">5-292</a> |
| ■ <a href="#">Terminating Extension Group</a>   | <a href="#">5-295</a> |
| ■ <a href="#">Time of Day Coverage Table</a>  | <a href="#">5-298</a> |
| ■ <a href="#">Toll Analysis</a>   | <a href="#">5-299</a> |
| ■ <a href="#">User Defined Adjunct Names</a>  | <a href="#">5-303</a> |
| <b>6</b> <a href="#">Voice Terminal, PC Interface, and Data Module Administration</a>                       | <a href="#">6-1</a>   |
| ■ <a href="#">Voice terminals — general</a>   | <a href="#">6-4</a>   |
| ■ <a href="#">Terminal Parameters form</a>  | <a href="#">6-9</a>   |
| ■ <a href="#">Voice-terminal feature button descriptions</a>  | <a href="#">6-14</a>  |
| ■ <a href="#">Station form field descriptions</a>   | <a href="#">6-28</a>  |
| ■ <a href="#">10-MET, 20-MET, and 30-MET voice terminals</a>  | <a href="#">6-41</a>  |
| ■ <a href="#">500, 2500, K2500, 7101A, 7102A, 7103A, 7104A, 8110, DS1FD, DS1SA, and VRU voice terminals</a> | <a href="#">6-47</a>  |

|   |                              |
|---|------------------------------|
| ■ <a href="#">510D personal terminal and 515 business communications terminal</a>         | <a href="#">6-55</a>         |
| ■ <a href="#">6402, 6402D, 6408, 6408+, 6408D, 6408D+, 6416D+, 6424D+ voice terminals</a> | <a href="#">6-60</a>         |
| ■ <a href="#">7302H, 7303H, and 7305H MERLIN voice terminals</a>                          | <a href="#">6-72</a>         |
| ■ <a href="#">7303S, 7305S, and 7309H voice terminals</a>                                 | <a href="#">6-73</a>         |
| ■ <a href="#">7313H, 7314H, 7315H, 7316H, and 7317H voice terminals</a>                   | <a href="#">6-80</a>         |
| ■ <a href="#">7401D, 7401+, 7403D, 7404D, 7410D, and 7410+ voice terminals</a>            | <a href="#">6-90</a>         |
| ■ <a href="#">7405D voice terminal</a>  | <a href="#">6-99</a>         |
| ■ <a href="#">7406D, 7406+, 7407D, and 7407+ voice terminals</a>                          | <a href="#">6-111</a>        |
| ■ <a href="#">7434D and 7444D voice terminal</a>  | <a href="#">6-121</a>        |
| ■ <a href="#">7505D, 7506D, 7507D, 8503D, 8510T, and 8520T ISDN-BRI voice terminals</a>   | <a href="#">6-130</a>        |
| ■ <a href="#">CALLMASTER II and III voice terminals</a>                                   | <a href="#">6-141</a>        |
| ■ <a href="#">CALLMASTER VI voice terminal</a>  | <a href="#">6-147</a>        |
| ■ <a href="#">Personal Computer</a>   | <a href="#">6-153</a>        |
| ■ <a href="#">Constellation voice/data terminals</a>                                      | <a href="#">6-158</a>        |
| ■ <a href="#">MDC9000 and MDW9000 cordless voice terminals</a>                            | <a href="#">6-163</a>        |
| ■ <a href="#">CP9530 cordless voice terminals</a>   | <a href="#">6-168</a>        |
| ■ <a href="#">8403B, 8405B, 8405B+ and 8410B voice terminals</a>                          | <a href="#">6-172</a>        |
| ■ <a href="#">8405D, 8405D+, 8410D, and 8434D voice terminals</a>                         | <a href="#">6-180</a>        |
| ■ <a href="#">8411B and 8411D voice terminals</a>   | <a href="#">6-189</a>        |
| ■ <a href="#">World Class Basic Rate Interface terminal</a>                               | <a href="#">6-194</a>        |
| <b><a href="#">PC Interface Administration</a></b>  | <b><a href="#">6-217</a></b> |
| ■ <a href="#">EIA Interface</a>   | <a href="#">6-218</a>        |
| ■ <a href="#">PC Interface</a>  | <a href="#">6-220</a>        |
| <b><a href="#">Data Module Administration</a></b>   | <b><a href="#">6-225</a></b> |
| ■ <a href="#">Data Modules — general</a>  | <a href="#">6-226</a>        |
| ■ <a href="#">Data module form field description</a>                                      | <a href="#">6-230</a>        |
| ■ <a href="#">Announcement Data Module</a>  | <a href="#">6-233</a>        |
| ■ <a href="#">Data Line Data Module</a>   | <a href="#">6-234</a>        |
| ■ <a href="#">Processor/Trunk Data Module</a>   | <a href="#">6-243</a>        |
| ■ <a href="#">Netcon Data Module</a>  | <a href="#">6-245</a>        |

|  |                            |
|--|----------------------------|
| ■ <a href="#">Processor Interface Data Module</a>                | <a href="#">6-246</a>      |
| ■ <a href="#">System Port Data Module</a>                        | <a href="#">6-248</a>      |
| ■ <a href="#">X.25 Data Module</a>                               | <a href="#">6-249</a>      |
| ■ <a href="#">7500 Data Module</a>                               | <a href="#">6-252</a>      |
| ■ <a href="#">World Class BRI Data Module</a>                    | <a href="#">6-255</a>      |
| <b><a href="#">7 Trunk Group Administration</a></b>              | <b><a href="#">7-1</a></b> |
| ■ <a href="#">Automatic Transmission Measurement System</a>      | <a href="#">7-2</a>        |
| ■ <a href="#">DS1 Trunk Service</a>                              | <a href="#">7-11</a>       |
| ■ <a href="#">Digital Multiplexed Interface</a>                  | <a href="#">7-19</a>       |
| ■ <a href="#">Enhanced ICSU</a>                                  | <a href="#">7-21</a>       |
| ■ <a href="#">ISDN Trunks— General</a>                           | <a href="#">7-25</a>       |
| ■ <a href="#">Call-by-Call Service Selection</a>                 | <a href="#">7-42</a>       |
| ■ <a href="#">Facility and Non-Facility Associated Signaling</a> | <a href="#">7-49</a>       |
| ■ <a href="#">Wideband Switching</a>                             | <a href="#">7-56</a>       |
| ■ <a href="#">Trunk Group Administration Forms</a>               | <a href="#">7-71</a>       |
| ■ <a href="#">Access Endpoint</a>                                | <a href="#">7-72</a>       |
| ■ <a href="#">ATMS Trunk Test Schedule</a>                       | <a href="#">7-76</a>       |
| ■ <a href="#">DS1 Circuit Pack form</a>                          | <a href="#">7-79</a>       |
| ■ <a href="#">Digit Absorption</a>                               | <a href="#">7-91</a>       |
| ■ <a href="#">ISDN Numbering — Private</a>                       | <a href="#">7-93</a>       |
| ■ <a href="#">ISDN Numbering — Public/ Unknown</a>               | <a href="#">7-95</a>       |
| ■ <a href="#">ISDN TSC Gateway Channel Assignments</a>           | <a href="#">7-98</a>       |
| ■ <a href="#">Network-Facilities</a>                             | <a href="#">7-100</a>      |
| ■ <a href="#">PRI Endpoint</a>                                   | <a href="#">7-102</a>      |
| ■ <a href="#">Signaling Group</a>                                | <a href="#">7-106</a>      |
| ■ <a href="#">Synchronization Plan</a>                           | <a href="#">7-112</a>      |
| ■ <a href="#">Trunk Groups — General</a>                         | <a href="#">7-115</a>      |
| ■ <a href="#">Access trunk group</a>                             | <a href="#">7-150</a>      |
| ■ <a href="#">APLT trunk group</a>                               | <a href="#">7-156</a>      |
| ■ <a href="#">CAMA - E911 trunk group</a>                        | <a href="#">7-161</a>      |
| ■ <a href="#">CO trunk group</a>                                 | <a href="#">7-168</a>      |
| ■ <a href="#">CPE trunk group</a>                                | <a href="#">7-174</a>      |
| ■ <a href="#">DID trunk group</a>                                | <a href="#">7-178</a>      |
| ■ <a href="#">DIOD trunk group</a>                               | <a href="#">7-183</a>      |
| ■ <a href="#">DMI-BOS trunk group</a>                            | <a href="#">7-188</a>      |

|   |                             |
|---|-----------------------------|
| ■ <a href="#">FX trunk group</a>  | <a href="#">7-193</a>       |
| ■ <a href="#">ISDN-BRI trunk group</a>                                  | <a href="#">7-198</a>       |
| ■ <a href="#">ISDN-PRI trunk group</a>                                  | <a href="#">7-219</a>       |
| ■ <a href="#">PCOL trunk group</a>                                      | <a href="#">7-246</a>       |
| ■ <a href="#">RLT trunk group</a>                                       | <a href="#">7-252</a>       |
| ■ <a href="#">Tandem trunk group</a>                                    | <a href="#">7-257</a>       |
| ■ <a href="#">Tie trunk group</a>                                       | <a href="#">7-262</a>       |
| ■ <a href="#">WATS trunk group</a>                                      | <a href="#">7-268</a>       |
| <b><a href="#">8 Automatic Routing</a></b>                              | <b><a href="#">8-1</a></b>  |
| ■ <a href="#">Automatic Routing — General</a>                           | <a href="#">8-2</a>         |
| ■ <a href="#">AAR and ARS</a>   | <a href="#">8-3</a>         |
| ■ <a href="#">AAR and ARS Overlap Sending</a>                           | <a href="#">8-20</a>        |
| ■ <a href="#">AAR and ARS Partitioning</a>                              | <a href="#">8-21</a>        |
| ■ <a href="#">Facility Restriction Levels and Traveling Class Marks</a> | <a href="#">8-24</a>        |
| ■ <a href="#">Alternate Facility Restriction Levels</a>                 | <a href="#">8-29</a>        |
| ■ <a href="#">Generalized Route Selection</a>                           | <a href="#">8-33</a>        |
| ■ <a href="#">Look-Ahead Routing</a>                                    | <a href="#">8-45</a>        |
| ■ <a href="#">Subnet Trunking</a>                                       | <a href="#">8-48</a>        |
| ■ <a href="#">Time of Day Routing</a>                                   | <a href="#">8-50</a>        |
| <b><a href="#">Automatic Routing Forms</a></b>                          | <b><a href="#">8-54</a></b> |
| ■ <a href="#">AAR and ARS Digit Analysis Table</a>                      | <a href="#">8-55</a>        |
| ■ <a href="#">AAR and ARS Digit Conversion Table</a>                    | <a href="#">8-63</a>        |
| ■ <a href="#">Route Pattern form</a>                                    | <a href="#">8-67</a>        |
| ■ <a href="#">ARS Toll Table</a>  | <a href="#">8-75</a>        |
| ■ <a href="#">RHNPA Table</a>   | <a href="#">8-76</a>        |
| ■ <a href="#">Time of Day Routing Plan</a>                              | <a href="#">8-78</a>        |
| <b><a href="#">9 Call Center</a></b>                                    | <b><a href="#">9-1</a></b>  |
| ■ <a href="#">Abandoned Call Search</a>                                 | <a href="#">9-3</a>         |
| ■ <a href="#">Add/Remove Skills</a>                                     | <a href="#">9-5</a>         |
| ■ <a href="#">Agent Call Handling</a>                                   | <a href="#">9-7</a>         |
| ■ <a href="#">Auto-Available Split</a>                                  | <a href="#">9-22</a>        |
| ■ <a href="#">Automatic Call Distribution</a>                           | <a href="#">9-25</a>        |
| ■ <a href="#">Basic Call Management System</a>                          | <a href="#">9-40</a>        |
| ■ <a href="#">Best Service Routing™</a>                                 | <a href="#">9-44</a>        |

|  |                       |
|--|-----------------------|
| ■ <a href="#">Call Management System</a>     | <a href="#">9-58</a>  |
| ■ <a href="#">Call Prompting</a>             | <a href="#">9-60</a>  |
| ■ <a href="#">Call Vectoring</a>             | <a href="#">9-63</a>  |
| ■ <a href="#">Expert Agent Selection</a>     | <a href="#">9-72</a>  |
| ■ <a href="#">Inbound Call Management</a>    | <a href="#">9-81</a>  |
| ■ <a href="#">Information Forwarding</a>     | <a href="#">9-89</a>  |
| ■ <a href="#">Intraflow and Interflow</a>    | <a href="#">9-95</a>  |
| ■ <a href="#">Look-Ahead Interflow</a>       | <a href="#">9-98</a>  |
| ■ <a href="#">Multiple Call Handling</a>     | <a href="#">9-104</a> |
| ■ <a href="#">Queue Status Indications</a>   | <a href="#">9-110</a> |
| ■ <a href="#">Reason Codes</a>               | <a href="#">9-112</a> |
| ■ <a href="#">Redirection on No Answer</a>   | <a href="#">9-116</a> |
| ■ <a href="#">Universal Call ID</a>          | <a href="#">9-130</a> |
| ■ <a href="#">VDN in a Coverage Path</a>     | <a href="#">9-145</a> |
| ■ <a href="#">VDN of Origin Announcement</a> | <a href="#">9-146</a> |
| ■ <a href="#">Voice Response Integration</a> | <a href="#">9-152</a> |
| ■ <a href="#">VuStats</a>                    | <a href="#">9-161</a> |

**[Call Center Forms](#)** [9-192](#)

|   |                       |
|---|-----------------------|
| ■ <a href="#">Agent LoginID</a>                               | <a href="#">9-193</a> |
| ■ <a href="#">Best Service Routing (BSR) Application Plan</a> | <a href="#">9-197</a> |
| ■ <a href="#">BCMS/VuStats Login ID</a>                       | <a href="#">9-200</a> |
| ■ <a href="#">Call Center System Parameters</a>               | <a href="#">9-202</a> |
| ■ <a href="#">Call Vector</a>                                 | <a href="#">9-207</a> |
| ■ <a href="#">Reason Code Names</a>                           | <a href="#">9-211</a> |
| ■ <a href="#">SIT Treatment for Call Classification</a>       | <a href="#">9-212</a> |
| ■ <a href="#">Vector Directory Number</a>                     | <a href="#">9-214</a> |
| ■ <a href="#">Vector Routing Table</a>                        | <a href="#">9-219</a> |
| ■ <a href="#">VuStats Display Format</a>                      | <a href="#">9-221</a> |

**10 [Hospitality](#)** [10-1](#)

|  |                       |
|--|-----------------------|
| ■ <a href="#">Attendant Room Status</a>                | <a href="#">10-2</a>  |
| ■ <a href="#">Automatic Wakeup</a>                     | <a href="#">10-4</a>  |
| ■ <a href="#">Do Not Disturb</a>                       | <a href="#">10-11</a> |
| ■ <a href="#">Hospitality Services</a>                 | <a href="#">10-15</a> |
| ■ <a href="#">Names Registration</a>                   | <a href="#">10-17</a> |
| ■ <a href="#">Property Management System Interface</a> | <a href="#">10-21</a> |

|  |                     |
|--|---------------------|
| <b><u>Hospitality Forms</u></b>                        | <b><u>10-29</u></b> |
| ■ <u>Hospitality</u>                                   | <u>10-30</u>        |
| <b><u>11 Multimedia</u></b>                            | <b><u>11-1</u></b>  |
| ■ <u>Multimedia Applications Server Interface</u>      | <u>11-2</u>         |
| ■ <u>Multimedia Call Handling</u>                      | <u>11-30</u>        |
| ■ <u>Multimedia Forms</u>                              | <u>11-39</u>        |
| ■ <u>Basic Mode MM complex</u>                         | <u>11-59</u>        |
| ■ <u>Enhanced Mode MM complex</u>                      | <u>11-73</u>        |
| ■ <u>References</u>                                    | <u>11-98</u>        |
| <b><u>12 Private Networking</u></b>                    | <b><u>12-1</u></b>  |
| ■ <u>ATM-PNC</u>                                       | <u>12-3</u>         |
| ■ <u>Centralized Attendant Service</u>                 | <u>12-4</u>         |
| ■ <u>Distributed Communications System</u>             | <u>12-11</u>        |
| ■ <u>DCS Alphanumeric Display for Terminals</u>        | <u>12-27</u>        |
| ■ <u>DCS Attendant Control of Trunk Group Access</u>   | <u>12-28</u>        |
| ■ <u>DCS Attendant Direct Trunk Group Selection</u>    | <u>12-29</u>        |
| ■ <u>DCS Attendant Display</u>                         | <u>12-31</u>        |
| ■ <u>DCS Automatic Callback</u>                        | <u>12-32</u>        |
| ■ <u>DCS Automatic Circuit Assurance</u>               | <u>12-34</u>        |
| ■ <u>DCS Busy Verification of Terminals and Trunks</u> | <u>12-35</u>        |
| ■ <u>DCS Call Coverage</u>                             | <u>12-36</u>        |
| ■ <u>DCS Call Forwarding</u>                           | <u>12-41</u>        |
| ■ <u>DCS Call Waiting</u>                              | <u>12-42</u>        |
| ■ <u>DCS Distinctive Ringing</u>                       | <u>12-43</u>        |
| ■ <u>DCS Leave Word Calling</u>                        | <u>12-44</u>        |
| ■ <u>DCS Multiappearance Conference/Transfer</u>       | <u>12-46</u>        |
| ■ <u>DCS Over ISDN-PRI D-channel</u>                   | <u>12-47</u>        |
| ■ <u>DCS with Rerouting</u>                            | <u>12-50</u>        |
| ■ <u>DCS Trunk Group Busy/Warning Indication</u>       | <u>12-52</u>        |
| ■ <u>Emergency (911) Calls</u>                         | <u>12-54</u>        |
| ■ <u>Enhanced DCS</u>                                  | <u>12-55</u>        |

|  |                               |
|--|-------------------------------|
| ■ <a href="#">DCS feature considerations</a>                       | <a href="#">12-56</a>         |
| ■ <a href="#">Extended Trunk Access</a>                            | <a href="#">12-67</a>         |
| ■ <a href="#">Extension Number Portability</a>                     | <a href="#">12-70</a>         |
| ■ <a href="#">Inter-PBX Attendant Service</a>                      | <a href="#">12-72</a>         |
| ■ <a href="#">Node Number Routing</a>                              | <a href="#">12-74</a>         |
| ■ <a href="#">Private Network Access</a>                           | <a href="#">12-75</a>         |
| ■ <a href="#">QSIG</a>   | <a href="#">12-77</a>         |
| ■ <a href="#">QSIG Call Forwarding (Diversion)</a>                 | <a href="#">12-82</a>         |
| ■ <a href="#">QSIG Call Transfer</a>                               | <a href="#">12-84</a>         |
| ■ <a href="#">QSIG Name and Number Identification</a>              | <a href="#">12-86</a>         |
| ■ <a href="#">QSIG Path Replacement (ANF-PR)</a>                   | <a href="#">12-90</a>         |
| ■ <a href="#">QSIG Supplementary Service - Call Completion</a>     | <a href="#">12-91</a>         |
| ■ <a href="#">QSIG Supplementary Service - Call Offer</a>          | <a href="#">12-96</a>         |
| ■ <a href="#">QSIG Transit Counter (ANF-TC)</a>                    | <a href="#">12-99</a>         |
| ■ <a href="#">Uniform Dial Plan</a>                                | <a href="#">12-103</a>        |
| <b><a href="#">Private Networking Forms</a></b>                    | <b><a href="#">12-109</a></b> |
| ■ <a href="#">.ATM-PNC Form</a>                                    | <a href="#">12-110</a>        |
| ■ <a href="#">Extended Trunk Access Call Screening Form</a>        | <a href="#">12-113</a>        |
| ■ <a href="#">Extension Number Portability Numbering Plan Form</a> | <a href="#">12-115</a>        |
| ■ <a href="#">Hop Channel Assignments Form</a>                     | <a href="#">12-116</a>        |
| ■ <a href="#">Node Number Routing Form</a>                         | <a href="#">12-119</a>        |
| ■ <a href="#">Uniform Dial Plan Form</a>                           | <a href="#">12-121</a>        |
| <b><a href="#">A Transition Reference</a></b>                      | <b><a href="#">A-1</a></b>    |
| ■ <a href="#">DEFINITY ECS R6.1 to R6.3 Transition Reference</a>   | <a href="#">A-1</a>           |
| ■ <a href="#">Release 6.3 Features</a>                             | <a href="#">A-1</a>           |
| ■ <a href="#">Release 6.3 Enhancements</a>                         | <a href="#">A-12</a>          |
| <b><a href="#">B Administration Commands</a></b>                   | <b><a href="#">B-1</a></b>    |
| ■ <a href="#">Commands</a>   | <a href="#">B-1</a>           |
| ■ <a href="#">Add</a>  | <a href="#">B-2</a>           |
| ■ <a href="#">Change</a>   | <a href="#">B-3</a>           |
| ■ <a href="#">Clear</a>  | <a href="#">B-4</a>           |
| ■ <a href="#">Display</a>  | <a href="#">B-5</a>           |
| ■ <a href="#">Duplicate</a>  | <a href="#">B-6</a>           |
| ■ <a href="#">List</a>   | <a href="#">B-7</a>           |



|   |                             |
|---|-----------------------------|
| ■ <a href="#">Remove</a>  | <a href="#">B-8</a>         |
| ■ <a href="#">Status</a>  | <a href="#">B-9</a>         |
| <b><a href="#">C</a></b> <b><a href="#">References</a></b>                  | <b><a href="#">C-1</a></b>  |
| ■ <a href="#">Basic DEFINITY ECS Documents</a>                              | <a href="#">C-1</a>         |
| ■ <a href="#">Call Center Documents</a>                                     | <a href="#">C-5</a>         |
| ■ <a href="#">Application-Specific Documents</a>                            | <a href="#">C-6</a>         |
| ■ <a href="#">Documents on CD-ROM</a>                                       | <a href="#">C-10</a>        |
| <b><a href="#">GL</a></b> <b><a href="#">Glossary and Abbreviations</a></b> | <b><a href="#">GL-1</a></b> |
| <b><a href="#">IN</a></b> <b><a href="#">Index</a></b>                      | <b><a href="#">IN-1</a></b> |



# List of Features

## A

---

- AAR [8-3](#)
- AAR and ARS Overlap Sending [8-20](#)
- AAR and ARS Partitioning [8-21](#)
- Abandoned Call Search [9-3](#)
- Abbreviated Dialing [4-1](#)
- Add/Remove Skills [9-5](#)
- Administered Connections [4-13](#)
- Administrable Language Displays [4-20](#)
- Administration without Hardware [4-40](#)
- Agent Call Handling [9-7](#)
- Alphanumeric Dialing [4-49](#)
- Alternate Facility Restriction Levels [8-29](#)
- Alternate Operations Support System Alarm Number [4-51](#)
- Answer Detection [4-52](#)
- ARS [8-3](#)
- Attendant Auto-Manual Splitting [4-54](#)
- Attendant Backup Alerting [4-55](#)
- Attendant Call Waiting [4-57](#)
- Attendant Calling of Inward Restricted Stations [4-60](#)
- Attendant Console [4-61](#)
- Attendant Control of Trunk Group Access [4-62](#)
- Attendant Crisis Alert [4-66](#)
- Attendant Direct Extension Selection with Busy Lamp Field [4-68](#)
- Attendant Direct Trunk Group Selection [4-72](#)
- Attendant Display [4-74](#)
- Attendant Intrusion [4-83](#)
- Attendant Override of Diversion Features [4-84](#)
- Attendant Priority Queue [4-85](#)
- Attendant Recall [4-88](#)
- Attendant Release Loop Operation [4-89](#)
- Attendant Room Status [10-2](#)
- Attendant Serial Calling [4-90](#)
- Audible Message Waiting [4-92](#)
- Audio Information Exchange (AUDIX) Interface [4-618](#)
- Authorization Codes [4-93](#)
- Auto Start and Don't Split [4-97](#)
- Auto-Available Split [9-22](#)
- Automated Attendant [4-98](#)
- Automatic Call Distribution [9-25](#)

- Automatic Callback [4-100](#)
- Automatic Circuit Assurance [4-104](#)
- Automatic Incoming Call Display [4-108](#)
- Automatic Routing — General [8-2](#)
- Automatic Transmission Measurement System [7-2](#)
- Automatic Wakeup [10-4](#)

## B

---

- Basic Call Management System [9-40](#)
- Block Collect Call [4-110](#)
- Bridged Call Appearance [4-112](#)
- Bulletin Board [4-128](#)
- Busy Verification of Terminals and Trunks [4-130](#)
- Button View [4-135](#)

## C

---

- Call Charge Information [4-136](#)
- Call Coverage [4-146](#)
- Call Detail Recording [4-167](#)
- Call Forwarding [4-224](#)
- Call Management System [9-58](#)
- Call Park [4-232](#)
- Call Pickup [4-236](#)
- Call Prompting [9-60](#)
- Call Vectoring [9-63](#)
- Call Waiting Termination [4-244](#)
- Call-by-Call Service Selection [7-42](#)
- Calling Party/Billing Number [4-246](#)
- CallVisor Adjunct Switch Application Interface [4-250](#)
- Centralized Attendant Service [12-4](#)
- Class of Restriction [4-264](#)
- Class of Service [4-277](#)
- Code Calling Access [4-280](#)
- Conference — Attendant [4-282](#)
- Conference — Terminal [4-284](#)
- Consult [4-286](#)
- Coverage Callback [4-287](#)
- Coverage Incoming Call Identification [4-288](#)
- Customer-Provided-Equipment Alarm [4-289](#)

## D

---

- Data Call Setup [4-290](#)
- Data Hotline [4-298](#)
- Data Only Off Premises Extensions [4-305](#)
- Data Privacy [4-301](#)
- Data Restriction [4-303](#)
- DCS [12-11](#)
- DCS Alphanumeric Display for Terminals [12-27](#)
- DCS Attendant Control of Trunk Group Access [12-28](#)
- DCS Attendant Direct Trunk Group Selection [12-29](#)
- DCS Attendant Display [12-31](#)
- DCS Automatic Callback [12-32](#)
- DCS Automatic Circuit Assurance [12-34](#)
- DCS Busy Verification of Terminals and Trunks [12-35](#)
- DCS Call Coverage [12-36](#)
- DCS Call Forwarding [12-41](#)
- DCS Call Waiting [12-42](#)
- DCS Distinctive Ringing [12-43](#)
- DCS Leave Word Calling [12-44](#)
- DCS Multiappearance Conference/Transfer [12-46](#)
- DCS Over ISDN-PRI D-channel [12-47](#)
- DCS Trunk Group Busy/Warning Indication [12-52](#)
- Default Dialing [4-307](#)
- Demand Print [4-309](#)
- Dial Access to Attendant [4-310](#)
- Dial Plan [4-311](#)
- Digital Multiplexed Interface [7-19](#)
- Distinctive Ringing [4-314](#)
- Distributed Communications System [12-11](#)
- Do Not Disturb [10-11](#)
- DS1 Trunk Service [7-11](#)
- Dual DCP I-Channels [4-317](#)

## E

---

- EIA Interface [6-218](#)
- Emergency Access to the Attendant [4-318](#)
- Enhanced DCS [12-55](#)
- Enhanced ICSU [7-21](#)
- Enhanced Voice Terminal Display [4-322](#)
- Expert Agent Selection [9-72](#)
- Extended Trunk Access [12-67](#)

- Extended User Administration of Redirected Calls [4-333](#)
- Extension Number Portability [12-70](#)
- External Device Alarming [4-340](#)

## F

---

- Facility and Non-Facility Associated Signaling [7-49](#)
- Facility Busy Indication [4-341](#)
- Facility Restriction Levels and Traveling Class Marks [8-24](#)
- Facility Test Calls [4-343](#)
- Flexible Billing [4-345](#)

## G

---

- Generalized Route Selection [8-33](#)
- Go to Cover [4-348](#)
- Group Listen [4-349](#)
- Group Paging [4-352](#)

## H

---

- Hold [4-358](#)
- Hold — Automatic [4-361](#)
- Hospitality Services [10-15](#)
- Hot Line Service [4-363](#)
- Hunt Groups [4-365](#)

## I

---

- Inbound Call Management [9-81](#)
- Individual Attendant Access [4-376](#)
- Integrated Directory [4-379](#)
- Integrated Services Digital Network — Basic Rate Interface [4-382](#)
- Intercept Treatment [4-390](#)
- Intercom — Automatic [4-393](#)
- Intercom — Dial [4-395](#)
- Internal Automatic Answer [4-397](#)
- Inter-PBX Attendant Service (IAS) [12-72](#)
- Intraflow and Interflow [9-95](#)
- ISDN — General [7-25](#)

## L

---

- Last Number Dialed [4-403](#)
- Leave Word Calling [4-405](#)

- Line Lockout [4-409](#)
- Listed Directory Numbers [4-410](#)
- Look-Ahead Interflow [9-98](#)
- Look-Ahead Routing [8-45](#)
- Loudspeaker Paging Access [4-412](#)

## M

---

- Manual Message Waiting [4-429](#)
- Manual Originating Line Service [4-430](#)
- Manual Signaling [4-432](#)
- Messaging Server Interface [4-433](#)
- MF signaling [4-438](#)
- Misoperation Handling [4-445](#)
- Modem Pooling [4-449](#)
- Multiappearance Preselection and Preference [4-452](#)
- Multimedia Call Handling [11-30](#)
- Multiple Call Handling [9-104](#)
- Music-on-Hold Access [4-455](#)

## N

---

- Night Service [4-457](#)
- Node Number Routing [12-74](#)

## O

---

- Off-Premises Station [4-467](#)

## P

---

- PC Console [4-470](#)
- PC Interface [6-220](#)
- PC/PBX Connection [4-471](#)
- Personal Station Access [4-474](#)
- Personalized Ringing [4-480](#)
- Power Failure Transfer [4-482](#)
- Priority Calling [4-483](#)
- Privacy — Attendant Lockout [4-486](#)
- Privacy — Manual Exclusion [4-487](#)
- Private Network Access [12-75](#)
- Property Management System Interface [10-21](#)
- Public Network Call Priority [4-489](#)
- Pull Transfer [4-496](#)

## Q

---

- QSIG [12-77](#)
- QSIG Name and Number Identification [12-86](#)
- QSIG Transit Counter (ANF-TC) [12-99](#)
- Queue Status Indications [9-110](#)

## R

---

- Reason Codes [9-112](#)
- Recall Signaling [4-498](#)
- Recorded Announcement [4-500](#)
- Recorded Telephone Dictation Access [4-508](#)
- Redirection on No Answer [9-116](#)
- Remote Access [4-509](#)
- Restricted/Unrestricted Call Lists [4-515](#)
- Restriction — Controlled [4-518](#)
- Ringback Queuing [4-520](#)
- Ringer Cutoff [4-523](#)
- Ringing — Abbreviated and Delayed [4-526](#)

## S

---

- Security Violation Notification [4-531](#)
- Send All Calls [4-538](#)
- Service Observing [4-539](#)
- Single-Digit Dialing and Mixed Station Numbering [4-553](#)
- Station Hunting [4-557](#)
- Station Security Codes [4-563](#)
- Subnet Trunking [8-48](#)

## T

---

- Temporary Bridged Appearance [4-566](#)
- Tenant Partitioning [4-568](#)
- Terminal Self Administration [4-578](#)
- Terminal Translation Initialization [4-583](#)
- Terminating Extension Group [4-591](#)
- Time of Day Routing [8-50](#)
- Timed Reminder and Attendant Timers [4-594](#)
- Transfer [4-597](#)
- Transfer — Outgoing Trunk to Outgoing Trunk [4-599](#)
- Trunk Flash [4-603](#)
- Trunk Group Administration [7-1](#)



- Trunk Group Busy/Warning Indicators to Attendant [4-607](#)
- Trunk Identification by Attendant [4-609](#)
- Trunk-to-Trunk Transfer [4-611](#)

## U

---

- Uniform Dial Plan [12-103](#)

## V

---

- VDN in a Coverage Path [9-145](#)
- VDN of Origin Announcement [9-146](#)
- Visually Impaired Attendant Service [4-613](#)
- Voice Message Retrieval [4-615](#)
- Voice Response Integration [9-152](#)
- Voice Terminal Alerting Options [4-625](#)
- Voice Terminal Display [4-626](#)
- VuStats [9-161](#)

## W

---

- Wideband Switching [7-56](#)
- World-Class Tone Detection [4-642](#)
- World-Class Tone Generation [4-643](#)



# List of Forms

## Numerics

---

- 7500 Data Module [6-252](#)

## A

---

- AAR and ARS Digit Analysis Table [8-55](#)
- AAR and ARS Digit Conversion Table [8-63](#)
- Abbreviated Dialing List — 7103A Button List [5-14](#)
- Abbreviated Dialing List — Enhanced List [5-2](#)
- Abbreviated Dialing List — Group List [5-5](#)
- Abbreviated Dialing List — Personal List [5-8](#)
- Abbreviated Dialing List — System List [5-11](#)
- Access Endpoint [7-72](#)
- Access trunk group [7-150](#)
- Administered Connection [5-17](#)
- Agent LoginID [9-193](#)
- Alias Station [5-21](#)
- Alphanumeric Dialing Table [5-23](#)
- Announcement Data Module [6-233](#)
- Announcements/Audio Sources [5-26](#)
- APLT trunk group [7-156](#)
- ARS Toll Table [8-75](#)
- ATMS Trunk Test Schedule [7-76](#)
- Attendant Console [5-35](#)
- Authorization Code — COR Mapping [5-54](#)

## B

---

- BCMS/VuStats Login ID [9-200](#)
- Bulletin Board [5-56](#)

## C

---

- Cabinet [5-58](#)
- Call Center System Parameters [9-202](#)
- Call Vector [9-207](#)
- CDR System Parameters [5-63](#)
- Circuit Packs [5-69](#)
- Class of Restriction [5-72](#)
- Class of Service [5-81](#)
- CO trunk group [7-168](#)

- Code Calling IDs [5-84](#)
- Console-Parameters [5-86](#)
- Coverage Answer Group [5-92](#)
- Coverage Path [5-94](#)
- CPE trunk group [7-174](#)

## D

---

- Data Line Data Module [6-234](#)
- Dial Plan Record [5-99](#)
- DID trunk group [7-178](#)
- Digit Absorption [7-91](#)
- DIOD trunk group [7-183](#)
- DMI-BOS trunk group [7-188](#)
- DS1 Circuit Pack form [7-79](#)
- Duplication-Related System Parameters [5-104](#)

## E

---

- ETA Call Screening Table [5-106](#)
- Extended Trunk Access Call Screening [12-113](#)
- Extension Number Portability Numbering Plan [12-115](#)
- Extensions Administered to have an MCT-Control Button [5-108](#)
- External Device Alarm [5-109](#)

## F

---

- Feature Access Code (FAC) [5-113](#)
- Feature-Related System Parameters [5-123](#)
- Fiber Link Administration [5-146](#)
- FX trunk group [7-193](#)

## H

---

- Hop Channel Assignments [12-116](#)
- Hospitality [10-30](#)
- Hunt Group [5-158](#)

## I

---

- Intercom Group [5-175](#)
- Inter-Exchange Carrier (IXC) Codes [5-177](#)
- Interface Links [5-179](#)
- Intra-Switch CDR [5-183](#)
- ISDN Numbering — Private [7-93](#)

- ISDN Numbering — Public/ Unknown [7-95](#)
- ISDN TSC Gateway Channel Assignments [7-98](#)
- ISDN-PRI trunk group [7-198](#)

## L

---

- Language Translations [5-193](#)
- Listed Directory Numbers [5-207](#)
- Loudspeaker Paging [5-209](#)

## M

---

- Maintenance-Related System Parameters [5-212](#)
- Modem Pool Group [5-223](#)
- Multifrequency-Signaling-Related System Parameters [5-228](#)
- Music Sources [5-243](#)

## N

---

- Netcon Data Module [6-245](#)
- Network-Facilities [7-100](#)
- Node Number Routing [12-119](#)

## P

---

- Packet Gateway Board [5-246](#)
- PCOL trunk group [7-246](#)
- Pickup Group [5-256](#)
- PRI Endpoint [7-102](#)
- Processor Channel Assignment for R5r Installations [5-248](#)
- Processor Channel Assignment for R5si Installations [5-252](#)
- Processor Interface Data Module [6-246](#)
- Processor/Trunk Data Module [6-243](#)

## R

---

- Reason Code Names [9-211](#)
- Remote Access [5-258](#)
- Remote Call Coverage Table [5-263](#)
- RHNPA Table [8-76](#)
- RLT trunk group [7-252](#)
- Route Pattern form [8-67](#)

## S

---

- Second Digit Table [5-264](#)
- Security-Related System Parameters [5-266](#)
- Signaling Group [7-106](#)
- SIT Treatment for Call Classification [9-212](#)
- Synchronization Plan [7-112](#)
- System Parameters Country-Options [5-271](#)
- System Parameters Customer-Options [5-277](#)
- System Parameters OCM Call Classification [5-289](#)
- System Port Data Module [6-248](#)

## T

---

- Tandem trunk group [7-257](#)
- Telecommuting Access [5-291](#)
- Tenant [5-292](#)
- Terminal Parameters [6-9](#)
- Terminating Extension Group [5-295](#)
- Tie trunk group [7-262](#)
- Time of Day Coverage Table [5-298](#)
- Time of Day Routing Plan [8-78](#)
- Toll Analysis [5-299](#)
- Trunk Groups — General [7-115](#)

## U

---

- Uniform Dial Plan [12-121](#)
- User Defined Adjunct Names [5-303](#)

## V

---

- Vector Directory Number [9-214](#)
- Vector Routing Table [9-219](#)
- VuStats Display Format [9-221](#)

## W

---

- WATS trunk group [7-268](#)
- World Class BRI Data Module [6-255](#)

## X

---

- X.25 Data Module [6-249](#)

# About This Document

---

## Overview

---

This document describes the DEFINITY Enterprise Communications Server (ECS) Release 6 and includes all incremental releases up to and including Release 6.2. For details about changes in Release 6.1, refer to [Appendix A, "Transition Reference"](#) in this manual. You may also want to refer to the DEFINITY ECS 6.1.0 Change Description.

### NOTE:

This book contains information previously contained in the *DEFINITY ECS Feature Description* and *DEFINITY ECS Implementation* books.

DEFINITY ECS is a family of cost-effective digital communication systems. These systems:

- Route voice and data information between various endpoints (telephones, terminals, computers)
- Provide highly robust networking capabilities
- Include an extensive set of standard features: attendant consoles, voice processing interface, call coverage, DS1 (T1 and E1) connectivity, hospitality support, recorded announcement, and trunk-to-trunk transfer
- Provide flexibility and allow for the addition of optional features and/or upgrades to the system as business needs change

## Purpose

---

This document explains the features that comprise DEFINITY ECS. It provides an introduction to each feature and presents required forms for administration, detailed descriptions, considerations, and interactions between features. This

document provides an overall reference for planning, operating, and administering your DEFINITY ECS. Hardware required for specific features is presented in [Appendix A](#).

This document includes the forms required to implement DEFINITY ECS and descriptions of the fields along with valid values and ranges for each field.

This document is not procedural. It does not contain information about how to install, maintain, repair, or troubleshoot the switch. Refer to [Appendix C](#) for a list of related DEFINITY ECS documents.

## Audience

---

This document is intended for the DEFINITY ECS system administrators and managers, end-users interested in information about specific features, and Lucent Technologies support personnel responsible for planning, designing, configuring, selling, and supporting the system.

## Reason for reissue

---

This document is updated to include DEFINITY ECS Release 6.2 information.

## How to use this document

---

This document is designed to be used as a reference document. If you are interested in information about a particular feature, use the index or table of contents to locate the page number where the feature is described. Forms also can be located this way. They are listed alphabetically in each chapter in the table of contents. The title that appears on the form is the form name.

## Organization

---

This document is organized into chapters by subject. Features are in alphabetical order within each chapter. Pertinent forms follow the features. Basic features and forms are presented in a chapter with the same title. The document includes:

[Chapter 1, “Before You Begin”](#) describes the Communications Survey for gathering system information: its users, their job functions, and their communications needs. It also provides an administration sequence.

[Chapter 2, “System Basics”](#) tells you how to log on, log off, enter commands, set user permissions, print, and use the management terminal. It provides instructions for remote administration and system backup.



**[Chapter 3, “System Security”](#)** describes security practices you should follow and lists the features requiring special measures to secure them from unauthorized use. (You can also consult the index under “Security Measures.”)

**[Chapter 4, “Basic Features”](#)** contains feature-by-feature descriptive and administrative information. These features comprise the core group of DEFINITY ECS features.

**[Chapter 5, “Basic Forms”](#)** contains all of the forms required to administer basic features, descriptions of the fields on each form, and special notes about usage.

**[Chapter 6, “Voice Terminal, PC Interface, and Data Module Administration”](#)** contains all of the voice terminal, PC interface and data module forms and administration in one convenient, easy to use location.

**[Chapter 7, “Trunk Group Administration”](#)** contains all of the trunking features and associated forms necessary to administer trunks. DS1, ISDN, and related features. All trunk group forms are included.

**[Chapter 8, “Automatic Routing”](#)** contains the AAR and ARS features. It includes other features and forms that support automatic routing.

**[Chapter 9, “Call Center”](#)** contains the Call Center features and the forms required to administer these features.

**[Chapter 10, “Hospitality”](#)** contains the Hospitality features and the form required to administer these features.

**[Chapter 11, “Multimedia”](#)** contains the Multimedia features and the forms required to administer these features.

**[Chapter 12, “Private Networking”](#)** contains the Private Networking features and the forms required to administer these features. Included are DCS, QSIG, and Uniform Dial Plan.

**[Appendix A, “Transition Reference”](#)** provides a list indicating new and enhanced features for Release 6.1 and briefly describes Release 6.1 feature enhancements.

**[Appendix B, “Administration Commands”](#)** contains the commands you use to administer DEFINITY ECS features, functions, and services. The use of an abbreviated command structure is discussed as are special command line functions.

**[Appendix C, “References”](#)** provides a list and brief descriptions of reference documents.

“[Glossary and Abbreviations](#)” provides a glossary and list of abbreviations for this and other related DEFINITY ECS documents.

“[Index](#)” provides an index for the entire document.

## Feature-related information

The information for each feature is usually presented under five headings:

- **Feature title**

Gives the name and a brief overview of the feature. Tells what it does or how it serves the system.

- **How to administer**

Provides a list of the forms that are used to administer a feature. Required fields on these forms also are identified.

- **Detailed description**

Provides more detailed, technical information about a feature. When appropriate, additional guidelines and examples are provided. In some cases, expanded technical information is provided on one or several aspects of the feature.

- **Considerations**

Discusses the applications and benefits of a feature and any other factors to be considered when using the feature.

- **Interactions**

Lists and briefly discusses other features that may significantly affect a feature. Interacting features are those that:

- Depend on each other — if one of the features is provided, the other also must be provided.
- Cannot coexist — if one of the features is provided, the other cannot be provided.
- Affect each other — the normal operation of one feature modifies, or is modified by, the normal operation of the other feature.
- Enhance each other — the features, in combination, provide improved service to the user.

## Conventions used in this document

This document uses the following conventions:

 **NOTE:**

Draws attention to information that you must heed.

 **CAUTION:**

*Denotes possible harm to software, possible loss of data, or possible service interruptions.*

 **WARNING:**

*Denotes possible harm to hardware or equipment.*

 **SECURITY ALERT:**

*Indicates when system administration may leave your system open to toll fraud.*

## Trademarks and service marks

The following are trademarks or registered trademarks of Lucent Technologies:

- 5ESS™, 4ESS™
- AUDIX®
- Callvisor®
- Callmaster®
- CentreVu™
- CONVERSANT®
- DEFINITY®
- DIMENSION®
- MERLIN®
- VOICE POWER®

The following are trademarks or registered trademarks of AT&T:

- ACCUNET®
- DATAPHONE®
- MEGACOM®
- MULTIQUEST®
- TELESEER®

The following are trademarks or registered trademarks of other companies:

- Ascend® (registered trademark of Ascend, Inc.)
- Audichron® (registered trademark of the Audichron Company)
- MS-DOS® (registered trademark of the Microsoft Corporation)

- MicroChannel<sup>®</sup> (registered trademark of IBM Systems)
- MULTIQUEST<sup>®</sup> (registered trademark of Telecommunications Service)
- PagePac<sup>®</sup> (trademark of the Dracon Division of the Harris Corporation)
- PictureTel<sup>®</sup> (registered trademark of PictureTel Corporation)
- ProShare<sup>®</sup> (registered trademark of Intel Corporation)
- UNIX<sup>®</sup> (trademark of the Novell Corporation)
- Zydacron (registration pending for Zydacron Corporation)

## **How to get help**

For those times when you need additional help, the following help services are available. You may need to purchase an extended service agreement to use some of these help services. See your Lucent Technologies representative for more information.

- Lucent Technologies Centers of Excellence
  - Asia/Pacific  
65-872-8686
  - Western Europe/Middle East/South Africa  
441-252-391-889
  - Central/Eastern Europe  
361-270-5160
  - Central/Latin America/Caribbean  
1-303-538-4666
  - North America  
1-800-248-1111
- DEFINITY Helpline  
1-800-225-7585
- Lucent Technologies Toll Fraud Intervention  
1-800-643-2353
- Lucent Technologies National Customer Care Center Support Line  
1-800-242-2121
- Lucent Technologies Corporate Security  
1-800-822-9009

## **How to make comments about this document**

---

We provide reader comment cards at the back of this document. While we have tried to make this document fit your needs, we are interested in your suggestions for improving it and urge you to complete and return a reader comment card. If the reader comment cards have been removed from this document, please send your comments to:

Lucent Technologies  
Product Documentation Group  
Room 22-2H15  
11900 North Pecos Street  
Denver, CO 80234-2703 USA

About This Document

*How to make comments about this document*

*Page xxxviii*

# Before You Begin

# 1

---

## Overview

This chapter contains guidelines to help you get ready to administer your system. Before you do this, you should attend the customer training system administration course. You should have thorough training on the following items before attempting to administer the system:

- System and voice terminal features
- Hardware requirements
- Port assignments
- Management terminal operation

---

## Communications survey

Before you begin to administer your DEFINITY ECS, complete the following communications survey. This task consists of gathering information about the system, its users, their job functions, and their communications needs. After you identify this information, you can match it to the available features and hardware to design a system that fulfills your requirements.

Basically, the survey:

- Identifies the appropriate features and calling privileges for each user
- Assigns appropriate data on hard-copy forms that subsequently become part of the system's software database

Before you begin the survey, do a quick review of the information provided in the rest of this book. "[About This Document](#)" provides an overview of the contents of the remaining chapters, and is a good place to start.

Complete each of the survey steps in the order given. Depending on the offer definition, some steps are best performed as a cooperative effort between you and your Lucent Technologies account team.

Become familiar with the features, the forms required, and the data to be entered on the forms. Some of the steps in this survey ask you to gather information using duplicates of forms from the system. These forms are available in either *DEFINITY Enterprise Communications Server Implementation Blank Forms* or *DEFINITY Enterprise Communications Server Administration and Feature Description*. You can use these forms as a guide when you actually administer the system.

The following documents provide additional information:

- *DEFINITY Enterprise Communications Server Release 6 System Description Pocket Reference*
- *DEFINITY Communications System Generic 3 Planning and Configuration*
- *DEFINITY Enterprise Communications Server Release 6 — Installation and Test for Single-Carrier Cabinets* or *Installation and Test for Multi-Carrier Cabinets*

## **Step 1 — Equipment and feature list**

---

- Obtain a list of equipment (including number and type) that has been ordered for the system. Identify the system cabinets ordered.
- Find out what features and services are to be provided.

## **Step 2 — Port assignment records and Circuit Pack forms**

---

See *DEFINITY Communications System Generic 3 Planning and Configuration* for information about how to complete port assignment records for the system. For information about how to complete the Circuit Pack forms, see [Chapter 5, “Basic Forms”](#). You will need this data to complete the feature and network forms covered in this manual.

## **Step 3 — Trunk groups**

---

You can have a variety of trunk types connected to your system. One or more trunks of a particular type make up a trunk group. A complete list of all trunk groups supported by the system appears below. For each trunk type you will use, review the associated trunk group description in this book. Identify the associated trunk group forms required and the fields on the forms to be completed. Complete the appropriate fields on all forms as required.

- Access
- Advanced Private Line Termination (APLT)



- CAMA - E911
- Centralized Automatic Message Accounting (CAMA/E911)
- Central Office (CO)
- Customer-Provided Equipment (CPE)
- Digital Multiplexed Interface Bit-Oriented Signaling (DMI-BOS)
- Direct Inward Dialing (DID)
- Direct Inward Outward Dialing (DIOD)
- Foreign Exchange (FX)
- Integrated Services Digital Network (ISDN)
- Personal Central Office Line (PCOL)
- Release Link Trunk (RLT)
- Tandem
- Tie
- Wide Area Telecommunications Service (WATS)

#### **Step 4 — Optional feature software**

Many features are optional and may or may not be purchased with your system. To enable optional features, a representative of Lucent Technologies must complete the System-Parameters Customer-Options form. You can view this form to determine which optional features are active on your system. Once you know this, you can assemble the information necessary to administer these features.

For each optional feature you need to administer, review the feature description in this book. Identify the associated system forms and the fields on the forms to be completed, and determine the number of forms required. Complete the appropriate fields on the duplicated forms as required.

#### **NOTE:**

You cannot access forms or fields on forms associated with an optional feature that is not activated.

#### **Step 5 — Remaining system features and services**

For each feature you need to administer, review the feature description in this book. Identify the associated system forms and the fields on the forms to be completed, and determine the number of forms required. Complete the fields on the duplicated forms as required.

As you proceed, there will be times when the data for a field on a form has not yet been identified. For those cases, note the fields requiring completion and then proceed. Later, complete the form when the applicable data is identified.

## Step 6 — End-user survey

---

Establish contact with a representative from each department, section, or work group that will be using the system. Each person selected must have the authority to make some decisions about the new communications system. You will need to interview these contacts as you go about the process of completing the system forms.

Identify each system user name, terminal type, and extension number to be assigned.

If required, enter each user name, terminal type, and extension number on a floor plan, or equivalent drawing. The floor plan will help you visualize various work groups and make later group assignments such as call-answering groups or call-pickup groups easier. This drawing, or an equivalent, can then be used by the installation technicians when installing voice terminals and associated equipment.

For all terminal types and quantities of each type identified, remove the applicable blank station forms from *DEFINITY ECS Implementation Blank Forms* and duplicate as many times as necessary.

On each duplicated station form, enter the applicable terminal type, user name, extension number, and port number.

## Step 7 — Group forms

---

For each of the following features to be provided, review the associated description in this book, identify the associated forms and the fields on the forms to be completed, and determine the number of forms required. Remove the applicable blank station forms from *DEFINITY ECS Implementation Blank Forms* or *DEFINITY ECS Administration and Feature Description* and duplicate as many times as necessary.

- Abbreviated Dialing List — System List
- Abbreviated Dialing List — Group List
- Abbreviated Dialing List — Personal List
- Abbreviated Dialing List — Enhanced List
- Call Coverage
- Hunt Groups
- Intercom Groups — Automatic and Dial
- Malicious Call Trace
- Pickup Group
- Terminating Extension Group

## **Step 8 — Voice terminals**

---

Complete the various fields on the previously obtained station forms. Before actually assigning features on the forms, review the features that can be assigned to each terminal type, the recommended button names, and the abbreviated feature name that must be entered on the form. You also need to consider the maximum number of buttons that can be assigned to a feature or function.

Voice terminal figures in this book show each terminal that can be assigned, their associated button positions, and a suggested standard button arrangement. The maximum number of buttons that can be assigned features (administrable buttons) is shown for each terminal type. You must not exceed this number when assigning feature buttons to the terminal.

A set of preprinted labels comes with each voice terminal. After you make button assignments, be sure to insert the labels next to the appropriate button.

## **Step 9 — Review**

---

Review all the features and services that you will use and ensure that you have completed forms for all features and services to be provided.

Retain all completed forms for use during system initialization.

## **Administration sequence**

---

After the system is installed and you have completed the communications survey, you must enter the data into system memory. [Chapter 2, "System Basics"](#), provides information about how to login and how to use the system administration terminal (SAT).

Obtain all duplicated forms from the survey and sort them into groups. For example, separate the forms for all voice terminals, hunt groups and trunk groups. Have a copy of the port-assignment record available to keep track of the items as you install them.

## **Record keeping**

---

Record keeping plays a vital role in system administration. Records provide a current status of what hardware and which features have been installed.

The port assignment record provides a record of how a system is initialized and administered. Ports are the physical location on a circuit pack where terminals, trunks, or system adjuncts are connected. Once port numbers are assigned, they become the address of the associated equipment or facility in the system. It

is necessary that a record be made and kept of port assignments for system installation/initialization and ongoing administration.

Use a work request form or worksheet to keep track of who has requested features and the features they desired. Follow your company policy concerning keeping records.

## Entering translations

Translations tell the system how you want things to be in your particular system. For example, a user's name, extension, terminal type, class of restriction, and port number are all translations that are specific to your system. Everything you do to make the system meet your needs is a translation.

When entering this information into the system, you should periodically save the translations. This creates a nonvolatile copy of the translations you have already entered into the system. Then if a power outage or system failure occurs, you will not need to retype each translation.

You should enter the system translations in an ordered manner. The following is the recommended order:

1. Login and password (change password, if necessary)
2. Dial Plan
3. Feature Access Codes
4. System Features (Class of Service and Class of Restriction)
5. Console Parameters
6. Attendant Consoles
7. System Parameters
8. Voice Terminals
9. Data Modules
10. Netcon Channels
11. Groups (hunt groups, pickup groups, etc.)
12. Trunk Groups
13. Automatic Route Selection
14. Administered Connections

## **Login and password**

Once you have all the forms together, you can log in to the system. For security reasons, it is a good idea to change your password at this time. For login process, see ["Login to the SAT" on page 2-3.](#)

## Establish a Dial Plan

You must administer the Dial Plan and Feature Access Codes (FACs) before you can administer voice terminals, hunt groups, pickup groups, coverage groups, and attendant consoles. You can change the default values for the Dial Plan if they do not meet business requirements.

## Feature Access Codes

The FAC form contains default values, which you may change to meet your business requirements. The number of digits assigned to the FAC must agree with the Dial Plan.

## System Features

System features include the Class of Service (COS) and Class of Restriction (COR). You cannot add these features, but you can change them.

## Console Parameters and Attendant Consoles

Attendant consoles must be added one at a time. A vacant port on a digital line circuit pack is required for each attendant console used. For reliability, attendant consoles should not be assigned to the same circuit pack.

## System Parameters

System parameters allow you to assign values for system-related features such as Leave Word Calling (LWC), Hospitality Features, and Call Detail Recording (CDR).

## Voice Terminals

Once you have established the Dial Plan and FACs, you can add voice terminals. The **duplicate** command can be used to add the same types of voice terminals. The extension number, location, type, and user name should be entered on the form.

## Data Modules

You can assign data modules after voice terminal administration, or at the same time, if the voice terminal has a data module.

## Netcon Channels/SAPs

Netcon channels provide switched data access for the following:

- Call Detail Recording (CDR)
- On-premises administration/maintenance terminal
- Remote administration/maintenance terminal

- Property Management System (PMS) Link
- PMS Log Printer
- Journal Printer
- Recorded Announcements
- System Printer

Netcon channels are assigned by entering the command **add data-module (extension number or next)** and then entering **Netcon** in the `Type` field. Up to four Netcon channels can be assigned. The channels can be added by entering the command **duplicate data-module xxx (extension number to be duplicated)**.

## Groups

After you have administered the voice terminals, you can administer the following items using the **add** commands:

- Abbreviated Dialing (System, Group, Enhanced)
- Hunt Groups
- Call Coverage Answer Groups
- Pickup Groups
- Intercom Groups
- Terminating Extension Groups

## Trunk groups

Your account team should help you determine what information you need to complete the trunk group forms. See [“Trunk Group Administration” on page 7-1](#) and [“Private Networking” on page 12-1](#) for more information.

## System Basics

# 2

---

### Overview

---

This chapter provides basic information you need to manage your DEFINITY Enterprise Communications Server (ECS). This includes how to log in and log off, how to add and remove logins, how to set permissions for others who use the administration terminal, and how to back up the information you administer.

If you use the DEFINITY Communications System Generic 3 Management Applications (G3-MA) to administer your system, see *DEFINITY Communications System Generic 3 Management Applications Operations*, for system management procedures.

### The system administrator's role

---

As system administrator, you are responsible for the following:

- Adding, changing, removing, and monitoring the system and voice terminal features on a day-to-day basis
- Performing system backup procedures
- Monitoring system performance
- Maintaining system security

## **The system administration terminal**

Your DEFINITY ECS comes equipped with a system administration terminal (SAT) that consists of a monitor and a keyboard. You use the SAT to configure your system, to change system settings, and to monitor system performance. Maintenance personnel may also use the SAT to perform testing and maintenance operations.

The system can be equipped with one of several different terminal types, including the following:

- 715 Multi-Task (MT) terminal
- 513 BCT
- 610 BCT
- 615 MT terminal
- 4410 terminal
- 4425 terminal
- Personal Computer (PC) using a 513, 4410, or 4425 emulation software package
- DEC VT220

### **Terminal emulation**

Some terminals can emulate other terminal types. You need to use terminal emulation if you use a PC. See the documentation that came with the terminal to determine how you should set it up.

### **Programmable keys**

Some keyboards are equipped with programmable function keys, often called user PF keys. You can program a key to automatically type a command on the command line, such as add station next, or duplicate station. You may then need to type additional qualifiers, such as an extension. See your terminal documentation to see if you can do this.

## **How to log in and log off**

Before you can perform any system administration commands or functions, you must successfully log in to the system. When you are not using the system, you should log off for security purposes.



## Login to the SAT

---

1. Turn on the monitor, if required. The `Login:` prompt appears.
2. Enter your login name and press RETURN.

Some keyboards have two keys labeled ENTER and none labeled RETURN. These keys do not have the same function. Where this document says to press RETURN, press the ENTER key next to the alphabet keys. Where this document says to press ENTER, press the ENTER key on the number pad.

The `Password:` prompt appears.

3. Enter your password and press RETURN.

For security reasons, your password does not display as you type it. The system verifies a valid login and password name were entered. If you entered an invalid login or password name, the system responds with `INCORRECT LOGIN` and the `Login:` prompt reappears for you to try again.

4. If the system recognizes the login and password name,

```
Terminal Type (Enter 513, 715, 4410, 4425, or VT220):  
[ 513 ]
```

displays on the screen.

5. If your terminal is a 513 or emulates a 513 terminal, simply press RETURN to accept the default. If your terminal is anything other than a 513, type in the terminal type or the type your system emulates, then press RETURN.

### NOTE:

If you accidentally enter the wrong terminal type, it can lock up your system. Type **newterm (correct terminal type)** and press ENTER. If this does not work, turn the power off **ON THE TERMINAL ONLY**. The terminal reboots and you can login again.

6. The `Command:` prompt appears.

## Logoff of the SAT

---

You should logoff the system any time you are not using the SAT. To log off the system, at the `Command:` prompt, type **logoff** and press RETURN. The system automatically disconnects you from the system.

## Logoff notification

If you attempt to logoff while a facility test call or remote access is active, and logoff notification is enabled for your login, the logoff notification screen appears. You need to respond to the `Proceed with Logoff` prompt on the logoff screen. The response defaults to `n`; type `y` to override the default.

```
Facility Test Call Administered
Remote Access Administered

Proceed with Logoff? [n]
```

### Screen 2-1. Logoff Notification Screen

#### SECURITY ALERT:

*To logoff with the Facility Test Calls feature access code administered poses a significant security risk.*

*To logoff with Remote Access administered poses a significant security risk if you are using the feature in conjunction with Facility Test Calls.*

A notification screen also appears if you attempt to logoff while alarm origination is disabled. If you do this and the system generates an alarm, Lucent support services will not receive any notification of the alarm. See *DEFINITY Enterprise Communications Server Release 6 Maintenance for R6r* or *DEFINITY Enterprise Communications Server Release 6 Maintenance for R6vs/si* or *DEFINITY Enterprise Communications Server Release 6 Maintenance for R6csi*.

## Using the SAT

---

The DEFINITY ECS administration terminal is easy to use. When in doubt, press HELP.

## Help

---

At any point on the command line, or when your cursor is in a field on a form, you can press the Help key to see a list of available commands or entries. If the level requires a particular keyword (that is, the level is an Action or Object level), a list of the valid keywords at that level is displayed. If the level is the Qualifier level, a message is displayed describing the format and the type of parameter required at that level. Brackets ([ ]) around keywords or qualifiers indicate that the keyword, qualifier, or the part of the qualifier enclosed in the brackets is optional.

The system only displays those commands and objects that you have permission to use and that are relevant to your system configuration.

## Display screen format

---

For the command line interface, the display screen is made up of 27 lines of 80 characters each. The screen is partitioned as follows:

|              |   |
|--------------|---|
| Line 1       | Line 1 is the command path line and displays the command you entered to view the current form, the active switch processing element in duplicated systems, and the page number. |
| Lines 2–22   | These lines display command output and multiline help messages.   |
| Line 23      | This line is the message line and displays single-line help and error messages.   |
| Line 24      | This line is the command line, where commands appear as you type.   |
| Lines 26, 27 | These lines display the functions of screen-labeled programmable keys. Normally, these lines are blank.   |

## SAT function keys

---

Some special keys perform certain functions within the system. These keys may be labeled with a name (CANCEL, HELP) or they may be labeled F1, F2, etc. If your keys are not labeled, you should have a legend at the bottom of the screen to tell you what key to use for each function.

- **Cancel** — Pressing CANCEL on the command line cancels the command, and clears the command line. When the cursor is in a form, CANCEL returns the cursor to the command line, and the system ignores any changes you made to the form.
- **Character Erase** — The BACKSPACE key erases the character to the left of the cursor and moves the cursor to that position. If the cursor is at the first position, BACKSPACE causes the terminal bell to ring.
- **Help** — Pressing the HELP function key displays a list of valid keywords for the current level or a message describing the format and the type of parameter expected at this level.
- **Word Delete** — The BACKTAB (shift-tab) key erases the last word typed on the command line. If there are no words on the command line, word delete backs up one level along the hierarchical command structure.

- **Command Line Terminator** — Pressing RETURN or TAB from the command line enters the current command into the system. If the cursor is in a form, these keys move the cursor to the next field.  
  
Some keyboards have two keys labeled ENTER and none labeled RETURN. These keys do not have the same function. Where this document says to press RETURN, press the ENTER key next to the alphabet keys. Where this document says to press ENTER, press the ENTER key on the number pad.
- **Print** — Typing **print** as part of a display or list command allows you to print all or part of the translation data of the specified object at a slave printer. If the “print” option is entered as part of other commands, the system returns an error message and a prompt for a correct command.
- **Direct Page Access** — When a multipage form is being displayed, the user may skip directly to any page by pressing the OPTS key (this is labeled GO TO PAGE on a 715) and entering the desired page number, rather than by using the “Page” key to advance to the desired page.
- **Repeat Last Command** — Typing **R** at the command prompt causes the previously executed command line to be re-displayed with the cursor positioned at the end of the line. You can execute the command “as-is” by simply pressing the RETURN key, or edit the command using the Word Delete functions described above.
- **Cursor keys** — The cursor keys allow you to move the cursor between fields and pages on a screen form. The cursor must be positioned in a field before you can change information in that field.

## Commands

---

Commands are grouped into the following four categories:

- **Administration** — Used to administer data associated with terminals, facilities, and system parameters. [Appendix C](#) contains a list of Administration commands and their associated objects. Note that not all commands are available to all logins.
- **Maintenance** — Used to perform maintenance and testing on trunks, terminals, ports, and system control modules. Also used to obtain displays of error and alarm logs. See *DEFINITY Enterprise Communications Server Maintenance* manuals for information associated with maintenance commands.
- **Measurements** — Used to obtain displays of measurement reports for trunk groups, hunt groups, attendants, etc. See *DEFINITY Enterprise Communications Server System Monitoring and Reporting* for information associated with measurement commands.
- **System** — Used to change passwords and administer the command authorization structure. This chapter discusses these commands.

You must be logged onto DEFINITY ECS before you can enter commands. The DEFINITY ECS is case-sensitive. Always enter commands in lowercase, unless a name, login-ID or password contains uppercase characters.

## Command structure

A command consists of *Action*, *Object*, and sometimes *Qualifier* words that instruct the system to do a specific task.

The Action is the first word you enter on the command line and specifies the operation to be performed (such as, add, change, or delete). The Object is the second word you enter and specifies the object to be operated on, for example, a station, trunk group, or hunt group. Finally, the qualifier can be one or more key words or digits that further identify or complete the object. The qualifier may be mandatory or optional, depending on the command or system configuration.

You can enter only one command at a time. For example, the command required to add a station with extension number 1212 is shown below:

*add station 1212*

In the above example, *add* is the Action word, *station* is the Object word, and *1212* is the Qualifier word.

You must separate each Action, Object, and Qualifier word with spaces.

## Command abbreviation and keyword entry

In most cases, you do not need to type every character of a command. You can type a shortened form of the command, as long as what you type is unique to the command.

For example, for the command line **change station 3600**, you could type **ch st 3600**. If the character string you enter is not unique, an error message appears. For example, if you type **dis** for the command display, the system replies with `'dis' is an ambiguous entry` and a list of all the possible commands that start with dis. At this point, you only need to add the p to the abbreviation to form *disp*, an entry that is not ambiguous.

## Login administration

When your DEFINITY ECS is delivered, one customer super-user login and password combination is already defined. You must administer additional logins and passwords if needed. If you are the super-user, you have full customer permissions and can customize any login you create. The maximum number of customer logins is 11.

As super-user, you can establish permissions for the other logins in your system. You can block access to any object that may compromise switch security.

**⇒ NOTE:**

You cannot use a shortened form of the login ID for any of the following actions.

The following login administration commands are available.

| Action  | Object      | Qualifier                             |
|---------|-------------|---------------------------------------|
| add     | login       | xxxxxx (login-ID)                     |
| change  | login       | xxxxxx (login-ID)                     |
| change  | permissions | xxxxxx (login-ID)                     |
| display | login       | xxxxxx (login-ID) [print or schedule] |
| display | permissions | xxxxxx (login-ID) [print or schedule] |
| list    | logins      |                                       |
| remove  | login       | xxxxxx (login-ID)                     |

### To add a login

To add a customer login you must be a super-user with authority to administer permissions. To establish a login, first use the Login Administration form. Once the login is established, set permissions using the Command Permission Categories form.

If you are adding a login, enter the new login name as part of the add command. The name must be 3–6 characters, and can contain the characters 0-9, a-z, A-Z.

If you add or remove a login, the “Security Measurement” reports are not updated until the next hourly poll, or you type the **clear measurements security-violations** command.

```

                LOGIN ADMINISTRATION

Password of Login Making Change:

LOGIN BEING ADMINISTERED
                Login's Name:xxxxxxx
                Login Type:
                Service Level:
Disable Following a Security Violation?
                Access to INADS Port?

LOGIN'S PASSWORD INFORMATION
                Login's Password:
                Reenter Login's Password:
Password Aging Cycle Length (Days):

LOGOFF NOTIFICATION
Facility Test Call Notification? y      Acknowledgment Required? y
Remote Access Notification? y          Acknowledgment Required? y
```

## Screen 2-2. Login Administration form

This form contains the following fields.

- **Password of Login Making Change** — You must enter your password in order to change any field on this form.
- **Login's Name** — Displays the login name you assigned when you entered the add login command.
- **Login Type** — Indicates whether this login belongs to a customer or to Lucent services personnel. The default and only valid value for customer logins is customer.
- **Service Level** — Indicates whether this user has super-user or non-super-user permissions. Default is non-super-user. You cannot change your own service level.
  - The super-user login has access to the **add, change, display, list,** and **remove** commands for all customer logins and passwords. The super-user can administer any mix of super-user and non-super-user logins, up to a total of eleven customer logins.
  - “Non-super-user” permissions are limited by restrictions specified by the super-user when administering the non-super-user login. A non-super-user can change his/her password with permission set by the super-user, however once a password has been changed the non-super-user must wait 24 hours before changing the password again. A non-super-user cannot change other user passwords, login characteristics, or permissions.

- **Disable Following a Security Violation** — Enter **y** (default) to disable this login following a login security violation. This field only appears when the SVN Login Violation Notification feature is enabled.
- **Access to INADS Port** — Enter **y** to allow access to the remote administration port. This field only appears if Lucent Technologies has enabled customer access to the INADS Remote Administration Port. Default is **n**.
- **Login's Password** — You must assign the initial password for this login. The owner of the login should change the password immediately. Passwords must be 4–11 characters in length and contain at least 1 alphabetic and 1 numeric character. Valid characters include numbers, and !&\*?;'^ ( ),.- The password does not display on the screen as you type.
- **Re-enter Login's Password** — The login's password as above, for verification. The password does not display on the screen as you type.
- **Password Aging Cycle Length** — For security purposes, you should assign password aging to all logins. Enter the number of days that the password will remain valid. The system tracks a password from the day the login was created or the day the user last changed the password. If you enter a blank in this field, password aging does not apply to the login. Default is blank.
- **Facility Test Call Notification** — If this field is **y**, the user receives notification at logoff that the facility test call feature access code is administered. Default is **y**. For security purposes, this field should be **y** for all logins.
- **(Facility Test Call Notification) Acknowledgment Required** — If this field is **y**, the user is required to acknowledge that he or she wishes to logoff while Facility Test Call is still administered. Default is **y**.
- **Remote Access Notification** — If this field is **y**, the user receives notification at logoff that remote access is still administered. Default is **y**. For security purposes, this field should be **y** for all logins.
- **(Remote Access Notification) Acknowledgment Required** — If this field is **y**, the user is required to acknowledge that he or she wishes to logoff while remote access is still administered. Default is **y**.

## To change a login's attributes

To change a customer login's attributes you must be a super-user, and have administration permissions.

1. Enter the command **change login (login-ID)** to access the Login Administration form. Make any necessary changes and press ENTER to record the changes in the system.



## To display a login

To display a specific login:

1. Enter the command **display login (login-ID)** and press the Enter key.

The system displays the Login Administration form with all information about the requested login except the password.

## To list logins

To list all of the system logins and the status of each login, enter the command **list logins**.

The system displays the following information for all current logins:

- Name
- Service level
- Status (active, inactive, disabled, svn-disabled, void)
- Password aging cycle length

The system displays only those logins with the same, or lower, service level as the user making the request.

## To remove a login

To remove a login from the system, you must use a super-user login:

1. Enter the command **remove login (login-ID)**.

The system displays the Login Administration form with all information about the requested login except the password.

2. Press ENTER to remove the login, or press CANCEL to cancel the procedure without removing the login.

## Forced password aging

Password aging is an option that you can activate while administering logins. The password for each login can be aged starting with the date the password was created, or changed, and continuing for a specified number of days (1 to 99).

The user is notified at the login prompt, 7 days before the password expiration date, that the password is about to expire. When the password expires, the user must enter a new password into the system before logging in. Once a non-super-user has changed his or her password, the user must wait 24 hours to change the password again.

```
      Login: telmgr

      Password:
      Your Password has expired, enter a new one.

      Reenter Current Password:

              New Password:

      Reenter New Password:
```

### Screen 2-3. Change Password screen

#### Command permission categories

Once you have created a login, you can modify the permissions associated with the login. The system maintains default permissions for each level of login, but you may want to further restrict the login, or at least make sure the defaults are appropriate for the user. The default values for these fields vary based on the login type.

When set to **y**, the permissions on this form apply for any object that is not restricted. The second and third pages of the Command Permission Categories form allow you to restrict the user from any access to specified objects. To access this form, use the command **change permissions (login-ID)**.

```

                                                                    Page 1 of 3
                                COMMAND PERMISSION CATEGORIES
                                Login Name: Sup3ru

COMMON COMMANDS
    Display Admin. and Maint. Data? y
    System Measurements? y

ADMINISTRATION COMMANDS
    Administer Stations? y           Administer Features? y
    Administer Trunks? y           Administer Permissions? y
    Additional Restrictions? n

MAINTENANCE COMMANDS
    Maintain Stations? n           Maintain Switch Circuit Packs? n
    Maintain Trunks? n           Maintain Process Circuit Packs? n
    Maintain Systems? n           Maintain Enhanced DSL? n
```

### Screen 2-4. Command Permission Categories (Page 1 of 3)

- **Login Name** — This field displays the login to which these permissions apply.
- **Display Admin. and Maint. Data** — Users with this permission can use display, list, monitor, status and schedule (reports) commands. They can also change their own passwords, and schedule reports.
- **System Measurements** — Users with this permission can use the list measurements commands. This field only appears for vs/si systems.
- **Administer Stations** — Users with this permission can add, change, duplicate or remove stations, data modules and associated feature, such as abbreviated dialing, vectors and routing tables.
- **Administer Features** — Users with this permission can administer feature-related parameters, such as coverage paths, class of service, class of restriction, system parameters, authorization codes and security. Use caution when assigning this permission to a user.
- **Administer Trunks** — Users with this permission can administer AAR/ARS, trunk groups, remote access and route patterns. This permission should only belong to users who are very familiar with these features.
- **Administer Permissions** — Users with this permission can administer logins and command permissions. This permission only applies to super-user logins.
- **Additional Restrictions** — If this field is **y**, the second and third pages of this form appear. You can use these pages to add up to 40 objects that this user cannot manipulate. If an object appears on the Additional Restrictions page, users cannot display, add, change, or do anything with that object.
- **Maintain Stations** — You can only enter **y** in this field if `Station` and `Trunk MSP` is **y** on the System-Parameters Customer-Options form. Allows users to perform station maintenance.
- **Maintain Switch Circuit Packs** — You can only enter **y** in this field if `Station` and `Trunk MSP` is **y** on the System-Parameters Customer-Options form. Allows users to perform circuit pack maintenance.
- **Maintain Trunks** — You can only enter **y** in this field if `Station` and `Trunk MSP` is **y** on the System-Parameters Customer-Options form. Allows users to perform trunk maintenance.
- **Maintain Process Circuit Packs** — You can only enter **y** in this field if `Processor` and `System MSP` is **y** on the System-Parameters Customer-Options form. Allows users to perform processor maintenance.

- **Maintain Systems** — You can only enter **y** in this field if `Processor` and `System MSP` is **y** on the System-Parameters Customer-Options form. Allows users to perform system maintenance.
- **Maintain Enhanced DS1** — You can only enter **y** in this field if `DS1 MSP` is **y** on the System-Parameters Customer-Options form. Allows users to perform enhanced DS1 maintenance.

Page 2 of 3

COMMAND PERMISSION CATEGORIES  
RESTRICTED OBJECT LIST

|       |       |
|-------|-------|
| _____ | _____ |
| _____ | _____ |
| _____ | _____ |
| _____ | _____ |
| _____ | _____ |
| _____ | _____ |
| _____ | _____ |
| _____ | _____ |
| _____ | _____ |

Screen 2-5. Command Permissions Categories (Page 2)

Pages 2 and 3 of this form are identical, and allow you to specify certain objects that this user cannot access. If you want to limit a user's permissions beyond those on page one, enter the objects in this list. For example, if you want a user to be able to add and change stations, but not VDNs, you can enter **y** in the `Administer Stations` field and the `Additional Restrictions` field. Then on this page, enter `vdn` as a restricted object.

## Remote administration

Remote administration allows the system to be administered from a remote terminal. A local administration terminal is one that is located on-premises within 50 (15.25m) feet of the system cabinet. A terminal located more than 50 feet (15.25m) from the system cabinet is considered remote. A remote administration terminal can be on-premises or off-premises. The remote terminal can perform the same functions as the local terminal.

You can connect several terminals to the system at the same time. These terminals can display information simultaneously, but the system limits the type of simultaneous changes that users can make from any two (or more) terminals. These limitations, and the number of terminals you can connect to a system, are documented in *DEFINITY ECS Release 6 System Description Pocket Reference*.

 **SECURITY ALERT:**

*When logging into the system from a remote location using the asynchronous link, you should not be on the link too long or leave the terminal unattended while logged in. This link is used by the system to transmit alarms and errors to a central maintenance site. A long login session may block reporting of important maintenance information.*

See the *BCS Products Security Handbook* for suggestions on preventing unauthorized access to system ports.

To allow remote administration, you need to establish a remote administration link, and you may need to assign the remote administration extension to a hunt group. The members of this hunt group are the extensions of the data modules available to connect to the SAT. For information about how to do this, find the data module type you are using elsewhere in this book.

To set up the system to allow Remote Administration, do the following:

1. For Release 5vs/si and later configurations, translate all four netcon channels. For Release 5r and later configurations, administer the system access ports.
2. Translate a Uniform Call Distribution (UCD) hunt group using a hunt group form.
  - a. In the `Group Extension` field, enter an extension number. If you use Direct Inward Dialing (DID) for remote administration, enter a DID extension number.

 **SECURITY ALERT:**

*Using DID for remote administration presents a major security risk.*

- b. In the `Group Members Assignment` field, enter the four extension numbers previously assigned to the four netcon channels or system access ports.

If the system will be remotely administered from an on-premises terminal, no additional translations are required. You do not need to administer DID if the remote terminal is on-premises or accessible through DCS.

If the system will be remotely administered from an off-premises location via a dial-up facility, complete Steps 3 and 4.

3. Translate a pooled modem if not translated previously. See [“Modem Pooling” on page 4-449](#) for more information.
      4. Translate a trunk group if not translated previously.

## How to perform remote administration

1. Using either the keyboard or voice terminal, dial the UCD group extension number. This number will be one of the following (see [Table 2-1](#)):
  - a. From off-premises:
    - The DID number, or
    - An LDN (you must use a voice terminal), or
    - The trunk number dedicated to remote administration
  - b. From on-premises:
    - An extension number
2. If a DID number, dedicated trunk number, or extension was dialed, receive data tone or visually receive answer confirmation.

If an LDN was dialed, the attendant will answer. Ask to be transferred to the UCD group extension number. Receive data tone or visually receive answer confirmation. Transfer the voice call to your data terminal.
3. The `Login:` prompt appears.
4. Enter your login and password.
5. Perform system administration.
6. Log off and disconnect.

## Data terminal speed settings

Ensure data terminal speed settings are compatible with the modem pool and the netcon/data channel. Use the table below to determine the data terminal speed setting that you need.

**Table 2-1. Data Terminal Speed Settings**

| Data Terminal                              | Speed        |
|--|--------------|
| Integrated pooled modem circuit pack TN758 | 1200 BPS     |
| Combined modem pools                       |              |
| NETCON data channel                        | Up to 9.6PBS |
| System access ports                        | 9.6 KBS      |

## How to set the system date and time

You use the Date and Time form to set the system date and time. You should always update the date and time for events such as a leap year, daylight savings time, or a system restart after a power failure.

If a time of day is not administered, CDR records are not generated. The correct time and date assure that CDR records are correct for the records being kept. CDR does not work until the time and date have been entered. To set the system time and date:

Enter the command **set time** and press RETURN. The Date and Time form appears.

```
set time                                page 1 of 1
                                     DATE AND TIME
DATE
    Day of the Week: _____      Month: _____
    Day of the Month:  __           Year:  ____
TIME
    Hour:  __                       Second: XX
    Minute: __
```

### Screen 2-6. Date and Time screen

This form contains the following fields:

- **Day of the Week** — Valid values are Sunday–Saturday.
- **Month** — Valid values are January–December.
- **Day of the Month** — Valid values are 1–31.
- **Year** — Valid values are 1990–2099.
- **Hour** — Valid values are 0–23 using the 24-hour clock. For example, if the current time is 2:00 p.m., enter **14**.
- **Second** — Displays the seconds. You cannot update this field. It resets to 0 when you press ENTER.
- **Minute** — Valid values are 0–59.

Verify the date and time by entering the command **display time**.

## How to print on demand

---

When you use the list and display commands, you can either view the information on screen, or redirect the output to a printer. To get a printout of the data, add the word **print** or the abbreviation **pr** to the end of the command. This command prints to the printer connected to the SAT, rather than to the system printer.

For example, the command **display abbreviated-dialing group 20 print** provides a printout of AD group number 20. See *DEFINITY ECS System Monitoring and Reporting* for more information about the system printer and report scheduler.

## System backup for R6vs/si and later configurations

---

### Save and restore Recorded Announcements

---

#### TN750C announcement circuit pack

The TN750C circuit pack contains flash memory which provides internal backup of announcements on the circuit packs. Thus, the TN750C circuit pack does not need the save and restore processes still available for the TN750 and TN750B circuit packs. However, you can use the save and restore processes to copy announcements between TN750B/C circuit packs.

The command syntax for saving from a TN750C circuit pack is:

**save announcements ['from' cabinet(1-X). carrier (A-E), slot (0-20)]**

where X for cabinet is the system maximum and where "slot" is the number of the slot occupied by the circuit pack you want to back up or restore.

The command syntax for restoring to a TN750C circuit pack is:

**Restore announcements [disk | tape ['to' cabinet(1-X). carrier (A-E), slot (0-20)]]**

where X for cabinet is the system maximum and where "slot" is the number of the slot occupied by the circuit pack you want to back up or restore.

If there are multiple circuit packs in your system, you must specify the slot location of the circuit pack. If there is only one circuit pack, the system defaults to the proper location.



When you execute a restore command, you receive a warning message:



**WARNING:**

*WARNING: This restore announcement command will overwrite the specified circuit packs existing announcements.*

## Save translation

To backup the DEFINITY Release 5si/vs and later configurations, you use a memory card. In case of a power failure, the system translations and announcements can be restored using the memory card.

Translation data can be automatically saved every 24 hours, if administered on the System-Parameters Maintenance form. However, if your translation data changes frequently, you should also save translations frequently to assure that you have the most up-to-date information.



**NOTE:**

You should not save translations if memory card alarm conditions occur or if the system is having problems (such as processor, memory, or netcon alarms).



**NOTE:**

Save translations after business hours to prevent dial tone delays. Or, if your business operates 24 hours, save translations during slow business hours.

Use the following procedure to save translations to the memory card:

1. Verify that the memory card is in the Netcon circuit pack.
2. Log in to the administration terminal.
3. Verify that the screen displays the prompt `Command :`
4. Enter **save translation** and press RETURN. This command instructs the system to take all translation information in memory and transfer it into the memory card.

2 System Basics

System backup for R6vs/si and later configurations

Page 2-20

```
save translation                               SPE A
                                           SAVE TRANSLATION

Processor                                     Command Completion Status      Error Code
SPE_A                                         Success                          0

Command successfully completely enter command:
```

Screen 2-7. Save Translation screen — SPEA

5. Verify that the `Success` message appears in the `Command Completion Status` field. If it does not, an error message appears instead.
6. If the system is equipped with an Announcement circuit pack, you can save the recorded announcements using the **save announcements** command. Enter **save announcements** and press RETURN.

```
save announcements
                                           SAVE ANNOUNCEMENTS

Processor                                     Command Completion Status      Error Code
SPE_A                                         Success                          0

Command successfully completely enter command:
```

Screen 2-8. Save Announcements screen — SPEA

7. Verify that the `Success` message appears in the `Command Completion Status` field. If it does not, an error message appears instead.

One memory card is provided with the system. If you also have a backup memory card, replace the existing card with the backup card, and perform the save translation operation. You can also save announcements to the backup memory card. The procedure is the same.

Remove the backup memory card and replace the original card when finished. Label the memory card as a backup, and include the date and time. Store the backup memory card in a secure place.

## Errors

---

Memory card-related failures may occur for two reasons: the card is at fault or the Netcon circuit pack is at fault. When these failures occur, the system responds with error messages. The following is a list of the error messages in alphabetical order and recommended responses to each. Check for proper operation after each response is completed. You should also check the hardware error log for errors, and then use the maintenance manual or complete repair procedures.

1. Cannot access file storage area

The wrong memory card may be installed.

*Response:* Check to see which memory card is installed. If the correct one is installed, test it. If it passes, and the problem still persists, escalate the problem to the next level of support.

2. Cannot access file; wrong type of Memory Card is inserted

You have not inserted the correct memory card for the operation you wish to perform.

*Response:* Load the appropriate memory card.

3. Cannot access mass storage system now; try again later

Indicates the storage system is in use.

*Response:* Try again later.

4. Cannot turn on 12 volt power supply

Indicates something may be wrong with the (TN777B) Netcon circuit pack (where the power supply is).

*Response:* Test the 12-volt power supply by running the **test card-mem** command from the system administration terminal. Executing the command causes the system to run Test 701 (12 Volt Power Supply Test). If the power supply test fails, replace the (TN777B) Netcon circuit pack. To do this, follow the instructions in the Maintenance manual for MO 12v-PWR. Then, repeat whichever command failed.

5. Command has been aborted; please try later

The command has been preempted.

*Response:* Try again later.

6. Could not write to Memory Card

Indicates something may be wrong with the memory card.

*Response:* Test the memory card (run **test card-mem**).

7. File size exceeded

You have run out of file space.

*Response:* Call your Lucent Technologies representative.

2 System Basics

System backup for R6vs/si and later configurations

Page 2-22

8. Invalid directory on memory card

Indicates the memory card needs refreshing, or that something is wrong with the memory card.

*Response:* Run **test card-mem** and be sure all tests pass. Replace the memory card.

9. Memory Card is not inserted in the system

You have not inserted the memory card.

*Response:* Insert the memory card.

10. Memory Card is write-protected

Indicates the switch on the top side of the memory card is incorrectly set.

*Response:* Move the switch to the correct position with the point of a pencil or similar object. See the following figure:

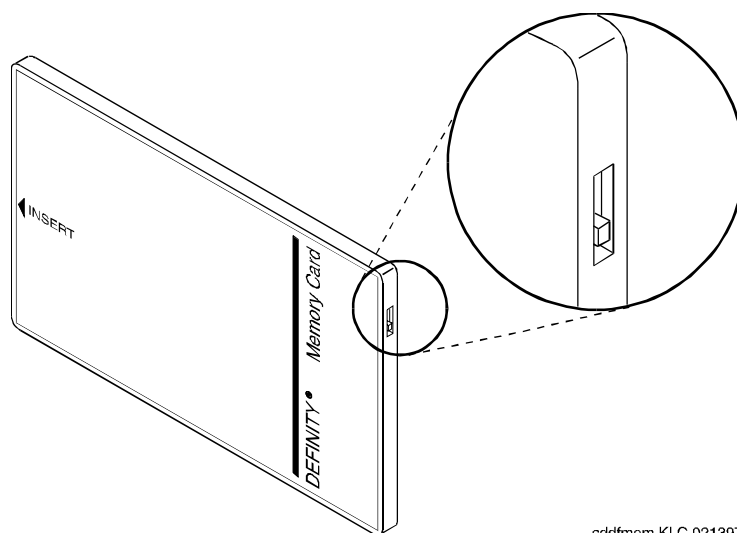

---

**Figure 2-1. Memory Card Write-Protect Switch**

11. Memory Card is unusable

Indicates something is wrong with the memory card.

*Response:* Replace the Memory Card.

12. Request is incompatible with currently running operations

Indicates the storage system is in use.

*Response:* Try again later.

2 System Basics

System backup for R6vs/si and later configurations

Page 2-23

13. Saved copy of announcements is unusable

The file on the memory card is unusable.

*Response:* Use another backup card if you have one. Instances such as this illustrate the importance of having backup cards.

14. Saved copy of translations is unusable

The copy of the translations on your memory card is faulty.

*Response:* Run the **save translations** command again.

15. Success: translation file nearly full – get larger card

This message appears in response to a “save translation” command. The translation was saved successfully but this is just a warning that the card is 95 percent full.

*Response:* Order a larger card.

16. Transmission problem; please try later

There is a problem communicating with the announcement circuit pack.

*Response:* Check to see that a data module, “Type: announcement” has been administered correctly. Use the list data-module command to determine if the data-module “Type: announcement” is administered. The data module “Type: announcement” is administered using the add data-module <extension\_number of data module type announcement>. If adding or checking the data module type announcement, verify that the “Board:” field is translated with network, carrier and slot where the announcement circuit pack is installed. Check that the Class of Restriction (COR) of the data module “Type announcement” is allowed to terminate calls from the data-modules “Type: netcon.” The data modules “Type Netcon:” with their COR can be identified by using the “list data-module” command. Note that netcon data modules must also have their COR’s translated so that they can call each other.

17. Unknown type of Memory Card

The software does not know what type of memory card is inserted in the slot. This can occur if the card is unformatted or if the current vintage of the software does not recognize that type of memory card.

*Response:* Replace the memory card with a formatted memory card the software can recognize.

18. Upgrade Memory Card inserted

You may have inserted the System Upgrade memory card instead of the 4 Mb memory card.

*Response:* Insert the 4 Mb memory card.

## System backup for R6r and later configurations

---

The primary backup operations are:

- **Save translation:** All translation data is kept in memory during system operation. This means that all data would be lost if the switch went down. The save translation operation allows the system administrator to save the in-memory translation data on disk/tape. This operation may be done as part of scheduled maintenance and/or as required.
- **Backup/Restore:** In a disk/tape configuration, additional data integrity is achievable through the disk-to-tape backup process. The backup operation can be done as part of scheduled maintenance and/or as required. The contents of the disk are copied onto a tape. This tape backup contains enough formatting/structure to allow the system to boot from it.

The **save announcement** command is only allowed if there is an integrated announcement circuit pack in the system (E28).

When MSS devices on both processors in a duplicated system are specified, the save announcements operation saves announcement data from the announcement circuit pack to the active and standby MSS devices in parallel. The status of each save operation is reported to the user separately. If one of the save operations fail, the save operation to the other device continues. The goal is to save the new announcement data on some MSS device so that it is not totally lost; this causes the announcement data to be inconsistent between these MSS devices.

In case of a failure, it is the user's responsibility to make the announcement files on the two MSS devices consistent. The files may become inconsistent due to hardware failures or if "save" to one device fails while the other continues; for example, while using the **either** option.

### Restore Announcements Command

---

The **restore announcements** command copies announcement data from the specified MSS device to the announcement circuit pack.

### Command Syntax

**restore announcements [disk | tape]**

The announcement file is always restored from the active device.

The **[disk | tape]** options specify the device from which to restore the announcement circuit pack data. This set of options only applies in a system with a disk.

## 2 System Basics

*System backup for R6r and later configurations*

Page 2-25

Invoking the **restore announcements** command with the **disk** option forces the system to copy the announcement circuit pack data from the disk to the announcement circuit pack.

Invoking the **restore announcements** command with the **tape** option forces the system to copy the announcement circuit pack data from the tape to the announcement circuit pack.

### Command Operation

There is only one announcement circuit pack allowed in the system. The announcement file is always restored from the active processor's device.

The **restore announcements** command is not allowed if there is no integrated announcement circuit pack in the system (E28); or if any port on the ANN circuit pack is active (E31).

In the case where the system crashes and/or there is a processor interchange, the restore operation fails. In this case, there is not a valid announcement file on the announcement circuit pack. The command should be restarted on the newly active processor to copy the announcements from the active processor's MSS device to the announcement circuit pack. Until the announcements are successfully and completely copied to the announcement circuit pack, calls are not connected to any announcements on the ANN circuit pack.

When the ANN circuit pack is plugged in or reset, maintenance performs a series of tests, including a DRAM Checksum test. The test fails due to the power loss to the circuit pack, resulting in automatic downloading of the announcement file.

### Error Conditions

The following is a list of all error messages displayed to the user. If any of these error conditions can be attributed to hardware failures or disk/tape configuration problems, they are logged with the maintenance subsystem. Error messages that are caused by a user entering improper command operations are not logged with the maintenance subsystem; the user is notified of the error.

For each error message listed, an identifier is provided that indicates where on the screen the message occurs. If (M) is shown next to the error code, the error message appears on the message line. If (W) is shown next to the error code, the error message appears as command output.

A failure can occur on either processor in a duplicated system. When the error is displayed, it is associated with the processor on which the error was encountered.

**2 System Basics**

*System backup for R6r and later configurations*

|         |  |
|---------|--|
| E3 (M)  | <p>MSS is currently in use</p> <p>Some other administration or maintenance user is currently making use of the MSS device and, therefore, it is not available for the MSS operation requested.</p>   |
| E11 (M) | <p>Standby option invalid on a simplex system</p> <p>A duplex option to a command was specified on a simplex system.</p>   |
| E12 (M) | <p>The disk option is invalid in a tape-only system</p> <p>A disk option was entered on an MSS command for a tape-only system.</p>   |
| E13 (W) | <p>Disk device is out of service</p> <p>The disk device has been taken out of service by maintenance.</p>  |
| E14 (W) | <p>Tape device is out of service</p> <p>The tape device has been taken out of service by maintenance.</p>  |
| E16 (W) | <p>Standby processor (PE_A) is not available or</p> <p>Standby processor (PE_B) is not available</p> <p>The standby processor has been taken out of service by maintenance, that the PE-SELECT switches are not in their normal position, or that some other hardware problem exists. When the standby processor is out of service, memory shadowing from the active processor to the standby processor is disabled.</p> |
| E28 (W) | <p>Integrated announcement board not present</p> <p>The announcement circuit pack is not present in the system.</p>  |
| E29 (W) | <p>Required data module not administered or unavailable</p> <p>The required data module is either not administered or is currently in use.</p>   |
| E31 (W) | <p>Announcement port in use; please try later</p> <p>One or more of the announcement ports are in use for an integrated announcements session or for integrated announcement playback.</p>   |
| E32 (W) | <p>Bad announcement file on tape (disk)</p> <p>The announcement file stored on disk or tape is corrupt. A valid file must be stored on the MSS before it can be accessed. This helps to prevent overwriting valid announcements on the ANN circuit pack.</p>   |

*Continued on next page*



2 System Basics

System backup for R6r and later configurations

|         |  |
|---------|--|
| E33 (W) | No announcements on board<br>Announcements must be stored on the ANN circuit pack in order to proceed with command. This helps to prevent overwriting or corrupting a good announcement file on the MSS.                                 |
| E34 (W) | Announcement data module out of service<br>The announcement data module has been taken out of service by maintenance. The data module could have been taken out of service because of errors on the data module detected by maintenance. |
| E35 (W) | Required system access port not administered or out of service<br>A system access port is either not available or is out of service.   |
| E36 (W) | Announcement data module not available<br>Cannot access the announcement data module because the upload/ download port is active.  |
| E37 (W) | Tape access failure; no tape cartridge or tape drive failure<br>No tape is in the tape drive.  |
| E38 (W) | Tape write failure; no tape cartridge or tape drive failure<br>The tape is write protected.  |
| E39 (W) | Required system access port unavailable<br>The required system access port is unavailable.   |
| E40 (W) | Tape (disk) not formatted with announcement file<br>Device must be formatted with the announcement file in order to read or write it.  |
| E41 (W) | Refresh currently in progress, please try again later<br>MSS is in use by <b>SPE</b> duplication memory refresh. This is an indication to try the command again later.   |
| E42 (W) | MSS device is maintenance busy   |

## Save Translation command

The **save translation** command copies translation data from memory to the MSS. By default, translation data is written to the primary MSS device in a simplex processor system, or to both primary MSS devices in a duplicated processor system. In addition, the **save translation** command can be directed to write to devices on either of the processors and/or the secondary device(s). The translation data can be automatically backed up as part of regularly scheduled maintenance. It is recommended that automatic backup be performed on a daily basis.

### Command syntax

The bracketed options specify to which mass storage system the translation data is to be saved. This set of options only applies in a duplicated system. The options, **SPE\_A** and **SPE\_B**, see processors **A** and **B** respectively in a duplicated system.

Invoking the command with the **active** option instructs the system to write to the specified device in the active processor.

Invoking the command with the **standby** option instructs the system to write to the specified device in the standby processor.

Invoking the command with the **either** option causes the system to write the translation data to the specified device on both processors. If the standby processor is inaccessible, the command still executes on the active processor and data is copied to the specified device.

Invoking the **save translation** command with the **SPE\_A** option forces the system to write the translation data to the specified device in processor A. **SPE\_A** is the default in a simplex system.

Invoking the **save translation** command with the **SPE\_B** option forces the system to write the translation data to the specified device in processor B.

In duplicated systems, **both** is the default option.

The **[disk | tape]** option specifies the device on which to save the translation data. This option set only applies in a system with a disk.

Invoking the **save translation** command with the **disk** option forces the system to write the translation data to the disk. In a system configured with both a disk and a tape, **disk** is the default.

Invoking the **save translation** command with the **tape** option forces the system to write the translation data to the tape. In a system configured with only a tape unit, **tape** is the default.

In a duplex system, the capability to save translation to only one of the MSS devices is provided. This capability should be exercised with extreme caution since it is likely to lead to translation data inconsistencies between the different devices on the two processors.

## Command operation

The **save translation** command writes two time-stamped identical copies of translation data to the selected devices. The time stamp for both copies are the same (the time of writing to the first copy). Each copy also contains the state of the copy (either “good” or “bad”).

The save operation writes one complete copy first, then writes the second copy in a different area of the device. The save operation updates only one copy at a time. The save operation always overwrites the “least good” copy first. The following selection criteria should be applied on both the active and standby devices:

- If a copy has a bad status, always overwrite that copy first.
- If both copies have good status, overwrite the one with the older time stamp. If both time stamps are the same, it does not matter which copy is overwritten first since the copies are identical.

Each copy of the translation data is marked “bad” prior to a translation save operation, and it is only marked “good” after the save operation to that file completes successfully. Any failure during the save operation, including a system crash, usually affects only one copy of translation data. If this occurs, the affected copy is marked with a “bad” status indicator and should not be used to load translation into the system. Thus an intact copy of translation can be used as a backup. Normally at least one of the two copies is in a good state. If **save translation** is performed automatically as part of daily scheduled maintenance, there is a high degree of probability that identical copies of translation exist on the tape.

When MSS devices on both processors in a duplicated system are specified, the save operation saves translation data from the active processor to the active and standby MSS devices in parallel. The status of each save operation is reported to the user separately. If one of the save operations fail, the save operation to the other device continues.

If invoked during regularly scheduled maintenance, the **save translation** command in a duplicated processor system saves the translation to one of the MSS devices even if the other device is out of service.

The command completion status is displayed on [Screen 2-9](#).

2 System Basics

System backup for R6r and later configurations

```

Save Translation
Processor      Command Completion Status      Error Code
SPE_A*        success/specific error message  n1
SPE_B*        success/specific error message  n2
    
```

Screen 2-9. Command Completion Status

- In a simplex system, only the active (default) SPE status is given. In a duplex system, if a qualifier is used to select save translation for only one SPE, only that SPE's status is given.

The displayed information includes either a success message or an error message and error code for each processor (see [Table 2-2](#)). A success message means both copies of translation data were updated successfully on a particular device from the in-memory translation data. The error code for each processor provides further information as to whether only one or two copies of translation data were updated successfully. If only one copy was updated or neither copy was updated, an alarm would be raised on that device so that the system technician can take appropriate repair actions.

Table 2-2. Save Translation Command Error Codes

| CODE | Interpretation  |
|------|---|
| 0    | The save operation was a complete success; both copies of translation data were updated.              |
| 1    | The save operation was a partial success; only one of the two copies of translation data was updated. |
| 2    | The save operation failed completely; no translation was saved to either copy of translation data.    |

The following operational rules apply to the **save translation** command:

1. The **save translation** command is only allowed if there are no translation updates being made. All requests to update translation after the command starts are denied (E1).  
 If Terminal Translation Initialization (TTI) activation or deactivation is in progress, the **save translation** command is denied (E2).
2. The **save translation** command is not allowed if the MSS is engaged by another user or is being used for background maintenance (E3).

## 2 System Basics

System backup for R6r and later configurations

Page 2-31

3. The options entered by the user are validated against the system configuration and the target devices for the **save translation** command are determined (E11, E12).
4. If the user requests that translation be saved to a disk, the disk must be in service (E13). If the user requests that translation be saved to a tape, the tape must be in service (E14). If the user requests that translation be saved to the standby processor, the standby processor must be in service, shadowing must be enabled, refresh must be completed, and handshake must be up (E16).
5. If the file system of the target device is a core-dump file system, the command is denied (E17).

If the target device is a tape, and the file system type of the tape is an installation file system, and the vintage of the boot image running in the active processor matches the vintage of the boot image on the tape, then the system first configures the tape with the same configuration as is currently running. If the in-memory vintage does not match the vintage on the tape, the save translation command is denied (E18). In this situation, the user must manually configure the tape by using the **configure** command and then reissue the **save translation** command.

6. If errors are encountered in the operations described above, the save operation should not be attempted.

## Backup command

Additional data integrity is achievable through disk to tape backups. These backups may be done on demand or run daily as part of scheduled maintenance. The **backup** command works in either a simplex SPE or a duplex SPE system. When the command is run as part of scheduled maintenance, the default for a simplex system is an **incremental** backup of SPE A. In a duplex system, the default is an **incremental** backup on **both** SPE A and SPE B.

When the **backup** command is executed on demand the defaults remain the same.

## Command syntax

**backup disk [active | standby | SPE\_A | SPE\_B | both | either] [incremental | full]**

The bracketed options, **[active | standby | SPE\_A | SPE\_B | both | either]**, specify which mass storage system the user wishes to backup. Invoking the **backup** command with the **SPE\_A** option causes files from the disk associated with processor **A** to be copied to the tape cartridge on the same processor. **SPE\_A** is the default in a simplex system. Invoking the **backup** command with the **SPE\_B** option causes the files on the disk on processor **B** to be copied to the tape on the same processor.

## 2 System Basics

*System backup for R6r and later configurations*

Page 2-32

Invoking the command with the **active** option causes the files on the disk on the active processor to be copied to the tape on that processor.

Invoking the command with the **standby** option causes the files on the disk on the standby processor to be copied to the tape on that processor.

Invoking the **backup** command with the **both** option causes files on the disks associated with both of the processors to be backed up to their respective tapes concurrently. If the standby processor is inaccessible the command fails on both processors. No files are copied from disk to tape on either processor. The default value in a duplex system is **both**.

Invoking the **backup disk** command with the **either** option causes the files on the disks associated with both of the processors to be backed up to their respective tapes concurrently. If the standby processor is inaccessible, the command still executes on the active processor and the disk files is copied to tape.

Invoking the command with the **incremental** option causes a selective backup to be performed. In this case, all files on the disk that are marked as “good files” and which have a newer last file update time than the corresponding tape files, are copied to the tape. Not copying files marked as “bad” ensures that corrupted files do not overwrite good (but possibly older) files. The default value is **incremental**.

If a **full** disk backup is specified, the entire disk is copied to tape. All files, “good” and “bad,” regardless of the last file update times, are copied to the tape.

### Command operation

When an **incremental** backup is performed, the following procedure governs this operation. Before each file is copied from the disk to the tape, the file on the tape is marked as “bad.” When the file has been completely copied over to the tape, the file is then marked as “good” on the tape. This process ensures that if the system were to reboot in the middle of this operation, files in the process of being copied are not usable (on the tape) because they are still marked as “bad.”

When a **full** backup is performed, the following procedures are used. When the process begins, all files on the tape are marked as “bad.” When the entire disk has been copied, the files on the tape are marked as “good.” The only exception to this is that a file which is marked as “bad” on the disk retains this marking on the tape also.

When the backup is performed on **both** processors, the operation is performed in parallel. If the backup operation fails on one processor the backup operation proceeds on the other processor.

The success or failure of the backup operation for each processor is displayed on the screen, as shown on [Screen 2-10](#).

```
Processor      Backup Disk
              Command Completion Status
SPE_A*        success/specific error message
SPE_B*        success/specific error message
```

## Screen 2-10. Backup Completion Station

\* In a simplex system, only the active (default) SPE status is given. In a duplex system, if a qualifier is used to select backup disk for only one SPE, only that SPE's status is given.

The following operational rules apply to the **backup** command:

1. The **backup** command is only allowed if there are no other applications currently using the MSS devices (E3).
2. The options entered by the user are validated against the system configuration and the target devices for the backup command are determined (E11).
3. The disk must be in service (E13). The tape must be in service (E14).
4. If the user requests that the **backup** take place on the standby processor, the standby processor must be in service, shadowing enabled, and refresh completed (E16). If the file system of the tape is a core-dump file system, the command is denied (E17).

For incremental backup, if the file system type of the tape is an installation file system, and the vintage of the boot image running in the active processor matches the vintage of the boot image on the tape, then the system first configures the tape with the same configuration as is currently running. If the in-memory vintage does not match the vintage on the tape, the **backup** command is denied (E18). The tape must be manually configured in this situation.

If the **incremental** option is specified and the file systems of the disk and tape are not the same, the command is denied (E23).

5. For full backup, if the tape has installation, large, or core-dump file system, backup proceeds.
6. If errors are encountered in the operations described above, the backup operation should not be attempted.

## Restore command

---

The **restore** command allows the user to copy files from a tape (which was used to backup the disk) to the disk. This operation is used for system installation, system upgrades/updates, or after a repair of the disk has occurred.

### Command syntax

**restore disk [active | standby | SPE\_A | SPE\_B | both | either] [incremental | full]**

The options, **[active | standby | SPE\_A | SPE\_B | either | both]**, specify which mass storage system the user wishes to restore.

Invoking the **restore** command with the **SPE\_A** option causes files from the tape associated with processor **A** to be copied to the disk on that same processor. **SPE\_A** is the default in a simplex system.

Invoking the **restore** command with the **SPE\_B** option causes files from the tape associated with processor **B** to be copied to the disk on that same processor.

Invoking the **restore** command with the **active** option causes the files on the tape on the active processor to be copied to the disk on the same processor.

Invoking the **restore** command with the **standby** option causes files from the tape associated with the standby processor to be copied to the disk on that same processor.

Invoking the **restore** command with the **both** option forces the system to copy files from the tape-to-disk device on both mass storage systems concurrently. If the standby processor is inaccessible, the command fails on both processors. This means that no data is written on either of the specified processors. The default in a duplex system is **both**.

Invoking the **restore** command with the **either** option forces the system to copy files from tape to disk device in both mass storage systems concurrently. If the standby processor is inaccessible, the command still executes on the active processor and files are copied to the disk.

Invoking the command with the **incremental** option causes a selective restore operation to be performed. In this case, all files on the tape that are marked as "good" and which have a newer last file update time than the corresponding disk files, are copied to the disk. Not copying files marked as "bad" ensures that corrupted files do not overwrite good (but possibly older) files. The default value is **full**.

If a **full** disk restore is specified, the entire contents of the tape are copied to the disk. All files, "good" and "bad," regardless of the last file update times, are copied to the disk.



## Command operation

For an **incremental** restore, the files are copied in the following manner. Before each file is copied from the tape to the disk, the file on the disk is marked as “bad.” When the file from the tape has been completely copied over onto the disk, the file is then marked as “good” on the disk. This process ensures that if the system were to reboot in the middle of the operation, files in the process of being copied are not usable because they are still marked as “bad.”

For a **full** restore operation, the files are copied in the following manner. When the process begins, all files on the disk are marked as “bad.” When the entire tape has been copied to disk, the files on the disk are marked as “good.” The only exception to this is that a file which is marked as “bad” on the tape retains this marking on the disk also.

The success or failure of the command for each processor is displayed on the screen, as shown in [Screen 2-11](#).

```
Processor      Restore Disk
              Command Completion Status
SPE_A*        success/specific error message
SPE_B*        success/specific error message
```

### Screen 2-11. Restore Completion Status

The following operational rules apply to the **restore** command:

1. The **restore** command is only allowed to run if there are no other applications currently using the MSS devices (E3).
2. The options entered by the user are validated against the system configuration, and the target devices for the restore command are determined (E11).
3. The disk must be in service (E13). The tape must be in service (E14).
4. If the user requests that the restore take place on the standby processor, the standby processor must be in service, shadowing enabled, and refresh completed (E16).
5. If the file system of the tape is a core-dump file system, the command is denied (E17).

If the file system of the tape is an installation file system, the command is denied (E22). If the **incremental** option is specified and the file systems of the disk and tape are not the same, the command is denied (E23).

6. If errors are encountered in the operations described above, the restore operation should not be attempted.

## Error conditions

The following is a list of all error messages displayed to the user. If any of these error conditions can be attributed to hardware failures or disk/tape configuration problems, they are logged with the maintenance subsystem. Error messages that are caused by a user entering improper command options are not logged with the maintenance subsystem; the user is notified of the error.

For each error message listed, an identifier is provided that indicates where on the screen the message occurs.

A failure can occur on either processor in a duplicated system. When the error displays, it is associated with the processor on which the error was encountered.

|        |   |
|--------|---|
| E1     | login:cha station 51001 has data locked<br><br>This error message is displayed for the <b>save translation</b> command when there is an active <b>translation update</b> command.   |
| E2 (M) | TTI activation or deactivation is in progress;<br>this command is not allowed at this time<br><br>When TTI activation or deactivation is in progress, <b>save translation</b> cannot occur. The TTI activation or deactivation must be suspended first. |
| E3 (M) | 'loginid': "command" has cmd conflict<br><br>The user logged in with 'loginid' has a command that conflicts with the MSS command you are using.   |
| E4 (W) | No tape in tape drive<br><br>The tape cartridge is missing from the drive.  |
| E5 (W) | Tape write failure: tape cartridge or device failure<br><br>There is a failure in writing to the tape. This may be caused because the tape cartridge is missing from the tape drive, or by non-operational tape hardware.                               |
| E6 (W) | Tape read failure: tape cartridge or device failure<br><br>There is a failure in reading from the tape. This may be caused because the tape cartridge is missing from the tape drive, or by non-operational tape hardware.                              |
| E7 (M) | System error; Reboot<br><br>There was a severe system error while processing this request. This might require system reboot or system technician intervention to resolve.   |

*Continued on next page*

2 System Basics

System backup for R6r and later configurations

|         |   |
|---------|---|
| E9 (W)  | Disk write failure: device failure<br>There is a hardware problem with the drive itself.  |
| E10 (W) | Disk read failure: device failure<br>There was a failure in reading from the disk. This may be caused by a media error or by non-operational disk hardware.   |
| E12 (M) | The disk option is invalid in a tape-only system<br>The disk option was entered on an MSS command for a tape-only system.   |
| E13 (W) | Disk device is out of service<br>The disk device has been taken out of service by maintenance.  |
| E14 (W) | Tape device is out of service<br>The tape device has been taken out of service by maintenance.  |
| E16 (M) | Standby processor (SPE_A) is not available" or<br>Standby processor (SPE_B) is not available<br>The standby processor has been taken out of service by maintenance, that the SPE-SELECT switches are not in their normal position, or that some other hardware problem exists. When the standby processor is out of service, memory shadowing from the active processor to the standby processor is disabled. |
| E17 (W) | Tape contains a coredump file system<br>The wrong type of tape is in the tape drive.  |
| E18 (W) | Tape vintage does not match in-memory vintage;<br>must configure tape first<br>By ensuring that the tape vintage matches the in-memory vintage, the system technician is made aware of a possible operational error.  |
| E19 (W) | Large system boot image is corrupt on the tape<br>The large system boot image has been overwritten by a core dump. The tape cannot be converted to a large system tape.   |
| E22 (W) | Tape file contains an installation file system<br>The wrong type of tape is in the tape drive.  |
| E23 (W) | Disk and tape are configured with different file systems<br>The disk and tape are configured with different file systems and the user issued <b>backup</b> or <b>restore</b> commands with the <b>incremental</b> options.  |

*Continued on next page*

**2 System Basics**

*System backup for R6r and later configurations*

*Page 2-38*

|         |   |
|---------|---|
| E27 (W) | Device access failure: device directory corruption<br>The directory files on a device are corrupt.  |
| E28 (W) | Small file system already exists<br>The user is trying to configure a small file system to a tape that already contains a small file system. This operation is not allowed. |
| E29 (W) | Large file system already exists<br>The user is trying to configure a large file system to a tape that already contains a large file system. This operation is not allowed. |

## System Security

# 3

---

### Overview

---

Toll fraud is the theft of long distance service, and can come from both internal and external sources. When toll fraud occurs, your company is responsible for usage charges. In addition, unauthorized use may tie up your system, preventing your customers from reaching you and your employees from doing business.

Lucent Technologies has designed the DEFINITY ECS to help you to limit toll fraud. However, there are steps that you as the administrator must also take to keep your system secure from unauthorized use.

### Learn about the problem

---

The *BCS Products Security Handbook* contains a wealth of information about toll fraud and what you can do to prevent it. It discusses the methods people use to gain access to your system, how to detect toll fraud, and what to do if you suspect that your system has been compromised.

The *BCS Products Security Handbook* contains security information for many Lucent Technologies products, so you can ensure that all of your telecommunications equipment is secure. It also contains security checklists for each of these products. You should go through these with your Lucent Representative for each piece of equipment you use.

### Where to get help

---

For assistance with toll fraud prevention, call the Lucent Technologies National Customer Care Center Support Line at 1-800-643-2353.

If you have identified fraudulent calling in progress, and require assistance in stopping the fraud, call the Lucent Technologies Technical Service Center at 1-800-242-2121 and select the option for toll fraud help.

## Basic security

---

The following is a partial list that you can use to help secure your system. It is not intended as a comprehensive security checklist. The *BCS Products Security Handbook* provides more detail about these and other security-related features.

- When administering logins, enable logoff notification and forced password aging. You must assign passwords for these logins at setup time.
- Administer Security Violation Notification to report unsuccessful attempts to access the system. Security Violation Notification allows you to automatically disable a valid login ID following a security violation involving that login ID and disable remote access following a security violation involving a barrier code or authorization code.
- Use the **list history** command to determine if unauthorized changes have been made to the system. To assist in identifying unauthorized use of the system, the History report lists each time a user logs in or off the system. See *DEFINITY ECS System Monitoring and Reporting* for a detailed discussion of this report.
- Ensure that the Remote Administration port is secure. If it is not secure, an unauthorized user can compromise the system in many ways, such as viewing Barrier and Authorization codes or viewing Feature Access Codes. You can restrict this port to certain login IDs using the Login Administration form. The optional Remote Port Security Device (RPSD) is a password encryption device that can be attached to the Remote Administration Port for increased security.
- If you suspect that unauthorized access has occurred, change the barrier codes, authorization codes, passwords, and any other sensitive codes.
- Secure trunks using Automatic Route Selection, Class of Restriction, Facility Restriction Levels and Alternate FRLs, Authorization Codes, Automatic Circuit Assurance and Forced Entry of Account Codes (see CDR).
- Monitor your system on a regular basis so that you will notice unusual traffic patterns if they occur. Call Detail Recording, Security Violation Notification and a number of reports allow you to do this.
- Activate Enhanced Call Transfer for your voice messaging system, if available. This limits transfers to valid extensions, but you also need to restrict transfers to extensions that may offer dial tone to the caller, such as remote access extensions.

## Physical security

- Keep wiring closets and switch rooms secure.
- Keep any documentation pertaining to switch operation secure.
- Keep any reports that may reveal trunk access code, remote access barrier codes, authorization codes, or password information secure.

## Features requiring security precautions

Follow the guidelines in the *BCS Products Security Handbook* when administering the following features:

- Automated Attendant
- AUDIX Interface
- Call Coverage
- Call Forwarding
- Call Vectoring
- Extended User Administration of Redirected Calls
- Facility Test Calls
- PC Interface
- Personal Station Access
- Remote Access
- Remote Administration
- Service Observing
- Terminal Translation Initialization
- Transfer — Trunk-to-Trunk
- Trunk-to-Trunk Transfer Restriction Override
- Trunk Flash
- Voice Response Integration

Consult the *BCS Products Security Handbook*, for additional steps to secure your system and to find out how to regularly obtain information concerning security developments.





## Basic Features

# 4

---

### Abbreviated Dialing

---

Abbreviated Dialing (AD) provides lists of stored numbers for:

- Placing local, long-distance, and international calls
- Activating features
- Accessing remote computer equipment

Voice-terminal and data-terminal users can access stored numbers from all types of lists: group-number, system-number, enhanced-number, and personal-number via AD numbers. Attendants can access stored numbers from group-number, system-number, and enhanced-number lists via AD numbers. AD numbers can have up to 24 digits. Users can access designated numbers not stored on AD lists via automatic-dialing buttons. Automatic-dialing buttons can have up to 16 digits.

Each stored number is one list entry. Users choose an appropriate list by dialing an access code followed by its 1-, 2-, 3-, or 4-digit list entry number. The number is then dialed automatically by the system. Users may reach a frequently-called number with a single button press by storing the dialing sequence on an AD button.

**How to administer AD**

---

**Required forms**

---

| <b>Form</b>               | <b>Field</b>  | <b>Page</b>           |
|---------------------------|---|-----------------------|
| AD 7103A                  | ■ All   | <a href="#">5-14</a>  |
| AD Enhanced List          | ■ All   | <a href="#">5-2</a>   |
| AD Group List             | ■ All   | <a href="#">5-5</a>   |
| AD Personal List          | ■ All   | <a href="#">5-8</a>   |
| AD System List            | ■ All   | <a href="#">5-11</a>  |
| Attendant Console         | <ul style="list-style-type: none"> <li>■ Feature Button Assignments</li> <li>■ AD buttons</li> <li>■ AD Program Buttons</li> <li>■ AD Special Character Buttons</li> </ul>  | <a href="#">5-35</a>  |
| Console-Parameters        | <ul style="list-style-type: none"> <li>■ AD List 1</li> <li>■ AD List 2</li> <li>■ AD List 3</li> </ul>   | <a href="#">5-86</a>  |
| Data Line Data Module     | ■ List1   | <a href="#">6-234</a> |
| Feature Access Code (FAC) | <ul style="list-style-type: none"> <li>■ AD List 1 Access Code</li> <li>■ AD List 2 Access Code</li> <li>■ AD List 3 Access Code</li> <li>■ AD Program Group List Access Code</li> <li>■ Program Access Code</li> </ul> | <a href="#">5-113</a> |

---

*Continued on next page*

**Required forms — Continued**

| Form                              | Field  | Page                  |
|-----------------------------------|--|-----------------------|
| Feature-Related System Parameters | ■ Off-Premises Tone Detect Time-out Interval | <a href="#">5-123</a> |
|                                   | ■ AD Programming by Assigned List            |                       |
| Station (multiappearance)         | ■ AD List 1                                  | <a href="#">6-14</a>  |
|                                   | ■ AD List 2                                  |                       |
|                                   | ■ AD List 3                                  |                       |
|                                   | ■ Feature Button Assignments                 |                       |
|                                   | ■ AD Buttons                                 |                       |
|                                   | ■ Autodial Buttons                           |                       |
|                                   | ■ AD Program Buttons                         |                       |
|                                   | ■ AD Special Character Buttons               |                       |
|                                   | ■ Hot Line Destination (if applicable)       |                       |
|                                   | ■ AD List Number                             |                       |
|                                   | ■ Dial Code                                  |                       |

**Detailed description**

**List types**

Numbers are stored in four types of lists: personal-number, group-number, system-number, and enhanced-number. Switch type and version determine available lists and maximum entries per list.

■ Personal-number lists

Personal-number lists are used by voice-terminal and data-terminal users who need a set of stored personal numbers. An individual user can have up to three personal-number lists. You, or the user, program the personal-number lists. You determine which users are allowed to have a personal list and the size of each list. Personal-number lists are created automatically when the capability of accessing a personal list is administered for the individual station.

■ Group-number lists

Group-number lists are used by members of groups such as purchasing and personnel departments, who have the need to frequently dial the same numbers. Voice-terminal users, data-terminal users, and attendants

can access up to three specific group-number lists. You administer the lists. You can choose a designated user in each group to program the list. Specify this user on the Abbreviated Dialing Group List form.

- System-number lists

System-number lists are used by voice-terminal users, data-terminal users, and attendants who need to frequently dial the same numbers as a member of a group (such as members of purchasing or personnel departments). You administer the system-number lists.

- Enhanced-number lists

Enhanced-number lists are used by voice-terminal users, data-terminal users, and attendants who need more list entries than those allowed in group-number and system-number lists. One enhanced-number list is allowed per system in addition to the system-number list. The enhanced-number list can contain any number or dial-access code. You administer the enhanced-number lists and determine which users can access the list.

 **NOTE:**

You can designate all group-number lists, system-number lists, and enhanced-number lists as “privileged.” Calls automatically dialed from a privileged list are completed without class of restriction (COR) or facility restriction level (FRL) checking. This allows access to selected numbers that some voice-terminal users might otherwise be restricted from manually dialing. For example, a voice-terminal user may be restricted from making long-distance calls. However, the number of another office location may be long distance. This number could be entered in a list designated as privileged. The user could then call the office location using AD, while still being restricted from making other long-distance calls.

## List entries

The following describes the numbering schemes used to select a list entry once an AD list is accessed.

### Personal-number list entries

For personal-number lists administered for five or ten entries, the user dials a single digit to access a list entry number. Entries are numbered 1 through 9, and 0 (list entry 10). For example, to access entry 6 the user dials 6, to access entry 10 the user dials 0.

For personal-number lists administered for more than ten entries, the user dials a 2-digit number to access a list entry. For example, to access entry 6 the user dials 06, to access entry 100 the user dials 00.

### Group-number and system-number list entries

AD provides the option of selecting between two group-number and system-number list entry numbering schemes. The type of numbering scheme used is administered on the System-Parameters Customer-Options form.

**Table 4-1. Group-Number and System-number List Entry Numbering Schemes**

| List Entry Number | User Dials (Scheme 1) | User Dials (Scheme 2) |
|-------------------|-----------------------|-----------------------|
| 1                 | 11                    | 01                    |
| 2                 | 12                    | 02                    |
| .                 | ..                    | ..                    |
| .                 | ..                    | ..                    |
| .                 | ..                    | ..                    |
| 10                | 20                    | 10                    |
| 11                | 21                    | 11                    |
| ..                | ..                    | ..                    |
| 89                | 99                    | 89                    |
| 90                | 00                    | 90                    |
| 91                | 01                    | 91                    |
| ..                | ..                    | ..                    |
| ..                | ..                    | ..                    |
| 100               | 10                    | 00                    |

### Enhanced-number lists

The number of digits in enhanced-number list entry numbers can be either three or four digits, as administered on the System-Parameters Feature form.

### Special characters

Digits stored in AD lists include numerical digits and special characters that instruct the system to take specified actions. Special characters count as two digits toward the 24-maximum-allowable digit limit. You and multiappearance voice-terminal users program special characters. Available characters are shown in the following table.

**Table 4-2. Special characters**

| Special Character    | Description   | Function   |
|----------------------|---|--|
| Indefinite Wait (~W) | This means that an indefinite wait follows the indefinite wait character until dial tone is detected.   | <ul style="list-style-type: none"> <li>■ Useful when frequent dial-tone delays of longer than one minute occur</li> </ul>  |
| Mark (~m)            | This means end-to-end signaling digits.   | <ul style="list-style-type: none"> <li>■ Useful when doing touch-tone signaling over dial-pulse trunks</li> <li>■ Place mark characters prior to digits to be outpulsed with touch-tone signaling</li> </ul>   |
| Pause (~p)           | This means that 1.5-second delays follow pause characters when digits are being outpulsed over a trunk. The interval is administrable.                    | <ul style="list-style-type: none"> <li>■ Useful when far-end dial tones from another switch returns within 1.5 seconds</li> <li>■ Used with tandem switching through private networks or end-to-end signaling</li> <li>■ May cause aborted calls if used as the first digit</li> </ul> |
| Suppress (~s)        | This means that digits following suppress characters are not displayed through the voice-terminal display feature. A lowercase s displays for each digit. | <ul style="list-style-type: none"> <li>■ Useful when the user does not want part of a dialed number to be displayed.</li> <li>■ Affects the display of stored-number digits. Digits following suppress characters appear as a lowercase s.</li> </ul>                                  |

*Continued on next page*

**Table 4-2. Special characters — Continued**

| Special Character | Description  | Function   |
|-------------------|--|--|
| Wait (~w)         | This means that a 5- to 25-second delay (or a delay until dial-tone is detected) follows wait characters when digits are being outpulsed over a trunk. The delay is administrable. | <ul style="list-style-type: none"> <li data-bbox="790 333 1145 485">■ Useful when frequent, variable-length dial tone delays or network blocking outside the system is experienced</li> <li data-bbox="790 507 1126 628">■ Used with tandem switching through private networks or end-to-end signaling</li> <li data-bbox="790 650 1145 704">■ May cause aborted calls if used with the first digit</li> </ul> |

### AD access options

AD numbers can be accessed by any of the following options:

- AD codes

Users can access a stored number by dialing the AD feature-access code (FAC) and a list entry number. Each AD code automatically dials the number stored in the list the user accessed.
- AD buttons

Multiappearance voice-terminal users and attendants can access stored numbers by pressing one or more buttons. Each AD button automatically dials the number stored in the list and the list entry number administered to the button.

Access to any list and associated list entry number can be programmed on an AD button on a multiappearance voice terminal. An AD button on an attendant console can be programmed to access a group, system, or enhanced list and associated list entry numbers.

You administer the AD button. If the button is administered to access a number in the user's personal-number list, the user can change the number assigned to the button. If the number assigned to the button accesses an entry on a group list, you or a designated user can make the change. If the number assigned to the button accesses an entry on the system list or the enhanced list, only you can make the change.

- Automatic-dialing buttons

Users can directly dial numbers by pressing one or more buttons. Each automatic-dialing button is administered to automatically dial a number that is not stored on any of the AD lists. The number can have up to 16 characters. You or the user program the automatic-dialing buttons. Autodialing is not affected by AD lists.

- 7103A group-number lists

A separate list, the 7103A group-number list, is used only by 7103A Fixed Feature voice-terminal users as a group. This list allows button access to stored numbers and can have eight list entries. Any number can be stored in the 7103A group-number list; however, it is intended primarily for FACs. You program the 7103A group-number lists.

- Programming

Users can program their personal-number lists, any AD buttons that access a number from their personal-number list, and their automatic-dialing buttons. Only designated users can program an AD button that accesses a number from a group-number list. Programming is done by dial access or by pressing the program button, if assigned.

## End-user operations

### Programming personal lists, AD buttons, and automatic-dialing buttons

- To program an entry in a personal-number list, the user:
  1. Dials the program-access code or presses the program button
  2. Dials the personal-list number, the dial-code number, and the number to be stored (up to 24 digits)
  3. Presses either # or the AD button

Confirmation tone is heard when the number is stored. While in the program mode, users can program all personal-number list entries. To exit the program mode, the user hangs up.

- To program an AD button administered to access a particular entry in the personal-number list, the user:
  1. Dials the program-access code or presses the program button, if assigned
  2. Presses the AD button, dials the number (up to 24-digits)
  3. Presses #

Confirmation tone is heard when the number is stored. In the program mode, the user can program as an unlimited amount of AD buttons (including automatic-dialing buttons). To exit the program mode, the user hangs up.



## Programming group lists

Voice-terminal users can program the group lists to which they are assigned as the designated user. For example, a department secretary may be the designated user for a group list created for the department. Designated users are assigned per group list on the Abbreviated Dialing Group List form. Users who attempt to program group lists for which they are not the designated user receive intercept tone.

The method a designated user uses to program a group list depends on the access codes and buttons administered for the terminal and system. The designated user can program the group list using the:

- Program-access code or AD program button in conjunction with an AD button. In this case, the number to be programmed must be associated with that AD button.
- Program-access code or AD program button when an AD button is not available. In this case, the user can only program lists assigned (as list 1, 2, or 3) to the terminal he or she is using. Other lists for which the user is the designated user cannot be programmed in this way.

Group lists can only be programmed in this way if the *Abbr Dial Programming By Assigned List* field is set to **y** on the *Feature-Related System-Parameters* form.

- AD group list program FAC. When the AD group list program FAC is used to program a group list, the user can program any list for which they are specified as the designated user.

The following instructions describe how designated users program group lists from their voice terminals. You can program group lists on the switch.

- Programming the group list with the AD program-access code or AD program button with an AD button

An AD button can be used by the designated user to program the group list number associated with that button. The user:

1. Dials the AD program-access code or presses the AD program button
2. Presses the AD button, dials the number
3. Presses #

Confirmation tone is heard when the number is stored.

- Programming the group list with the AD program-access code or AD program button (no AD button)

The user:

1. Dials the AD program-access code or presses the AD program button
2. Dials 1, 2, or 3 to select a group list (administered on their station form) followed by the 2-digit list entry number of the entry to be programmed
3. Dials the number
4. Presses #

Confirmation tone is heard when the number is stored.

- Programming the group list with the AD group list program FAC

The user:

1. Dials the AD group list program FAC
2. Dials the 3- or 4-digit group list number to select a group list followed by the 2-digit list entry number of the entry to be programmed
3. Dials the number
4. Presses #

Confirmation tone is heard when the number is stored.

### Programming AD labels on 6400 and 8400 display sets

Users of the 8400- and 6400-series display phones can customize the display labels for Abbreviated Dialing buttons. Messages appear on the display to guide users through the programming of AD numbers and softkey labels. For this feature to work, the speaker must be activated on the phone, and the switch software must be R6.3 or higher.

To program a softkey button, the user:

1. Presses the button labeled Prog, or selects Prog from the softkey menu  

The message `Press button to program` appears on the display.
2. Selects the softkey/feature button to program
3. The message `Change number? Yes=1 No=2` appears.
4. Presses **1** to enter a new number or change an existing one, or **2** to skip this step and move on to programming the label
5. Enters the number for this AD button
6. Presses # to save the number

Confirmation tone is heard when the number is stored. The message `Change label? Yes=1 No=2` appears.

7. Presses **1** to change the label, or **2** to skip this step.

The message `Enter label` appears.

8. Enters the label (up to five characters) using the dial pad. The first time the users presses a key, the first letter on that key appears on the display. For example, if the user presses 2 on the dial pad, the letter A appears. If the users presses 2 a second time, the letter B appears.
9. Presses the \* key to accept the letter on the display and move to the next space.

10. Presses **#** to accept the entire label.

The message `Label saved` appears, followed by `Hang up to update display, and then Press button to program.`

11. Presses another button to program, or
12. Hangs up the phone to exit programming. Pressing the EXIT button does not exit program mode.

 **NOTE:**

If a user makes a mistake while programming, the only way to correct it is to press the “#” key to save the entry, and start over.

Users can follow similar steps to program AD numbers for hardkey buttons. When prompted for the button to program, the user presses the desired hardkey, enters the number, and presses # to save the number.

## Considerations

---

- AD provides easy access to selected numbers by decreasing the number of dialed digits required to place the call. Instead of dialing the entire number, the user dials a short code to access the number. The system then dials the stored number automatically. For frequently called numbers, an AD button or automatic-dialing button can be assigned, allowing the call to be placed by pressing the button. By assigning a privileged list of numbers, a user is allowed to place calls to selected numbers that might otherwise be restricted.
- Users can be assigned access to three AD lists. The three lists can be made up of any combination of up to three personal lists, up to three group-number lists, the system-number list, and the enhanced-number list. A personal list cannot be administered to an attendant console.
- A number stored in any list in the switch can contain up to 24 digits. A special character used for indefinite wait, mark, pause, suppress, or wait counts as two digits.

- A terminal or attendant cannot be removed if it is designated as the extension number that is permitted to program a group-number list.



#### **SECURITY ALERT:**

*Privileged group-number, system-number, and enhanced-number lists provide access to numbers that typically would be restricted.*

## **Interactions**

---

- **Attendant Consoles**  
Automatic-dialing buttons are not allowed on attendant consoles. Attendant consoles do not have access to personal lists.
- **AUDIX Interface**  
When using an AD button to access AUDIX, the user's login and password should not be assigned to the button. The system ignores button entries after the AUDIX number.
- **Bridged Call Appearance**  
A user, accessing AD while on a bridged call appearance, accesses his or her own AD lists. The user does not access the AD lists of the primary extension associated with the bridged call appearance.  
A designated user permitted to program a group-number list is not permitted to program the group list from the bridged call appearance of the designated extension number.
- **Hotline Destination**  
The hotline service destination number is stored in an AD list.
- **Last Number Dialed**  
This feature places a call to the same number as called previously, even if AD was used on the previous call. However, if any special characters (indefinite wait, mark, pause, suppress, and wait) are included in the previous call, they are not used on the last-number-dialed call.  
If the previously called number was in an AD privileged list, and if the user is not normally allowed to dial the number because of his or her class of restriction, intercept treatment is given when using Last Number Dialed. To redial the number, the user must again use the AD privileged list.
- **Remote Access**  
Users can access the group-number, system-number, and enhanced-number AD lists via the remote-access trunk. Users of remote access can access the AD lists administered on the Console form.

## Administered Connections

---

An Administered Connection (AC) is a connection between two access or data endpoints. DEFINITY ECS automatically establishes the connection based on the attributes you administer. ACs provides the following capabilities.

- Support of both permanent and scheduled connections
- Auto Restoration (preserving the active session) for connections routed over Software Defined Data Network (SDDN) trunks
- Administrable retry interval (from 1 to 60 minutes) per AC
- Administrable alarm strategy per AC
- Establishment/retry/auto restoration order based on administered priority

### How to administer Administered Connections

---

#### Required forms

| Form  | Field | Page                  |
|---|-------|-----------------------|
| Data Module-general                           |       | <a href="#">6-226</a> |
| Data Line Data Module                         | ■ All | <a href="#">6-234</a> |
| — use with TN726 circuit pack                 |       |                       |
| Processor/Trunk Data Module                   | ■ All | <a href="#">6-243</a> |
| — use with MPDMs 700D, 7400B, 7400D, or 8400B |       |                       |
| — use with MTDMs 700B, 700C, 700E, or 7400A   |       |                       |
| Processor Interface Data Module               | ■ All | <a href="#">6-246</a> |
| — use with processor interface circuit packs  |       |                       |
| X.25 Data Module                              | ■ All | <a href="#">6-249</a> |
| — use with DCS networks                       |       |                       |

*Continued on next page*

**Required forms — Continued**

| <b>Form</b>  | <b>Field</b>  | <b>Page</b>           |
|--|---|-----------------------|
| 7500 Data Module<br>— use with TN556<br>ISDN-BRI or TN2198<br>ISDN-BRI circuit packs | ■ All   | <a href="#">6-252</a> |
| World Class Core BRI<br>Data Module<br>— use with wcbri                              | ■ All   | <a href="#">6-255</a> |
| DS1 Circuit Pack (trunks)<br>— use with switch node<br>carriers                      | ■ All   | <a href="#">7-79</a>  |
| Access Endpoint  | ■ All   | <a href="#">7-72</a>  |
| Trunk Groups   |   |                       |
| ISDN-BRI   | ■ All   | <a href="#">7-198</a> |
| ISDN-PRI   | ■ All   | <a href="#">7-219</a> |
| Tie  | ■ All   | <a href="#">7-262</a> |
| Class of Restriction (COR)   | ■ All   | <a href="#">5-72</a>  |
| Class of Service (COS)   | ■ All   | <a href="#">5-81</a>  |
| Dial Plan Record   | Local Node Number<br>— Number from 1–63 that matches<br>the DCS switch node number<br>and the CDR node number | <a href="#">5-99</a>  |
| Administered Connection  | All<br>— Originator (depending on<br>hardware)  | <a href="#">5-17</a>  |
| Station (multiappearance)  | Feature Button Assignments<br>— ac-alarm  | <a href="#">6-14</a>  |
| Attendant Console  | Feature Button Assignments<br>—ac-alarm   | <a href="#">5-35</a>  |

## Detailed description

---

The SDDN provides virtual private-line connectivity using the AT&T Switched Network. Access to the service is provided via an ISDN trunk group whose `Service Type` field is SDDN. The system uses the `Destination` field on the AC form to route calls when AC is active, based on associated authorized time-of-day fields.

Establish an AC between the following:

- Two endpoints on the same switch
- Two endpoints in the same private network, but on different switches
- One endpoint on the controlling switch and another endpoint off the private network

In all configurations, administer the AC on the switch having the originating endpoint. For an AC in a private network, if the two endpoints are on two different switches, normally the connection routes via AAR through tie trunks (ISDN, DS1, or analog tie trunks) and intermediate switches. If required, route the connection via ARS and Generalized Route Selection (GRS) through the public network. The call routes over associated ISDN trunks. When the far-end answers, a connection occurs between the far-end and the near-end extension in the `Originator` field on the AC form.

## Access endpoints

Access endpoints are non-signaling trunk ports. They neither generate signaling to the far-end of the trunk nor respond to signaling from the far-end. Designate an access endpoint as the originating endpoint or destination endpoint in an AC.

## Typical AC applications

The following are typical AC applications:

- A local data endpoint connection to a local or remote-access endpoint. Examples: an MPDM ACCUNET digital service connecting to SDDN via an ISDN trunk-group DS1 port; an MPDM ACCUNET digital service connecting to an ACCUNET Switched 56 Service via a DS1 port.
- A local-access endpoint connecting to a local or remote-access endpoint. Examples: a DSO cross-connect and a 4-wire leased-line modem to a 4-wire modem connection via an analog tie trunk.
- A local data endpoint connecting to a local or remote data endpoint such as a connection between two 3270 data modules.

### NOTE:

The following guidelines do not include AAR and ARS, or GRS administration information for routing AC calls over trunk groups.

See the respective feature elsewhere in this book for that information.

## Establishing Administered Connections

The originating switch attempts to establish an AC only if one of the following conditions exist:

- AC is active.
- AC is due to be active (either a permanent AC or time-of-day requirements are satisfied if it is a scheduled AC).
- Originating endpoint is in in-service or idle state.

If the originating endpoint is not in service or is idle, no activity takes place for the AC until the endpoint transitions to the desired state. The originating switch uses the destination address to route the call to the desired endpoint. When the switch establishes two or more ACs at the same time, the switch arranges the connections in order of priority.

AC attempts can fail for the following reasons:

- Resources are unavailable to route to the destination.
- A required conversion resource is not available.
- Access is denied by COR, FRL, BCC. Or, an attempt is made to route voice-band-data over SDDN trunks in the public switch network.
- Destination address is incorrect.
- Destination endpoint is busy.
- Other network or signaling failures occur.

In the event of a failure, an error is entered into the error log, which generates an alarm, if it is warranted by your alarming strategy. You can display AC failures via the status-administered connection command.

As long as an AC is due to be active, the originating switch continues to establish an AC unless the attempt fails because of an administrative error (for example, a wrong number) or service-blocking condition (for example, outgoing calls barred).

- The frequency with which failed attempts are retried is determined by the administered retry interval (1 to 60 minutes) for each AC.
- Retries are made after the retry interval has elapsed regardless of the restorable attribute of the AC.
- ACs are retried in priority order.
- When you change the time of day on the switch, an attempt is made to establish all ACs in the waiting-for-retry state.



## Dropping Administered Connections

An AC remains active until one of the following occurs:

- The AC is changed, disabled, or removed.
- The time-of-day requirements of a scheduled AC are no longer satisfied.
- One of the endpoints drops the connection. This could be because of user action (in the case of a data endpoint), maintenance activity resulting from an endpoint failure, busying out of the endpoint, or handshake failure. If the endpoints are incompatible, the connection is successful until handshake failure occurs.



### NOTE:

An AC between access endpoints remains connected even if the attached access equipment fails to handshake.

- An interruption (for example, facility failure) occurs between the endpoints.

If an AC drops because it was disabled/removed or is no longer due to be active, no action is taken. If an AC drops because of changed AC attributes, an immediate attempt is made to establish the connection with the changed attributes if it is still due to be active. Existing entries in the error/alarm log are resolved if they no longer apply. If handshake failure resulted in the dropping of the connection, in the case of an AC involving at least one data endpoint, no action is taken for that AC until the change administered-connection command is executed.

## Administered Connections failure: Auto Restoration and Fast Retry

When an active AC drops prematurely, you must invoke either auto restoration or fast retry to determine whether auto restoration is attempted for an active AC.

If you option AC for auto restoration and the connection was routed over SDDN trunks, auto restoration is attempted. During restoration, connections are maintained between the switch and both endpoints. In addition to allowing the active session to be maintained, AC also provides a high level of security by prohibiting other connections from intervening in active sessions. Auto restoration generally completes before the 60-second endpoint holdover interval. If auto restoration is successful, the call might be maintained (no guarantee). The restoration is transparent to the user with the exception of a temporary disruption of service while restoration is in progress. A successful restoration is reflected by the *restored* state on the status AC screen. Although the restoration was successful, the data session may not have been preserved.

If auto restoration is not active or if the AC is not routed over SDDN trunks, the switch immediately attempts to reestablish the connection (fast retry). The switch also attempts a retry if the originating endpoint initiated the drop. With fast retry,

connections are not maintained on both ends. Fast Retry is not attempted for an AC that was last established via fast retry, unless the AC is active for at least two minutes.

If auto restoration or fast retry fails to restore or reestablish the connection, the call drops and the AC goes into retry mode. Retry attempts continue, at the administered retry interval, as long as the AC is due to be active.

## Interactions

---

- **AAR/ARS/GRS**  
Use these features when routing an AC.
- **Abbreviated Dialing**  
Use Abbreviated Dialing entries in the `Destination` field. Entries must comply with restrictions.
- **Busy Verification of Stations and Trunks**  
This feature does not apply to access endpoints because they are used only for data.
- **Call Detail Recording**  
For an AC that uses a trunk when CDR is active, the origination extension is the originator of the call.  
CDR is not available for access endpoints.
- **Class of Restriction**  
Reserve a COR for AC endpoints and SDDN trunks. This restricts endpoints that are not involved in AC from connecting to SDDN trunks or endpoints involved in AC.
- **Class of Service/Call Forwarding**  
Assign to an AC endpoint a COS that blocks Call Forwarding activation at the endpoint.
- **Data Call Setup**  
Do not assign a default dialing destination to a data module when it is used in an AC.
- **Data Hotline**  
Do not assign a hotline destination to a data module that is used in an AC.
- **Digital Multiplexed Interface (DMI)**  
Use DMI endpoints as the destination in an AC. DMI endpoints do not have associated extensions, so do not use them as the originator in an AC.

## 4 Basic Features

### *Administered Connections*

Page 4-19

- Facility Test Calls

The feature does not apply to access endpoints because an access endpoint acts as an endpoint rather than as a trunk.
- Hunting

Do not use a hunt-group extension as the origination extension of an AC.
- Modem Pooling

If you require a modem in an AC, one is inserted automatically. If no modem is available, the connection is dropped.
- Non-Facility Associated Signaling (NFAS) and D-Channel Backup

Auto restoration for an AC that is initially routed over an NFAS facility may fail if the only backup route is over the facility on which the backup D-channel is administered. The backup D-channel may not come into service in time to handle the restoration attempt.
- Set Time Command

When you change the system time via the set time command, all scheduled ACs are examined. If the time change causes an active AC to be outside its scheduled period, the AC is dropped. If the time change causes an inactive AC to be within its scheduled period, the switch attempts to establish the AC.

If any AC (scheduled or continuous) is in retry mode and the system time changes, the switch attempts to establish the AC.
- System Measurements

Access endpoints are not measured. All other trunks in an AC are measured as usual.
- Terminal Dialing

Turn off terminal dialing for data modules involved in an AC. This prevents display of call-processing messages (INCOMING CALL,...) on the terminal.
- Trunk Groups

To invoke auto restoration, route an AC over SDDN trunks. Because a successful restoration depends on a SDDN path, keep some SDDN trunks idle.

## Administrable Language Displays

The Administrable Language Display enables the system to display voice-terminal messages in English, French, Italian, Spanish, or a user-defined language on attendant consoles and voice terminals equipped with 40-character displays.

### How to administer Administrable Language Displays

#### Required forms

| Form                         | Field              | Page                  |
|------------------------------|--------------------|-----------------------|
| Attendant Console            | ■ Display Language | <a href="#">5-35</a>  |
| Station                      |                    |                       |
| — 7404D, 7410D, 7410+        | ■ Display Language | <a href="#">6-90</a>  |
| — 7404D, 7410D, 7410+        | ■ Display Language | <a href="#">6-99</a>  |
| — 7405D                      | ■ Display Language | <a href="#">6-111</a> |
| — 7406D, 7406+, 7407D, 7407+ | ■ Display Language | <a href="#">6-130</a> |
| — 7506D, 7507D, 8510D, 8520D | ■ Display Language | <a href="#">6-180</a> |
| — 8410D, 8434D               |                    |                       |
| Language Translations        | ■ All              | <a href="#">5-193</a> |

### Detailed description

This feature allows you to select a display language for messages that appear on DCP station sets with 40-character displays and on DCP/ISDN-BRI attendant sets. You need to administer one of five language options: English (default), French, Italian, Spanish, or "user-defined." Note that the meanings of the messages do not change, only the language.

To create the user-defined language, translate the English display message set into the desired language via the change display-messages command.

### Feature displays

This section shows the English, French, Italian, and Spanish message for each feature.

#### NOTE:

When the system displays time, only the English language option uses AM/PM notation; all other languages use 24-hour time.

**Table 4-3. Automatic Wakeup**

| English  | French  | Italian   | Spanish  |
|--|---|---|--|
| <i>AUTO WAKEUP - Ext:<br/>xxxxx Time: --:-- xM</i> | <i>REVEIL AUTO. -<br/>POSTE: xxxxx<br/>HEURE: --:--</i> | <i>SERVIZIO SVEGLIA -<br/>Tel: xxxxx Ora: --:--</i> | <i>DESPERT<br/>AUTOMA - EXT:<br/>xxxxx HORA:<br/>--:--</i> |
| <i>INVALID EXTENSION -<br/>TRY AGAIN</i>           | <i>NUMERO DE POSTE<br/>EST ERRONE -<br/>REESSAYER</i>   | <i>NUMERO ERRATO -<br/>RIPETERE</i>                 | <i>EXTENSION NO<br/>VALIDO -<br/>INTENTE DE<br/>NUEVO</i>  |
| <i>WAKEUP ENTRY<br/>DENIED - INTERVAL<br/>FULL</i> | <i>DEM. REVEIL<br/>REFUSEE -<br/>INTERVALLE PLEIN</i>   | <i>SVEGLIA NON<br/>ATTIVATA - ORARIO<br/>OCCUP</i>  | <i>ENTRADA<br/>DENEGADA -<br/>INTERVALO<br/>COMPLETO</i>   |
| <i>WAKEUP ENTRY<br/>DENIED - NO<br/>PERMISSION</i> | <i>DEM. REVEIL<br/>REFUSEE - SANS<br/>AUTORISATION</i>  | <i>SVEGLIA NON<br/>ATTIVATA - NON<br/>PERMESSO</i>  | <i>ENTRADA<br/>DENEGADA -<br/>SIN PERMISO</i>              |
| <i>WAKEUP ENTRY<br/>DENIED - SYSTEM<br/>FULL</i>   | <i>DEM. REVEIL<br/>REFUSEE -<br/>ENCOMBREMMENT</i>      | <i>SVEGLIA NON<br/>ATTIVATA -<br/>CONGESTIONE</i>   | <i>ENTRADA<br/>DENEGADA -<br/>SISTEMA<br/>COMPLETO</i>     |
| <i>WAKEUP ENTRY<br/>DENIED - TOO SOON</i>          | <i>DEM. REVEIL<br/>REFUSEE - TROP<br/>TOT</i>           | <i>SVEGLIA NON<br/>ATTIVATA - TROPPO<br/>PRESTO</i> | <i>ENTRADA<br/>DENEGADA -<br/>MUY PRONTO</i>               |
| <i>WAKEUP REQUEST<br/>CANCELED</i>                 | <i>DEMANDE DE<br/>REVEIL EST<br/>ANNULEE</i>            | <i>RICHIESTA SVEGLIA<br/>CANENTRYATA</i>            | <i>SOLICITUD DE<br/>DESPERTADOR<br/>CANCELADA</i>          |
| <i>WAKEUP REQUEST<br/>CONFIRMED</i>                | <i>DEMANDE DE<br/>REVEIL EST<br/>CONFIRMEE</i>          | <i>RICHIESTA SVEGLIA<br/>CONFERMATA</i>             | <i>SOLICITUD DE<br/>DESPERTADOR<br/>CONFIRMADA</i>         |
| <i>Wakeup Call</i>                                 | <i>APPEL DE REVEIL</i>                                  | <i>Serv. Sveglia</i>                                | <i>Despierte</i>   |

**Table 4-4. ASAI**

| English                              | French                              | Italian                        | Spanish                                   |
|--------------------------------------|-------------------------------------|--------------------------------|---|
| <i>You have adjunct<br/>messages</i> | <i>MESSAGES<br/>SUPPLEMENTAIRES</i> | <i>MESSAGGI<br/>AGGIUNTIVI</i> | <i>TIENE<br/>MENSAJES<br/>ADICIONALES</i> |

**Table 4-5. Busy Verification of Terminals and Trunks**

| English               | French               | Italian                | Spanish               |
|-----------------------|----------------------|------------------------|-----------------------|
| <i>ALL MADE BUSY</i>  | <i>TOUS OCC.</i>     | <i>TUTTI OCCUPATI</i>  | <i>TODAS OCUPADAS</i> |
| <i>BRIDGED</i>        | <i>EN DERIVATION</i> | <i>OCCUPATO</i>        | <i>PUENTEADA</i>      |
| <i>DENIED</i>         | <i>INTERDIT</i>      | <i>NON PERMESSO</i>    | <i>DENEGADO</i>       |
| <i>INVALID</i>        | <i>ERRONE</i>        | <i>NON VALIDO</i>      | <i>NO VALIDO</i>      |
| <i>NO MEMBER</i>      | <i>AUCUN MEMBRE</i>  | <i>NESSUN ELEMENTO</i> | <i>NINGUN MIEMBRO</i> |
| <i>OUT OF SERVICE</i> | <i>HORS SERVICE</i>  | <i>FUORI SERVIZIO</i>  | <i>FUERA SERVICIO</i> |
| <i>RESTRICTED</i>     | <i>RESTREINT</i>     | <i>RISTRETTO</i>       | <i>RESTRINGIDO</i>    |
| <i>TERMINATED</i>     | <i>TERMINE</i>       | <i>TERMINATO</i>       | <i>TERMINADO</i>      |
| <i>TRUNK SEIZED</i>   | <i>CIRCUIT SAISI</i> | <i>GIUNZIONE IMP.</i>  | <i>ENLACE OCUPADO</i> |
| <i>VERIFIED</i>       | <i>VERIFIE</i>       | <i>VERIFICATO</i>      | <i>VERIFICADO</i>     |

### Call-Appearance designation

For each display language option, the display to indicate call appearance designation appears as:

"a =" (English)

Call-appearance buttons are designated on the display by a lower-case letter (a through z for the first 26 call-appearances, then A through Z) in position 1, followed by "=".

**Table 4-6. Call Detail Recording**

| English              | French               | Italian                | Spanish                   |
|----------------------|----------------------|------------------------|---------------------------|
| <i>CDR OVERLOAD"</i> | <i>SURCHARGE EDA</i> | <i>SVRACCARICO DAC</i> | <i>SOBRECARGA<br/>DAT</i> |

**Table 4-7. Call Progress Feedback Displays**

| English   | French                                       | Italian  | Spanish  |
|---|--|--|--|
| <i>busy</i><br>(Extension Busy,<br>Intrusion Not Allowed,<br>Call Waiting Not<br>Allowed) | <i>OCCUPE</i><br>(Occupe)                    | <i>occ</i><br>(Occupato)                       | <i>OCUPADA</i><br>(Ocupada)                    |
| <i>busy(I)</i><br>(Extension Busy,<br>Intrusion Allowed, Call<br>Waiting Not Allowed)     | <i>OCC.(E)</i><br>(Entree ligne occupe)      | <i>occ(I)</i><br>(Occupato-<br>Intrusione)     | <i>OCUP(I)</i><br>(Ocupada-<br>intrusion)      |
| <i>ringing</i><br>(Extension Ringing)   | <i>SONNE</i><br>(Libre)                      | <i>libero</i><br>(Libero)                      | <i>LIBRE</i><br>(Libero)                       |
| <i>wait</i><br>(Extension Busy,<br>Intrusion Not Allowed,<br>Call Waiting Allowed)        | <i>ATTENTE</i> (Attente)                     | <i>auat</i><br>(Autoattesa)                    | <i>ESPERA</i><br>(Espera)                      |
| <i>(I) wait</i><br>(Extension Busy,<br>Intrusion Allowed, Call<br>Waiting Allowed)        | <i>(E) ATTENTE</i><br>(Entree ligne attente) | <i>(I) auat</i><br>(Intrusione-<br>Autoattesa) | <i>(I) ESPERA</i><br>(Intrusion, en<br>espera) |

**Table 4-8. Class of Restriction Displays**

| Restriction     | English | French | Italian | Spanish |
|-----------------|---------|--------|---------|---------|
| Toll            | TOLL    | INT.   | TASS    | TARF    |
| Full            | FULL    | COM.   | DISB    | LLEN    |
| No Restrictions | NONE    | AUC.   | ABIL    | NING    |
| Origination     | ORIG    | DEP.   | ORIG    | ORIG    |
| Outward         | OTWD    | SOR.   | USCN    | SALI    |

**Table 4-9. Date/Time Mode — Time Not Available**

| English                                | French                                 | Italian                                     | Spanish  |
|--|--|---|--|
| <i>SORRY, TIME<br/>UNAVAILABLE NOW</i> | <i>HEURE ET DATE<br/>INDISPONIBLES</i> | <i>ORA E DATA<br/>TEMPO<br/>DISPONIBILI</i> | <i>HORA Y FECHA<br/>NO<br/>DISPONIBLES<br/>AHORA</i> |

4 Basic Features

Administrable Language Displays

If time is available, you see the following screens.

```

    <DATE/TIME>      <TIME><b><b><DATE>
    <TIME>          <HR>:<MIN><b><M>
    <HR>            1-12 (hour of day, no leading zeroes)
    <MIN>           00-59 (minute of hour)
    <M>             "am" or "pm"
    <DATE>          <DOW><b><MONTH><b><DOM>,<b><YEAR>
    <DOW>           Day of week, upper case, unabbreviated
    <MONTH>         Month of year, upper case, unabbreviated
    <DOM>           1-31 (day of month, no leading zeroes)
    <YEAR>          Year in 4 digits
    <b>              Blank
    
```

Screen 4-1. Date/Time Mode and Formats – English

```

    <DATE/TIME>      <TIME><b><b><DATE>
    <TIME>          <HR>:<MIN>
    <HR>            0-23 (hour of day, no leading zeroes)
    <MIN>           00-59 (minute of hour)
    <DATE>          <DOW><b><DOM><b><MONTH>,<b><YEAR>
    <DOW>           Day of week, upper case, unabbreviated
    <DOM>           1-31 (day of month, no leading zeroes)
    <MONTH>         Month of year, upper case, unabbreviated
    <YEAR>          Year in 4 digits
    <b>              Blank
    
```

Screen 4-2. Date/Time Mode and Formats – French, Italian, Spanish, and User-Defined

Table 4-10. Days of the Week Format

| English   | French   | Italian   | Spanish   |
|-----------|----------|-----------|-----------|
| SUNDAY    | DIMANCHE | DOMENICA  | DOMINGO   |
| MONDAY    | LUNDI    | LUNEDI    | LUNES     |
| TUESDAY   | MARDI    | MARTEDI   | MARTES    |
| WEDNESDAY | MERCREDI | MERCOLEDI | MIERCOLES |
| THURSDAY  | JEUDI    | GIOVEDI   | JUEVES    |
| FRIDAY    | VENDREDI | VENERDI   | VIERNES   |
| SATURDAY  | SAMEDI   | SABATO    | SABADO    |



**Table 4-11. Months of the Year Format**

| <b>English</b> | <b>French</b> | <b>Italian</b> | <b>Spanish</b> |
|----------------|---------------|----------------|----------------|
| JANUARY        | JANVIER       | GENNAIO        | ENERO          |
| FEBRUARY       | FEVRIER       | FEBBRAIO       | FEBRERO        |
| MARCH          | MARS          | MARZO          | MARZO          |
| APRIL          | AVRIL         | APRILE         | ABRIL          |
| MAY            | MAI           | MAGGIO         | MAYO           |
| JUNE           | JUIN          | GIUGNO         | JUNIO          |
| JULY           | JUILLET       | LUGLIO         | JULIO          |
| AUGUST         | AOUT          | AGOSTO         | AGOSTO         |
| SEPTEMBER      | SEPTEMBRE     | SETTEMBRE      | SEPTIEMBRE     |
| OCTOBER        | OCTOBRE       | OTTOBRE        | OCTUBRE        |
| NOVEMBER       | NOVEMBRE      | NOVEMBRE       | NOVIEMBRE      |
| DECEMBER       | DECEMBRE      | DICEMBRE       | DICIEMBRE      |

**Table 4-12. Do Not Disturb (Hotel/Motel Feature)**

| <b>English</b>  | <b>French</b>   | <b>Italian</b>                                      | <b>Spanish</b>   |
|---|---|---|--|
| <i>DO NOT DIST -<br/>Group: xx Time: --:--<br/>xM</i>   | <i>NE PAS DERANGER<br/>GROUPE: xx<br/>HEURE: --:--</i>  | <i>NON DISTURBARE -<br/>Grp: xx Ora: --:--</i>      | <i>NO MOLESTAR -<br/>GRUPO: xx HORA:<br/>--:--</i>       |
| <i>DO NOT DIST - Ext:<br/>xxxxx Time: --:-- xM</i>      | <i>NE PAS DERANGER<br/>POSTE:xxxxx<br/>HEURE: --:--</i> | <i>NON DISTURBARE -<br/>Tel: xxxxx Ora: --:--</i>   | <i>NO MOLESTAR -<br/>EXT: xxxxx HORA:<br/>--:--</i>      |
| <i>DO NOT DIST ENTRY<br/>DENIED - INTERVAL<br/>FULL</i> | <i>DEMANDE EST<br/>REFUSEE -<br/>INTERVALLE PLEIN</i>   | <i>SERVIZIO NON<br/>ATTIVATO - ORARIO<br/>OCCUP</i> | <i>ENTRADA<br/>DENEGADA -<br/>INTERVALO<br/>COMPLETO</i> |
| <i>DO NOT DIST ENTRY<br/>DENIED - NO<br/>PERMISSION</i> | <i>DEMANDE EST<br/>REFUSEE - SANS<br/>AUTORISATION</i>  | <i>SERVIZIO NON<br/>ATTIVATO - NON<br/>PERMESSO</i> | <i>ENTRADA<br/>DENEGADA - SIN<br/>PERMISO</i>            |
| <i>DO NOT DIST ENTRY<br/>DENIED - SYSTEM<br/>FULL</i>   | <i>DEMANDE EST<br/>REFUSEE -<br/>ENCOMBREMENT</i>       | <i>SERVIZIO NON<br/>ATTIVATO -<br/>CONGESTIONE</i>  | <i>ENTRADA<br/>DENEGADA -<br/>SISTEMA<br/>COMPLETO</i>   |

*Continued on next page*

**Table 4-12. Do Not Disturb (Hotel/Motel Feature) — Continued**

| English  | French                               | Italian                                      | Spanish                                    |
|--|--------------------------------------|--|--|
| DO NOT DIST ENTRY<br>DENIED - TOO SOON         | DEMANDE EST<br>REFUSEE - TROP<br>TOT | SERVIZIO NON<br>ATTIVATO - TROPPO<br>PRESTO  | ENTRADA<br>DENEGADA - MUY<br>PRONTO        |
| INVALID GROUP -<br>TRY AGAIN                   | GROUPE ERRONE -<br>REESSAYER         | GRUPPO NON<br>VALIDO - RIPETERE              | GRUPO NO VALIDO -<br>INTENTE DE NUEVO      |
| THANK YOU - DO<br>NOT DIST ENTRY<br>CONFIRMED  | MERCI - DEMANDE<br>EST CONFIRMEE     | NON DISTURBARE -<br>RICHIESTA<br>CONFIRMATA  | NO MOLESTAR -<br>ENTRADA<br>CONFIRMADA     |
| THANK YOU - DO<br>NOT DIST REQUEST<br>CANCELED | MERCI - DEMANDE<br>EST ANNULEE       | NON DISTURBARE -<br>RICHIESTA<br>CANENTRYATA | MUCHAS GRACIAS -<br>SOLICITUD<br>CANCELADA |

### Enhanced Abbreviated Dialing

Page 1 of 1

Language Translations

English

|                                    |           |
|------------------------------------|-----------|
| 1. Press button to program.        | 1. *****  |
| 2. Change number?                  | 2. *****  |
| 3. Yes=1 No=2                      | 3. *****  |
| 4. Enter number:                   | 4. *****  |
| 5. Press # to save.                | 5. *****  |
| 6. Number saved.                   | 6. *****  |
| 7. Change label?                   | 7. *****  |
| 8. Enter label:                    | 8. *****  |
| 9. Press * to advance; # to save.  | 9. *****  |
| 10. Press * to reenter; # to save. | 10. ***** |
| 11. Label saved.                   | 11. ***** |

Use this form to define the “user-defined language” for enhanced abbreviated dialing. On the Station form, set the Display Language field to user-defined so your language translations appear on the terminal display.

**4 Basic Features**

*Administrable Language Displays*

**Table 4-13. Field Separator**

| <b>English</b>                         | <b>French</b>                         | <b>Italian</b>                        | <b>Spanish</b>                           |
|--|---------------------------------------|---------------------------------------|--|
| <calling party> "to"<br><called party> | <calling party> "a"<br><called party> | <calling party> "a"<br><called party> | <calling party><br>"a" <called<br>party> |

**Table 4-14. Integrated Directory Display Model**

| <b>English</b>                                   | <b>French</b>                                    | <b>Italian</b>                                     | <b>Spanish</b>   |
|--|--|--|--|
| <i>DIRECTORY -<br/>PLEASE ENTER NAME</i>         | <i>ANNUAIRE - ENTRER<br/>LE NOM</i>              | <i>ELENCO UTENTI -<br/>INTRODURRE NOME</i>         | <i>GUIA<br/>TELEFONICA -<br/>INTRODUZCA<br/>NOMBRE</i>     |
| <i>DIRECTORY<br/>UNAVAILABLE - TRY<br/>LATER</i> | <i>ANNUAIRE<br/>INDISPONIBLE -<br/>REESSAYER</i> | <i>ELENCO UTENTI<br/>TEMP. NON<br/>DISPONIBILE</i> | <i>GUIA TEL<br/>INDISPONIBLE<br/>- INTENTE<br/>DESPUES</i> |
| <i>NO MATCH - TRY<br/>AGAIN</i>                  | <i>INTROUVABLE -<br/>REESSAYER</i>               | <i>NESSUNA<br/>CORRISPONDENZA -<br/>RIPETERE</i>   | <i>NO<br/>CORRESPONDE<br/>- INTENTE DE<br/>NUEVO</i>       |

**Table 4-15. ISDN**

| <b>English</b>     | <b>French</b>      | <b>Italian</b>     | <b>Spanish</b>            |
|--------------------|--------------------|--------------------|---------------------------|
| <i>ANSWERED BY</i> | <i>REPONDU PAR</i> | <i>RISPOSTA DA</i> | <i>RESPONDIDO<br/>POR</i> |
| <i>CALL FROM</i>   | <i>APPEL DE</i>    | <i>CHIAMATA DA</i> | <i>LLAMADA DE</i>         |
| <i>INTL</i>        | <i>INTL</i>        | <i>INTL</i>        | <i>INTL</i>               |

## 4 Basic Features

### Administrable Language Displays

Page 4-28

## Leave Word Calling

```
<CALLER_ID><b><DATE><b><TIME><M><b><C><b>CALL<EXT_NO>

<CALLER_ID>      The calling identifier, up to 15 characters
<DATE>           <MONTH>/<DOM>
<MONTH>          1-12 (month of year, no leading zeroes)
<DOM>            1-31 (day of month, no leading zeroes)
<TIME>           <HR>:<MIN>
<HR>             1-12 (hour of day, no leading zeroes)
<MIN>            00-59 (minute of hour)
<M>              "a" or "p"
<C>              Number of calls received, 1 digit *
<EXT_NO>         Calling extension number, up to 5 digits
<b>              blank
```

### Screen 4-3. Leave Word Calling Format – English

```
<CALLER_ID><b><DATE><b><TIME><b><C><b>APPL<b><EXT_NO>

<CALLER_ID>      The calling identifier, up to 15 characters
<DATE>           <DOM>/<MONTH>
<DOM>            1-31 (day of month, no leading zeroes)
<MONTH>          1-12 (month of year, no leading zeroes)
<TIME>           <HR>:<MIN>
<HR>             0-23 (hour of day, no leading zeroes)
<MIN>            00-59 (minute of hour)
<C>              Number of calls received, 1 digit *
<EXT_NO>         Calling extension number, up to 5 digits
```

### Screen 4-4. Leave Word Calling Formats – French, Italian, Spanish, and User-Defined

4 Basic Features

Administrable Language Displays

Table 4-16. Leave Word Calling Messages

| English                                 | French                                   | Italian                                   | Spanish                                  |
|---|--|---|--|
| CANNOT BE DELETED - CALL MESSAGE CENTER | NE PEUT ETRE SUPP./APPELER RECEP. MESS.  | NON CANENTRYATO. CHIAMARE CENTRO MESSAGGI | NO ELIMINADO-LLAMA CENTRO DE MENSAJES    |
| DELETED                                 | SUPPRIME                                 | MESSAGGIO CANENTRYATO                     | ELIMINADO                                |
| END OF MESSAGES (NEXT TO REPEAT)        | FIN DES MESSAGES (SUIVANT POUR REPETER)  | FINE MESSAGGI. <successivo> PER RIPETERE  | FIN DE MENSAJES (SIGUIENTE PARA REPITIR) |
| GET DIAL TONE, PUSH Cover Msg Retrieval | TONALITE D'ENVOI - <LECT. MESS. COUV.>   | <rec mess copert> DOPO IL TONO DI CENTR   | OBTENGA TONO OPRIMA <RECUP MNSJE COBERT> |
| IN PROGRESS                             | EN COURS                                 | ATTENDERE...                              | EN CURSO                                 |
| MESSAGE RETRIEVAL DENIED                | LECTURE DE MESSAGES INTERDITE            | LETTURA MESSAGGIO NON PERMESSA            | RECUPERACION DE MENSAJES DENEGADA        |
| MESSAGE RETRIEVAL LOCKED                | LECTURE DE MESSAGES BLOQUEE              | LETTURA MESSAGGIO BLOCCATA                | RECUPERACION DE MENSAJES BLOQUEADA       |
| MESSAGES FOR                            | MESSAGES POUR                            | MESSAGGI PER                              | MENSAJES PARA                            |
| MESSAGES UNAVAILABLE - TRY LATER        | MESSAGES INDISPONIBLES - REESSAYER       | MESSAGGI TEMPORANEAMENT E NON DISPONIBILI | MENSAJES NO DISPONIBLES, INTENTE DESPUES |
| Message Center (AUDIX) CALL             | APPEL DE LA RECEPTION DE MESS. (AUDIX)   | Chiamata dal Centro Messaggi (AUDIX)      | LLAMADA DEL CENTRO DE MENSAJES (AUDIX)   |
| NO MESSAGES                             | PAS DE MESSAGES                          | NESSUN MESSAGGIO                          | NINGUN MENSAJE                           |
| WHOSE MESSAGES? (DIAL EXTENSION NUMBER) | MESSAGES DE QUEL NO.? (ENTRER NO. POSTE) | LETTURA MESSAGGI. INTRODURRE NUMERO TEL.  | MENSAJES DE QUIEN? (MARCAR EXTENSION)    |

**Table 4-17. Malicious Call Trace**

| English                           | French  | Italian   | Spanish                                      |
|-----------------------------------|---|---|--|
| MALICIOUS CALL<br>TRACE REQUEST   | DEPISTAGE<br>D'APPELS<br>MALVEILLANTS           | RICHIESTA<br>RINTRACCIO<br>CHIAMATE<br>MALEVOLE | RASTREO DE<br>LLAMADA<br>MALINTENCION<br>ADA |
| MCT activated by: for:            | DAM ACTIVE par:<br>pour:                        | RCM attivato da: per:                           | RLM activada<br>por: para:                   |
| original call redirected<br>from: | redirection appel<br>initial de:<br>(EXTENSION) | chiamata iniziale<br>rinviata da:               | llamada orig.<br>transferida de:             |
| party: (EXTENSION)                | demandeur:<br>(EXTENSION)                       | utente: (INTERNO)                               | usuario:<br>(EXTENSION)                      |
| party: (ISDN SID/CNI)             | demandeur:<br>(NIP/INA ISDN)                    | utente: (NIC/INC<br>ISDN)                       | usuario: (ISDN<br>NIE/INU)                   |
| party: (PORT ID)                  | demandeur: (REF.<br>PORT ISDN)                  | utente: (ID DELLA<br>PORTA ISDN)                | usuario: (ID<br>DEL PUERTO<br>ISDN)          |
| party: (ISDN PORT ID)             | demandeur: (REF.<br>PORT)                       | utente: (ID DELLA<br>PORTA)                     | usuario: (ID<br>DEL PUERTO)                  |
| END OF TRACE<br>INFORMATION       | FIN DES INFO DE<br>DEPISTAGE                    | INFORMAZIONI<br>FINALI SUL<br>RINTRACCIO        | FIN DE<br>INFORMACION<br>DE RASTREO          |
| voice recorder port:              | port enregistreur<br>vocal:                     | porta del registratore:                         | puerto de<br>grabado de voz:                 |

**Table 4-18. Caller Information**

| English | French | Italian | Spanish |
|---------|--------|---------|---------|
| Info:   | INFO.: | Info:   | INFORM: |

**Table 4-19. Emergency Access to Attendant**

| English                                      | French   | Italian  | Spanish   |
|--|--|--|---|
| a=xxxxxxxxxxxxxxxx Ext<br>xxxxx xx in EMRG Q | a=xxxxxxxxxxxxxxxx<br>POSTE xxxxxx xx FIL<br>URG | a=xxxxxxxxxxxxxxxx<br>Der xxxxxx xx in C<br>EMRG | a=xxxxxxxxxxxxx<br>xxx EXT xxxxxx<br>xx EN C EMRG |

4 Basic Features

Administrable Language Displays

Table 4-20. Queue Status

| English                            | French                                  | Italian                        | Spanish                                     |
|------------------------------------|---|--------------------------------|---|
| HUNT GROUP <x><br>NOT ADMINISTERED | GRUPE DE DIST.<br><x> NON<br>ADMINISTRE | GRUPPO <x> NON<br>AMMINISTRATO | GRUPO<br>BUSQUEDA<br><x> NO<br>ADMINISTRADO |

Table 4-21. Queue Status Indication

| English                            | French                               | Italian                            | Spanish                                  |
|------------------------------------|--------------------------------------|------------------------------------|--|
| <15 chrs> Q-time<br>xx:xx calls xx | <15 chrs> TEMPS-F<br>xx:xx APPELS xx | <15 chrs> T-coda<br>xx:xx chiam xx | <15 chrs><br>HORA-C xx:xx<br>LLAMADAS xx |

Table 4-22. Miscellaneous Call Identifier

| English                               | French                            | Italian                         | Spanish                       |
|---------------------------------------|-----------------------------------|---------------------------------|-------------------------------|
| sa<br>(ACD Supervisor Assistance)     | AS<br>(Assistance surveillant)    | as<br>(Assistenza Supervisoree) | AS<br>(Ayuda de supervisor)   |
| ac<br>(Attd Assistance Call)          | AA<br>(Appel assistance)          | ao<br>(Assistenza Operatore)    | AO<br>(Ayuda de operadora)    |
| tc<br>(Attd Control Of A Trunk Group) | CF<br>(Commande faisceau)         | fc<br>(Fascio Controllato)      | CE<br>(Control enlaces)       |
| an<br>(Attd No Answer)                | TR<br>(Telephoniste sans reponse) | on<br>(Operatore Non Risponde)  | ON<br>(Operadora no responde) |
| pc<br>(Attd Personal Call)            | AP<br>(Appel personnel)           | cp<br>(Chiamata Personale)      | LP<br>(Llamada personal)      |
| rc<br>(Attd Recall Call)              | RA<br>(Rappel)                    | rc<br>(Richiamata)              | RL<br>(Rellamada)             |
| rt<br>(Attd Return Call)              | RE<br>(Retour)                    | rt<br>(Ritornata)               | RT<br>(Retorno)               |

Continued on next page

4 Basic Features

Administrable Language Displays

**Table 4-22. Miscellaneous Call Identifier — Continued**

| English  | French   | Italian                                  | Spanish   |
|--|--|--|---|
| <i>sc</i><br>(Attd Serial Call)                          | <i>AS</i><br>(Appel en serie)                  | <i>ic</i><br>(Inoltro a Catena)          | <i>LS</i><br>(Llamada en serie)                 |
| <i>co</i><br>(Controlled Outward Restriction)            | <i>RD</i><br>(Restriction de depart)           | <i>cu</i><br>(Controllata Uscente)       | <i>RS</i><br>(Restriccion saliente)             |
| <i>cs</i><br>(Controlled Station to Station Restriction) | <i>RP</i><br>(Restriction vers postes)         | <i>cd</i><br>(Controllata Derivati)      | <i>CS</i><br>(Control estacion)                 |
| <i>ct</i><br>(Controlled Termination Restriction)        | <i>AR</i><br>(Restriction d'arrivee)           | <i>ct</i><br>(Controllata Terminante)    | <i>RE</i><br>(Restriccion entrante)             |
| <i>db</i><br>(DID Find Busy Station With CO Tones)       | <i>OP</i><br>(Occupation du poste)             | <i>po</i><br>(Passante Occupata)         | <i>EO</i><br>(Estacion ocupada)                 |
| <i>da</i><br>(DID Recall Go To Attd)                     | <i>RT</i><br>(Rappel telephoniste)             | <i>pr</i><br>(Richiamata su Passante)    | <i>RD</i><br>(Rellamada directa)                |
| <i>qf</i><br>(Emerg. Queue Full Redirection)             | <i>FP</i><br>(File d'urgence pleine deviation) | <i>de</i><br>(Deviata Emergenza)         | <i>DE</i><br>(Desvio de emergencia)             |
| <i>hc</i><br>(Held Call Timed Reminder)                  | <i>AG</i><br>(Indicatif d'appel en garde)      | <i>at</i><br>(Avviso Chiamata in tenuta) | <i>LR</i><br>(Recordatorio de llamada retenida) |
| <i>ic</i><br>(Intercept)                                 | <i>IN</i><br>(Interception)                    | <i>in</i><br>(Intercettata)              | <i>IN</i><br>(Intercepcion)                     |
| <i>ip</i><br>(Interposition Call)                        | <i>AI</i><br>(Appel interposition)             | <i>ip</i><br>(Interposizione)            | <i>EP</i><br>(Entre posiciones)                 |
| <i>ld</i><br>(LDN Calls on DID Trunks)                   | <i>SD</i><br>(Selection directe)               | <i>pd</i><br>(Diretta Passante)          | <i>LD</i><br>(Larga distancia)                  |
| <i>so</i><br>(Service Observing)                         | <i>ES</i><br>(ecoute du service)               | <i>is</i><br>(Inclusione Supervisore)    | <i>SS</i><br>(Supervision del servicio)         |
| <i>na</i><br>(Unanswered or Incomplete DID Call)         | <i>SR</i><br>(Sans reponse)                    | <i>pn</i><br>(Passante Non Risposta)     | <i>SR</i><br>(Sin respuesta)                    |
| <i>ACB</i><br>(Automatic Callback)                       | <i>R. AUTO.</i><br>(Rappel automatique)        | <i>PRN</i><br>(Prenotazione Automatica)  | <i>RA</i><br>(Rellamada automatica)             |
| <i>callback</i><br>(Callback Call)                       | <i>RAPPEL</i><br>(Rappel)                      | <i>prenotaz</i><br>(Prenotazione)        | <i>RELLAM</i><br>(Rellamada)                    |

Continued on next page



**Table 4-22. Miscellaneous Call Identifier — Continued**

| English  | French  | Italian   | Spanish  |
|--|---|---|--|
| <i>park</i><br>(Call Park)                         | <i>G. I.</i><br>(garde par) indicatif                   | <i>parch.</i><br>(Parcheggiata)                 | <i>ESTAC</i><br>(Estacionamiento de llamada)   |
| <i>control</i><br>(Control)                        | <i>CONTROLE</i><br>(Controle)                           | <i>cntr.op.</i><br>(Controllo Operatore)        | <i>CONTROL</i><br>(Control)                    |
| <i>ICOM</i><br>(Intercom Call)                     | <i>INTERCOM</i><br>(Intercommunication)                 | <i>ICOM</i><br>(Intercom)                       | <i>INTERF</i><br>(Llamda interfono)            |
| <i>OTQ</i><br>(Outgoing Trunk Queuing)             | <i>FFD</i><br>(File faisceaux de depart)                | <i>RFO</i><br>(Richiamata su Fascio Occupato)   | <i>EES</i><br>(Espera de enlace de salida)     |
| <i>priority</i><br>(Priority Call)                 | <i>PRIORITE</i><br>(Appel prioritaire)                  | <i>priorita</i><br>(Priorita')                  | <i>PRIORIT</i><br>(Llamada prioritaria)        |
| <i>recall</i><br>(Recall Call)                     | <i>APP.RAP.</i><br>(Appel rappel)                       | <i>richiam</i><br>(Richiamata)                  | <i>REPET</i><br>(Rellamada)                    |
| <i>return</i><br>(Return Call)                     | <i>RETOUR</i><br>(Retour)                               | <i>ritorno</i><br>(Chiamata Ritornata)          | <i>RETORNO</i><br>(Llamada de retorno)         |
| <i>ARS</i><br>(Automatic Route Selection)          | <i>SAA</i><br>(Selection de l'acheminement automatique) | <i>SAI</i><br>(Selez. Autom. Intradam.)         | <i>SAR</i><br>(Seleccion automatica de rutas)  |
| <i>forward</i><br>(Call Forwarding)                | <i>RENVOI</i><br>(Renvoi)                               | <i>deviata</i><br>(Deviata)                     | <i>REENVIO</i><br>(Reenvio de llamada)         |
| <i>cover</i><br>(Cover)                            | <i>SUPPL.</i><br>(Suppleance)                           | <i>copert.</i><br>(Copertura)                   | <i>COBER</i><br>(Cobertura)                    |
| <i>DND</i><br>(Do Not Disturb)                     | <i>NPD</i><br>(Ne pas deranger)                         | <i>nd</i><br>(Non Disturbare)                   | <i>NM</i><br>(No molestar)                     |
| <i>p</i><br>(Call Pickup)                          | <i>P</i><br>(Prise)                                     | <i>a</i><br>(Assente)                           | <i>C</i><br>(Captura de llamada)               |
| <i>c</i><br>(Cover All Calls)                      | <i>s</i><br>(Suppleance)                                | <i>c</i><br>(Copertura)                         | <i>c</i><br>(Cobertura de toda llamada)        |
| <i>n</i><br>(Night Sta. Serv., Incoming No Answer) | <i>N</i><br>(Service nuit, entrant pas reponse)         | <i>n</i><br>(Serv. Notte, Esterna Non Risposta) | <i>N</i><br>(Servicion noct. ext. no responde) |
| <i>B</i><br>(All Calls Busy)                       | <i>O</i><br>(Tous occupes)                              | <i>O</i><br>(Tutte Occupate)                    | <i>O</i><br>(Todas ocupadas)                   |
| <i>f</i><br>(Call Forwarding)                      | <i>R</i><br>(Renvoi)                                    | <i>d</i><br>(Deviata)                           | <i>R</i><br>(Reenvio de llamada)               |

*Continued on next page*

**Table 4-22. Miscellaneous Call Identifier — Continued**

| English                          | French                                  | Italian                                  | Spanish                               |
|----------------------------------|---|--|---------------------------------------|
| <i>b</i><br>(Cover Busy)         | <i>o</i><br>(Suppléance occupée)        | <i>o</i><br>(Copertura per Occupato)     | <i>o</i><br>(Cobertura ocupada)       |
| <i>d</i><br>(Cover Don't Answer) | <i>n</i><br>(Suppléance pas de réponse) | <i>n</i><br>(Copertura per Non Risposta) | <i>n</i><br>(Cobertura sin respuesta) |
| <i>s</i><br>(Send All Calls)     | <i>E</i><br>(Envoi tous appels)         | <i>r</i><br>(Rinvio)                     | <i>E</i><br>(Envio de toda llamada)   |

**Table 4-23. Party Identifiers**

| English      | French       | Italian       | Spanish      | Identifier               |
|--------------|--------------|---------------|--------------|--------------------------|
| OPERATOR     | TELEPHONISTE | OPERATORE     | OPERADORA    | Attendant <sup>1</sup>   |
| CONFERENCE   | CONFERENCE   | CONFERENZA    | CONFERENCIA  | Conference Call          |
| EXT          | POSTE        | DER           | EXTENSION    | Extension                |
| PAGING       | PAGING       | PAGING        | PAGING       | Paging <sup>2</sup>      |
| OUTSIDE CALL | APPEL EXT.   | ESTERNA       | LLAMADA EXT. | Trunk Group <sup>1</sup> |
| UNKNOWN NAME | INTROUVABLE  | NOME SCONOSC. | DESCONOCIDO  | Unknown                  |

1. If these displays are associated with a DCS call, you can administer the displays and they will appear translated. If the displays are not associated with a DCS call, the name that appears is the name administered on the form used to administer the trunk group.
2. You cannot translate this display.

**Table 4-24. Property Management System Interface**

| English                                       | French   | Italian   | Spanish                                       |
|---|--|---|---|
| CHECK IN - Ext:                               | ENREGISTREMENT -<br>POSTE:                     | CHECK IN - Tel:                                   | REGISTRARSE -<br>EXTENSION:                   |
| CHECK IN: ROOM<br>ALREADY<br>OCCUPIED         | ENREGISTREMENT:<br>CHAMBRE<br>OCCUPEE          | CHECK IN: CAMERA<br>OCCUPATA                      | REGISTRARSE:<br>HABITACION<br>OCUPADA         |
| CHECK IN<br>COMPLETE                          | ENREGISTREMENT<br>EFFECTUE                     | CHECK IN<br>COMPLETATO                            | REGISTRO<br>TERMINADO                         |
| CHECK IN FAILED                               | ECHEC<br>D'ENREGISTREMENT                      | CHECK IN ERRATO                                   | REGISTRARSE:<br>FALLIDO                       |
| CHECK OUT - Ext:                              | DEPART - POSTE:                                | CHECK OUT - Tel:                                  | PAGAR LA CUENTA -<br>EXTENSION:               |
| CHECK OUT<br>COMPLETE:<br>MESSAGE LAMP<br>OFF | DEPART: PAS DE<br>MESSAGES                     | CHECK OUT<br>COMPLETATO:<br>NESSUN<br>MESSAGGIO   | PAGO TERMINADO:<br>NINGUN MENSAJE             |
| CHECK OUT<br>COMPLETE:<br>MESSAGE LAMP ON     | DEPART: MESSAGES                               | CHECK OUT<br>COMPLETATO:<br>MESSAGGI IN<br>ATTESA | PAGO DE CUENTA<br>TERMINADO:<br>MENSAJES      |
| CHECK OUT FAILED                              | ECHEC<br>PROCEDURE DE<br>DEPART                | CHECK OUT<br>ERRATO                               | PAGAR LA CUENTA:<br>FALLIDO                   |
| CHECK OUT: ROOM<br>ALREADY VACANT             | DEPART - CHAMBRE<br>INOCCUPEE                  | CHECK OUT:<br>CAMERA NON<br>OCCUPATA              | PAGAR LA CUENTA:<br>HABITACION<br>VACANTE     |
| MESSAGE LAMP<br>OFF                           | PAS DE MESSAGES                                | NESSUN<br>MESSAGGIO IN<br>ATTESA                  | LUZ DE MENSAJE<br>APAGADA                     |
| MESSAGE LAMP ON                               | MESSAGES                                       | MESSAGGI IN<br>ATTESA                             | LUZ DE MENSAJE<br>ENCENDIDA                   |
| MESSAGE<br>NOTIFICATION<br>FAILED             | ECHEC D'AVIS<br>MESSAGES                       | NOTIFICA<br>MESSAGGI ERRATA                       | AVISO DE MENSAJE<br>FALLIDO                   |
| MESSAGE<br>NOTIFICATION OFF<br>- Ext: xxxxx   | AVIS DE MESSAGES<br>DESACTIVE -<br>POSTE:xxxxx | NOTIFICA<br>MESSAGGI DISABIL.<br>- Tel: xxxxx     | AVISO DE MENSAJE<br>APAGADO - EXT:<br>xxxxx   |
| MESSAGE<br>NOTIFICATION ON -<br>Ext: xxxxx    | AVIS DE MESSAGES<br>ACTIVE -<br>POSTE:xxxxx    | NOTIFICA<br>MESSAGGI<br>ABILITATA - Tel:<br>xxxxx | AVISO DE MENSAJE<br>ENCENDIDO - EXT:<br>xxxxx |

4 Basic Features

Administrable Language Displays

**Table 4-25. Security Violation Notification**

| English                                | French   | Italian   | Spanish                                      |
|--|--|---|--|
| <i>Barrier Code Violation</i>          | <i>VIOLATION DU CODE D'ENTREE</i>              | <i>VIOLAZIONE DI CODICI DE TAGLIO</i>           | <i>VIOLACION CONDIGO LIMITE</i>              |
| <i>Login Violation</i>                 | <i>VIOLATION DE L'ACCES A L'ADMINISTRATION</i> | <i>IOLAZIONE DI INIZIO DI REGISTRAZIONE</i>     | <i>VIOLACION CLAVE ACCESO</i>                |
| <i>Station Security Code Violation</i> | <i>VIOLATION DE CODE D'ACCESS DE SECURITE</i>  | <i>VIOLAZIONE DI CODICE DE SICUREZZA UTENTE</i> | <i>VIOLACION DE SEGURIDAD DE LA ESTACION</i> |
| <i>Authorization Code Violation</i>    | <i>VIOLATION DEU CODE ACCES</i>                | <i>VIOLAZION DEL CODICE D'AUTORIZZAZIONE</i>    | <i>VIOLACION DE CODIGO DE AUTORIZACION</i>   |

**Table 4-26. Stored Number**

| English                 | French                         | Italian                         | Spanish                         |
|-------------------------|--------------------------------|---------------------------------|---------------------------------|
| <i>NO NUMBER STORED</i> | <i>AUCUN NUMERO EN MEMOIRE</i> | <i>NESSUN NUMERO IN MEMORIA</i> | <i>NINGUN NUMERO ALMACENADO</i> |

**Table 4-27. Special Codes<sup>1</sup>**

| English                       | French                  | Italian                 | Spanish                |
|-------------------------------|-------------------------|-------------------------|------------------------|
| <i>m</i><br>(Mark)            | <i>M</i><br>(Marquer)   | <i>m</i><br>(Marcato)   | <i>M</i><br>(Marca)    |
| <i>p</i><br>(Pause)           | <i>P</i><br>(Pause)     | <i>p</i><br>(Pausa)     | <i>P</i><br>(Pausa)    |
| <i>s</i><br>(Suppress)        | <i>S</i><br>(Supprimer) | <i>s</i><br>(Soppresso) | <i>S</i><br>(Suprimir) |
| <i>w</i><br>(Wait)            | <i>A</i><br>(Attendre)  | <i>a</i><br>(Attesa)    | <i>E</i><br>(Espera)   |
| <i>W</i><br>(Indefinite Wait) | <i>a</i><br>(Attendre)  | <i>A</i><br>(Attesa)    | <i>e</i><br>(Espera)   |

- 
1. The system does not change numeric and touch-tone characters before it displays them.
- 

## Station Hunting

Table 4-28. Calling Party Display

---

| English     | French         | Italian        | Spanish         |
|-------------|----------------|----------------|-----------------|
| <i>HUNT</i> | <i>Routage</i> | <i>Ricerca</i> | <i>Busqueda</i> |

---

Table 4-29. Hunt-to Station Display

---

| English  | French   | Italian  | Spanish  |
|----------|----------|----------|----------|
| <i>h</i> | <i>r</i> | <i>r</i> | <i>b</i> |

---

In the following displays, x and y denote the Route Plan Number (RPN 1-8), yyy is a 3-letter abbreviation for the day of the week, and zz:zz is the activation time (24-hour time). [Table 4-31](#) lists the 3-letter abbreviations for the day of the week.

**Table 4-30. Time-of-Day Routing Messages**

| English                                       | French  | Italian  | Spanish  |
|---|---|--|--|
| ENTER ACTIVATION<br>ROUTE PLAN, DAY &<br>TIME | ENTRER PLAN<br>D'ACTIVATION,<br>JOUR ET HEURE | INTRODURRE PIANO<br>DA ATTIV., GIORNO E<br>ORA | INTRODUZCA<br>PLAN ACT DE<br>RUTAS, DIA Y<br>HORA  |
| ENTER<br>DEACTIVATION DAY<br>AND TIME         | ENTRER JOUR ET<br>HEURE DE<br>DESACTIVATION   | INTRODURRE<br>GIORNO E ORA DI<br>DISATTIVAZ    | INTRODUZCA<br>DIA Y HORA DE<br>DESACTIVACION       |
| OLD ROUTE PLAN: x<br>ENTER NEW PLAN:          | ACHEMINEMENT<br>ANT.: x ENTRER<br>NOUVEAU:    | INSTRADAMENTO<br>PREC: x INTROD IL<br>NUOVO:   | PLAN RUTAS<br>ANT: x<br>INTRODUZCA<br>EL NUEVO:    |
| OLD ROUTE PLAN: x<br>NEW PLAN: y              | ACHEMINEMENT<br>ANT.: x NOUVEAU<br>PLAN: y    | INSTRADAMENTO<br>PREC: x NUOVO<br>PIANO: y     | PLAN RUTAS<br>ANT: x NUEVO<br>PLAN: y              |
| ROUTE PLAN: x FOR<br>yyy ACT-TIME: zz:zz      | ACHEM.: x POUR yyy<br>ACT-HEURE: zz:zz        | INSTRADAMENTO: x<br>PER yyy ATTIV<br>ORE:zz:zz | PLAN RUTAS: x<br>PARA yyy<br>HORA-ACT:<br>zz:zz    |
| ROUTE PLAN: x FOR<br>yyy DEACT-TIME:<br>zz:zz | ACHEM.: x POUR yyy<br>DESACT-HEURE:<br>zz:zz  | INSTRADAM.: x PER<br>yyy DISATTIV<br>ORE:zz:zz | PLAN RUTAS: x<br>PARA yyy<br>HORA-DESACT:<br>zz:zz |

**Table 4-31. Time-of-Day Routing Days of the Week<sup>1</sup>**

---

| English | French | Italian | Spanish |
|---------|--------|---------|---------|
| Mon     | LUN    | Lun     | LUN     |
| Tue     | MAR    | Mar     | MAR     |
| Wed     | MER    | Mer     | MIE     |
| Thu     | JEU    | Gio     | JUE     |
| Fri     | VEN    | Ven     | VIE     |
| Sat     | SAM    | Sab     | SAB     |
| Sun     | DIM    | Dom     | DOM     |

---

1. To enter the day of the week, the user dials 1 for Sunday, 2 for Monday, and so on.

---

## Considerations

---

Users of a 32-character display set cannot choose a display language. These sets (in particular, the hybrid MERLIN 7315H and 7317H sets) default to English.

## Interactions

---

None

## Administration without Hardware

---

Administration without Hardware (AWOH) allows you to perform station translations without specifying terminal port locations. These stations are called AWOH stations until they are associated with a terminal port.

### How to administer AWOH

---

#### Required forms

| Form              | Field                                       | Page                  |
|-------------------|---|-----------------------|
| Attendant Console | ■ Port                                      | <a href="#">5-35</a>  |
| Data Modules      | ■ Port<br>or<br>■ Board                     | <a href="#">6-226</a> |
| Hunt Group        | ■ Calls Warning Port<br>■ Time Warning Port | <a href="#">5-158</a> |
| Station           | ■ Port                                      | <a href="#">6-28</a>  |

### Detailed description

---

AWOH streamlines system initializations, major additions, and rearrangements or changes by allowing you to enter station translations without assigning ports. It also allows voice-terminal users, data-terminal users, and technicians to disassociate station translations from the current terminal port and then associate them with another terminal port. Terminal users perform these station disassociations and associations with Personal Station Access (PSA) while technicians use Terminal Translation Initialization (TTI) to perform these tasks.

Because AWOH stations do not have physical terminals associated with them, they cannot generate alarms or errors. In addition, their lamps or alerting tones cannot be affected by the system or other terminals. Likewise, pressing buttons on a physical terminal that is not associated with a station has no affect.

AWOH works the same as administration with hardware translation. For example, when terminals are moved, user-activated features such as Call Forwarding and Send All Calls remain active. Any action that changes the station's status or lamps is reflected once the terminal becomes associated with a terminal.

An AWOH station is considered disassociated when no hardware ports are assigned to the station. To indicate that there is not yet any hardware associated with a station you are administering, set the `Port` fields to `X`. When the port is assigned later, the AWOH station is considered associated.



AWOH allows you to:

- Administer station forms without specifying a port location
- Use phantom extensions to provide call coverage (including AUDIX coverage) for users who do not have stations physically located on the switch
- Use phantom extensions for ACD Dialed Number Identification Service (DNIS). This allows you to administer a phantom extension on the switch for each call type that needs to be identified to ACD agents. Either the phantom extension is Call Forwarded (via Console Permissions) to an ACD split, or its coverage path is defined to include the ACD split. The `Name` field for the phantom extension identifies the service that the caller wants, allowing the agent to properly address the caller.
- Store duplicated stations without specifying a port
- Administer phantom stations so that, with Terminal Translation Initialization (TTI), you can connect to the system by dialing a special digit sequence from the station. Station users use PSA to assign terminals to AWOH stations.

## Interactions

### Voice-terminal interactions

- Abbreviated Dialing

Abbreviated Dialing calls to AWOH stations behave as normally dialed station-to-station calls to AWOH extensions. A station with abbreviated dialing that becomes disassociated retains its list entries.
- Automatic Call Distribution

An AWOH station cannot be logged into an ACD split. The station cannot be logged into an ACD split via a bridged appearance, even if it has a bridged appearance on another station.
- Automatic Callback

Attempting automatic callback to any AWOH station sends reorder tone to the caller, indicating that Automatic Callback cannot be activated.
- Bridged Call Appearance

A normal station (not an AWOH station) that has an appearance of an AWOH station can originate a call on the bridged call appearance. Calls can be made to an AWOH station and answered at any of its bridged appearances on other stations. An AWOH station may contain bridged call appearances, but calls cannot be placed to them.
- Busy Verification of Terminals and Trunks

An AWOH station appears to be out of service when busy verification of terminals and trunks is attempted on that station.

## 4 Basic Features

### *Administration without Hardware*

Page 4-42

- Call Coverage

AWOH stations interact with Call Coverage as if all call appearances are busy. A disassociated station can have Call Coverage active.
- Call Forward

AWOH stations can have Call Forward active while in a disassociated state. When the station is associated, Call Forward remains active.
- Call Park

A call to an AWOH station can be parked only if the primary extension of that station has a bridged call appearance on a normal station (not an AWOH station). A call parked from a bridged call appearance is parked on the primary extension.
- Call Waiting Termination

Call Waiting Termination can be administered on a single-line AWOH station, but the caller receives a busy signal if the station is disassociated.
- Conference

No conferencing of AWOH stations is possible.
- Customer-Provided Equipment (CPE) Alarm

If a CPE alarm is activated for an AWOH station, no equipment is available to ring or light.
- Data Buttons

Data buttons are not lit for AWOH data modules.
- Display

The display for calls originating or terminating from a bridged call appearance for AWOH stations, is the same as for normal bridging.
- Facility Busy Indication

Normal stations can have busy indicator lights for AWOH stations, but the lights are not lit. This is because Facility Busy Indication indicates if a station is off-hook or on-hook, even if you have assigned bridged appearances. A station without hardware translation is always on-hook.

Busy indicator lights can be administered on AWOH stations. When a port is assigned to the station so it is no longer AWOH, busy indicator lights function normally.
- Incoming Destination

If the incoming destination is an AWOH station, the caller hears ringback tone from the central office. Incoming Destination calls are routed based on features active for the station, such as Call Forward and Call Coverage.

## 4 Basic Features

### Administration without Hardware

Page 4-43

- ISDN-BRI voice terminals

If TTI is enabled, you cannot use the SAT to enter **X** in the `Port` field of a BRI voice terminal that is already connected to the switch. Instead, you must dial the TTI disassociate code from the voice terminal. See [“Terminal Translation Initialization” on page 4-583](#) for more information.

- Leave Word Calling

An AWOH station can be left a LWC message.

- Manual Message Waiting

When Manual Message Waiting is activated toward an AWOH station, there is no terminal on which to light the message waiting lamp. However, once the AWOH station is associated with a port or terminal, the message waiting lamp does light.

- Manual Signaling

Manual Signaling to an AWOH station does nothing, since there is no terminal to signal. However, the originator of the manual signal cannot tell that the station is an AWOH station and does not know that the signal is not received.

- Personal Central Office Line

AWOH stations can be administered with PCOL. If a call terminates at an AWOH station with no coverage, the caller receives ringback (no answer). Otherwise, the call routes to coverage.

- Priority Calling

A priority call terminating to an AWOH station hears a busy signal.

- Send All Calls

Send All Calls remains active on AWOH stations.

- Station Hunting

An AWOH station can be in a hunt chain.

- Station-to-Station Call

A call that terminates on an AWOH station is treated like a call to a station with all call appearances busy.

- Transfer

An attempt to transfer to an AWOH station has the same result as an attempt to a busy station would.

## Attendant interactions

- Attendant Group

If all attendants of a group are using AWOH consoles, internal callers receive ringback tone indefinitely. Attendant AWOH consoles behave the same as AWOH stations in group interactions.

## 4 Basic Features

### Administration without Hardware

Page 4-44

- Emergency Access to Attendant

If Emergency Access to the Attendant is activated while all attendants are using AWOH stations, and there is no backup extension or the backup extension is also AWOH, the originating party receives a busy signal.

- Interposition Calling (Attendant to Attendant)

Calls to individual attendants with AWOH stations receive intercept.

- Night Station Service

If an attendant activates Night Station Service, response to the caller depends on the administration of the endpoint. For instance, if the endpoint is a AWOH station, the caller hears a busy signal.

- World Class Attendant

- Attendant Override

If an attendant activates Attendant Override (and therefore bypasses coverage), the attendant hears a busy signal for calls to AWOH stations.

- Attendant Serial Calling

Attempting to extend a call to an AWOH station causes busy signal.

## Data-terminal interactions

- Administered Connections

Endpoints for ACs can be AWOH stations.

- Data Call Setup

- Data Terminal Dialing – A keyboard-dialed call that terminates to a data-endpoint AWOH station causes a BUSY message on the screen, indicating that the terminal is in use, out of service, or AWOH.

- Voice Terminal Dialing – See [“Station-to-Station Call” on page 4-43.](#)

- Hunt-Group (UCD/DDC)

See [“Call Coverage” on page 4-42.](#)

- Incoming Destination

See [“Incoming Destination” on page 4-42.](#)

- Terminal-to-Data Module Call

If a data endpoint is an AWOH station, either BUSY appears on the screen or a busy signal results, depending on the originating hardware. See [“Station-to-Station Call” on page 4-43.](#)

## Association and disassociation interactions

This refers to whether a voice terminal has been assigned a port location. Some of these functions are limited to multibutton sets.

- Attendant

Because the attendant is a central focus for incoming calls, it is advisable to have the attendant in Position Busy mode to route incoming calls. Attendant Priority Queuing ensures that individual attendant access and interposition calling are not reclassified and directed to the attendant group. These calls queue for the attendant and prevent the attendant from disassociating. Any calls queued, held, or seen as active for the attendant prevent the individual attendant from attempting to disassociate while in Position Available mode.

- Attendant Night Service

A night service station cannot be removed while in night service. To remove an endpoint AWOH station while night service is active, See [“Night Station Service” on page 4-44.](#)

- Attendant Release Loop Operation

Calls that are held with the release loop operation by the attendant are reclassified as attendant group calls if the attendant disassociates before the attendant timed-reminder interval expires.

- Automatic Callback

If a station becomes disassociated while a normal station has automatic callback active for the disassociated station, the normal station's automatic callback light turns off and callback sequence is broken.

- Bridged Call Appearance

If a station has a bridged call appearance of an off-hook station, the first station can disassociate at any time and not disrupt a call in progress on the bridge.

If a station with a bridged call appearance associates itself while the extension for the bridged appearance is on a call, the associating station can join the call.

Disassociation cannot be performed from a bridged call appearance. Disassociation (TTI) must be performed from the port on which the station resides.

- Call Coverage

If an AWOH station disassociates while Send-All-Calls or Go-to-Coverage is active, these features remain active.

- Call Coverage Answer Group

If any AWOH station is inserted into translation via TTI or station administration, that station cannot join current calls to the call-coverage answer group. The station can join subsequent calls.

## 4 Basic Features

### *Administration without Hardware*

Page 4-46

- Call Forward

A station can disassociate while Call Forward is active. If a Call Forward destination disassociates, Call Forwarding to that extension remains active.
- Call Park

If a line appearance is available, a station may disassociate while a call to that station is parked, and retrieve the call from another station.
- Call Pickup

If a line appearance is available, a member of a Call Pickup group may disassociate at any time.

If a call is ongoing to any extension in the group, any member of the group can disassociate or associate. That member does not join the group for the ongoing call, but is available for subsequent calls.
- CPE Alarm

If a station that has been administered with a CPE alarm becomes associated with a port while an alarm is active, the station receives the alarm once it is associated.
- Hunt Group UCD/DDC

If any AWOH station endpoint is inserted into translation via TTI or station administration, that station cannot join calls to the hunt group. The station can join subsequent calls.
- Hold

A station user may place a call on hold, disassociate, associate and retrieve the held call.
- Intercom Group — Auto/Dial

See [“Station-to-Station Call” on page 4-46.](#)
- Message Light

Messages need not be deleted before disassociation. If a station receives messages while it is disassociated, when the station receives hardware translation, the message light updates.
- Send All Calls

Send All Calls remains active when a station disassociates.
- Station-to-Station Call

Disassociation is disallowed while a call is in progress.
- Terminating Extension Group

If any AWOH station is inserted into translation via TTI or station administration, that station cannot join current calls to the terminating extension group. The station can join subsequent calls.

## 4 Basic Features

### Administration without Hardware

Page 4-47

- Transfer

After a connection has been made from first to third party, the second party who performed the transfer can disassociate. Parties one and three are treated as a station-to-station call.

- Trunk Group Night Service

If the night service destination is a station, disassociation operates the same as disassociation for stations. See [“Station-to-Station Call” on page 4-46](#). If the night service destination is an attendant, disassociation operates the same as disassociation for attendants. See [“Attendant” on page 4-45](#).

## World Class Attendant interactions

- Attendant Return Call

If the attendant is disassociated upon return from a call that has been extended to a station, the call is reclassified as an attendant group call and routes to the group.

- Serial Calling

In a serial call, the attendant is not in a busy state after releasing a call, and can disassociate. If the attendant is disassociated upon return from a call that has been extended to a station, the call is reclassified as an attendant group call and routes to the group.

## Data modules

Data modules can be associated/disassociated by:

- Data-terminal dialing
- Voice-terminal dialing
- Other devices including using a default set type to associate, and then removing the default set type and replacing it with the proper data endpoint

Because DTDMs reside on some station types, the port is automatically inherited from the host station. The DTDM receives its port identification when the station associates/disassociates.

- Administered Connections

If a connection is administered without hardware translation, the system attempts to establish a connection only when both endpoints are associated with hardware translation.

Administered connections can disassociate by changing the port for the data module to an X, either by administration or via TTI.

**4 Basic Features**

*Administration without Hardware*

*Page 4-48*

- Hunt Group (UCD/DDC)  
See [“Call Coverage” on page 4-42.](#)
- Terminal-to-Data Module Call  
See [“Station-to-Station Call” on page 4-43.](#)
- Transfer  
See [“Transfer” on page 4-43.](#)



## Alphanumeric Dialing

---

Alphanumeric Dialing enhances data-terminal dialing by allowing users to place data calls by entering an alphanumeric name rather than a long string of numbers.

### How to administer Alphanumeric Dialing

---

#### Required forms

---

| Form                       | Field           | Page                 |
|----------------------------|-----------------|----------------------|
| Alphanumeric Dialing Table | ■ Alpha-name    | <a href="#">5-23</a> |
|                            | ■ Mapped String |                      |

---

### Detailed description

---

Alphanumeric Dialing allows a user to place a data call using Data Call Setup and an alphanumeric string or alpha-name for the call-destination address. For example, a user could type 9+1-800-telefon instead of 9+1-800-835-3366 to make a call. Users need to remember only the alpha-name of the far-end terminating point.

Alphanumeric Dialing allows you to change a mapped string (digit-dialing address) without having to inform all users of a changed dial address. Users dial the alpha name.

When a user enters an alphanumeric name, the system converts the name to a sequence of digits according to an alphanumeric-dialing table. If the entered name is not found in the table, the system denies the call attempt and the user receives either an `Invalid Address` message (DCP) or a `Wrong Address` message (ISDN-BRI).

Because data terminals access the switch via DCP or ISDN-BRI data modules, dialing procedures vary:

- For DCP, at the `DIAL:` prompt users type the alphanumeric name and press `Return`.
- For ISDN-BRI, at the `CMD:` prompt users type `d`, a space, and the alphanumeric name, and press `Return`.

## **Considerations**

---

- Alphanumeric dialing does not apply to endpoints with Hayes modems.
- More than one alphanumeric name can refer to the same digit string.

## **Interactions**

---

None

## Alternate Operations Support System Alarm Number

---

Alternate Operations Support System Alarm (OSSA) Number allows you to establish a second number for the switch to call when an alarmable event occurs. This feature is useful to alert a second support organization, such as INADS or OneVision™.

This feature interacts with external trouble tracking and maintenance systems such as:

- INADS
- OneVision™ Network Management Solutions
- PSI (Expert System)
- Trouble Tracker
- Other tools that parse the alarm log entries

### How to administer Alternate OSSA Number

---

#### Required Forms

| Form                                  | Field                              | Page                  |
|---------------------------------------|------------------------------------|-----------------------|
| Maintenance-Related System Parameters | ■ Second OSS Telephone Number      | <a href="#">5-212</a> |
|                                       | ■ Alarm Origination to OSS Numbers |                       |

### Considerations

---

- When the switch processor element (SPE) is down, DEFINITY ECS sends notification and restart history to the first OSS number only. The second OSSA number does not affect attendant console and maintenance board lamp status.
- You can administer the system to have the switch call both numbers in the event of an alarm. If the first number acknowledges the alarm so that the alarm is no longer active, the alarm never reaches the second number.

### Interactions

---

None

## Answer Detection

---

For purposes of call-detail recording, it is important to know when the called party answers a call. DEFINITY ECS provides three ways to determine whether the far end has answered an outgoing call.

- Call Classification — A call-classifier board detects tones and voice-frequency signals on the line and determines whether a call has been answered. This method is fairly accurate. Special Information Tones (SIT) are not detected as answer by the call classifier.
- Network Answer Supervision — The central office (CO) sends back a signal to indicate that the far end has answered. If a call has traveled over a private network before reaching the CO, the signal is transmitted back over the private network to the originating system. This method is extremely accurate, but is not available over most loop-start trunks (for example, CO, FX and WATS trunks in the US).
- Answer Supervision by Timeout — You set a timer for each trunk group. If the caller is off-hook when the timer expires, the system assumes that the call has been answered. This is the least accurate method. Calls that are shorter than the timer duration do not generate call records, and calls that ring for a long time produce call records whether they are answered or not. True answer supervision does not override answer supervision by timeout.

### How to administer Answer Detection

---

#### Required forms for Call Classification

| Form  | Field                                   | Page                  |
|---|---|-----------------------|
| System Parameters Customer-Options                                | ■ Answer Supervision by Call Classifier | <a href="#">5-277</a> |
| System Parameters OCM Call Classification (outside US and Canada) | ■ All                                   | <a href="#">5-289</a> |

#### Required forms for Answer Supervision

| Form         | Field                        | Page                  |
|--------------|------------------------------|-----------------------|
| Trunk Groups | ■ Receive Answer Supervision | <a href="#">7-115</a> |

### Required forms for Answer Supervision by Timeout

---

| Form         | Field                        | Page                  |
|--------------|------------------------------|-----------------------|
| Trunk Groups | ■ Answer Supervision Timeout | <a href="#">7-115</a> |

### Considerations

---

- Call Classification does not always detect all types of tones accurately. For a normal answered call, the call is usually correctly classified as answer. However, some calls may be incorrectly classified as fast busy when they are actually answer.
- Miscellaneous tones, such as confirmation tones, may be classified as answer. In addition, loud background noise may activate Answer Detection, causing a call to be classified as answer even if the call is not connected.
- If Call Classification incorrectly classifies a call as answered, the system still generates a call record. If Call Classification incorrectly classifies a call as answered, and the call is subsequently answered, the call duration reported by CDR includes the time between the incorrect call classification and the actual far-end answer, and the remaining duration of the call.

### Interactions

---

- Call Detail Recording  
Answer Detection provides more accurate call records where tone detection is possible and Network Answer Supervision is not received.
- Call Prompting  
Answer Detection competes with Call Prompting for ports on the call classifier circuit pack.
- CallVisor ASAI  
Answer Detection competes with CallVisor ASAI switch-classified calls for ports on the call classifier circuit pack. Answer Detection triggers reporting of a connect event to ASAI.

## Attendant Auto-Manual Splitting

---

Attendant Auto-Manual Splitting allows the attendant to announce a call or consult privately with the called party without being heard by the calling party on the call. Attendant Auto-Manual Splitting provides for splitting the calling party away so the attendant can confidentially determine if the called party can accept the call.

### How to administer Attendant Auto-Manual Splitting

---

#### Required forms

---

| Form              | Field  | Page                 |
|-------------------|--|----------------------|
| Attendant Console | <ul style="list-style-type: none"><li>■ Feature Button Assignments<ul style="list-style-type: none"><li>— split</li><li>— dont-split</li></ul></li></ul> | <a href="#">5-35</a> |

---

#### Detailed description

---

This feature activates automatically when the attendant, active on a call, presses any of the following:

- The START button
- A Hundreds Select button
- And a Direct Extension Selection button (if provided)
- A Trunk Group Select button

#### Interactions

---

None

## Attendant Backup Alerting

The Attendant Backup Alerting feature allows other system users to pick up attendant calls when the attendant is unable to do so.

### How to administer Attendant Backup Alerting

#### Required Forms

| Form                      | Field                        | Page                  |
|---------------------------|------------------------------|-----------------------|
| Console-Parameters        | ■ Backup Alerting            | <a href="#">5-86</a>  |
|                           | ■ Calls in Queue Warning     |                       |
|                           | ■ Time in Queue Warning      |                       |
| Class of Service          | ■ Client Room                | <a href="#">5-81</a>  |
| Station                   | ■ Feature Button Assignments | <a href="#">6-14</a>  |
|                           | — atd-qcalls                 |                       |
| Feature Access Code (FAC) | ■ Trunk Answer Any Station   | <a href="#">5-113</a> |

### Detailed description

This feature provides both audible and visual alerting to backup stations when the attendant queue reaches its queue warning level. When the queue drops below the queue warning level, alerting stops.

Audible alerting also occurs when the attendant console is in night mode, regardless of the attendant queue size.

### Considerations

- Backup-station users must meet the following criteria to answer alerting calls in the attendant queue by dialing the FAC of Trunk Answer Any Station (TAAS).
  - Be at a multiappearance voice terminal
  - Have the atd-qcall feature button assigned to the station
  - Not have client-room COS. (COS set to no); otherwise, the user receives intercept treatment when trying to use the Attendant Backup Alerting feature
- The atd-qcall feature button provides the visual alerting for this feature. When this button is dark (idle state), there are no calls in the attendant queue. When the button shows a steady light (busy state), there are calls in the attendant queue. When button shows a flashing light (warning

state), the number of calls in the attendant queue exceeds the queue warning. The backup-station user also hears an alerting signal every 10 seconds.

- When the attendant console is in daymode and the Attendant Backup Alerting feature is disabled, visual alerting is as described above. However, no audible alerting signal applies to the backup stations and station users cannot answer attendant calls by dialing the TAAS FAC.

## Interactions

---

- Ringer Cutoff

Activating the Ringer Cutoff feature disables the audible alerting signal. If a backup station has Ringer Cutoff activated, the system audibly alerts the station only when the attendant queue exceeds the queue warning level.

If Ringer Cutoff is not activated, the system audibly alerts the backup station every 10 seconds until the attendant queue falls below the queue warning level.

- TAAS

If the system is in night mode and a TAAS port is not assigned, the attendant can answer queued calls exceeding the queue warning level only by dialing the TAAS FAC.

- Tenant Partitioning

You cannot use Attendant Backup Alerting if `Tenant Partitioning` is enabled on the System Parameters Customer-Options form.



## Attendant Call Waiting

---

Attendant Call Waiting allows an attendant-originated or -extended call to a busy single-line voice terminal to wait at the called terminal. The attendant is free to handle other calls.

### How to administer Attendant Call Waiting

---

#### Required Forms

---

| Form                              | Field  | Page                  |
|-----------------------------------|--|-----------------------|
| Station (Single-Line)             | ■ Att. Call Waiting Indication<br>— att. originating calls | <a href="#">6-28</a>  |
| Feature-Related System Parameters | ■ Attendant Originated Calls                               | <a href="#">5-123</a> |

---

### Detailed description

---

The attendant activates Attendant Call Waiting for a single-line station whenever he or she originates or extends a call to a busy single-line voice terminal. The attendant hears a ringback tone; the busy voice-terminal user hears a single-call waiting tone. The calling voice-terminal user does not hear the tone. You can administer the number of bursts (1, 2, or 3) in the `Attendant Originated Calls` field on the Feature-Related System Parameters form. The default is 2.

When Attendant Call Waiting is activated, the attendant can cancel the call, release the call, or hold the call on the console. However, releasing an attendant-originated call results in dropping the call completely.

If the attendant activates Attendant Call Waiting, and the administered Return Call Time-Out or Timed Reminder on Hold interval expires without the call being answered, the call returns to the console. You administer these intervals on the Console Parameters form.

The attendant can place a call in progress at the voice terminal on hold. After answering the held call, the attendant uses the Hold feature to return to the held call or toggle back and forth between the two calls.

As an example of how to use Attendant Call Waiting, assume that extension 123, a single-line voice terminal, is busy. An attendant extends a call to extension 123 and hears the call waiting ringback tone indicating that Attendant Call Waiting is activated. The attendant can announce the call-waiting condition to the calling party. Alternatively, the attendant can cancel the call and ask the calling party to call again later. Finally, the attendant can release the call or place the call on hold at the console. The user at extension 123 hears a tone and knows a call is waiting. The user can then terminate the call in progress, or place the call in

progress on hold and answer the waiting call. If the waiting call is not answered before a preassigned time interval (Return Call Timeout or Timed Reminder on Hold), the call returns to the attendant.

Attendant Call Waiting, as covered above, also applies to satellite PBX stations via TGU/TGE trunks.

## Considerations

---

- Attendant Call Waiting applies only for calls to single-line voice terminals within the system. Only one call per voice terminal can wait at a time.

## Interactions

---

- Automatic Callback

Activating Automatic Callback at the called voice terminal denies Attendant Call Waiting.

- Call Coverage

Attendant Call Waiting calls redirect to coverage if the called voice terminal has Data Privacy or Data Restriction activated. If one of these conditions exists, and you assign call coverage to a voice terminal, and you activate Send All Calls or coverage criteria are met, the call redirects to coverage. The operation is as follows:

- The Coverage Don't Answer interval specifies how long a call remains directed to the called voice terminal before redirecting to coverage. This interval applies to both the Busy and Don't Answer criteria. Attendant Call Waiting if applicable on the call, is active for the duration of the Don't Answer interval only. At the end of this interval, the call redirects to coverage.
- If the Return Call Timeout (Timed Reminder) interval expires before the Don't Answer interval expires, the call does not go to coverage, but returns to an attendant console. If the Don't Answer interval expires first, the call redirects to coverage, but can still return to the console if a coverage point does not answer the call before the Return Call Timeout.
- If the `Station Hunting` field is assigned and the called station is busy, the call redirects to the Hunt To Station Assignment.
- If Send All Calls is active or if the redirection criterion is Cover All Calls, the call immediately redirects to coverage instead of waiting.
- An attendant can release from an extended call at any point during the call without affecting the preceding operations.

**4 Basic Features**

*Attendant Call Waiting*

*Page 4-59*

- **Data Privacy**  
Activating Data Privacy at the called voice terminal denies Attendant Call Waiting.
- **Data Restriction**  
Activating Data Restriction at the called voice terminal denies Attendant Call Waiting.
- **DDC and UCD**  
Calls to a DDC or UCD group do not wait. However, they can enter the group queue, if provided.
- **Loudspeaker Paging Access**  
Activating Loudspeaker Paging Access at the called voice terminal denies Attendant Call Waiting.
- **Music-on-Hold Access**  
The calling party hears music if the call is a trunk-transferred call administered to receive Music-on-Hold. Otherwise, the calling party hears ringing.
- **Recorded Telephone Dictation Access**  
Activating Recorded Telephone Dictation Access at the called voice terminal denies Attendant Call Waiting.

## Attendant Calling of Inward Restricted Stations

---

A voice terminal with a Class of Restriction (COR) that is inward restricted cannot receive public network, attendant-originated, or attendant-extended calls.

The Attendant Calling of Inward Restricted Stations feature allows you to override this restriction.

### How to administer Attendant Calling of Inward Restricted Stations

---

#### Required forms

---

| Form                 | Field                  | Page                 |
|----------------------|------------------------|----------------------|
| Class of Restriction | ■ Restriction Override | <a href="#">5-72</a> |

---

### Interactions

---

None

## Attendant Console

---

The attendant console is a digital call-handling station with push-button control used not only to answer incoming calls and place outgoing calls, but also to manage and monitor some system operations.

See System Capacity Limits in *DEFINITY ECS System Description Pocket Reference* to determine the number of attendant consoles that you can administer in each system configuration.

### How to administer Attendant Console

---

#### Required forms

---

| Form               | Field | Page                 |
|--------------------|-------|----------------------|
| Console-Parameters | ■ All | <a href="#">5-86</a> |
| Attendant Console  | ■ All | <a href="#">5-35</a> |

### Interactions

---

None

## Attendant Control of Trunk Group Access

---

Attendant Control of Trunk Group Access allows the attendant to control trunk groups, and prevents voice-terminal users from directly accessing a controlled trunk group.

### How to administer Attendant Control of Trunk Group Access

---

#### Required forms

| Form              | Field                        | Page                  |
|-------------------|------------------------------|-----------------------|
| Attendant Console | ■ Feature Button Assignments | <a href="#">5-35</a>  |
|                   | — act-tr-grp                 |                       |
|                   | — deact-tr-g                 |                       |
|                   | — local-tgs                  |                       |
|                   | — remote-tgs                 |                       |
| Trunk Group       | ■ Busy Threshold             | <a href="#">7-115</a> |
|                   | — Access                     | <a href="#">7-150</a> |
|                   | — APLT                       | <a href="#">7-156</a> |
|                   | — CO                         | <a href="#">7-168</a> |
|                   | — CPE                        | <a href="#">7-174</a> |
|                   | — DIOD                       | <a href="#">7-183</a> |
|                   | — DMI-BOS                    | <a href="#">7-188</a> |
|                   | — FX                         | <a href="#">7-193</a> |
|                   | — ISDN-PRI                   | <a href="#">7-219</a> |
|                   | — RLT                        | <a href="#">7-252</a> |
|                   | — Tandem                     | <a href="#">7-257</a> |
|                   | — Tie                        | <a href="#">7-262</a> |
|                   | — WATS                       | <a href="#">7-268</a> |

---

## Detailed description

Each attendant console has 12 designated Trunk Hundreds Select buttons usable with Attendant Control of Trunk Group Access. Each console may have up to 12 of its feature buttons administered as additional Trunk Hundreds Select buttons, for a total of 24 buttons. The attendant gains direct access to an outgoing trunk group by pressing the button assigned to that trunk group.

All Trunk Hundreds Select buttons (including any administered on the console's feature buttons) have a busy lamp that lights when all trunks in the associated trunk group are busy. If you administer one of the 2-lamp feature buttons on a basic console as a Trunk Hundreds Select button, use the bottom lamp as the busy lamp. Six of the designated buttons (basic console) or all 12 designated buttons (enhanced console) have two additional lamps used for Attendant Control of Trunk Group Access. The two additional lamps are:

- Warn (warning) lamp  
Lights when a pre-set number of trunks are busy in the associated trunk group
- Cont (control) lamp  
Lights when the attendant activates Attendant Control of Trunk Group Access for the associated trunk group

The attendant activates Attendant Control of Trunk Group Access by pressing a CONTACT (Control Activate) button followed by the desired Trunk Hundreds Select button. The Trunk Group Select button used must have a CONT (control) lamp. If a user attempts to access a controlled trunk group directly, the call automatically redirects to the attendant. If the attendant wants to allow the call to go through, the attendant can connect the user to the desired trunk group by pressing the associated Trunk Group Select button. The attendant then releases the call or holds the call on the console.

Activation of Attendant Control of Trunk Group Access does not affect calls already in the queue for that trunk group. For example, if an attendant activates Attendant Control of Trunk Group Access for a specific trunk group while a user is waiting in queue for an outside trunk in that trunk group, the call is not affected. The call remains in queue until an idle trunk becomes available, at which time the call connects to that idle trunk.

The attendant deactivates Attendant Control of Trunk Group Access by pressing the CONT DEACT (Control Deactivate) button followed by the desired Trunk Hundreds Select button. Attendant Control of Trunk Group Access activates and deactivates separately for each trunk group.

After an attendant presses a CONTACT or CONT DEACT button, the attendant can perform other operations before pressing the desired Trunk Hundreds Select button. This has no effect on the activation or deactivation of the feature. For example, if the attendant presses the CONTACT button and then has to answer

another call, the attendant presses the desired Trunk Hundreds Select button after answering the call, then activates, Attendant Control of Trunk Group Access for the associated trunk group.

## Considerations

---

- By activating Attendant Control of Trunk Group Access, the attendant obtains control of access to specific trunk groups. This allows the attendant to monitor the use of these trunk groups. Watching the lamps associated with the trunk groups, the attendant can determine if the number of busy trunks in a specific trunk group reaches a preset warning level and if all trunks in a specific trunk group are busy. The attendant can then handle other calls to these trunk groups accordingly.
- If Attendant Control of Trunk Group Access is activated and an attendant is not assigned, or if the attendant is later removed, calls to a controlled trunk group route to the attendant queue.

## Interactions

---

- Attendant Direct Trunk Group Selection  
Assign this feature with the Attendant Control of Trunk Group Access.
- Attendant Display  
When a call redirects to the console because Attendant Control of Trunk Group Access activates, the alphanumeric display identifies the calling party and shows that a call is attempting to access a controlled trunk group.
- Authorization Codes  
Authorization codes do not collect when a trunk group has an incoming destination set to the attendant.
- Automatic Route Selection and Automatic Alternate Routing (ARS/AAR)  
Activating Attendant Control of Trunk Group Access removes the controlled trunk groups from the ARS and AAR patterns. Deactivating the feature reinserts the groups into the patterns. ARS calls do not route to the attendant.
- QSIG  
QSIG trunks do not support Attendant Control of Trunk Group Access.
- Trunk Group Busy/Warning Indicators to Attendant  
This feature keeps the attendant informed of trunk-group status. Use this status to determine when to activate control.



**4 Basic Features**

*Attendant Control of Trunk Group Access*

*Page 4-65*

- **Uniform Dial Plan**

Activating Attendant Control of Trunk Group Access removes the controlled trunk groups from preferences. Deactivating the feature enables the UDP to access the trunk groups.

## Attendant Crisis Alert

---

Attendant Crisis Alert sends visual and audible alerting to attendant consoles when an emergency call (such as 911) is placed.

### How to administer Attendant Crisis Alert

---

#### Required Forms

| Form               | Field                       | Page                 |
|--------------------|-----------------------------|----------------------|
| ARS Digit Analysis | ■ call type                 | <a href="#">8-54</a> |
|                    | — alrt                      |                      |
| Attendant Console  | ■ Feature Button Assignment | <a href="#">5-35</a> |
|                    | — crss-alert                |                      |

Note that you can set up any access code for crisis alert. If this feature is installed and administered, a record is also printed on the journal/schedule printer.

### Detailed description

---

Attendant Crisis Alert indicates from where an emergency call is made. This information allows the attendant to direct emergency-service response to the caller.

Audible alerting sounds like an ambulance siren. Visual alerting consists of flashing of the crss-alert button lamp and display of the caller name and extension.

When crisis alerting is active at the attendant console, the console is in position-busy mode so that no other incoming calls interfere with the emergency call. The console can still originate calls. The attendant must press the position-busy button to unbusy the console and the crss-alert button to deactivate audible and visual alerting.

#### How to use Attendant Crisis Alert

| Action          | Lamp     | Ringer | Display    |
|-----------------|----------|--------|------------|
| Emergency alert | Flashing | Siren  | Caller Ext |
| First push      | Flashing | None   | Caller Ext |
| Second push     | Steady   | None   | Caller Ext |
| Third push      | Off      | None   | Cleared    |

## Report

The Emergency Access Calls Report is used to track emergency calls by extension, event, type of call, and time of day. This log prints in the system journal printer with name, time and event code (attendant crisis alert).

To display the Emergency Access Calls Report, enter:

```
list emergency [print/schedule]
```

## Considerations

---

- Only one crss-alert button is allowed per attendant console.
- Consoles without a crss-alert button do not receive emergency notification.

## Interactions

---

- Tenant Partitioning  
If tenant partitioning is active, only attendants within each partition can receive emergency notification from callers within the partition.

## Attendant Direct Extension Selection with Busy Lamp Field

---

Attendant Direct Extension Selection with Busy Lamp Field allows the attendant to track extension status (idle or busy) and to place or extend calls to extension numbers assigned to the system without having to dial the extension number.

### How to administer Attendant Direct Extension Selection with Busy Lamp Field

---

#### Required forms

---

| Form              | Field                                     | Page                 |
|-------------------|---|----------------------|
| Attendant Console | Hundreds Select Button Assignments (1-20) | <a href="#">5-35</a> |

### Detailed description

---

#### NOTE:

An associated DXS lamp for a vector directory number (VDN) is always dark. The DXS button may be used to place a call to a VDN.

The attendant can use this feature in two ways:

- Using standard Direct Extension Selection (DXS) tracking. If your attendant console has one or more Hundreds Select buttons, press a Hundreds Select button and a DXS button to access a station.
- Using Enhanced DXS tracking when:
  - Your attendant console does not use Hundreds Select buttons.
  - Your attendant console uses Hundreds Select buttons, but you have one or more hundreds groups not administered by a Hundreds Select button.

In either case, you can use a Group Select button and dial the first two or three digits of the station and then use the DXS button to access the station. See the Enhanced DXS Tracking subsection below.

In both cases (using a Hundreds Select button or the Group Select button), when the system tracks a group of extensions, the attendant can place or extend subsequent calls to extensions in that group by pressing the DXS button, without having to reselect the group. Both of these capabilities eliminate the need to dial extensions.

Extensions may be voice-terminal extensions, hunt-group extensions, off-switch extensions (such as UDP extensions), or non voice-terminal extensions.

## 4 Basic Features

### *Attendant Direct Extension Selection with Busy Lamp Field*

Page 4-69

Whichever method you use to access and track DXS extensions, view the group of extensions currently being tracked using a Group Display feature button. This button on the console indicates the range of extensions tracked by the selector console.

## Standard DXS Tracking

The basic selector console has 8 Hundreds Select buttons and 100 DXS buttons. The enhanced selector console has 20 Hundreds Select buttons and 100 DXS buttons. You can assign 12 additional Hundreds Select buttons to feature buttons on the attendant console. However, if using these feature buttons, the total number of Hundreds Select buttons per attendant (including both the attendant-console feature buttons and the selector-console buttons) cannot exceed 20. Label each Hundreds Select button with a different hundreds group number used in the system. For example, if a system uses 4-digit extensions, you could label the Hundreds Select buttons 2400, 2500, 2800, and so on. Likewise, you could label a 3-digit system 100, 200, 300, and so on. And you could label a 5-digit system 28400, 28500, 28600, and so on.

The 100 DXS buttons are labeled 00 to 99, and each button represents the last two digits of an extension. Each DXS button, combined with a Hundreds Select button, represents a unique extension. To place a call to an extension, the attendant presses the appropriate Hundreds Select button followed by the appropriate DXS button. For example, to call extension 4321, the attendant presses Hundreds Select button 4300 followed by DXS button 21.

A lamp associated with each Hundreds Select button indicates the selected hundreds group. A selected hundreds group remains selected until you press another Hundreds Select button. The associated lamp lights and remains lighted until you press another Hundreds Select button. Each DXS button also has an adjacent lamp, used to determine the idle/busy active status of the facility associated with the button. When a facility is busy/active, the lamp at the associated DXS button lights. When the associated facility is idle, the lamp is dark. For multifunction voice terminals with a speakerphone or the CallMaster voice terminal, the facility is busy when a user is active on a call appearance (talking or originating a call) and idle when all call appearances are idle, ringing, or held. For other voice terminals, the facility is busy when the station is off-hook and idle when the station is on-hook.

Although the Group Select and DXS buttons may be used to dial any extension, the Busy Lamp field reflects the status of on-switch resources.

After the attendant presses the Hundreds Select button, if the lamp adjacent to the desired DXS button is lighted to indicate busy status, the attendant can sometimes still place or extend the call or can activate Attendant Call Waiting for a single-line voice terminal. A multiappearance voice terminal user receives the call on an idle appearance. If no idle appearance becomes available, the call routes to coverage, or receives busy tone when coverage is not available.

## Enhanced DXS Tracking

Enhanced DXS Tracking can help you if you have more than 100 stations, but you use a console that does not have Hundreds Select buttons administered. It can help if you have more stations than you do Hundreds Select buttons (and thus have hundreds groups that are administered with Hundreds Select buttons). This means that, if you have the basic selector console but have more than 800 stations, or if you have the enhanced selector console but have more than 2000 stations, you can still use the selector console to track the extra unadministered stations and extend calls to them.

To do this, you must have a Group Select feature button. This button allows you to track and extend calls to stations that do not have Hundreds Select buttons administered. This button is useful if the attendant prefers to use the dial pad to access a group of stations rather than press a Hundreds Select button.

The Group Select feature button works for extensions of 3-, 4-, or 5-digits (extensions 100 through 99999).

### NOTE:

Enhanced DXS Tracking supports only stations that reside on the same PBX as the attendant console. The attendant can extend calls to another DCS switch via Enhanced DXS Tracking, but the DXS console does not show busy or idle status of stations on the other switch.

To view extension status or extend calls using the Group Select button, press the Group Select button, dial the 2- or 3-digit prefix of the extension you want, and press the # button. The lamps on the selector console light for all extensions in that group that are busy. For example, to view the status of extension 84463, press the Group Select button, dial **844**, and press the pound # button. The lamps on the selector console indicate busy extensions for the group 84400-84499. You can now handle the call as normal. If you want to extend the call to a station in the group, press the DXS button for that station.

If you press any Hundreds Select button on the DXS module and the console currently is in the Group Select mode, the console reverts to normal mode.

## The Group Display Button

You can administer a Group Display button to help you track extension status. The button enables you to see which group of extensions the system currently tracks. Press this button and the system indicates on the display panel the range of extensions currently tracked by the selector console.

### NOTE:

Administer the Group Display button for either the feature area or the display area of the console.

## 4 Basic Features

### *Attendant Direct Extension Selection with Busy Lamp Field*

Page 4-71

If you select this button, the system identifies the digits associated with a Hundreds Select button — unless it finds no Hundreds Select button is lit, in which case it identifies the digits last entered with the Group Select button. The system continues to track the selected group of extensions until you either press a Hundreds Select button, or press the Group Select feature button and dial the prefix for the new extension group and the # button. In either case, the system tracks the new group of stations.

## Considerations

---

- With the Attendant Direct Extension Selection with Busy Lamp Field, the attendant can place calls to 800 extensions using the basic selector console, 2000 extensions using the enhanced selector console or up to 99999 extensions using the Group Select feature button (extension numbers from 100 to 99999). If the desired hundreds group is being tracked with either a Hundreds Select button or the Group Select feature button, the attendant presses the desired DXS button to access a station.
- This feature provides the attendant with a visual indication of the idle/active status of the extension numbers assigned to the selected hundreds group. Up to 100 extensions can be monitored for idle or active status at a time.
- Enhanced DXS Tracking does not support extensions with fewer than three digits.
- Station tracking is possible only for the PBX on which the attendant resides.

## Interactions

---

- **Attendant Display**  
When the attendant uses the Attendant Direct Extension Selection with Busy Lamp Field, the alphanumeric display identifies the call through the Attendant Display.
- **Call Coverage**  
If Send All Calls is activated, or if the Call Coverage redirection criteria are met, then an extended call redirects to the coverage path.
- **Centralized Attendant Service**  
When the attendant uses a DXS button to make a CAS call, it takes a few seconds before the attendant hears ringback tone.

## Attendant Direct Trunk Group Selection

---

Attendant Direct Trunk Group Selection allows the attendant to access an idle outgoing trunk.

### How to administer Attendant Direct Trunk Group Selection

---

#### Required forms

---

| Form              | Field   | Page                 |
|-------------------|---|----------------------|
| Attendant Console | ■ DTGS Button Assignments (TAC) (1-12)<br>— local-tgs | <a href="#">5-35</a> |

---

#### Detailed description

---

You can use up to 12 designated Trunk Hundreds Select buttons on each console. In addition, you can administer up to 12 of the feature buttons as additional Trunk Hundreds Select buttons, for a total of 24 Trunk Hundreds Select buttons per console. Each button allows the attendant direct access to an outgoing select trunk group.

While an attendant is talking on a call, that call can be split away and a new call placed to the outgoing trunk specified by the trunk group select button. The attendant can then press Release to connect the split-away parties to the trunk's dial tone, or the attendant can dial the destination and press Release to connect the split-away party to the called party.

All Trunk Hundreds Select buttons (including any administered on the feature buttons) have a Busy lamp that lights when all trunks in the associated trunk group are busy. If you administer one of the 2-lamp feature buttons on a basic console as a Trunk Hundreds Select button, use the bottom lamp as the Busy lamp. Six of the designated buttons (basic console) or all 12 designated buttons (enhanced console) also have a Warn (warning) lamp and a CONT (control) lamp. The Warn lamp lights when a preset number of trunks in the associated trunk group are busy. The Cont lamp lights when the attendant activates Attendant Control of Trunk Group Access for the associated trunk group.

You can assign Loudspeaker Paging zones rather than trunk groups to Trunk Hundreds Select buttons. The Busy lamp then indicates the idle/busy status of the associated Loudspeaker Paging zone.



## **Considerations**

---

- Attendant Direct Trunk Group Selection eliminates the need for the attendant to memorize, or look up, and dial the trunk-access codes associated with frequently used trunk groups. A label associated with each Trunk Hundreds Select button identifies its destination or use — for example, Chicago, FX, or WATS. Pressing the button selects an idle trunk in the desired group.

## **Interactions**

---

- Attendant Control of Trunk Group Access  
If Attendant Control of Trunk Group Access is provided, this feature must also be provided.
- QSIG  
Attendant Direct Trunk Group Selection does not apply to QSIG trunks.

## Attendant Display

---

The Attendant Display feature shows call-related information on the alphanumeric display that helps the attendant operate the console more efficiently. It also shows personal-service and message information.

### How to administer Attendant Display

---

#### Required forms

---

| Form              | Field                        | Page                 |
|-------------------|------------------------------|----------------------|
| Attendant Console | ■ Feature Button Assignments | <a href="#">5-35</a> |
|                   | — call-disp                  |                      |
|                   | — type-disp                  |                      |
|                   | — cov-msg-rt                 |                      |
|                   | — date-time                  |                      |
|                   | — delete-msg                 |                      |
|                   | — timer                      |                      |
|                   | — inspect                    |                      |
|                   | — directory                  |                      |
|                   | — next                       |                      |
|                   | — normal                     |                      |
|                   | — stored-num                 |                      |
|                   | — class-rstr                 |                      |

---

### Detailed description

---

The system allows the attendant to select either American English (default), French, Italian, Spanish, or user-defined language displays. See [“Administrable Language Displays”](#) for more information.

Assign the following display modes to the eight buttons in the display area of the console, or to any programmable feature button on the console. The system also provides Normal and Test modes; the other modes are optional.

- Normal

Displays call-related information for the active call appearance. The alphanumeric display is in normal mode unless the attendant selects another mode. The display must be in normal mode to answer incoming calls.

- Inspect  
Displays call-related information for a call on hold or an unanswered call
- Stored Number  
Displays the number to a button administered through the Facility Busy Indication feature or the number assigned to an Abbreviated Dialing button.
- Date/Time  
Displays the current date and time of day
- Test  
Displays a test pattern representing each of the 40 characters. The lamp test switch on the console does not require an additional button assignment.
- Elapsed Time  
Displays elapsed time in hours, minutes, and seconds. Pressing the button starts or stops timing.
- Integrated Directory  
Turns off the touch-tone signals and allows use of the touch-tone buttons to key in the name of a system user. After a name is keyed in, the display shows that name and associated extension.
- Coverage Message Retrieval  
Retrieves and displays Leave Word Calling and Call Coverage messages for system users. Messages can be retrieved at any time. The attendant can be active on a call and still retrieve messages.

Assign three additional buttons to the console when assigning the Coverage Message Retrieval mode or the Integrated Directory model:

- Next Message  
Retrieves and displays the next message, displays NO MESSAGES, or displays END OF MESSAGES, (PUSH Next TO REPEAT) when in the Coverage Message Retrieval Mode. Displays the next name in the alphabetical listing when in the Integrated Directory mode. Assign this button when assigning the Retrieval button.
- Call Display  
Automatically returns the call requested by the currently displayed message or the currently displayed name and extension number. This button is optional.
- Delete  
Deletes the currently displayed message. Assign the Delete button when assigning the Retrieval mode button. This button is not used with Integrated Directory.

You can administer a Call Type button for the attendant console. When the attendant presses the Call Type button, the system displays the call type of the active call. The call type appears for one second and then the display returns to normal mode. The following are the three possible call types:

- Call Type 1: an outgoing public network call that receives answer supervision when the Answer Supervision Timer of the trunk group expires, even if the trunk is actually still ringing. An incoming call classifies as Type 1 when it is answered.
- Call Type 2: an incoming external public network call before it receives answer supervision or before the Answer Supervision Timer of the trunk group expires.
- Call Type 3: all other calls — all internal calls, conference calls, and tie trunk calls of any type.

## **Call-Related Information**

### **Call Appearance Identification**

The display labels the attendant call-appearance buttons alphabetically.

### **Calling Party Identification**

When a call is from a system user, the display shows the caller's name or a unique identification administered for the voice terminal used, along with the calling party's extension. When the call is from outside the system, the display shows the trunk identification, such as CHICAGO, and the trunk access code assigned to the trunk group used for the call.

When a call comes from an ISDN trunk group, additional information may be provided.

### **Called Party Identification**

On internal calls, the display shows the digits as dialed. After dialing is completed, the display shows the called party's name and extension. If no name is assigned, only the extension displays.

On outgoing calls, the display shows the digits as dialed or the name and trunk access code assigned to the trunk group being used. You can suppress the name of any trunk group.

When a call comes from an ISDN trunk group, additional information may be provided.

### Internal class of restriction

All system users have a class of restriction (COR) to define their calling privileges. The COR is a 2-digit number followed immediately by a hyphen and a 4-character identifier. Press a COR button to display a user's COR. COR identifiers are:

### Call Progress Feedback

**Table 4-32. Call Progress Feedback**

| Class of Restriction | Identifier              |
|----------------------|-------------------------|
| ORIG                 | Origination restriction |
| OTWD                 | Outward restriction     |
| TOLL                 | Toll restriction        |
| CODE                 | Code restriction        |
| NONE                 | No restriction          |

The system presents Call Progress Feedback including ringing, busy, and call waiting.

### Call Purpose

This refers to calls directed, redirected, or returning to the console. The English language call-purpose identifiers are:

**Table 4-33. Call Purpose**

| Identifier                                   | Purpose   |
|--|---|
| an – Attendant No Answer                     | Indicates that a redirected call went to another attendant because the attendant no answer and attendant alerting interval timers expired.                                    |
| co – Controlled Outward Restriction Call     | Indicates a redirected call from an internal user to the attendant. The voice terminal is administered for Controlled Outward Restriction and tried to make an outgoing call. |
| ct – Controlled Termination Restriction Call | Indicates a redirected call to the attendant. The voice terminal is administered for Controlled Termination Restriction and the calling party tried to call the terminal.     |

*Continued on next page*

**Table 4-33. Call Purpose — Continued**

| Identifier   | Purpose  |
|--|--|
| cs – Controlled Station-to-Station Restriction Call  | Indicates a redirected call from an internal user to the attendant. The voice terminal has Controlled Station-to-Station Restriction and tried to make a station-to-station call.  |
| da – DID Recall  | Indicates that the central office operation activated the DID recall feature when the switch disconnected first from an incoming DID call placed by the operator. The resulting call routes to the attendant group. DID Recall is used only in some countries. |
| hc – Held Call   | Indicates that a call held by the attendant is left on hold longer than the held call timeout value  |
| ic – Intercept Call  | Indicates a redirected incoming call to the attendant as a result of Intercept Treatment (defined attendant as default on System Parameter Features form).   |
| ip – Inter-Position Call   | Indicates an incoming call to the attendant's individual extension by another attendant. ip does not display at the terminating attendant console if permissions for the associated COS field are set to <b>n</b> .  |
| <p> <b>NOTE:</b><br/>“ip” does not display at the terminating attendant console if <code>Console Permissions</code> fields on the associated Class of Service are <b>n</b>.</p> |  |
| ld – DID LDN Call  | Indicates that an incoming call is a listed-directory-number (LDN) call on a DID trunk   |
| n – night service  | Indicates call routing to the attendant due to night service on a trunk group or hunt group  |
| na – no answer   | Indicates an unanswered incoming DID call for longer than the no answer timeout value  |
| p – Call Pickup  | Indicates that the attendant answered a call via the Call Pickup feature   |
| pc – Personal Call   | Indicates an incoming call to the attendant's individual extension, and not to the attendant group   |

*Continued on next page*

**Table 4-33. Call Purpose — Continued**

| Identifier          | Purpose  |
|---------------------|--|
| rt – Returned Call  | Indicates an unanswered attendant-extended call within the administered interval. The call returned to the console.    |
| qf – Queue Full     | Indicates redirection of a call to the attendant (or switch) because the emergency queue is full                       |
| rc – Recall Call    | Indicates that an internal user, active on a call held on the console, requests attendant assistance                   |
| sc – Serial Call    | Indicates a serial call  |
| tc – Trunk Control  | Indicates that an internal user tried to access an attendant-controlled trunk. The call was redirected to the console. |
| f – Call Forwarding | Indicates that an internal user has calls forwarded automatically to the attendant                                     |

### Call Coverage

When the Call Coverage feature is active and the attendant is a covering user, the following call-purpose identifiers display:

**Table 4-34.**

| Identifier                | Purpose  |
|---------------------------|--|
| s – Send All Calls        | Indicates the called party is temporarily sending all calls to coverage.   |
| d – Don't Answer or Cover | Indicates a called party sent a call to coverage, or party is not available. It also indicates that the called party has a temporary bridged appearance of the call. |
| b – Busy                  | Indicates the called party is active on a call, and the party has a temporary bridged appearance of the call.  |

*Continued on next page*

Table 4-34. — Continued

| Identifier       | Purpose   |
|------------------|---|
| B – Busy         | Indicates the called party is active on a call, and the party does not have a temporary bridged appearance of the call. All calls to single-line voice terminals that go to coverage display B. |
| c – Cover All    | Indicates the called party has all calls redirected to coverage.  |
| sc – Serial Call | Indicates an incoming call is a serial call.  |

### Sample displays

The attendant console has a 1-line 40-character alphanumeric display. Some typical displays follow:

Internal call originated by the attendant:

a=3602

then

a= TOM BROWN 3062

or

a= EXT 3602 3602

Outgoing trunk call originated by the attendant:

b=87843541

Where 8 is the trunk-access code and 784-3541 is the number dialed.

then

b= OUTSIDE CALL 8

or

b= WATS 101

Where 101 is the trunk-access code of the outgoing-trunk group.

Incoming-trunk call to the attendant:



4 Basic Features  
Attendant Display

Page 4-81

a= OUTSIDE CALL 102

Where 102 is the trunk-access code of the incoming-trunk group.

Conference call originated by the attendant:

b= CONFERENCE 4

Where 4 is the number of conferees, not including the attendant.

Internal call redirected to coverage:

b= EXT 3174 to EXT 3077 d

or

b= BOB SMITH to JOYCE THOMAS d

Where d indicates that Go to Cover activates by the calling party.

Incoming-trunk call redirected to coverage:

b= OUTSIDE CALL to DON SMITH s

Where s indicates that Send All Calls activates by the called party.

Coverage Message Retrieval:

IN PROGRESS

then

dial extension

MESSAGES FOR BETTY R. SIMS

then

JOE JONES 10/16 11:40a 2 CALL 3124

This display shows that Joe Jones called Betty R. Sims on October 16. The system stored the message at 11:40 a.m. Joe wants Betty to call his extension, 3124.

Integrated Directory mode:

CARTER, ANN 3408 3

This display shows the name and extension administered in the system. The 3 indicates that three buttons were pressed to reach this particular display.

## Considerations

---

- If the attendant group is administered for system-wide message retrieval, attendants can retrieve messages for all voice-terminal users. Permission to have coverage message retrieval can also be administered for the voice-terminal user. It is not possible for selected attendants to retrieve messages for selected voice-terminal users.
- The display must be in normal mode for the attendant to answer incoming calls.
- A call from the primary extension or a bridged call appearance of the primary extension displays as a call from the primary extension.

## Interactions

---

- Hospitality

With Hospitality Services administered, incoming trunk calls that return to the attendant unanswered after being extended by the attendant to a client room do not have the standard return call display. Rather, they show the client name and room number along with the rt Indicator. Client-room calls to the attendant that return to the attendant after being extended to a second client room display the client name and room number with a ex Reason Indicator. The ex Reason Indicator does not appear for any other type of call.

## Attendant Intrusion

---

Attendant Intrusion (Call Offer) allows an attendant to intrude on an existing call to offer a new call or message to the intruded party.

### How to administer Attendant Intrusion

---

#### Required forms

---

| Form              | Field                                       | Page                 |
|-------------------|---|----------------------|
| Attendant Console | ■ Feature Button Assignments<br>— intrusion | <a href="#">5-35</a> |

---

### Detailed description

---

- Upon the attendant's release from the intruded call, the source party shows as Call Waiting at the intruded party's analog voice terminal or is sent to an available line appearance on a digital voice terminal.



#### NOTE:

If there is already a call waiting call on the intruded party's terminal, the source party (split from the attendant) cannot wait at the intruded party's terminal because only one call can be call waiting at a time.

### Interactions

---

- Intrusion is denied in the following cases:
  - A station is on a conference call with administered maximum number of conferees
  - A call is established with Data Privacy activated
  - Establish a call with Data Restriction activated
  - A station is a forward-to point of another station
  - A station is busy talking to another attendant
- If a call is already call waiting for the intruded party, the source (split from attendant) party cannot wait for the intruded party using Call Waiting.
- The attendant display shows the character '1 wait' or '1 busy' if an intrusion is possible. Otherwise, the display shows 'wait' or 'busy'.
- The system provides Attendant Intrusion on remote stations via TGU/TGE trunks (Italy only).

## Attendant Override of Diversion Features

---

Attendant Override of Diversion Features allows an attendant to bypass call-diversion features invoked by and associated with a dialed extension. A diversion feature is any feature that, when activated, causes a call to alert at a point different from the dialed station. Send All Calls, Call Coverage, Call Forwarding All Calls, and Call Forwarding Busy/Don't Answer are diversion features.

### How to administer Attendant Override of Diversion Features

---

#### Required forms

---

| Form              | Field                                      | Page                 |
|-------------------|--|----------------------|
| Attendant Console | ■ Feature Button Assignments<br>— override | <a href="#">5-35</a> |

---

### End-user procedures

---

To invoke this feature, press the **VERRIDE** button. The **VERRIDE** lamp lights.

Press the **CANCEL**, **RELEASE**, or **FORCED RELEASE** button during dialing, to deactivate the feature. If you press the **VERRIDE** button again, the lamp goes out. The feature also deactivates when the call to the dialed extension terminates, or if a trunk-access code is dialed.

The system allows activation or deactivation of the override feature while dialing.

### Considerations

---

- Use this feature together with the Attendant Intrusion (Call Offer) feature to get an emergency or urgent call through to a station user.

### Interactions

---

- Centralized Attendant Services  
Centralized Attendant Services function as usual in conjunction with this feature.

## Attendant Priority Queue

---

Attendant Priority Queue allows attendants to answer calls by call category (for example, by trunk type). You can order calls as received into a category or by call type within the category.

### How to administer Attendant Priority Queue

---

#### Required forms

---

| Form                              | Field   | Page                  |
|-----------------------------------|---|-----------------------|
| Console Parameters                | ■ Queue Priorities  | <a href="#">5-86</a>  |
| Feature-Related System Parameters | ■ Reserved Slots for Attendant Priority Queue (page 3)      | <a href="#">5-123</a> |
| Language Translations             | ■ Miscellaneous-Features<br>— Page 5 - Number 46, Call Type | <a href="#">5-193</a> |

### Detailed description

---

Attendant Priority Queue handles incoming calls to an attendant when the call cannot be immediately terminated to an attendant. These calls are placed in the Attendant Priority Queue in order of priority queue level and timestamp within that level. The calling party hears ringback until an attendant answers the call.

### Priorities by Call Categories

You assign a priority queue level to each of the 12 incoming attendant call categories. Each category has a default level. You can reset the level for any category.

The attendant call categories are:

- Emergency Call to the Attendant Group — A call from a station user who dials the emergency access code (default is highest-priority level)
- Assistance Call to the Attendant Group — A call from a station user who dials the attendant-group access code, or from a station that has the Manual Originating Line Service feature activated
- Attendant Group Call over a CO/FX/WATS Trunk — An incoming trunk call to an attendant group (not including trunk calls returned to the attendant group after a timeout or deferred attendant recall)
- Attendant Group Call over a DID Trunk — As above except for a DID trunk

## 4 Basic Features

### Attendant Priority Queue

Page 4-86

- Attendant Group Call over a Tie Trunk — As above except for a tie trunk (dial-repeating or direct types)
- Redirected DID or Redirected ACD Call — A DID or ACD call that times out due to ring/no-answer, busy condition (if applicable), or Number Unobtainable and reroutes to the attendant group
- Redirected Call — A call assigned to one attendant, but redirected to the attendant group because the attendant is now busy
- Attendant Return Call — A call returned to the attendant after it times out. If the attendant is now busy, the call redirects to the attendant group.
- Serial Call — A call from the Attendant Serial Call feature when an outside trunk call (designated as a serial call by an attendant) is extended to and completed at a station, and then the station user goes on-hook. If the attendant who extended the call is busy, the call redirects to the attendant group.
- Individual Attendant Access Call — A call from a station user, incoming trunk call, or a system feature to the Individual Attendant Access (IAA) extension of a specific attendant. If the attendant is busy, the call queues until the attendant is available.
- Interposition Call — A call from one attendant to the Individual Attendant Access (IAA) extension of another attendant
- Miscellaneous Call — All other calls

You can assign the same priority level to more than one category. Assigning all categories the same priority level creates a first-in first-out queue.

When at least one call queues in the Attendant Priority Queue, the Calls Waiting lamp lights steadily on all active attendant consoles. If the number of calls in the queue reaches the attendant-group calls-waiting threshold, the Queue Warning lamp lights steadily on all active attendant consoles.

## Priority by Call Type

You can further define the priority assigned to calls in the Attendant Priority Queue by call type. Then, within each call type, prioritize calls by time (first-in first-out). The call types, in descending order of priority, are:

- Type 1 call: outgoing public-network calls receive answer supervision when the Answer Supervision Timer of the trunk group expires, even if the trunk is actually still ringing. Also, incoming calls when answered by the attendant.
- Type 2 call: incoming external public-network calls before they receive answer supervision or before the Answer Supervision Timer of the trunk group expires
- Type 3 call: all other calls (internal calls, conference calls, and tie-trunk calls of any type)

Note that external public-network calls have priority over all other calls including conference calls. And, answered public-network calls have priority over those calls not yet answered.

You can assign a Call Type button on the attendant console. Pressing this button displays the call type of the active call.

## Considerations

---

- An incoming call that defaults to an attendant and redirects to the attendant group, does not change the associated Attendant Priority Queue level. The reason-code display on the answering attendant's display remains the same as the code on the original attendant's display.

## Interactions

---

- **Multiparty Calls**  
The system always treats multiparty calls as Type 3 calls. If a multiparty call becomes a single-party call while in the queue it remains a Type 3 call.
- **Night Service — Hunt Group**  
When you use Night Service-Hunt Groups, retrieve calls from the hunt groups rather than the Attendant Priority Queue. Since call-type prioritization does not apply to hunt groups, do not retrieve calls in order of call-type unless you designate the Attendant Priority Queue as the termination.
- **Off Premises Station**  
Always identify calls from off-premises stations as Type 3 calls.

## Attendant Recall

---

Attendant Recall allows voice-terminal users on a 2-party call, or on an attendant conference call held on the console, to recall the attendant for assistance.

Single-line users press the RECALL button or flash the switch hook to recall the attendant.

Multiappearance users press the Conference or Transfer button to recall the attendant.

### How to administer Attendant Recall

---

None required

### Interactions

---

- Individual Attendant Access

If a user is holding a hunt-group call to an individual attendant on the console, a system user active on the call cannot recall the attendant. However, the user can transfer calls or make conference calls.



## **Attendant Release Loop Operation**

---

Attendant Release Loop Operation allows the attendant to hold any call off the console (such as a call extended to a busy single-line voice terminal or to a voice terminal that does not answer). The attendant is free to handle other calls.

### **How to administer Attendant Release Loop Operation**

---

None required

### **Detailed description**

---

When an incoming call arrives on a call appearance at an attendant console and is answered, extended, and released by the attendant, the call releases from that call appearance. The console is then available to receive the next call.

Timed Reminder (return-call Time-Out) starts once the call is off the console. If the called terminal or coverage-point user does not answer before the administered interval expires, the call returns to the attendant queue. The special recall tone applies and the alphanumeric display shows the call identification. Normal recall calls (for example, calls exceeding the Attendant Time Reminders on Hold setting) have normal ringing. You can administer either secondary ringing (recall ringing) or primary ringing (incoming call ringing).

Timed Reminders tries to return the call to the attendant who first handled it; if that attendant is unavailable, the call returns to the queue. The called station is no longer notified of the call.

### **Considerations**

---

- Attendant Release Loop Operation improves attendant efficiency by allowing the attendant to release from a call without having to wait for an answer.

### **Interactions**

---

- Attendant Display  
This feature provides call identification.
- Timed Reminder  
This feature provides a timed reminder tone and a return-call Time-Out interval.

## Attendant Serial Calling

---

Attendant Serial Calling enables the attendant to transfer trunk calls that return to the same attendant after the called party hangs up. Once outside callers reach an attendant, they can use the same line into the switch for multiple calls.

### How to administer Attendant Serial Calling

---

#### Required forms

---

| Form              | Field  | Page                 |
|-------------------|--|----------------------|
| Attendant Console | ■ Feature Button Assignments<br>— serial-cal | <a href="#">5-35</a> |

---

### Detailed description

---

Attendant Serial Calling is useful if trunks are scarce and Direct Inward Dialing services are unavailable. An outside caller may have to redial often to get through because trunks are so busy.

The attendant's display shows if a return call is a serial call. The code displayed is `sc`.

Attendant Serial Calling remains activated until either the trunk drops from the switch or the attendant deactivates the feature manually (by pressing the Serial Call button). Once the attendant answers the serial call, the lamp associated with the serial call button lights. If an attendant receives a serial call but has no Serial Call button, the attendant cannot deactivate the feature until the trunk hangs up or until an attendant with a Serial Call button takes control of the call.

If no attendants are available, then the call goes to the attendant's priority queue.

### Considerations

---

- Only attendants can activate this feature.
- The Attendant Serial Calling feature is valid only on calls that have only one trunk on the connection. You can administer only one Serial Call button per attendant console.
- You can activate the feature on a conference call as long as only one trunk is on the conference.

## Interactions

---

- Centralized Attendant Services  
Attendant Serial Calling does not work with Centralized Attendant Services.
- DCS  
Attendant Serial Calling works in a DCS environment only if the attendant activates it on the same node as the trunk to which the attendant is connected. Do not conference the incoming trunk call with a DCS party when activating. This would put two trunks on the connection.
- Priority Queue  
A special priority exists for serial calls.

## Audible Message Waiting

---

Audible Message Waiting places a stutter at the beginning of a station dial tone on a station that has a message waiting. Audible Message Waiting is particularly useful for visually impaired people who may not be able to see a message light.

Messages for a station can be waiting in system memory (to be accessed via display or voice synthesizer), Property Management System (PMS), Message Servicing Adjunct (MSA), or AUDIX.

Audible Message Waiting is typically, but not necessarily, used on voice terminals without message-waiting lights. Often these are analog terminals.

### How to administer Audible Message Waiting

---

#### Required forms

---

| Form                             | Field                     | Page                  |
|----------------------------------|---------------------------|-----------------------|
| System Parameter Customer-Option | ■ Audible Message Waiting | <a href="#">5-277</a> |
| Station                          | ■ Audible Message Waiting | <a href="#">6-28</a>  |

### Considerations

---

- You must inform the user where to call to retrieve messages.
- Use Clear Message Waiting Indicators to turn off message-waiting indicators when the system loses synchronization between voice terminals and message-status data.
- Audible Message Waiting requires a separate software right-to-use fee.
- Audible Message Waiting may not be applicable in countries that restrict the characteristics of dial tones provided to users.

### Interactions

---

None

## Authorization Codes

---

Authorization Codes provides the means for extending control of system users' calling privileges. They extend calling-privilege control and enhance security for remote-access callers.

Authorization codes may be used to:

- Override facility restriction levels (FRLs) assigned to originating stations or trunks
- Restrict individual incoming tie trunks and remote-access trunks
- Track CDR calls for cost-allocation purposes
- Provide additional security control

### How to administer Authorization Codes

---

#### Required forms

| Form                              | Field   | Page                  |
|-----------------------------------|---|-----------------------|
| Authorization Code — COR Mapping  | ■ AC, COR   | <a href="#">5-54</a>  |
| Feature-Related System Parameters | <ul style="list-style-type: none"> <li>■ Authorization Code Enabled</li> <li>■ Authorization Code Length</li> <li>■ Authorization Code Cancellation</li> <li>■ Symbol</li> <li>■ Attendant Time Out Flag</li> </ul> | <a href="#">5-123</a> |
| Station                           | ■ COR   | <a href="#">6-28</a>  |
| Class of Restriction              | ■ FRL   | <a href="#">5-72</a>  |
| Route Patterns                    | <ul style="list-style-type: none"> <li>■ Trunk Group Number</li> <li>■ FRL</li> </ul>   | <a href="#">8-67</a>  |
| Remote Access                     | ■ Authorization Code Remote Access Dial Tone  | <a href="#">5-258</a> |
| Trunk Groups:                     | ■ Auth Code   | <a href="#">7-115</a> |

### Detailed description

---

When an authorization code is dialed, the FRL assigned to the extension number, attendant console, incoming trunk group, or remote access trunk group being used for the call is replaced by the FRL assigned to the authorization code. The new FRL functions the same as the one it replaces; however, the new FRL may

represent greater or lesser calling privileges than the FRL that it replaces. Access to any given facility depends on the restrictions associated with the authorization code FRL.

### Example

A supervisor is at a desk of an employee and wants to make a call that is not normally allowed by the FRL assigned to that employee's extension. The supervisor, however, can still make the call by dialing an authorization code that is assigned an FRL that is not restricted from making that type of call.

For security reasons, authorization codes range from four to seven digits. The number of digits in the codes must be a fixed length for a particular DEFINITY ECS.

Incoming trunk groups within a system may be administered to always require an authorization code. The system applies recall dial tone to a call when the user must dial an authorization code. If the user dials a correct authorization code within 10 seconds (interdigit timeout), the call completes as dialed. If the user does not dial an authorization code or dials an incorrect authorization code, the call routes to the attendant, or routes to intercept tone, depending on system administration.

Normally, DID trunks should not require authorization codes. However, it can be done and care should be taken when administering DID trunks to require an authorization code, because different type calls could terminate at different endpoints, and requiring an authorization code could be confusing to the caller.

A Cancellation of Authorization Code Request (CACR) digit may be administered. The CACR digit cancels the 10-second interval between dialing. When the CACR digit is dialed, the call immediately routes according to system administration. (Incoming trunk calls receive intercept treatment or go to the attendant.) Other calls receive intercept treatment unless the user's FRL is high enough to route the call. A CACR digit from an off-premises extension over DID/Tie trunks use DID/Tie trunk intercept treatment. Internal calls receive intercept tone.

### CAUTION:

*Do not program passwords or authorization codes onto auto dial buttons. Display telephones display the programmed buttons, providing internal abusers access to the auto dial buttons to originate unauthorized calls. If passwords or authorization codes must be programmed onto auto dial buttons, use the ~s (suppress) character to prevent displaying the codes.*

## AAR and ARS Calls

Each authorization code is assigned a COR that contains an associated FRL. Within a system, access privileges are determined by the FRL assigned to the facility where the call is originated. When an AAR/ARS call is dialed, the system allows or denies the call based on the FRL of the originating station. COR is used to restrict internal or non-AAR/ARS calls.

Authorization codes are given to individual users and provide a method of specifying the level of calling privileges for that user regardless of the originating facility. Once an authorization code is required and dialed on an AAR/ARS call, the FRL assigned to the authorization code replaces the originating FRL and controls and defines the user's privileges.

An AAR or ARS call originated by a system user or routed over an incoming tie trunk may require a dialed authorization code to continue routing.

Extreme care should be taken when administering authorization codes, so that a user does not have to dial the authorization code more than once. For example, if a user makes an AAR or ARS call and the user's FRL is not high enough to access any of the trunks in the routing pattern, the system prompts the user for an authorization code. If the FRL assigned to the authorization code is high enough to access the next trunk group in the routing pattern, the user is not prompted to dial the code again. If the call is routed through another PBX, the user may be required to dial an authorization code again. This type of situation can be avoided through careful administration.

When an authorization code is required on some, but not all, trunk groups, the system prompts for an authorization code when the originating FRL is not adequate to access the next available trunk group in the routing pattern.

## Considerations

---

- From remote locations users typically access authorization from touch-tone stations. However they can also do so from rotary dialing stations at specified authorization-code-forced locations that follow appropriate trunk administration practices. Rotary station users access attendants via LDN or remote access numbers (RAN) and can experience a 10-second timeout.
- The use of Authorization Codes does not limit other call-control methods such as Toll Restriction, Miscellaneous Trunk Restriction, and Outward Restriction.
- For security reasons, authorization codes should be assigned randomly.
- If timeout to attendant does not occur or CACR digit codes are dialed instead of authorization codes, the system assumes that invalid authorization codes were dialed and the caller is given intercept tones.
- Authorization codes impact calling privileges by:

- Changing outgoing-call FRLs when they are insufficient to access preferred routing patterns assigned by AAR/ARS. FRLs are assigned to Class of Restrictions (COR) associated with user authorization codes. No additional COR data is assigned.
- Overriding COR for remote access calls assigned to barrier codes, when required. For remote-access calls, if an authorization code is required, the user is assigned the COR of the dialed authorization code, with all connected data, such as the FRL. This COR overrides the COR assigned to any required barrier code.
- Incoming trunk calls that require authorization codes do not change user privileges.

## Interactions

---

- AAR/ARS Partitioning  
Partitioned group numbers (PGN) are assigned by COR and Authorization Codes can change CORs. Therefore, PGNs can be changed on incoming remote access calls by authorization codes. For originating calls, user CORs determine PGNs.
- Cancellation of Authorization Code Request (CACR)

| If                                  | Then                 |
|-------------------------------------|----------------------|
| CACR = 1                            | ■ Authorization ≠ 1  |
| Network = DEFG1, DEFG3 or DEF ECSR5 | ■ CACR can be #      |
| Network - S85s, DIM PBX             | ■ CACR = 1 (default) |

- COR and FRL  
Authorization codes used for AAR/ARS calls override associated FRLs. Associated CORs determine remote-access user privileges.
- Forced Entry of Account Codes and CDR  
For 94A LSU (no longer supported) and 3B2 CDRU (no longer supported) 18-word records, authorization codes are output if administered account-code lengths are fewer than six digits. For 59-character records, authorization codes are never recorded.  
  
Authorization codes are recorded after destination addresses are dialed. Invalidly-dialed authorization codes are recorded, and patterns can be traced using CDR printouts.



## Auto Start and Don't Split

---

Auto Start and Don't Split allows the attendant to initiate a call by pressing any key on the keypad without having to first press the Start button.

### How to administer Auto Start and Don't Split

---

#### Required forms

---

| Form              | Field  | Page                 |
|-------------------|--|----------------------|
| Attendant Console | ■ Feature Button Assignments<br>— dont-split | <a href="#">5-35</a> |

---

### Detailed description

---

Auto Start reduces the number of buttons that attendants must press to handle calls. If the attendant is on a call and presses any key on the keypad, the system splits the call and dials the next call. The Start button is disabled and end-to-end signaling is not allowed.

To deactivate Auto Start, press the Don't Split button. To reactivate Auto Start, and allow end-to-end signaling, press the Don't Split button again, press Cancel, or let the current call terminate. When Don't Split is active, keys pressed on the keypad are heard by the parties on the call. Use Don't Split to send touch-tones to the far end to pick up answering-machine messages.

To extend a call to another extension in Auto Start mode, dial the extension. The call is automatically put on hold. Once the called party answers, press Release.

### Considerations

---

- If an attendant enables Auto Start and dials an AAR number where the min and max in the AAR analysis table are not equal, the attendant must dial a # after the digit string or the call does not process.

### Interactions

---

- CDR — Account Code Dialing  
If the system is using Call Detail Recording Account Code Dialing, Auto Start and Don't Split is not activated.
- Visually Impaired Service  
If VIS is activated or deactivated while Don't Split is active, Don't Split deactivates.

## Automated Attendant

---

Automated Attendant uses vector commands to allow a caller to enter the extension of the party that he or she would like to reach. The call is routed by the vector to that extension.

See “Treating Digits as a Destination” in Chapter 5 of the *DEFINITY Enterprise Communications Server Call Vectoring/EAS Guide* for a detailed description of Automated Attendant and for a sample vector that can be used for this feature. The guide contains information that is critical to the effective and efficient use of Automated Attendant.

### How to administer Automated Attendant

---

#### Required forms

| Form                                  | Field  | Page                  |
|---------------------------------------|--|-----------------------|
| System Parameters<br>Customer-Options | ■ Vectoring (Prompting)  | <a href="#">5-277</a> |
| Feature-Related System<br>Parameters  | ■ Prompting Timeout  | <a href="#">5-123</a> |
| Vector Directory Number               | ■ All  | <a href="#">9-214</a> |
| Announcements/Audio<br>Sources        | ■ Complete all fields for each extension that provides an Automated Attendant announcement | <a href="#">5-26</a>  |
| Hunt Group                            | ■ Vector   | <a href="#">5-158</a> |
| Call Vector                           | ■ Complete a form for each Automated Attendant vector                                      | <a href="#">9-207</a> |
| Station<br>(multi-appearance)         | ■ Button/Feature Button Assignments<br>- callr-info  | <a href="#">6-14</a>  |
| Attendant Console                     | ■ Feature Button Assignments<br>-callr-info  | <a href="#">5-35</a>  |

You can administer any display-equipped voice terminal or attendant console with a Caller Information CALLR-INFO button. The button displays digits collected for the last *collect digits* command.

### Considerations

---

Automated Attendant competes with several features for ports on the call classifier — detector circuit pack or equivalent.

## Interactions

---

- AUDIX

Automated Attendant gives the caller the option of leaving a message or waiting in queue for an attendant. See “Message Collection” in Chapter 5 of the *DEFINITY Enterprise Communications Server Call Vectoring/EAS Guide*.

- Authorization Codes

If authorization codes are enabled, and a *route-to* command in a prompting vector accesses AAR or ARS, if the VDN's FRL does not have the permission to use the chosen routing preference, then the system does not prompt for an authorization code and the *route-to* command fails.

- CallVisor ASAI

ASAI-provided digits can be collected by the Call Vectoring feature via the *collect* vector command as dial-ahead digits. CINFO is passed to CallVisor ASAI.

- Hold

If a call is put on hold during the processing of a *collect* command, the command restarts, beginning with the announcement prompt, when the call is taken off hold. All dialed-ahead digits are lost. Similarly, if a call to a vector is put on hold, vector processing is suspended when a *collect* command is encountered. When the call becomes active, the *collect* command resumes.

- Inbound Call Management (ICM)

You can use Automated Attendant to collect information that may later be used by an adjunct to handle a call.

- Transfer

If a call to a VDN is transferred during a *collect* command, the *collect* command restarts when the transfer is complete, and all dialed-ahead digits are lost. Similarly, if a call to a vector is transferred, vector processing is suspended when a *collect* command is encountered. When the transfer is complete, the *collect* command resumes. Attendant extended calls do suspend vector processing in the same way as transferred calls.

## Automatic Callback

---

Automatic Callback (ACB) allows internal users who placed a call to a busy or unanswered internal voice terminal to be called back automatically when the called voice terminal becomes available.

When a user activates ACB, the system monitors the called voice terminal. When the called voice terminal becomes available to receive a call, the system originates the ACB call. The originating party receives priority ringing. The calling party then lifts the handset and the called party receives the same ringing provided on the original call.

### How to administer Automatic Callback

---

#### Required forms

| Form                              | Field   | Page                  |
|-----------------------------------|---|-----------------------|
| Feature-Related System Parameters | ■ Automatic Callback — No Answer Timeout Interval (number of rings) | <a href="#">5-123</a> |
| Feature Access Code (FAC)         | ■ Automatic Callback Activation and Deactivation                    | <a href="#">5-113</a> |
| Station (multiappearance)         | ■ Button/Feature Button Assignments — auto-cback                    | <a href="#">6-28</a>  |
| Class of Service                  | ■ Auto Callback (0-15)  | <a href="#">5-81</a>  |

### Detailed description

---

A single-line voice terminal user activates this feature by pressing the Recall button or flashing the switchhook and then dialing the ACB access code. A single-line user can activate ACB for only one call at a time.

A multi-appearance voice terminal user can activate ACB for the number of ACB buttons assigned to the terminal. After placing a call to a voice terminal that is busy or that is not answered, the caller simply presses an idle ACB button and hangs up.

If the calling voice terminal user answers an ACB call, and for some reason the called extension cannot accept a new call, the calling user hears confirmation tone and then silence. The call is still queued.

Users cannot activate ACB for calls to:

- An attendant console group
- A voice terminal assigned Termination Restriction
- A voice terminal when using Automatic Call Distribution

- An extension with ACB already activated toward it
- A data terminal (or data module)
- A Direct Department Calling group
- A Uniform Call Distribution group
- A Terminating Extension Group
- A VDN Extension

## Considerations

- The system cancels an ACB request for any of the following reasons:
  - The called party is not available within 30 minutes.
  - The calling party does not answer the callback call within the administered interval (2–9 ringing cycles).
  - The calling party decides not to wait and presses the same ACB button a second time (multi-appearance voice terminal) or dials the ACB cancellation code (single-line voice terminal).
- ACB is administered to individual voice terminals by their COS and cannot be assigned to the attendant(s). Multi-appearance voice terminals must have an ACB button to activate the feature.
- ACB works differently depending on if the called party was busy or did not answer the call. For a busy call, ACB takes place as soon as the called party hangs up. If the called party did not answer, the voice terminal must be used for another call and then hung up before ACB is activated.

### NOTE:

If the ACB originator has all line appearances occupied when the ACB call comes in, the user will hear priority ringing once, and the ACB lamp will blink. However, if the user presses the ACB button to answer the ACB call, one of the other calls will drop.

## Interactions

- Attendant Call Waiting and Call Waiting Termination  
If a user activates ACB to or from a single-line voice terminal, Call Waiting Termination is denied.
- Attendant Intrusion  
Attendant Intrusion does not work if a user has activated ACB.
- Bridged Call Appearance  
Users cannot activate ACB from a bridged call appearance. If a user activates ACB from a primary extension number, the return-call notification rings at all bridged call appearances.

- **Busy Verification**  
If a voice terminal has activated ACB, you cannot perform Busy Verification of that terminal.
- **Call Coverage**  
ACB calls do not redirect to coverage.
- **Call Forwarding**  
If the called voice terminal has Call Forwarding activated, the calling party cannot activate ACB. However, if ACB was activated before the called voice terminal user activated Call Forwarding, the system redirects the callback call attempt toward the forwarded-to party.
- **Call Pickup**  
A group member cannot answer a callback call for another group member.
- **Class of Restriction**  
Voice terminals with origination restriction cannot activate ACB.
- **Conference and Transfer**  
A single-line voice-terminal user cannot activate conference or transfer if ACB is active.
- **DCS**  
ACB operates over a DCS network as if it were on a local switch.
- **Hold**  
A single-line voice terminal cannot receive ACB calls if the user has placed a call on hold.
- **Hot Line Service**  
Voice terminals administered for Hot Line Service cannot activate ACB.
- **Intercom - Automatic and Dial**  
Intercom calls are not eligible for ACB.
- **Internal Automatic Answer (IAA)**  
IAA does not automatically answer ACB calls.
- **Manual Originating Line Service**  
Voice terminals with Manual Originating Line Service cannot activate ACB.
- **Ringback Queuing**  
Users can press an ACB button to activate Ringback Queuing.

- Voice Terminal Display

When the system generates an ACB call, the display of the originating voice terminal displays *ACB* (or the equivalent for Administrable Language Displays).

## Automatic Circuit Assurance

---

Automatic Circuit Assurance (ACA) helps you identify possible trunk malfunctions. With ACA enabled, the system measures the holding time of each trunk call. If the measurements show calls with either extremely long or extremely short holding times, DEFINITY ECS places a referral call to an attendant or voice terminal.

The system records holding time from when a trunk is accessed to when it is released. You set short-holding-time and long-holding-time limits for each trunk group. The system then compares the recorded holding times against these limits.

### How to administer ACA

---

#### Required forms

---

| Form                              | Field  | Page                  |
|-----------------------------------|--|-----------------------|
| Feature-Related System Parameters | ■ Automatic Circuit Assurance (ACA) Enabled                  | <a href="#">5-123</a> |
|                                   | ■ ACA Referral Calls   |                       |
|                                   | ■ ACA Referral Destination                                   |                       |
|                                   | ■ ACA Short Holding Time Originating Extension               |                       |
|                                   | ■ ACA Long Holding Time Originating Extension                |                       |
|                                   | ■ ACA Remote PBX Identification (if Referral Calls = remote) |                       |
| Trunk Group (All)                 | ■ ACA Assignment   | <a href="#">7-115</a> |
|                                   | ■ Short Holding Threshold                                    |                       |
|                                   | ■ Long Holding Time (hours)                                  |                       |
|                                   | ■ Short Holding Time (seconds)                               |                       |
| Attendant Console                 | ■ Feature Button<br>— aca-halt                               | <a href="#">5-35</a>  |
| Station                           | ■ Feature Button<br>— aca-halt                               | <a href="#">5-35</a>  |



## Detailed description

---

You enable ACA for the entire system, and administer thresholds for individual trunk groups. You can have all trunks or only certain trunks measured.

DEFINITY ECS deals with long-holding and short-holding calls differently. For every call that is shorter than the administered short-holding time, the system increases the short-holding counter by 1. For calls over the same trunk that are within the normal range, it decreases the short-holding counter by 1. Thus, trunks that handle a normal variety of call lengths are not singled out as faulty. If the counter reaches the administered short-holding threshold, the system places a referral call.

If one long call exceeds the long-holding time, the system makes a referral call.

### The referral call

The display or voice-synthesized message that accompanies an ACA call contains the following information:

- The fact that this is an ACA call
- The trunk access code, trunk group number, and trunk group member number
- The type of referral (short or long holding time)

Once the referral call is answered, this information is displayed and remains displayed until the call is released. If the call is not answered within three minutes, the call stops. The system places the call again after one hour, and continues to place the call hourly until someone answers.

The attendant or voice-terminal user who receives the referral call can stop further calls by pressing the `aca-halt` button, if one is provided. This is a toggle button, and turns off the feature until the user presses the button again.

### The audit trail

Each time a referral call is necessary, the system also adds a record to an audit trail. Audit trail records are available on the ACA Measurements Report. Each record contains the following information:

- Time and date of referral
- Trunk group number, trunk access code, and trunk group member
- The type of referral (short or long holding time)

The audit trail contains up to 64 records. New records overwrite older ones when the buffer is full. *DEFINITY ECS System Monitoring and Reporting* contains more information on the ACA Measurements Report.

## Considerations

---

- You cannot measure personal CO lines, out-of-service trunks, or trunks undergoing maintenance testing.

## Interactions

---

- Administrable Language Displays  
You cannot administer languages for ACA messages.
- AUDIX  
Do not set the referral-call extension to a terminal that covers to AUDIX. AUDIX could potentially overload with the volume of calls, because ACA calls remain active for up to three minutes.
- Busy Verification of Terminals and Trunks  
Once you have identified a potentially defective trunk, you can use Busy Verification to check it.
- Centralized Attendant Services  
When CAS is activated, the referral-call destination must be on the local switch. The system interprets a referral destination of 0 as the local attendant, if one exists. The CAS attendant cannot activate or deactivate ACA referral calls at a branch location.
- DCS  
Referral calls may be placed across a DCS network. One switch (the primary) is administered to receive ACA referred calls from remote nodes for all switches within the network. You must administer the field ACA Remote PBX Identification with the PBX ID of the node that is designated as primary.  
If ACA referral calls are sent off the switch that generates the referral, the display and voicing information indicating the failed trunk is lost, even if the referral call is made over a DCS network.
- Internal Automatic Answer  
ACA calls are not eligible for IAA.
- Night Service  
Referral calls to the attendant are not placed if the system is in Night Service mode.
- Visually Impaired Attendant Service  
If the attendant presses the DISPLAY STATUS button and an ACA call has not been answered, then the words *Automatic Circuit Assurance* are voiced.

## 4 Basic Features

### *Automatic Circuit Assurance*

Page 4-107

If a visually-impaired attendant presses the DISPLAY STATUS button and the ACA call has been answered, then the words *Automatic Circuit Assurance* and the extension assigned to the ACA call are voiced.

If your switch contains a voice-synthesis board, ACA referral calls are accompanied by an audible message identifying the type of ACA infraction encountered. The message is "Automatic circuit assurance <long> or <short> holding time threshold has been exceeded for trunk group <#> member number <#>."

- Voice Message Retrieval

If you use Voice Message Retrieval, you can assign a nondisplay voice terminal as a referral destination.

- Wideband Switching

ACA treats wideband-trunk calls as a single-trunk call and therefore triggers a single referral call. The call information shows the lowest B-channel trunk member associated with the wideband channel.

## Automatic Incoming Call Display

Automatic Incoming Call Display allows the system to provide information about an incoming call when the called party is active on a call. The system does this by displaying incoming call information on the called party's display-equipped voice terminal.

### How to administer Automatic Incoming Call Display

You do not need to administer this feature. However, if you want the displays to be in a language other than English, (the system default language), you need to administer the language you want to use. See [“Administrable Language Displays” on page 4-20](#) for information on administering non-English displays.

### Detailed description

The system replaces any display information with the identity of the incoming call. It displays the information for 30 seconds unless:

- The called party receives another call.  
In this case, the system overwrites the current display with information about the incoming call. This is true for each new incoming call.
- The called party hangs up.  
In this case the system clears the display.
- The calling party hangs up.  
In this case the system returns to the previous display information.

The display returns to the current call information after 30 seconds unless the information is displayed on a CALLMASTER terminal. In that case, the display goes blank after 30 seconds.

If the called party is in the process of placing a call, the system does not replace the display information with incoming call information.

### Considerations

- The system displays call information only if the call terminates at the called party's voice terminal. For example, the system does not display information when it forwards a call to another extension.
- The called party's voice-terminal display must be on and in the normal mode to display call information.

## Interactions

---

- Station Type PC/PBX

The system may omit the call-appearance designation (a=, b=, c=, d=) information in order for the find capability of the Call Log in the PC/PBX Connection software to work properly.

- Trunks

When a caller makes an outgoing trunk call on a trunk group and the Trunk Group form's *Outgoing Display Option* field set to **no**:

- Incoming station calls to the caller do not replace the display while the caller is on the call.
- Incoming trunk calls to the caller do not replace the display while the caller is on the call.

The caller's dialed number stays on the display and is not replaced by the trunk group name.

- Voice Terminal Display

The Automatic Incoming Call Display feature enhances the Voice Terminal Display feature by providing automatic identification of incoming calls. The same incoming-call information can be provided by putting the display in the inspect mode. However, this is not automatic; you must reset the mode manually for each call.

## Block Collect Call

---

Block Collect Call disallows collect calls on a trunk group by trunk group basis. This feature is used only with central offices (COs) that react in this manner to a 2-second flash. COs in Brazil do so.

### How to administer Block Collect Call

---

#### Required forms

---

| Form        | Field          | Page                  |
|-------------|----------------|-----------------------|
| Trunk Group | ■ Country      |                       |
|             | ■ Flash Length |                       |
|             | — CO           | <a href="#">7-168</a> |
|             | — DID          | <a href="#">7-178</a> |
| — DIOD      |                | <a href="#">7-183</a> |

---

- Set Country to **23** and the Flash Length to **2000** on each trunk group form.

### Detailed description

---

Block Collect Call is administered by trunk group for CO, DID, and DIOD trunks.

If these two fields (Country and Flash Length) on a trunk group are set to the above values, on all incoming calls by this trunk group, the switch sends a double answer. This is a short answer followed by a flash for 2 seconds.

If a call is collect, it is blocked. The central office (CO) either returns a busy tone on analog CO trunks or signals a disconnect on analog DID or digital trunks.

If a call is not collect, a 2-way talk path is re-established after double answer.

### Interactions

---

- Automatic Call Distribution

During the double-answer interval, the agent hears clicking or silence.

Forced announcement is recommended to prevent agents from answering a call before the double-answer interval completes.

- BCMS

Calls are recorded only when they are answered by an agent or an announcement. Calls that drop are recorded as abandoned calls.

- Busy-Tone Detection

An OEM/CPE Busy-Tone Detection adjunct for analog trunks is *highly* recommended for use with this feature. It prevents connecting abandoned calls to the answering agent, and locking up trunk-to-trunk connections and repetitive announcements.
- Call Coverage

Block Collect Call does not apply to calls that cover off-net.
- Call Forward

Block Collect Call does not apply to calls that forward off-net.
- Call Vectoring

The double-answer interval applies before any vector steps are processed.
- Distributed Communications System

Block Collect Call is available only on trunks that come into a switch and are answered by a station on the same switch.
- Electronic Tandem Network

Block Collect Call is not provided over ETN trunks.
- Remote Access

Do not use Block Collect Call on remote-access trunks. They require a barrier code and are not directed toward a station.
- Voice Terminal

During the double-answer interval, the called party hears clicking or silence. The voice terminal displays the same caller information with Block Collect Call as it does without it.

## Bridged Call Appearance

Bridged Call Appearance allows single-line and multiappearance voice-terminal users to have an appearance of another user's primary extension number. The bridged call appearance can be used to originate, answer, and bridge onto calls to or from the other user's primary extension number.

### How to administer Bridged Call Appearance

#### Required forms for Single-Line Voice Terminals

| Form                              | Field   | Page                  |
|-----------------------------------|---|-----------------------|
| Coverage Path                     | <ul style="list-style-type: none"> <li>■ Terminate Coverage Pts. with Bridged Appearance?</li> </ul>                      | <a href="#">5-94</a>  |
| Feature-Related System-Parameters | <ul style="list-style-type: none"> <li>■ Prohibit Bridging with Data Privacy</li> </ul>                                   | <a href="#">5-123</a> |
| Station (multiappearance)         | <ul style="list-style-type: none"> <li>■ Bridged Call Alerting</li> <li>■ Feature Button Assignments brdg-appr</li> </ul> | <a href="#">6-14</a>  |
| Station (single-line)             | <ul style="list-style-type: none"> <li>■ Line Appearance</li> </ul>   | <a href="#">6-28</a>  |

#### Required forms for Multiappearance Voice Terminals

| Form                              | Field   | Page                  |
|-----------------------------------|---|-----------------------|
| Coverage Path                     | <ul style="list-style-type: none"> <li>■ Terminate Coverage Pts. with Bridged Appearances?</li> </ul>   | <a href="#">5-94</a>  |
| Feature-Related System-Parameters | <ul style="list-style-type: none"> <li>■ Prohibit Bridging with Data Privacy</li> </ul>   | <a href="#">5-123</a> |
| Station (multiappearance)         | <ul style="list-style-type: none"> <li>■ Auto Select Any Idle Appearance</li> <li>■ Bridged Call Alerting</li> <li>■ Feature Button Assignments abrdg-appr</li> <li>■ Feature Button Assignments brdg-appr</li> </ul> | <a href="#">6-14</a>  |



## Detailed description

An appearance of a voice terminal's primary extension number at another voice terminal is called a bridged call appearance. A bridged call appearance can be used to originate, answer, or bridge onto an existing call to or from the primary terminal user's extension number.

On single-line voice terminals, Bridged Call Appearance is used by going off-hook. On multiappearance voice terminals, Bridged Call Appearance is used by going off-hook and pressing the bridged appearance button. In both cases, the user is then bridged onto the primary terminal's extension number and can handle calls on that extension number.

An incoming call rings the primary extension number's voice terminal and all voice terminals that have a bridged call appearance of the voice terminal's primary extension number. Each voice terminal is visually alerted for all bridged appearances on the voice terminal, but has the option of audible ringing.

On multiappearance voice terminals, a bridged call appearance can be assigned to any 2-lamp button. It does not require the use of a regular call appearance.

A bridged call appearance can be used just like a regular call appearance for most features. For example, Conference, Transfer, Hold, Drop, and Priority Calling can be used from a bridged appearance, just as they are used from a regular call appearance.

You can administer a voice terminal with zero call appearances of its primary extension. In this way, a voice terminal can be administered to have only bridged appearances.

## **Extension administrable buttons and lamps for multiappearance voice terminals**

You can administer the message lamp and some feature buttons to apply to a specified extension rather than the extension of the terminal they reside on.

- You can administer the message lamp to light when messages are waiting for the extension specified on the Station form. In this way, the bridged user's terminal can be set up to indicate when messages are waiting for the primary extension.
- You can administer the call forwarding all calls and call forwarding busy/don't answer buttons to activate Call Forwarding for any extension that is on the voice terminal, even if this extension is a bridged appearance. In addition, you can administer the lamp associated with the call forwarding button to track the call forwarding status of any extension. In this way, a bridged user can activate or deactivate Call Forwarding for

all primary and bridged appearances of the extension from the bridged appearance terminal, and the bridged appearance terminal shows the call forwarding status of the specified extension.

- You can administer the send all calls button to activate Send All Calls for any administered extension. The lamp associated with Send All Calls tracks the status of the administered extension. In this way, a bridged user can activate Send All Calls for the primary extension user.

## Sample applications

- A secretary making or answering calls on an executive's primary extension  
These calls can be placed on hold for later retrieval by the executive, or the executive can simply bridge onto the call. In all cases, the executive handles the call as if he or she had placed or answered the call. It is never necessary to transfer the call to the executive.
- A secretary taking care of details for an executive who is already active on a call  
A secretary can bridge onto an active call and take down information such as an address or telephone number.
- Visitor telephones  
An executive may have another voice terminal in their office that is to be used by visitors. It may be desirable that the visitor be able to bridge onto a call that is active on the executive's primary extension number. A bridged call appearance makes this possible.
- Service environments  
It may be necessary that several people be able to handle calls to a particular extension number. For example, several users may be required to answer calls to a hot line number in addition to their normal functions. Each user may also be required to bridge onto existing hot line calls. A bridged call appearance provides this capability.
- A user frequently using voice terminals in different locations  
A user may not spend all of their time in the same place. For this type of user, it is convenient to have their extension number bridged at several different voice terminals.
- Executive suite environments (multiappearance voice terminals only)  
You can administer terminals with zero call appearances of their primary extension number. When this feature is combined with extension administrable buttons and lamps, it is possible to administer several nearly identical phones for one office suite. You can then operate their voice terminal the same way regardless of which voice terminal is being used.

## Considerations for single-line voice terminals

- The number of bridged call appearances allowed varies by system. See *DEFINITY Enterprise Communications Server Release 6 System Description Pocket Reference* for those numbers. A bridging user cannot have more than one bridged appearance for a particular primary terminal. However, a multiappearance bridging user can have appearances of more than one analog terminal on their terminal (a multiappearance bridging user, by use of different buttons, can bridge onto several different primary terminals).
- The number of bridged appearances allowed on a multiappearance bridging user's terminal is limited only by the number of 2-lamp buttons available on the terminal.
- If the primary single-line terminal is correctly administered, but not in service, calls can still be placed by the bridging users, and received on the bridged appearances of the terminal. The primary terminal can be out of service for several reasons, such as an unplugged terminal, a nonexistent terminal system technician busyout command, etc.
- If more than one user goes off-hook on a bridged appearance at the same time, only the user who was the first to go off-hook can dial.
- If a bridging user is not active on a call, and bridges onto the appearance of an active call, the user is bridged onto the active call. If a multiappearance bridging user is active on a call, and bridges onto the appearance of an active call, the previously selected call is dropped and the user is bridged onto the active call.
- The Privacy-Manual Exclusion feature can be activated by the bridging user only, while active on a call, to prevent accidental bridging of an active call.
- If a call terminates at a voice terminal on an extension number other than the primary extension number (for example, terminating extension group (TEG), uniform call distribution (UCD) group, call coverage answer group, or direct department calling (DDC) group extension number), a bridged call appearance is not maintained. Therefore, the primary terminal should not be made a member of such a group (even though administration of this is not prohibited).
- The Bridged Call Appearance feature should not be considered as a replacement for Call Coverage or any other similar features.
- If two parties are bridged together on an active call with a third party, and if the conference tone feature is enabled, conference tone is heard.

## Considerations for multiappearance voice terminals

---

- The number of bridged call appearances allowed at each voice terminal is limited only by the number of 2-lamp buttons available on the voice terminal. The number of appearances per primary extension varies by system. See *DEFINITY Enterprise Communications Server Release 6 System Description Pocket Reference* for this information.
- Up to six parties can be off-hook and involved in a conversation on a bridged appearance of an extension.
- A bridging voice terminal should have a bridged call appearance corresponding to each call appearance of the primary extension number at the bridged voice terminal. For example, if a primary voice terminal has three call appearances, a bridging voice terminal should have three bridged call appearances of that primary extension. This allows users to refer to the individual call appearances when talking about a specific call.
- Bridged call appearances may result in the reduction of available feature buttons, thereby reducing a user's capabilities. A Call Coverage module or expansion module can be used to provide up to 20 bridged call appearances. This leaves the other 2-lamp buttons as call appearances, or with other features such as Centralized Attendant Service (CAS).
- If a call terminates at a voice terminal on an extension number other than the primary extension number (for example, TEG, UCD group, call coverage answer group, or DDC group extension number), a bridged call appearance is not maintained. Therefore, the primary terminal should not be made a member of such a group (even though administration of this is not prohibited).
- Bridged Call Appearance should not be considered a replacement for Call Coverage.
- You can administer conference tone, which, when enabled, is heard when two parties are bridged together on an active call with a third party.

## Interactions

---

- Abbreviated Dialing

A user, accessing Abbreviated Dialing while on a bridged call appearance, accesses their own Abbreviated Dialing lists. The user does not access the Abbreviated Dialing lists of the primary extension associated with the bridged call appearance.

A user cannot use an abbreviated dialing FAC after using a priority calling FAC.
- Adjunct Switch Applications Interface (ASAI)

If you are using ASAI, do not administer more than 16 bridged appearances.

- Attendant Display and Voice Terminal Display

A call from the primary extension number or from a bridged call appearance of the primary extension number is displayed as a call from the primary extension number (the call is displayed as coming from the primary extension number regardless of which appearance placed the call).

On multiappearance voice terminals, the display at a principal shows the same information for a bridged call appearance as it does for a nonbridged call. For calls to the principal's extension number, the display at a zero call appearance bridging station shows a call from the originator to the principal with no "redirection reason" character. As stations bridge onto the call, the display updates to show the number of parties in the conference.

- Automatic Call Distribution

Bridged appearances cannot be accessed via non-ACD hunt groups (although administrable).

- Automatic Callback

Automatic Callback calls cannot originate from a bridged call appearance. However, when Automatic Callback is activated from the principal user's station, the callback call rings (with priority call distinctive ringing signal) at all bridged appearances of the extension as well as at the principal user's station. Displays at all stations (principal and bridged users) show that it is a callback call.

- Call Coverage

- Single-line voice terminals

When an analog station is administered as a bridged call appearance, the terminal user cannot invoke Send All Calls for the extension of their voice terminal. The user does not have a send all calls button, and the call appearance is associated with another extension. When the user dials a feature-access code (FAC), Send All Calls is activated for the extension associated with the call appearance.

- Multiappearance voice terminals

Coverage criteria for bridged call appearances is based entirely on the criteria of the primary extension associated with bridged appearance. A call to the primary extension that requires call coverage treatment follows the coverage path of the primary extension and not the path of any of the bridged appearances. Bridged call appearances do not receive redirection notification.

A user with bridged call appearances can activate or deactivate Send All Calls for a principal's primary call appearance if they are on the bridged appearance.

The primary terminal should not be a member of a call coverage group, because calls to the primary terminal as a member of the group are not bridged.

You can administer the system so that a call can appear at a terminal as both a bridged call and a redirected call. In this way, if the bridged user is the first coverage point, the call redirects to that terminal when the coverage criteria are met.

If the principal is an analog voice terminal with a bridged call appearance on a multiappearance voice terminal, an incoming call to the analog voice terminal that goes to coverage terminates at a primary call appearance on the bridging user's voice terminal as a coverage call. If the bridging user is a zero primary call appearance voice terminal, the call cannot redirect to the bridging user since there are no primary call appearances. Therefore, the call redirects to the next available coverage point.

- Call Detail Recording

If a bridging user originates or answers a call on a bridged appearance, the extension of the bridge is recorded as the calling/called terminal. A conference or transfer by a bridging user also appears as though it was performed by the terminal user.

On multiappearance voice terminals, when a call originated from a bridged call appearance on a terminal administered for zero primary call appearance is recorded by CDR, the extension number associated with the appearance is recorded as the calling party. A conference or transfer by a bridged call appearance on a zero primary call appearances terminal also appears as though it were performed by the extension associated with the appearance.

- Call Forwarding All Calls, Call Forward Busy/Don't Answer

Call Forwarding can be activated or canceled for the primary extension number from any bridged call appearance of that number. When activated, calls to the primary extension number do not terminate at the bridged call appearances, but go to the designated forwarding destination. Bridged call appearances do not receive redirection notification of the call to the primary extension when it is forwarded unless Ringing — Abbreviated and Delayed is administered.

- Call Park

When a call is parked from a bridged call appearance, it is parked on the primary extension number.

- Call Pickup

- Single-line voice terminals

Calls to the primary terminal, alerting at bridged appearances of the primary terminal, can be picked up by member's of the bridging user's call pickup group. This causes all bridged appearances of the call to be dropped.

Calls ringing at a primary terminal can be picked up by members of the primary terminal's call pickup group. However, if the primary terminal and the bridging user's terminal are not in the same call pickup group, the bridging user cannot pick up calls to other members of the primary terminal's call pickup group.

Originating on a bridged appearance and dialing the call pickup FAC is interpreted as an attempt to pick up a call from the primary terminal's call pickup group.

A bridging user can use Call Pickup to pick up a call that is alerting at a bridged appearance, instead of selecting the bridged appearance button. This causes the call at the primary terminal and all bridged appearances of the call to be dropped.

If the bridging user has appearances of numerous single-line (primary) terminals (for example, sales, service, and warehouse), and it is not desired that the calls be answered by anyone other than the primary terminal user or the bridging users, the bridging user(s) should not be assigned to a pick up group.

— Multiappearance voice terminals

If a voice terminal receives ringing on a bridged call appearance, the incoming call can be picked up by members of that voice terminal's call pickup group. This causes all bridged call appearances to be dropped. Calls ringing at a primary terminal can be picked up by members of the terminal's call pickup group. However, if the primary terminal and the bridging user's primary terminal are not in the same call pickup group, the bridging user cannot pick up calls to other members of the primary terminal's call pickup group.

Originating on a bridged appearance and dialing the call pickup FAC is interpreted as an attempt to pick up a call from the primary terminal's call pickup group.

A bridging user can use Call Pickup to pick up a call that is alerting at a bridged appearance, instead of selecting the bridged appearance button. This causes the call to terminate on the bridging user's primary extension button, and the primary terminal and all bridged appearances of the call are dropped.

If the bridging user has appearances of numerous terminals (for example, sales, service, and warehouse), and it is not desired that the calls be answered by anyone other than the terminal user or the bridging users, the bridging users should not be assigned to a pick up group.

A terminal with zero primary call appearances can be assigned to a call pickup group.

- Call Waiting Termination (single-line voice terminals only)

Call Waiting Termination applies only to an active call on the primary terminal that has no one else bridged on. If one or more bridging users are active on a call, call waiting calls are denied whether or not the primary user is also off-hook on the call. A bridging user can bridge onto a call with the primary user if there is also a call waiting.

- Class of Restriction (multiappearance voice-terminal users only)

The COR assigned to a voice terminal's primary extension also applies to calls originated from a bridged call appearance.

- Conference — Attendant, Conference — Terminal

- Single-line voice terminals

A bridged call cannot be conferenced if more than one user is active on that call. This is because the bridging user has no access to the call after the primary terminal user places the call on soft hold, and the primary terminal user has no access to the bridging user's call appearance used for conference/transfer attempts.

If a bridging user is active on a bridged call and the primary analog terminal user attempts a conference, the attempt is ignored. The same is true if an analog bridging user attempts a conference when the primary terminal user and another bridging user is active on a call.

When the primary terminal user is active on a call, and no other bridging user is active on the call, that call can be placed on hold by the primary terminal user utilizing normal single-line conference procedures. Any attempt by a bridging user to bridge onto the call during a successful conference attempt is denied.

A bridging user, alone on a bridged call, can conference the call utilizing the normal multiappearance terminal conference procedures. Any attempt by the analog primary terminal user to bridge onto the call during a successful conference attempt is ignored. Any attempt by other bridging users is denied (standard denial response is returned to the bridged appearance).

If a conference is not allowed because of the preceding limitations, the user can accomplish a transfer by asking an internal nonbridged party in the connection to create the conference, or asking the remaining bridging users and primary user to disconnect so that the conference can be completed. At completion of the conference, the parties that left the call can reenter the call if control of the conference remains with the primary terminal. If control of the conference does not remain with the primary terminal, the bridging user must conference the primary terminal and the bridging user back into the call as required.



If the bridging user has no other available bridged appearances of the primary extension (other than the one he or she is currently on), the bridging user, after pressing the conference/transfer button, must select a call appearance to be used for the conference, before dialing the number.

— Multiappearance voice terminals

Call Waiting Termination applies only to an active call on the primary terminal that has no one else bridged on. If one or more bridging users are active on a call, Call Waiting calls are denied whether or not the primary user is also off-hook on the call. A bridging user cannot bridge onto a call with the primary user if there is also a call waiting.

Conferences can be set up on bridged appearances using the usual conference operations. Either a primary extension button or a bridged appearance button can be used to make the calls for adding to the conference.

You can administer the system to automatically select the first idle appearance if there is no idle appearance with an extension matching the extension that is conferencing the call.

When the user presses the conference button (the second time) to connect the parties together, the newly formed conference call appears on the primary or bridged appearance to which the user was connected at the time of that last conference button depression. The other appearance is disassociated from the conference call. Therefore, if the original call is on a bridged appearance, and the conference is formed on an appearance of the bridged user's own primary extension, the bridged extension becomes disassociated from the conference call and the principal user of that bridged extension can no longer bridge onto the conference.

This disassociation of the conference from the bridged extension can be avoided by setting up the conference in the opposite order. To do this, the user:

1. Presses the hold button to hold the original call on the bridged appearance
2. Selects a call appearance and calls the party to be added
3. Presses the conference or transfer button
4. Selects the held bridged appearance
5. Presses the conference button (again)

When this procedure is used, the conference is formed on the bridged appearance so that the primary user of the bridged extension can still bridge onto the conference call.

If the primary user and the bridged user are both on the call when one user transfers the call, the user performing the transfer becomes the controlling user for the participation of both users on the conference. To disassociate the appearance from the call, the controlling user must be the latter of the two users to hang up from the call. If the controlling user hangs up first, the appearance goes on soft hold when the noncontrolling party hangs up. In this case, one of two things must occur to disassociate the appearance from the call: all other parties on the call hang up, or the controlling user rejoins the call and hangs up again.

The display shows the number of other active parties in a call, including active bridged appearances.

- Consult (multiappearance voice terminals only)

Bridged call appearances of the primary extension do not ring on a consult call to the primary extension.

- Coverage Answer Group

- Single-line voice terminals

The primary (analog) terminal is not a member of a call coverage answer group, because calls to the primary terminal as a member of the group *are not bridged*.

If the primary terminal is made a member of a coverage group, coverage criteria is based entirely on the criteria of the primary terminal. This means that a call to the primary terminal that requires call coverage treatment follows the path of the primary terminal and not the path of any of the terminals with bridged appearances of the primary terminals. In this case, it is desirable to have the bridging user in the coverage path of the primary terminal. Then, when a call to the primary terminal requires coverage treatment, it follows the coverage path to the bridging user's terminal, call appearances of the call are dropped, and the call terminates at the bridging user's terminal as a coverage call.

- Multiappearance voice terminals

Bridged call appearances of a primary extension do not ring when there is a CAG call to the primary extension. Bridged call appearances cannot bridge onto the call.

- Data Privacy, Data Restriction

When Data Privacy is activated or Data Restriction is assigned to a station involved in a bridged call and the primary terminal and/or bridging user attempts to bridge onto the call, Data Privacy and Data Restriction are automatically overridden (or deactivated in the case of Data Privacy).

- Facility Busy Indication (multiappearance voice terminals only)

The call is placed to the resource from the first available bridged call appearance for zero primary call appearance voice terminals.

- Hold — Automatic

- Single-line voice terminals

A call cannot be put on hold if more than one user is active on that call.

The primary terminal user, when no other bridges are active on the call, can put the call on hold, using normal single-line hold procedures. If the primary terminal user successfully soft holds the call, the status lamp at all of the bridged appearances shows the hold indication; and then the call can be put on hard hold by dialing the hard hold FAC. The hard held call is no longer accessible to the bridging users until it is taken off hold by the primary terminal user. After the call is put on hard hold, any new call to the primary terminal is tracked by the bridged appearances.

A bridging user can place an active call on hold (if the primary terminal or any other bridges are not active on the call) by using normal multiappearance hold procedures. Any attempt to enter the held call returns it to the status of an active call that can then be accessed using bridging procedures.

If hold is not allowed because of the preceding reasons, the user can just go on-hook and then reenter the call as required, because the call remains accessible as long as the primary terminal or any bridging user is active on it.

- Multiappearance voice terminals

Any user (primary or bridged appearance) can place an active call on hold. If only one user is active on a call and places that call on hold, the indicator lamp at both the principal's appearance button and the bridged party's appearance button shows that the call is on hold. If more than one user is bridged onto the active call, and one of the users activates Hold, the activator receives "hold" indication for the call and status lamp of all other bridged users remains active.

- Hotline Service (single-line voice terminals)

If a single-line voice terminal is administered for Hotline Service, bridged appearances of that voice terminal's extension also places a hot line call automatically when a user goes off-hook on that bridged appearance.

- Hunt Group (DDC or UCD)

Bridged call appearances cannot be used in conjunction with DDC or UCD hunt groups.

Although you can assign a bridged extension to a hunt group, such assignment is not recommended because DDC/UCD calls do not terminate at any bridged appearances of that extension on other stations.

## 4 Basic Features

### *Bridged Call Appearance*

Page 4-124

- Intercom — Automatic and Intercom — Dial (multiappearance voice terminals only)

Bridged appearances of a primary extension number are not rung for intercom calls. Furthermore, if a station has no primary call appearances it can never be rung for an intercom call. Therefore, if a secretary is screening all calls for the principal, and is indicating who is calling via intercom, the principal must have a call appearance on which to receive and send intercom calls.

- Internal Automatic Answer

Calls terminating to a bridged appearance of an IAA-eligible station are not eligible for IAA.

- Last Number Dialed

Activation of the LND feature causes the last number dialed from the activating voice terminal to be redialed, regardless of the extension number used (primary or bridged call appearance).

- Leave Word Calling

A LWC message left by a user on a bridged call appearance leaves a message for the called party to call the primary extension number assigned to the bridged call appearance.

When a user calls a primary extension, and activates LWC, the message is left for the primary extension, even if the call was answered at a bridged call appearance.

LWC messages left by the primary user can be canceled by a bridged appearance user (for example, a secretary can cancel a LWC message left by a boss).

- Personal Central Office Line

- Single-line voice terminals

A single-line primary terminal cannot be a member of a PCOL group.

- Multiappearance voice terminals

If a user is active on his or her primary extension number on a PCOL call, bridged call appearances of that extension number cannot be used to bridge onto the call. The call can only be bridged onto the call if another voice terminal is a member of the same PCOL group and has a PCOL button.

- Preference

Ringling Line Preference selects an alerting bridged appearance; Idle Line Preference does not.

- Priority Calling

The primary terminal user or the bridging user can make a priority call. If a priority call is made to an idle terminal, the primary terminal and all bridging users are alerted by priority alerting.

A user cannot use an abbreviated dialing FAC after using a priority calling FAC.

- Privacy-Manual Exclusion

Exclusion prevents any other user from bridging onto the call. Activation of exclusion by any user (primary or bridged appearance) before placing a call, prevents any other user from bridging onto the call. Activation of exclusion by any user active on a call, while the primary user and/or any other bridging users are active on the call, drops all other users from the call (including the primary user), leaving only the activator and the calling/called party on the call.

- Redirection Notification (multiappearance voice terminals only)

Redirection Notification is not provided at stations with a bridged appearance of a primary extension number unless Ringing — Abbreviated and Delayed is administered to give notification.

- Ringback Queuing

Ringback Queuing is not provided on calls originated from a bridged call appearance. However, after the principal user of the bridged extension has activated Ringback Queuing, the resulting callback call alerts at bridged appearances as well as at the principal user's station. The call can be answered from the primary user's station or from any bridged appearance.

- Ringer Cutoff (multiappearance voice terminals only)

Ringer Cutoff prevents any nonpriority (or nonintercom) incoming call from ringing at that station. This is independent of whether the call is to the station's primary extension or to any of the bridged appearance's' extensions.

- Ringing — Abbreviated and Delayed

See Ringing — Abbreviated and Delayed, for other bridged appearance alerting options.

- Service Observing

The terminal user or bridging user can bridge onto a service observed call at any time. If the terminal is being service observed and an incoming call is answered by the bridging user, the call is not observed unless or until the terminal user bridges onto the call. Conversely, if the bridging user is being service observed and an incoming call is answered by the terminal user, the call is not observed unless or until the bridging user bridges onto the call.

If the bridging user activates Service Observing using a bridged appearance, Service Observing is activated for the bridging user.

- Terminating Extension Group

TEG calls to the primary extension do not ring at the associated bridged appearances. TEG calls cannot be answered or bridged onto from a bridged appearance of the TEG member's primary extension. The primary terminal should not be assigned to a TEG.

- Transfer

- Single-line voice terminals

A call cannot be transferred by an analog station if more than one user is active on that call.

The primary terminal user, when no other bridges are active on the call, can transfer the call using normal single-line transfer procedures. Any attempt by a bridging user to bridge onto this call during a successful transfer attempt is denied (a standard denial response is returned to the bridged appearance).

An analog bridging user, alone on a bridged call, can transfer the call, using normal transfer procedures. Any attempt by the primary terminal user to bridge onto this call during a successful transfer attempt is ignored; and any attempt to bridge on by a bridging user is denied.

If the bridging user has no other available bridged appearances of the primary extension (other than the one he or she is currently on), the bridging user, after pressing the conference/transfer button, must select a call appearance to be used for the transfer, before dialing the number.

- Multiappearance voice terminals

If the bridging user has at least one available bridged appearance of the primary extension (other than the one he or she is currently on), the system automatically selects a bridged call appearance for the transfer when the conference/transfer button is pressed.

You can administer the system to automatically select the first idle appearance if there is no idle appearance with an extension matching the extension that is transferring the call.

If the primary user and the bridged user are both on the call when one user transfers the call, the user performing the transfer becomes the controlling user for the participation of both users on the conference. The controlling user is immediately dropped from the call. When the noncontrolling user hangs up, the appearance goes on soft hold. In this case, one of two things must occur to disassociate the appearance from the call: all other parties on the call hang up, or the controlling user rejoins the call and hangs up again.

## 4 Basic Features

### *Bridged Call Appearance*

Page 4-127

- Videophone 2500 (single-line voice terminals)

A user may not use an analog bridge to a Videophone 2500 principal that is on a video call.

- Voice Message Retrieval

A voice message to the primary extension can be retrieved on a bridged appearance by the bridged appearance user. If a security code is required to retrieve the message, the bridging user must use the security code of the primary terminal.

- Voice Paging

The use of Voice Paging automatically invokes exclusion. Therefore, interactions for this feature are the same as for Privacy-Manual Exclusion.

## Bulletin Board

---

The bulletin board is a place on the switch where you can post information and receive messages from other switch administrators, including Lucent Technologies personnel. Anyone with appropriate permissions can use the bulletin board for everyday messages. In addition, Lucent Technologies personnel can leave high-priority messages, which are displayed on the first 10 lines of the bulletin board.

This feature is not intended as a substitute for existing escalation procedures, but rather as an aid to your existing procedures.

### How to administer Bulletin Board

---

#### Required forms

---

| Form                          | Field  | Page                 |
|-------------------------------|--|----------------------|
| Command Permission Categories | <ul style="list-style-type: none"><li>■ Display Admin and Maint Data</li><li>■ Administer Features</li></ul> | <a href="#">2-12</a> |
| Bulletin-Board                | <ul style="list-style-type: none"><li>■ All</li></ul>  | <a href="#">5-56</a> |

### Detailed description

---

Whenever you log in to the system, the system alerts you to any messages on the bulletin board and the date of the last-entered message. In addition, if a Lucent Technologies employee enters a high-priority message while you are logged in, you receive notification the next time you enter a command. This message disappears after you enter any command, and recurs at login until the high-priority messages are taken out.

The bulletin board provides three pages of message space. You can write on any available line other than the high-priority lines.

It is your responsibility to maintain the bulletin board. If the bulletin board is at 80% or more capacity, an additional message appears at login indicating how full the bulletin board is (for example, 86%). If the bulletin board is full, any new messages overwrite old messages.



## **Considerations**

---

- Only users with init or inads logins can add or edit high-priority messages.
- Only one user can change a message at a time.
- The bulletin board does not lose information during a system reset at level 1 or level 2. If you save translations, the information can be restored if a system reset occurs at levels 3, 4, or 5.

## **Interactions**

---

None

## Busy Verification of Terminals and Trunks

---

Busy Verification of Terminals and Trunks (Verify) allows attendants and specified multiappearance voice-terminal users to make test calls to trunks, voice terminals, and hunt DDC and UCD groups. Attendants and multiappearance voice-terminal users can distinguish between a voice terminal that is truly busy and one that only appears busy because of some trouble condition. They can also use this feature to quickly identify faulty trunks.

### How to administer Busy Verification of Terminals and Trunks

---

#### Required forms

| Form                      | Field                               | Page                 |
|---------------------------|-------------------------------------|----------------------|
| Attendant Console         | ■ Feature Button Assignments        | <a href="#">5-35</a> |
|                           | — verify<br>— Display Language      |                      |
| Station (multiappearance) | ■ Button/Feature Button Assignments | <a href="#">6-14</a> |
|                           | — verify<br>— Display Language      |                      |

#### Detailed description

---

An attendant or multiappearance voice-terminal user can activate Busy Verify by pressing the Verify button. If they want to verify a voice terminal or hunt group, they enter an extension number. If they want to verify a trunk, they dial a trunk-access code, followed by the 2- or 3-digit number of the trunk-group member to be verified. If the trunk-group member number is less than 10, the system requires a leading zero (01 or 001 rather than 1).

#### NOTE:

For Release 5vssi/csi and later, the member number is a 2-digit number; for Release 5r and later, the member number is a 3-digit number.

After an attendant or multiappearance voice-terminal user has activated Busy Verification of Terminals and Trunks, the system checks the validity of the extension or trunk-access code and member number. If the number is not a voice-terminal extension, DDC/UCD group-extension, ACD split number, or trunk access code with a valid member number, the system denies Verify and returns intercept tone.

When you use Verify to check a valid voice-terminal extension (one that is in the dial plan and assigned to a station), the system initiates a priority call to that extension. [Table 4-35](#) describes the process.

**Table 4-35. Verification of a Voice Terminal**

| Terminal Status   | System Response   | Result   |
|---|---|--|
| Idle  | <ul style="list-style-type: none"> <li>■ Generates priority ringing at the voice terminal</li> <li>■ Processes the call as a normal station-originated or attendant-originated call</li> </ul>  | <ul style="list-style-type: none"> <li>■ Verification is complete.</li> <li>■ Anyone can place a call to the voice terminal.</li> </ul>                        |
| Active on a call and has an idle call appearance                                  | <ul style="list-style-type: none"> <li>■ Generates priority ringing at the first idle appearance</li> <li>■ Processes the call as a normal attendant-originated call</li> </ul>   | <ul style="list-style-type: none"> <li>■ Verification is complete.</li> <li>■ Anyone can place a call to the voice-terminal extension.</li> </ul>              |
| Active on a call and has no idle call appearances or has only one line appearance | <ul style="list-style-type: none"> <li>■ Bridges the attendant onto the call</li> <li>■ Generates a warning tone to all active parties and repeats the tone every 15 seconds while the attendant remains bridged onto the call</li> </ul> | <ul style="list-style-type: none"> <li>■ Verification is complete.</li> <li>■ The attendant can determine if the voice terminal is actually in use.</li> </ul> |
| Out of service  | <ul style="list-style-type: none"> <li>■ Generates reorder tone</li> </ul>  | <ul style="list-style-type: none"> <li>■ Verification is denied.</li> </ul>  |

When you use Verify to check a valid ACD split, UCD group, or DDC group, the system initiates a priority call to that group. (Valid in this case means the split or group is translated and at least one member is logged in.) [Table 4-36](#) describes the process.

**Table 4-36. Verification of an ACD Split, UCD Group, or DDC Group**

| Split or Group Member Status     | System Response   | Result   |
|----------------------------------|---|--|
| Available for an incoming call   | <ul style="list-style-type: none"> <li>■ Generates priority ringing at the member's voice terminal</li> <li>■ Processes the call as a normal attendant-originated call</li> </ul> | <ul style="list-style-type: none"> <li>■ Verification is complete.</li> <li>■ Anyone can place a call to the member's voice terminal.</li> </ul> |
| All activated Make Busy          | <ul style="list-style-type: none"> <li>■ Generates reorder tone</li> </ul>  | <ul style="list-style-type: none"> <li>■ Verification is denied.</li> </ul>  |
| Not available for incoming calls | <ul style="list-style-type: none"> <li>■ The system does not queue the call even if a queue is available.</li> <li>■ Generates reorder tone</li> </ul>                            | <ul style="list-style-type: none"> <li>■ Verification is denied.</li> </ul>  |

When you use Verify to check a valid trunk, the system checks the status of that trunk. (Valid in this case means the trunk is translated with members and is not in an out-of-service state.) [Table 4-37](#) describes the process.

**Table 4-37. Verification of a Trunk**

| Trunk Status                           | System Response   | Result   |
|--|---|--|
| The trunk is idle and incoming.        | <ul style="list-style-type: none"> <li>■ The system generates confirmation tone.</li> </ul>   | <ul style="list-style-type: none"> <li>■ Verification is complete.</li> <li>■ Anyone can use the trunk.</li> </ul> |
| The trunk is idle and outgoing.        | <ul style="list-style-type: none"> <li>■ The system generates dial tone.</li> </ul>   | <ul style="list-style-type: none"> <li>■ Verification is complete.</li> <li>■ Anyone can use the trunk.</li> </ul> |
| The trunk is busy with an active call. | <ul style="list-style-type: none"> <li>■ The system bridges the Verify originator onto the call.</li> <li>■ The system generates a warning tone to all active parties and repeats the tone every 15 seconds while the Verify originator remains bridged onto the call.</li> </ul> | <ul style="list-style-type: none"> <li>■ Verification is complete.</li> <li>■ The trunk is in use.</li> </ul>      |
| The trunk is out of service.           | <ul style="list-style-type: none"> <li>■ The system generates reorder tone.</li> </ul>  | <ul style="list-style-type: none"> <li>■ Verification is denied.</li> </ul>  |

## Considerations

---

- A busy verification cannot be made to an analog extension that is waiting to be answered at another extension. A call must be answered before it can be verified.
- If your country requires a tone other than 440 Hz, use the Intrusion feature rather than Verify to verify voice terminals.
- The system does not provide bridging when you verify UCD and DDC groups or RLTs.
- You cannot make outgoing test calls on DID trunks.
- You can verify an extension that is administered without hardware. In this case, the system generates reorder tone.
- If the system denies Verify for any reason other than those identified in [Table 4-35](#), [Table 4-36](#), or [Table 4-37](#), the system generates intercept tone or reorder tone.
- The system denies Verify for vector directory numbers.

## Interactions

---

- Automatic Callback

Once the called party in an Automatic Callback call hangs up, neither extension can be busy-verified until both the calling and called parties are connected or the callback attempt is canceled (by the activating party or by time-out of the callback interval).
- Call Coverage

Since the busy-verification call to an extension is originated as a priority call, the call does not go to coverage.
- Call Forwarding

Busy verification made to an extension with call forwarding activated, does not busy verify the forwarded-to extension. Only the called extension is busy verified.
- Call Waiting Termination

You cannot verify an extension that called an active station and is receiving call-waiting ringback tone unless the extension has an idle call appearance.
- Conference — Attendant and Terminal

The system denies busy verification of any extension involved in a conference call of more than five people.

## 4 Basic Features

### *Busy Verification of Terminals and Trunks*

Page 4-134

parties that does not have an available call appearance. However, the system does allow a busy verification of any extension involved in a conference call of 5 or fewer parties. The system also denies busy verification of a trunk on a 6-party call.

- Data Privacy

Busy verification is denied if it would cause a bridging attempt on a voice terminal that has activated Data Privacy.

- Data Restriction

The system denies Verify if Data Restriction is active on a call, and a busy verification bridging attempt is made on that call.

- Hold

Busy verification of a multiappearance voice terminal is denied if all call appearances have calls on hold.

- Individual Attendant Access

An attendant cannot make a busy verification of another individual attendant console or of the attendant group.

- Loudspeaker Paging Access

The system denies busy verification if the voice terminal or trunk to be verified is connected to paging equipment.

- Transfer

Once the originator of busy verification has bridged onto a call, any attempt to transfer the call is denied until the originator drops from the call.

- Voice Terminal Origination Restriction

A voice terminal that is origination restricted can be assigned a Busy Verify button. However, the button cannot be used.

- Voice Terminal Termination Restriction

The system denies busy verification of voice terminals that are termination restricted.

## Button View

---

Button View allows users to view, on the terminal's display, the contents of any feature button. After the user presses the btn-view feature button or the BtnVu softkey, and a specific feature button, they see the feature name and any auxiliary data. These displays are helpful for users who want to see what is on their administered feature buttons. The terminal stays in the Button View mode to allow the user to view multiple features until:

- The user presses the Exit button.
- Five seconds expires since the last feature button was pressed.

This feature works on any 6400-, 7400-, or 8400-series voice terminal that has at least a 24-character display. Button View is an enhancement to the existing "View" softkey or "stored-num" feature button functionality, which only works on abbreviated dialing and autodial buttons and does not display feature names.

See *6400-Series Single-Line Telephone User's Guide (555-230-738)* and *6400-Series Multi-Line Telephone User's Guide (555-230-739)* for more information about user interactions.

### How to administer Button View

---

For new terminals and stations, use the **add** command to add the station and to administer a btn-view feature button for this feature. For systems upgrading, the Button View functionality is a default softkey for 6400-series display sets.

There can only be one Button View button assigned to each terminal; however, there is no limit on the number of Button View buttons per system, allowing for memory constraints.

### To administer user-defined language for displayed messages

Use the Change Display-Messages View-Button form to administer user-defined language. If the displayed language is set to "user-defined" for any user in the system, change the translation for each "user-defined" message to the language that the user requests.

1. Use the **change display-messages view-button** command to access the 8-page Change Display-Messages View-Button form.
2. Change the translation for each "user-defined" message to the language that the user requests.

### Interactions

---

None

## Call Charge Information

---

DEFINITY ECS provides two ways to know the approximate charge for calls made on outgoing trunks:

- Advice of Charge — for ISDN trunks  
Advice of Charge (AOC) collects charge information from the public network for each outgoing call. Charge advice is a number representing the cost of a call; it is recorded as either a charging or currency unit.
- Periodic Pulse Metering — for non-ISDN trunks  
Periodic Pulse Metering (PPM) accumulates pulses transmitted from the public network at periodic intervals during an outgoing trunk call. At the end of the call, the number of pulses collected is the basis for determining charges.

Call-charge information helps you to account for the cost of outgoing calls without waiting for the next bill from your network provider. This is especially important in countries where telephone bills are not itemized. You can also use this information to let employees know the cost of their phone calls, and so encourage them to help manage the company's telecommunications expenses. Note, however, that you cannot necessarily use this information to dispute telephone bills with the network provider.

You need to request either AOC or PPM service from your network provider. In some areas, your choice may be limited. Your Lucent Technologies representative can help you determine the type of service you need.

### NOTE:

This feature is not offered by the public network in some countries, including the US.

## Charge Display and CDR

DEFINITY ECS provides two ways for you to view call-charge information: on a voice-terminal display or as part of the Call Detail Recording (CDR) report.

From a voice-terminal display, you can see the cost of an outgoing call, both while the call is in progress and at the end of the call. If you want end users to control when they view this information, you can assign a display button that they can press to see the current call charges. If you want call charges to display automatically whenever a user places an outgoing call, you can set `Automatic Charge Display` to `y` on the user's Class of Restriction (COR) form.



## How to administer AOC (ISDN networks)

### Required forms

| Form                 | Field                            | Page                  |
|----------------------|----------------------------------|-----------------------|
| ISDN-PRI Trunk Group | ■ Charge Advice                  | <a href="#">7-219</a> |
|                      | ■ Service Type                   |                       |
|                      | ■ Supplementary Service Protocol |                       |
|                      | ■ CDR Reports                    |                       |

- The `Charge Advice` field must contain one of the following values.
  - `Automatic` — Use this only if your public network sends AOC information automatically.
  - `End-on-request` — Use this if DEFINITY ECS must request charge information with each call, and you want to receive only the final call charge.
  - `During-on-request` — Use this if DEFINITY ECS must request charge information with each call, and you want charges to display during and at the end of a call.
- In the `Service Type` field, enter **public-ntwrk**.

## How to administer PPM (non-ISDN networks)

### Required forms

| Form                                 | Field                                     | Page                  |
|--------------------------------------|---|-----------------------|
| Any of the Trunk Groups listed below | ■ Direction                               | <a href="#">7-115</a> |
|                                      | ■ CDR Reports                             |                       |
|                                      | ■ Analog PPM                              |                       |
|                                      | ■ Frequency                               |                       |
|                                      | ■ Outgoing Glare Guard timer              |                       |
| — CO                                 |   | <a href="#">7-168</a> |
| — DIOD                               |   | <a href="#">7-183</a> |
| — FX                                 |   | <a href="#">7-193</a> |
| — PCOL                               |   | <a href="#">7-246</a> |
| — WATS                               |   | <a href="#">7-268</a> |
| — DS1 Circuit Pack form              |   | <a href="#">7-79</a>  |
| — DS1 Circuit Pack form              | ■ Received Digital Metering Pulse Minimum | <a href="#">7-79</a>  |
|                                      | ■ Received Digital Metering Pulse Maximum |                       |
|                                      | ■ Received Digital Metering Pulse Value   |                       |

- Direction must be either **two-way** or **outgoing**.
- If you administer a PCOL trunk, set the `CDR Reports` field to **y**.
- PPM transmissions can occur up to five seconds after the call is dropped. In the `Outgoing Glare Guard Timer` field, enter a value large enough to account for this.

## How to administer for CDR reports

### Required forms

| Form                             | Field         | Page                  |
|----------------------------------|---------------|-----------------------|
| ISDN-PRI Trunk Group<br>(page 1) | ■ CDR Reports | <a href="#">7-219</a> |
| CDR System Parameters            | ■ All         | <a href="#">5-63</a>  |

- Primary (or Secondary) Output Format field must be one of the following types.
  - Customized — You must also include either the ISDN-CC or PPM fields in your record design. If you use both types of call-charge information, you need both fields.
  - Expanded (Enhanced 24-word standard ASCII)
  - Int-direct
  - Int-ISDN (International ISDN expanded)
  - Int-process
  - Unformatted (Enhanced 24-word standard ASCII)
- If you want call charges to restart at 0 for calls that are forwarded or transferred, administer Outg Trk Call Splitting.

## How to administer for call charge display

### Required forms

| Form                                 | Field                             | Page                  |
|--------------------------------------|-----------------------------------|-----------------------|
| Trunk Group<br>(page 2)              | ■ Charge Conversion               | <a href="#">7-115</a> |
|                                      | ■ Decimal Point                   |                       |
|                                      | ■ Currency Symbol                 |                       |
|                                      | ■ Charge Type                     |                       |
| Feature-Related<br>System Parameters | ■ Charge Display Update Frequency | <a href="#">5-123</a> |
| Station                              | ■ Display or Feature Buttons      | <a href="#">6-14</a>  |
|                                      | — disp-chrg                       |                       |
| Class of Restriction                 | ■ Automatic Charge Display        | <a href="#">5-72</a>  |
| CDR System Parameters                | ■ Outg Trk Call Splitting         | <a href="#">5-63</a>  |
| Language Translations                | ■ Call Charge                     | <a href="#">5-193</a> |

## Instructions

### Trunk Group form

The following fields are optional. If you want call charges to appear as currency, complete these fields as indicated.

- In the `Charge Conversion` field, enter the value of a charge unit in terms of currency. DEFINITY ECS multiplies the number of charge units by the value of this field, and displays this as a currency amount. Valid values are **1–64,500**. Default is **1**.
- In the `Decimal Point` field, enter **comma**, **period**, or **none**. Entering comma or period in this field divides the charge value by 100. Default is **none**.
- In the `Currency Symbol` field, enter the symbol you want to appear in front of the charge amount. Valid values are any characters, to a maximum of 3, that you can enter from your keyboard. Default is blank.
- In the `Charge Type` field, enter a text string to describe the charges. This field appears on a user's voice-terminal display. Default is **units**.

### Feature-Related System Parameters form

- If the duration of a call is less than the Charge Display Update Frequency, the display will not automatically show charge information. To see charge information for a call, the user must have a disp-chrg button and must press the button before the call drops.

## Station form

- In an available `Display Button Or Feature Button` field, enter **disp-chrg** to give this user the ability to control the charge display. You must administer a disp-charge button for attendant consoles to display charges.

## Detailed description

The availability of AOC and PPM varies from one country to the next.

- In some countries, the public network sends call-charge information only at the end of a call. In others, the public network sends information during a call as well.
- In some countries, AOC information is received automatically for each call. In others, the system must request AOC information for each call.

## CDR Output

The `ISDN Call Charge` or `PPM` field contains the last cumulative charge received from the network. If `Call Splitting` or `Attendant Call Recording` is enabled, and a call has been transferred for the first time, the `ISDN Call Charge` field contains the cumulative charge most recently received from the network.

For all subsequent transfers, the `ISDN Call Charge` field contains the difference between the cumulative charge most recently received and the value generated in the previous CDR record for the same call.

A zero appears in the `Call Charge` field when: no AOC information is received; a value of zero is the last charge information received; or the outgoing trunk group is not administered for AOC or PPM.

## Considerations

### Attendant consoles

Automatic Charge Display Mode does not apply to attendant consoles. The attendant must always press a button to enter display mode.

### Performance impact

Call Charge Information can impact system performance in several ways. The information coming in over ISDN trunks takes up bandwidth, and reduces the maximum amount of traffic the ISDN D-channel can handle. This is especially true in countries such as Germany and France, where the network sends charging information updates as often as every 3 to 10 seconds for each active international call.

The number of sets that display charge information and the frequency of updates also affect performance. Normally, the update frequency should match the average rate at which call charge updates are received from the public network.

 **CAUTION:**

*Updating displays too frequently can cause unnecessary system performance degradation. If performance slows to an unacceptable rate, you may need to lengthen the amount of time between updates.*

## Button operations

If you administer a button for charge display, the display-set user can press the disp-chrg button at any time during the call to see the current charges. If your public network sends charge information only at the end of a call, display-set users must have this button and press it just before they hang up. After the call drops, the charge will appear.

## Other display functions

If a user invokes the elapsed-timer display, the timer may overwrite part of the charge display. If the user has a local directory (Dir button), and presses this button while a call is in charge display mode, the call-charge information will overwrite the directory any time an update comes in. To avoid this, the user must press Exit or Normal.

## Interactions

---

- **Attendant Features**

Attendant consoles cannot have automatic charge display. If you want the attendant to see call charges, you must assign a disp-chrg button to the attendant console. If the attendant moves to transfer an outgoing call, the display returns to normal mode. If the transfer does not complete, or the call remains at the attendant station for whatever reason, the attendant must press the disp-chrg button again to view call charges.

- **Automatic Incoming Call Display**

When a call alerts on another line appearance, the display returns to normal mode for a short time to show the identity of the caller. The user must press disp-chrg again to view call charges, or if automatic charge display is enabled, must wait for the Charge Update Frequency Timer to expire.

- **Bridged Appearance**

If a user makes a call using a bridged appearance, the call charges display on the voice terminal from which the call is made. If that voice terminal has Automatic Charge Display as part of its COR, the charges will

appear automatically. The actual charge for the call appears on the CDR report as if the call had been made from the principal's extension, not the bridged appearance.

- Call Coverage or Forwarding — Off Net

Call charges for a call to a station whose calls are redirected over a public-network trunk are charged to the called station, not the calling station. However, if the call is placed from an internal station that has charge display capability, the caller will see the charges for the redirected call.

- Call Park

When a user parks a call, the display mode returns to Normal. If a user retrieves a parked, outgoing call from another display station, the display on that set shows the current call charges if the user presses a disp-chnrg button, or if the user's COR allows Automatic Charge Display. If call splitting is enabled, the display shows the charges accumulated since the user unparked the call.

- Call Transfer

For Advice of Charge, if a transferred call is routed over a public-network ISDN-PRI trunk group, AOC administration for the outgoing trunk group controls whether AOC information is requested or recorded for the call. If two or more outgoing trunks are connected together via trunk-to-trunk transfer, the DEFINITY ECS may receive AOC information from the network for each outgoing trunk involved in the call.

- CDR Adjuncts

DEFINITY ECS does not tandem AOC information through a private network to other switches. Therefore, the CDR adjunct that records AOC information must receive its input from DEFINITY ECS directly connected to the public network.

- CDR Call Splitting

If you use CDR Call Splitting for outgoing trunks, each time a call is transferred, the system generates a separate record. Attendant Call Recording, a form of Call Splitting, generates a CDR record when an attendant drops from a call. Incoming Trunk Call Splitting has no effect on charge information.

If you rely on Call Splitting or Attendant Call Recording, you should request call charge information during the call. However, for AOC, this increases message activity on the signaling channel and reduces Busy Hour Call Capacity of the DEFINITY System.

In some countries, or with specific protocols, AOC information during a call is not available. In this case, you can use the Elapsed Time in the CDR records to allocate the charges among the parties on the call.

You must use CDR Call Splitting if you want the charge display to restart at 0 when a call is transferred.

- Centralized Attendant Services

In any configuration where a branch system has no direct connection to the public network, the private network does not pass call-charge information to these branches.
- Conference

If a user adds a third party to a call in charge-display mode, the display returns to normal. Call charges will not appear as long as there are more than two parties on the call.
- Distributed Communications System (DCS)

In any configuration where a branch system has no direct connection to the public network, the private network does not pass call-charge information to these branches.
- Electronic Tandem Network (ETN)

In any configuration where a branch system has no direct connection to the public network, the private network does not pass call-charge information to these branches.
- Enhanced Voice Terminal Display

If you have Enhanced Voice Terminal Display enabled, you can use the expanded character set to enter translations for the `Charge Type` and `Call Charge` fields.
- Hold

If a user places a call on hold, the display returns to normal mode. The user must press `disp-chrg` again to view call charges, or if automatic charge display is enabled, must wait for the `Charge Update Frequency Timer` to expire.
- Last Number Dialed

Users can view the dialed number while active on a call by pressing the `stored-numb` button, then the `last-numb` button. To view call charges again, the user must then press the `disp-chrg` button, or (if `Automatic Charge Display` is part of the user's `COR`) the `Normal` button.
- QSIG

In any configuration where a branch system has no direct connection to the public network, the private network does not pass call charge information to these branches.
- Software updates — call preserving

In the event of a call-preserving software update, call charge displays for any active calls will stop, and no final charge information will be available. The CDR report will *not* contain records for calls active during a software upgrade.
- System Resets



If you perform a warm reset while calls are active with charge display, the charge display will freeze. To resume call charge updates, users must press the Normal button.

## Call Coverage

---

Call Coverage provides automatic redirection of calls to alternate answering positions in a Call Coverage path. Call Coverage allows you to:

- Establish coverage paths with up to 6 alternate answering positions
- Establish redirection criteria that govern when a call redirects
- Redirect calls to a local switch location
- Redirect calls to a location on another switch in a DCS network (see [“Distributed Communications System” on page 12-11](#) for more information)
- Redirect calls to a remote location
- Redirect calls based on time-of-day
- Allow users to change back and forth between two coverage choices (either specific lead coverage paths or time-of-day tables). Users may make these changes either an on- or off-site location

### How to administer Call Coverage

---

#### Required forms

| Form                               | Field   | Page                  |
|------------------------------------|---|-----------------------|
| Coverage Answer Group <sup>1</sup> | ■ All   | <a href="#">5-92</a>  |
| Coverage Path                      | ■ All   | <a href="#">5-94</a>  |
| Feature Access Code (FAC)          | <ul style="list-style-type: none"> <li>■ Send All Calls Activation and Deactivation</li> <li>■ Transfer into AUDIX</li> </ul>   | <a href="#">5-113</a> |
| Feature-Related System Parameters  | <ul style="list-style-type: none"> <li>■ Coverage Subsequent Redirection/CFWD No Answer Interval</li> <li>■ Coverage — Caller Response Interval (seconds)</li> <li>■ Keep Held SBA at Coverage Point</li> <li>■ Coverage of Calls Redirected Off-Net Enabled</li> </ul> | <a href="#">5-123</a> |

*Continued on next page*

**Required forms — Continued**

| Form   | Field   | Page                                   |
|--|---|--|
| Hunt Group   | ■ Coverage Path   | <a href="#">5-158</a>                  |
|  | ■ Redirect to VDN   |  |
| Remote Call Coverage Table   | ■ All   | <a href="#">5-263</a>                  |
| Station<br>(principals — the one to whom the call is first directed)                 | ■ Coverage Path Redirect Notification                                 | <a href="#">6-4</a>                    |
|  | ■ Coverage Msg Retrieval Permission                                   |  |
|  | ■ Button/Feature Button Assignments<br>— send-calls (Type: __Grp: __) |  |
| Station (multiappearance)<br>(covering user — the one to whom the call redirects)    | ■ Button/Feature Button Assignments<br>— consult                      | <a href="#">6-14</a>                   |
|  | — cov-cback   |  |
|  | — goto-cover  |  |
|  | — send-calls (Type: __Grp: __)  |  |
| Station (multiappearance)<br>(where users place calls that can redirect to coverage) | ■ Button/Feature Button Assignments<br>— goto-cover                   | <a href="#">6-14</a>                   |
|  |   |  |
| Terminating Extension Group <sup>1</sup>   | ■ Coverage Path   | <a href="#">5-295</a>                  |
| Time of Day Coverage Table   | ■ All   | <a href="#">5-298</a>                  |
| Trunk Group  |   |  |
|  | — APLT  | ■ Internal Alert <a href="#">7-156</a> |
|  | — ISDN-PRI  | ■ Internal Alert <a href="#">7-219</a> |
| — Tie  | ■ Internal Alert <a href="#">7-262</a>                                |  |

1. Not for Remote Call Coverage

**Detailed description**

When a call meets the redirection criteria of the principal, the call attempts to route to one of up to 6 points in the coverage path. If no coverage points are available, the call may revert to the called principal or group. If any point in the path is available, the call either rings the individual voice terminal or member of a

group specified for that point or queues on the group. Once a call is ringing or queued at any point in a coverage path, the call never reverts to the called principal or group, or to the previous point. A call remains at a coverage point for the Coverage Subsequent Redirection interval. At the end of this interval, the call attempts to route to any remaining points in the coverage path. If no other point is available to accept the call, the call remains queued or continues ringing the current coverage point.

## Coverage Path

A Call Coverage path is a list of up to six alternate answering positions (covering users/points) that are accessed, in sequence, when the called party or group is not available to answer the call.

You can assign any of the following entities a coverage path so they are eligible to have calls redirected to coverage:

- ACD split
- Agent LoginID
- PCOL group
- TEG
- Hunt group
- Voice terminal (on-net or off-net)

You establish the coverage paths and set the redirection criteria. If a coverage path is not assigned to a particular facility, calls are not redirected from that facility, unless another feature is assigned. A coverage path can include any of the following:

- Announcement
- Attendant group
- AUDIX
- Coverage answer group
- Hunt group
- Public network number (off-net)
- VDN
- Voice terminal (on-net or off-net)

DEFINITY ECS allows for multiple coverage paths. However, for any particular call only one coverage path is used. The “lead” coverage path is the first coverage path in a chain that is considered when a call redirects to coverage. The chain is defined in the `Next Path Name` field on the Coverage Path form.

When a call redirects to coverage, the lead coverage path at that time is checked to determine whether its coverage redirection criteria match the call status. If there is a match the lead coverage path is used. If the lead path does not match, the system moves down the path chain until it finds a coverage path with redirection criteria that matches the call status. If the chain is exhausted before the system finds a match, the call does not redirect to coverage. Once a coverage path is selected, it is used exclusively through the duration of the call.

You can assign lead coverage paths directly in the *Coverage Path 1* or *Coverage Path 2* fields on the appropriate forms. For example, to assign a lead path for a TEG, set the *Coverage Path* fields on the Terminating Extension Group form. You can also assign the lead paths indirectly by assigning a Time-of-Day Coverage Table to the *Coverage Path 1* and *Coverage Path 2* fields. Then, the system selects the lead path according to the time of day.

## Call redirection criteria

Redirection criteria determine the conditions under which a call redirects from the principal (called) extension to the first position in the coverage path. The criteria and conditions that apply are as follows:

- Active

Redirects call-to-call coverage immediately when the principal is active on at least one call appearance. For a voice terminal with only one appearance or a single-line extension, assign the Busy criterion (discussed below) instead of the Active criterion.

- Busy

Redirects calls to coverage when all available call appearances at the principal extension are in use. For multiappearance voice terminals, one call appearance can be reserved for outgoing calls or incoming priority calls (discussed later). The remaining assigned call appearances are available for other incoming calls. An incoming call (other than a priority call) redirects to coverage only when all of these unreserved call appearances are in use. If at least one unreserved call appearance is idle at the principal extension, the call remains at that idle appearance.

A Terminating Extension Group (TEG) is considered busy if any voice terminal in the group is active on a call.

Each voice terminal in a UCD or DDC group must be active on at least one call appearance for the call to redirect to coverage. If any voice terminal in the group is idle the call directs to that voice terminal. If no voice terminal is available, the call can queue if queuing is provided. If queuing is not provided, then the call routes to coverage. If the queue is full or all agents are in an auxiliary state, the group is considered busy and the call routes to coverage. Queued calls remain in queue for the Don't Answer Interval.

A call will not cover to a hunt group if no agents are logged in, or if all agents are in AuxWork mode.

- Don't Answer  
Redirects calls to coverage if unanswered during the assigned Don't Answer Interval. A call rings for the Don't Answer Interval and then redirects to coverage.
- Cover All Calls  
Redirects all incoming calls to coverage. This criterion has precedence over any other criterion previously assigned.
- Send All Calls/Go to Cover  
Allows users to activate Send All Calls or Go to Cover as an overriding coverage criteria. This redirection criteria must be assigned before a user can activate Send All Calls or Go to Cover (discussed later).
- No Coverage  
Occurs when none of the above criteria are assigned. Calls redirect to coverage only when the principal has activated Send All Calls or the caller has activated Go to Cover. Both of these overriding criteria are discussed later.

Redirection criteria can be assigned in combinations. For example, you can combine Active/Don't Answer and Busy/Don't Answer. Other combinations are not possible or do not provide any useful function. For example, Active/Busy does not accomplish anything. A busy voice terminal is always active.

Redirection criteria are assigned separately for internal and external calls. By linking the coverage paths, Busy/Don't Answer can be assigned for internal calls and Active can be assigned for external calls. Similarly, Busy/Don't Answer can apply for external calls and No Coverage can apply for internal calls. In the latter case, internal calls remain directed to the called terminal or group.

All calls extended by the attendant are treated as external.

### Features that override Call Coverage

Some system features override Call Coverage criteria; they are checked before the redirection criteria are checked. These features are:

- Call Forwarding All Calls  
Call Forwarding provides a temporary override of the redirection criteria, if Send All Calls is not active. The call attempts to complete to the forwarded-to extension before redirecting to coverage. If the principal's redirection criteria are met at the forwarded-to extension, the call redirects to the principal's coverage path.
- Go to Cover  
Go to Cover allows users, when calling to another internal extension, to send the call directly to coverage. This is optionally assigned to a button on a voice terminal and is activated by the internal calling party. Use of Go to Cover is discussed later.

- Send All Calls

Send All Calls allows principals to temporarily direct all incoming calls to coverage regardless of the assigned redirection criteria. For example, if the redirection criteria are administered so that no calls redirect, all incoming calls terminate at the principal's voice terminal unless Send All Calls is activated. Also, Send All Calls allows covering users to temporarily remove their voice terminals from the coverage path.

Send All Calls is activated by pressing the Send All Calls button or by dialing the Send All Calls access code. It is deactivated by pressing the button a second time or by dialing the deactivate code.

A user who is not assigned a coverage path with Send All Calls or Cover All Calls redirection criteria, cannot activate Send All Calls.

Any attempt to activate Send All Calls is denied if the currently active coverage path does not allow it in its coverage criteria. However, if the user activates Send All Calls for a coverage path that does allow it, and then the user's coverage path is changed by the system to a coverage path that does *not* allow Send All Calls:

- The Send All Calls button remains lit.
- Send All Calls automatically resumes when the user is changed back to a coverage path that does allow it.

If a user has activated Send All Calls and has only one coverage point, and receives a call from that coverage point, the call rings silently at the user's voice terminal, because the coverage point is already on the call.

Send All Calls is similar to Cover All Calls, discussed previously. However, you set Cover All Calls and it is used for screening the principal's call. The principal may or may not be rung on an incoming call, depending on how this function is assigned. Send All Calls is controlled by the principal and is normally used when the principal is away temporarily.

TEG calls are not affected by Send All Calls.

- Send Term

Send Term is the Send All Calls equivalent for TEG. Since a TEG cannot be in a coverage path, Send Term applies only to a directly called TEG.

### Conditions that override Call Coverage

Call Coverage provides redirection of calls from the called principal or group to alternate answering positions when certain criteria are met. Certain provisions allow calls to direct to and/or be answered by the principal even though the redirection or overriding criteria are met. These provisions are:

- If no answering positions are available in the Coverage Path, the call rings the called voice terminal, if possible; otherwise, the calling party receives busy tone. This applies even if the Cover All Calls redirection criterion or the Send All Calls overriding criterion is active.

- Similarly, calls directed to a UCD or DDC group are queued, if queuing is available, when no group members are available to answer the call. The call remains in queue for the Don't Answer Interval before routing according to the coverage path. If no points on the path are available, the call remains in queue. The worst case is when group queuing and the coverage points are both unavailable. In this case, the caller receives busy tone or ringback, depending on the type of trunk carrying the call.
- If the redirection criterion is Active or Cover All Calls, a called principal can receive a redirection notification signal (a short burst of ringing) when the call routes to coverage. (Redirection Notification is optional on a per-terminal basis.) Note that in the Active, Cover All Calls, and Don't Answer cases, the principal could answer the call. Busy means no call appearances are available to answer the call. Redirected calls maintain an appearance on the called voice terminal, if possible. The call appearance status lamp flashes to indicate an incoming call before the call redirects. When the call does redirect, the status lamp lights steadily. The user can answer the call by pressing the call appearance button. If the call has already been answered, the principal is bridged onto the call. This provision is called Temporary Bridged Appearance.
- A voice-terminal user can use Directed Call Pickup to pick up a principal's call or a call alerting at a coverage point. Directed Call Pickup allows a voice-terminal user to answer an alerting call from any station on the DEFINITY ECS. That is, the alerting and answering stations do not need to be members of the same Call Pickup group. You enable and disable Directed Call Pickup on a system-wide base. However, permission to use the feature can be allowed or disallowed based on COR.
- Priority Calling, Dial Intercom, and Automatic Intercom Calls always route directly to the principal's voice terminal until the calling party activates Go to Cover. These calls take precedence over the redirection criteria and can seize the call appearance normally reserved for outgoing calls, if no other call appearances are available.

An internal calling party is informed that a call is redirecting to coverage by a single, short burst of ringing, called a Call Coverage tone. This tone is followed by an optional period of silence, called a Caller Response Interval. This interval allows the calling party time to decide what to do: hang up or activate Leave Word Calling, Automatic Callback, or Go to Cover. Activating Go to Cover cancels the remaining interval.

## Covering-user options

For specific Call Coverage needs, the following options are available to voice-terminal users:

- Consult
  - Allows the covering user, by first pressing the Transfer button and then the Consult button, to call the principal (called party) for private consultation. These two actions place the caller on hold and establish a connection



between the principal and the covering user. If the principal wishes, the covering user can complete the conference and add the calling party to the conversation. Similarly, the call can be transferred to the principal. Consult calls use the Temporary Bridged Appearance maintained on the call, if there is one. If not, the Consult call seizes any idle call appearance. If there is no idle call appearance, the Consult call is denied.

- Coverage Callback

Allows a covering user, by pressing the Cover Callback button, to leave a message for the principal to call the calling party. Coverage Callback uses Implied Principal Addressing to infer both extensions so that the covering user does not have to dial either the principal's or the caller's number. The caller must be an internal caller. The principal receives no indication that the covering user handled the call.

Alternatively, if the covering user presses the Leave Word Calling button, a "call me" message is left for the principal. The principal calls the covering user to get the message. This method is used when an external call is received or when an internal caller wants to leave a message but is not available for a return call.

- Coverage Answer Group

A Coverage Answer Group can have up to eight members. When a call is redirected to a Coverage Answer Group, all voice terminals in the group ring simultaneously. Anyone in the group can answer the call. A Coverage Answer Group member already handling a group call is rung when another call is redirected to that Coverage Answer Group. If a Coverage Answer Group member is also a member of another Coverage Answer Group, he or she can also receive calls for the other group. A second call directed to a Coverage Answer Group lights a Coverage Incoming Call Identification (ICI) lamp.

- Coverage Incoming Call Identification

A Coverage ICI button can be assigned to multiappearance voice-terminal users without a display in a Coverage Answer Group.

The Coverage ICI status lamp identifies a call incoming to that Coverage Answer Group. If a Coverage Answer Group is assigned to more than one Call Coverage path, the path number cannot be identified. Likewise, if a given path is assigned to more than one principal, the individual principals cannot be identified. To provide unique path and principal identification, you must establish a unique path for each principal and a unique Coverage Answer Group to be included in the path. A second coverage call takes control of the Coverage ICI lamp and does not return control to the previous call when the second call is released.

## Time-of-Day Coverage

The Time-of-Day Coverage Table allows you to redirect calls to different lead-coverage paths at different times of the day and on different days of the week.

For example, an employee may want incoming calls to cover to a co-worker (office) during normal business hours, to cover to an off-net destination (home) in the early evening, and to cover to AUDIX at all other times. By specifying the appropriate lead-coverage paths in the Time-of-Day Coverage Table, the employee can have the call redirection flexibility shown in [Table 4-38](#). (If you were actually administering a Time-of-Day Coverage Table, you would provide the lead-coverage path numbers that redirect the calls to the employee's office, to their home, and to AUDIX.

**Table 4-38. Time-of-Day Call Redirection example**

| Day of the Week | Time 1<br>Directed To        | Time 2<br>Directed To         | Time 3<br>Directed To       | Time 4<br>Directed To        |
|-----------------|------------------------------|-------------------------------|-----------------------------|------------------------------|
| Monday          | 00:00<br>CovPath3<br>(AUDIX) | 08:00<br>CovPath1<br>(Office) | 17:30<br>CovPath2<br>(Home) | 20:00<br>CovPath3<br>(AUDIX) |
| Tuesday         | 00:00<br>CovPath3<br>(AUDIX) | 08:00<br>CovPath1<br>(Office) | 17:30<br>CovPath2<br>(Home) | 20:00<br>CovPath3<br>(AUDIX) |
| Wednesday       | 00:00<br>CovPath3<br>(AUDIX) | 08:00<br>CovPath1<br>(Office) | 17:30<br>CovPath2<br>(Home) | 20:00<br>CovPath3<br>(AUDIX) |
| Thursday        | 00:00<br>CovPath3<br>(AUDIX) | 08:00<br>CovPath1<br>(Office) | 17:30<br>CovPath2<br>(Home) | 20:00<br>CovPath3<br>(AUDIX) |
| Friday          | 00:00<br>CovPath3<br>(AUDIX) | 08:00<br>CovPath1<br>(Office) | 17:30<br>CovPath2<br>(Home) |                              |
| Saturday        | 00:00<br>CovPath3<br>(AUDIX) |                               |                             |                              |
| Sunday          | 00:00<br>CovPath3<br>(AUDIX) |                               |                             |                              |

Time is represented in 24-hour format and activation times are ascending from the earliest to the latest. There are no gaps in the activation times; the entire day is covered. If you do not assign a lead-coverage path to a specific time interval, there is no coverage from that time until the next activation time with an assigned lead-coverage path.

When a call arrives at a principal, the system queries for the lead coverage path in effect at that time and uses that information to determine call redirection. If call coverage is changed via administration *while the call is in progress*, the administration changes do not affect that call.

## Off-Net Call Coverage

Call Coverage allows for redirection of a call to a destination that is on the public network. The remote (off-net) number is administered on the Remote Call Coverage Table form and may have up to 16 digits including the FAC specifying ARS or AAR, to the outgoing trunk access code (TAC). Any coverage point in a coverage path can be an off-net destination.

When the Coverage of Calls Redirected Off-Net Enabled field on the Feature-Related System Parameters form is enabled:

- The system monitors off-net calls (call classification) and brings them back to the switch if they are not answered within the defined time interval. (You set this interval in the Coverage Subsequent Redirection/CFWD No Answer Interval field on the Feature-Related System Parameters form.) Calls also return to the switch if the system detects a call progress tone, such as busy or reorder. Answer Supervision by Call Classifier on the System-Parameters Customer-Options form must be **y**.
- A simulated bridge appearance is put on the principal and the green lamp is put in flashing mode; the principal can pick up the call at any time.
- The switch plays local ringback tone to the caller while the off-net call is being classified. That call classification is fast, but not instantaneous. If a call is answered off-net, it is possible that the first few syllables spoken after answer will be covered up by this local ringback tone.
- If any party on the call is on HOLD when the call routes off net, the off-net call reverts to a non-call classified state. It behaves in the same manner as off-net calls when Coverage of Calls Redirected Off-Net is not enabled.
- While an off-net call is undergoing call classification, any party who is not already on the call will be unable to bridge onto the call. Also, the originating party cannot conference anyone else onto the call or transfer the call to a new party. Once the call is answered off-net or the call is returned to the switch for further call processing, then these restrictions are removed.
- In some instances more than one call classifier may be monitoring an off net (coverage/forwarding) call. If the call is answered and for some reason one of the call classifiers fails to detect the answer, the call may be disconnected and redirected to further coverage treatment.

- DEFINITY ECS has no control over any redirection of the call that may take place at an off-net destination. However, further coverage treatment will be provided if the Coverage Subsequent Redirection/CFWD No Answer Interval expires before the call is answered off-net.

If the `Coverage of Calls Redirected Off-Net` field is *not* activated, the system does not monitor off-net calls and bring them back for additional call-coverage processing. In this case, once a call is directed to the remote call-coverage point, the principal is dropped from the call.

## VDN in a Call Coverage path

Assigning a VDN extension as the last point in a Call Coverage path allows the functionality of Call Vectoring to be applied to a coverage point. The programmable vector associated with the VDN effectively can provide great flexibility in call handling. The integration of the Call Vectoring and Call Coverage features can drive powerful AUDIX and Message Server applications.

For example, you can program the vector assigned to the VDN in the coverage path to queue a redirected call to a messaging split for call answer operation and to allow the caller to leave a message for the called principal. The same VDN can also be used to retrieve messages. The vector program may also be varied by time of day or split status to provide different types of coverage.

When a redirected call covers to a VDN, the principal's temporary bridged appearance is removed when vector processing begins. VDN override does not apply to calls that are redirected by Call Coverage.

When covered or direct calls are connected to AUDIX or a messaging split via call vectoring, the original reason for redirection and the called principal must be passed to the adjunct over the Switch Communication Interface (SCI) link. Also the VDN number must be entered (rather than the split extension) in the `Group Extension` field on the Hunt Group form.

Use of a VDN as a coverage point provides integration to Centralized Messaging. That is, the Distributed Communications System (DCS) message sent to the remote switch with AUDIX includes the original reason for redirection and called principal.

An administration change is required to allow an extension that is assigned as a VDN to be entered as the last point in the coverage path. See *DEFINITY Enterprise Communications Server Call Vectoring/EAS Guide* for more information.

## Extended User Administration of Redirected Calls

The Extended User Administration of Redirected Calls feature (also called telecommuting access) allows system users to change their lead-coverage path or their call-forwarding designated destination from any on-site or off-site location. See "[Extended User Administration of Redirected Calls](#)" on page 4-333 for more information on this feature.

## Measurements and reports

---

Three reports provide measurement information about Call Coverage:

- The Coverage Path Measurement Report describes coverage activity as it relates to the coverage paths.
- The Principal Coverage Measurement Report describes coverage activity as it relates to the principal extensions.
- The Call Detail Recording (CDR) shows the outgoing trunk calls.

For each report, a selection form lists the specific coverage paths or principal extensions to be measured. For more detailed information on these reports and their associated commands, see *DEFINITY Enterprise Communications Server Release 5 System Monitoring and Reporting*.

## Considerations

---

- Incoming tie-trunk calls can be administered as either internal or external and are redirected to Call Coverage accordingly.

## Guidelines and examples of Call Coverage

---

Call Coverage is an extremely flexible feature and allows several combinations of coverage points. To illustrate the usefulness of Call Coverage, three typical coverage arrangements are given below.

- Executive Coverage

Provides a principal with call redirection to covering users having a close working relationship with the principal. Because of the status of the principal, personalized answering should be provided. Also, the principal may or may not choose to answer his or her own calls.

Redirection of a principal's calls to a secretary is a typical example of this form of coverage. The secretary would be informed of the principal's daily schedule and other useful information such as the importance of certain calls. The secretary could provide personalized answering by answering calls with the principal's name.

If the secretary is unavailable to answer the coverage call for the principal, the call redirects to a backup answering position. Personalized answering should also be provided at the backup position.

- Middle Manager Coverage

Provides a group of principals with call redirection to one or more covering users (such as a secretary). The secretary should have some knowledge of the principal's daily schedule. A backup answering position should be provided in case the secretary is unavailable.

- General User Coverage

Provides less-personal coverage for a broader spectrum of users. Covering users typically consist of a group or pooled answering arrangement. Coverage calls may be distributed among the members of the answering group.

Following is an example of how to provide an Executive Coverage arrangement.

1. Determine if the secretary and backup position have a call display capability.
  - If so, Coverage Answer Groups are not required.
  - If not, establish a unique Coverage Answer Group for each one without a display. Specify only the applicable extension. The Coverage Answer Group contains only one member. Establish two groups, if required. Note that, if the secretary and/or backup answering position are in a Coverage Answer Group, each receives only one redirected call for the executive at any given time. Calls do ring a Coverage Answer Group member already busy on a call to the group. For frequently called executives, the secretary and possibly the backup answering position should have digital-display capability.
2. Establish a unique Call Coverage Path for the executive.
  - If the secretary screens calls, specify Cover All Calls as the redirection criteria.
  - If the executive answers calls, specify Active, Busy, Don't Answer, Active/Don't Answer, or Busy/Don't Answer as desired.
  - Specify the secretary and the backup position (or the Coverage Answer Groups containing the secretary's and backup position's extensions) as the coverage points in the path.
3. Optionally, specify a Send All Calls button on the executive's voice terminal. If someone else answers the executive's calls, the button is not needed.
4. Specify a Send All Calls button and a Consult button on the secretary's voice terminal. Specify a Coverage ICI button if the secretary does not have a call display. Send All Calls is needed if the secretary is unavailable for a period of time. Consult is needed to enable private consultation with

the executive during an established call. Coverage ICI is needed to identify the call as a call to the executive rather than a personal call to the secretary.

5. Specify a Consult button and a Coverage ICI button on the backup position's voice terminal for the same reasons that these buttons were specified for the secretary.

4 Basic Features  
 Call Coverage

**EXAMPLE 1 COVERAGE PATH FOR OUTSIDE CALLS**

call type - OUTSIDE

CRITERIA - busy, don't answer, and send all calls (when activated)

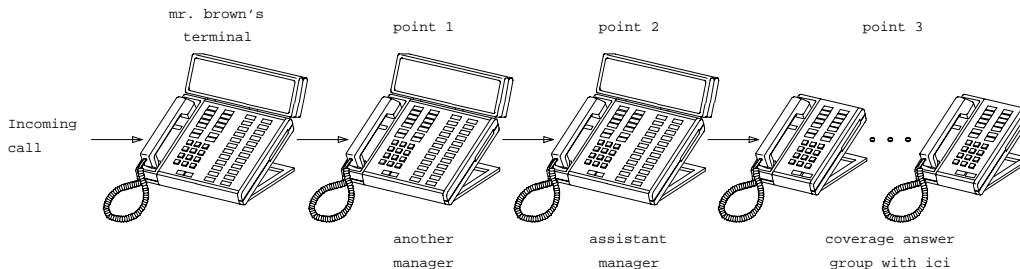

**EXAMPLE 2 COVERAGE PATH FOR INSIDE CALLS**

call type - INSIDE

criteria - BUSY AND DON'T ANSWER (SEND ALL CALLS NOT ACTIVATED)

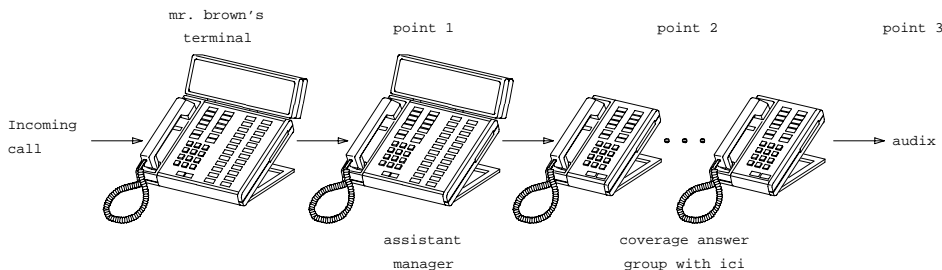

**EXAMPLE 3 COVERAGE PATH FOR INSIDE CALLS**

call type - INSIDE

criteria - SEND ALL CALLS ACTIVATED

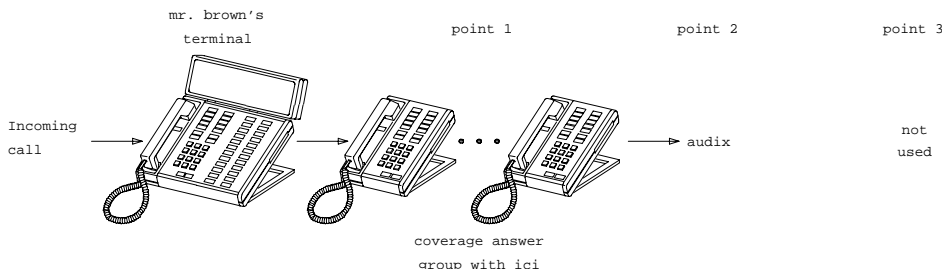

Figure 4-1. Coverage path examples



4 Basic Features  
 Call Coverage

```

                                COVERAGE PATH                                Page 1 of 1
                                Coverage Path Number: 1
                                Next Path Number: 2 Linkage 3

                                COVERAGE CRITERIA
                                Station/Group Status Inside Call Outside Call
                                Active?           n           n
                                Busy?             n           y
                                Don't Answer?    n           y Number of Rings: 3
                                All?            n           y
                                DND/SAC/Goto Cover? n           n

                                COVERAGE POINTS
                                Terminate to Coverage Pts. with Bridged Appearance? n

                                Point1: 1205 Point2: 1215 Point3: 2200
                                Point4: ____ Point5: ____ Point6: ____
    
```

Form obtained using  
 "display\_coverage\_path1"  
 command. Shows link from  
 call coverage path 2 to 3.

```

                                COVERAGE PATH                                Page 1 of 1
                                Coverage Path Number: 2
                                Next Path Number: 3 Linkage

                                COVERAGE CRITERIA
                                Station/Group Status Inside Call Outside Call
                                Active?           n           n
                                Busy?             y           n
                                Don't Answer?    y           n Number of Rings: 3
                                All?            n           n
                                DND/SAC/Goto Cover? n           n

                                COVERAGE POINTS
                                Terminate to Coverage Pts. with Bridged Appearance? n

                                Point1: 1215 Point2: 2200 Point3: 2000
                                Point4: ____ Point5: ____ Point6: ____
    
```

Extension  
 number  
 1205 = Another manager  
 1215 = Assistant manager  
 2000 = AUDIX  
 2200 = Coverage answer  
 group with ici

```

                                COVERAGE PATH                                Page 1 of 1
                                Coverage Path Number: 3
                                Next Path Number: Linkage

                                COVERAGE CRITERIA
                                Station/Group Status Inside Call Outside Call
                                Active?           n           n
                                Busy?             n           n
                                Don't Answer?    n           n Number of Rings: 3
                                All?            y           n
                                DND/SAC/Goto Cover? n           n

                                COVERAGE POINTS
                                Terminate to Coverage Pts. with Bridged Appearance? n

                                Point1: 2200 Point2: 2000 Point3: ____
                                Point4: ____ Point5: ____ Point6: ____
    
```

sc-cvpth LJK 062496

Figure 4-2. Coverage Path form examples

## Interactions

---

### ■ Administration without Hardware

Stations administered without hardware translation interact with Call Coverage as if all their call appearances are busy. A disassociated station can have Call Coverage active for the following call-coverage groups:

- Coverage answer groups
- Hunt groups
- Intercom groups
- Pickup groups
- Terminating Extension Groups (TEGs)
- Vector Directory Number (VDN)

### ■ Agent Call Handling

Do not assign Cover All Calls to agents with the Automatic Answer option. Any call (ACD or non-ACD), to an extension that has Automatic Answer enabled and has its coverage redirection criteria administered as Cover All Calls does not go to coverage but to the called extension. Cover All Calls redirection criteria have no effect on an incoming call when a user is in the Auto-Answer mode.

### ■ Automatic Callback and Ringback Queuing

Callback calls do not redirect to coverage. The caller can activate Automatic Callback when ringing, redirection notification signal, or busy signal is heard.

### ■ Automatic Intercom, Dial Intercom, and Priority Calling

Calls using these features are not redirected to coverage unless the caller presses the Go to Cover button.

### ■ Bridged Call Appearance

Coverage criteria for bridged call appearances are based entirely on the criteria of the primary extension associated with the bridged call appearance.

If a voice-terminal user has activated Send All Calls on the primary extension, incoming calls still ring bridged call appearances of that extension as long as a temporary bridged appearance of the call is maintained at the primary extension.

The switch blocks a user from bridging onto a call that has routed off-net while the call is undergoing call classification.

- Call Detail Recording

When Coverage of Calls Redirected Off-Net is enabled, a CDR record is generated only after the call has actually been answered off-net. The dialed number in the record is the off-net number to which the call covers. The calling number is the station that is covered to the off-net location.

- Call Forwarding

Call Forwarding provides a temporary override of the redirection criteria. Normally, calls forward instead of redirecting to coverage. When a forwarding extension's redirection criteria are met at the designated (forwarded-to) extension, the call redirects to the forwarding extension's coverage path.

The system allows calls forwarded off-net to be tracked for busy or no-answer conditions and to return for further call-coverage processing under those conditions. However, if the principal does not have a coverage path, the system does not track the call and it is left at the off-net destination regardless of whether it is answered or busy.

If the principal has Send All Calls activated, the system does not attempt Call Forwarding Off-Net, except for priority calls. Likewise, the system does not attempt Call Forwarding Off-Net for coverage paths that specify Cover All, except for priority calls.

If Cover All Calls is part of the coverage redirection criteria and if Call Forwarding is active at a voice terminal, incoming priority calls forward to the designated extension.

The Redirection Notification Signal applies to both Call Coverage and Call Forwarding.

If an extension has both Send All Calls and Call Forwarding activated, calls to that extension that immediately can be redirected to coverage are redirected. However, other calls, such as Priority Calls, are forwarded to the designated extension.

Activation of Send All Calls at the forwarded-to extension does not affect calls forwarded to that extension.

- Call Pickup

Any call redirected to a covering user who is a member of a Call Pickup group can be answered by other members of the group.

- Centralized Attendant Service

If an incoming CAS call is directed to a hunt group, the call is not redirected to the hunt group's coverage path.

- Class of Restriction and Controlled Restrictions

Users who may normally be restricted from receiving calls can still receive calls directed to them via Call Coverage.

- Conference

The switch blocks users from conferencing another party onto a call which has routed off-net while that call is undergoing call classification. If any party on the call is on hold, the call routes off-net, but without undergoing call classification, even when the `Coverage of Calls Redirected Off-Net` is enabled.

- Direct Department Calling, Uniform Call Distribution, and Automatic Call Distribution

If a user has an `Auxiliary Work` button, and activates or deactivates `Send All Calls`, the `Auxiliary Work` function associated with DDC or UCD is activated or deactivated simultaneously.

If a user has no `Auxiliary Work` button, activating or deactivating `Send All Calls` still makes the user available or unavailable for DDC and UCD calls, but `Auxiliary Work` is not activated or deactivated. The `Auxiliary Work activate or deactivate code` and the DDC, UCD, and ACD extension must be dialed to activate the `Auxiliary Work` function.

Activating or deactivating the `Auxiliary Work` function does not activate or deactivate `Send All Calls`.

- Hold

If a covering user puts a call on hold, and the principal picks up on the call, the coverage appearance may or may not be dropped, depending on administration.

If any party is on hold when a coverage call routes off-net, that call does not undergo call classification, even when `Coverage of Calls Redirected Off-Net` is enabled.

- Internal Automatic Answer

If an internal call is redirected to another voice terminal by a `Call Coverage` redirection criteria, then that call is eligible for IAA at that voice terminal.

IAA does not apply to calls to the original called extension when:

- The called voice terminal has activated `Do Not Disturb`, `Send All Calls`, or `Cover All Calls`
- The calling voice terminal has selected `Go To Cover` before placing the call

Calls directed to a `Coverage Answering Group` are not eligible for IAA.

- Leave Word Calling

`Call Coverage` can be used with or without LWC. However, the two features complement each other. When a covering user activates LWC during a coverage call, a message is left for the principal to call the covering user. When a covering user activates `Coverage Callback` during a coverage call, a message is left for the principal to call the internal caller.

- Night Service

Calls routed to the night station via Night Service follow the coverage path of the night extension under all coverage criteria except Send All Calls.

- Privacy — Manual Exclusion

When the primary or principal user bridges onto a call that went to coverage and has been answered at the coverage point, the user is not dropped when Privacy — Manual Exclusion is activated.

- Temporary Bridged Appearance

Calls redirected to coverage maintain an appearance on the called voice terminal if a call appearance is available to handle the call. The called party can bridge onto the call at any time. The system can be administered to allow a temporary bridged appearance of the call to either remain at or be removed from the covering voice terminal after the principal bridges onto the call.

A Temporary Bridged Appearance is maintained for calls covered by an off-net coverage point if the Coverage of Calls Redirected Off-Net feature is enabled. A Temporary Bridged Appearance cannot be maintained for calls if the coverage point is linked to AUDIX.

Consult calls use the temporary bridged appearance maintained on the call. At the conclusion of a consult call, the bridged appearance is no longer maintained. If the principal chooses not to talk with the calling party, the principal cannot bridge onto the call later.

If a call that has, or has had, a temporary bridged appearance is conferenced or transferred, and redirects to coverage again, a temporary bridged appearance is not maintained at the conferenced-to or transferred-to extension.

- Tenant Partitioning

The caller and called party must be able to access a coverage point. The caller is considered to be the covering user and the called party is considered to be the covered user. Both parties must be able to access the coverage point.

- Transfer

The switch blocks a user from transferring a call which has routed off-net to another party while that call is undergoing call classification. If any party on a call that has routed off-net is on hold, the call does route off-net without undergoing call classification, even when Coverage of Calls Redirected Off-Net is enabled.

Transfer interacts with Call Coverage as listed in the following table.

| <b>Source</b> | <b>Transfer initiator</b> | <b>Destination</b> | <b>Coverage type</b> |
|---------------|---------------------------|--------------------|----------------------|
| External      | Local station             | Local station      | External             |
|               | Local station             | Remote station     | External             |
|               | Remote station            | Local station      | Internal             |
|               | Remote station            | Remote station     | Internal             |
|               | Attendant                 | Local station      | External             |
|               | Attendant                 | Remote station     | External             |
| Internal      | Local station             | Local station      | Internal             |
|               | Local station             | Remote station     | Internal             |
|               | Remote station            | Local station      | Internal             |
|               | Remote station            | Remote station     | Internal             |
|               | Attendant                 | Local station      | External             |
|               | Attendant                 | Remote station     | External             |



**NOTE:**

The coverage criteria for transferred DID calls depends upon the `External Treatment For Transferred Incoming Calls` field on the Feature-Related System Parameters form.

## Call Detail Recording

---

Call Detail Recording (CDR) collects detailed information about all incoming and outgoing calls on specified trunk groups and, if you use intraswitch CDR, about calls between designated extensions on the switch. It sends this information to a printer or other CDR output device that may also provide reports.

You can use this information to compute call costs, allocate charges, analyze calling patterns, detect unauthorized calls, and keep track of unnecessary calls. For additional information on CDR, see Call Detail Acquisition and Processing Reference.

Call Detail Recording has the following capabilities:

- Account Code Dialing and Forced Entry of Account Codes (FEAC)
- Call Splitting for Incoming and Outgoing Trunks
- Intraswitch CDR
- Privacy

### How to administer CDR

---

#### Required forms

| Form                                       | Field                          | Page                  |
|--|--------------------------------|-----------------------|
| Trunk Groups                               | ■ CDR Reports                  | <a href="#">7-115</a> |
|  | ■ Answer Supervision Timeout   |                       |
|  | ■ Disconnect Supervision       |                       |
| CDR System Parameters                      | ■ All                          | <a href="#">5-63</a>  |
| Inter-exchange Carrier Codes               | ■ All                          | <a href="#">5-177</a> |
| Feature Access Code (FAC)                  | ■ CDR Account Code Access Code | <a href="#">5-113</a> |
| Netcon Data Module                         | ■ All                          | <a href="#">6-245</a> |
| System Port Data Module                    | ■ All                          | <a href="#">6-248</a> |
| Loudspeaker Paging and Code Calling Access | ■ CDR                          | <a href="#">5-209</a> |

- Assign a netcon channel using the Data Module form and enter data-channel or netcon channel for the type.
- Assign a system port using the Data Module form and enter system port for the type.

- A Data Line circuit pack can also be used in conjunction with an ADU to connect to an output device. If the CDR output device is connected to a Data Line circuit pack via an ADU, administer a Data Line Type Data Module.

For more information about how to connect a CDR output device, see *DEFINITY Enterprise Communications Server Release 6 Installation for Adjuncts and Peripherals*.

## How to administer Account Code Dialing

### Required forms

| Form                      | Field  | Page                  |
|---------------------------|--|-----------------------|
| Feature Access Code (FAC) | ■ CDR Account Code Access Code                       | <a href="#">5-113</a> |
| CDR System Parameters     | ■ CDR Account Code Length                            | <a href="#">5-63</a>  |
| Station                   | ■ Feature button assignments<br>— account (optional) | <a href="#">6-14</a>  |

## How to administer FEAC

Forced Entry of Account Codes is a subset of account code dialing. You must administer account code dialing in addition to the fields described below.

### Required forms

| Form                               | Field  | Page                  |
|------------------------------------|--|-----------------------|
| System Parameters Customer-Options | ■ Forced Entry of Account Codes  | <a href="#">5-277</a> |
| CDR System Parameters              | ■ Force Entry of Account Codes for Calls Marked on Toll Analysis Form<br>■ CDR Account Code Length | <a href="#">5-63</a>  |
| Class of Restriction               | ■ Forced Entry of Account Codes  | <a href="#">5-72</a>  |

*Continued on next page*



**Required forms — Continued**

| Form  | Field  | Page                  |
|---|--|-----------------------|
| Call Originating Facility (station, data module, trunk group) | ■ COR  | N/A                   |
| Toll Analysis   | ■ Dialed String<br>■ Min<br>■ Max<br>■ CDR FEAC      | <a href="#">5-299</a> |
| Station   | ■ Feature button assignments<br>— account (optional) | <a href="#">6-14</a>  |

**How to administer Incoming Trunk Call Splitting**

**Required forms**

| Form                  | Field  | Page                 |
|-----------------------|--|----------------------|
| CDR System Parameters | ■ Record Outgoing Calls Only = n<br>■ Inc Trk Call Splitting<br>■ Inc Attd Call Record | <a href="#">5-63</a> |

**How to administer Outgoing Trunk Call Splitting**

**Required forms**

| Form                  | Field  | Page                 |
|-----------------------|--|----------------------|
| CDR System Parameters | ■ Outg Trk Call Splitting<br>■ Outg Attd Call Record | <a href="#">5-63</a> |

## How to administer Intraswitch CDR

### Required forms

| Form                  | Field             | Page                  |
|-----------------------|-------------------|-----------------------|
| CDR System Parameters | ■ Intraswitch CDR | <a href="#">5-63</a>  |
| Intra-Switch CDR Form | ■ All             | <a href="#">5-183</a> |

## How to administer CDR Privacy

### Required forms

| Form                  | Field                      | Page                 |
|-----------------------|----------------------------|----------------------|
| Station (All)         | ■ CDR Privacy              | <a href="#">6-28</a> |
| CDR System Parameters | ■ Privacy — Digits to Hide | <a href="#">5-63</a> |

## Detailed description

CDR tracks call information on a per-trunk-group or station-to-station basis. For every trunk group (including auxiliary trunks) that you administer for CDR reports, the system keeps track of incoming, outgoing and tandem calls. You can also receive reports on temporary signaling connections (TSCs) that involve trunks, and calls made using loudspeaker paging or code calling access.

You can also ask the system to report on ineffective call attempts. This may greatly increase the number of calls recorded, but may also help you to increase security, since the system records call attempts that are blocked because of insufficient calling privileges. This can also let you know if your users are not able to make calls because all trunks are busy.

Some call accounting systems do not support all of the information offered by CDR. See your Lucent Technologies representative for details.

## Account Code Dialing

Account Code Dialing allows certain calls to be associated with a particular project or account number. To do this, users enter account codes when they place certain types of outgoing calls. These account codes then appear on the call record, which you can use for accounting or billing purposes. Account code dialing can be optional or mandatory (forced).

To associate an account code with a particular call, a user first dials the CDR account code access code that you have established, then dials the desired account code. Next, the user dials the desired trunk access code, or ARS access code, followed by the phone number.

The call record contains the account code, TAC or ARS access code, and the phone number. It does not contain the account code FAC.

## Forced Entry of Account Codes

You can force your users to enter account codes on a system-wide, per-trunk or per-user basis, or on the basis of the digit string the user dials. If you have this feature in place, the system rejects any call that requires an account code where one is not supplied. To maximize system security, it is recommended that you use Forced Entry of Account Codes (FEAC).

### SECURITY ALERT:

*DEFINITY ECS does not verify account codes. As long as the user enters a digit string of the appropriate length, the system allows the call. You must use Authorization Codes if you want the system to determine if the user is authorized to make the call.*

You can assign FEAC in the following ways:

- All calls marked for FEAC on the Toll Analysis table  
If you activate this CDR system parameter, all users must dial an account code when the digits dialed match a digit string with FEAC=y. This includes calls made by ARS or TAC.
- Toll calls made by users with a specific class of restriction (COR)  
If FEAC is assigned to a specific COR, any voice-terminal user assigned that COR must dial an account code before making calls that are administered forced entry of account codes.
- All calls made over a trunk group with FEAC in COR (TAC calls)  
Users cannot access a trunk group that is assigned a COR with FEAC until they dial an account code. If a call is routed via ARS, the system does not check for FEAC in the trunk group's COR. Therefore, if you want your users to enter account codes for ARS calls, you must administer this in the Toll Analysis table.

If an account code is required for a call and the user does not enter one, the system responds with intercept tone.

The following types of calls never require an account code:

- Attendant originated call
- Busy verification of a trunk by an attendant or voice-terminal user
- DCS (unless required by the trunk group's COR)
- Personal CO Line
- Remote access without barrier codes
- Trunk-to-trunk connections

## Call Splitting

Call splitting keeps track of calls where more than two parties are involved. These can be calls that are transferred, conferenced, or where an attendant becomes involved. If you have call splitting activated and any of these situations arise, CDR produces a separate record for each new party on the call.

You can administer call splitting for both incoming and outgoing trunks, and both can have attendant calls recorded separately.

### Incoming trunk call splitting

If incoming trunk call splitting is enabled, CDR starts a new record whenever an incoming trunk call is conferenced or transferred. Whenever a user drops from the call or the call is successfully transferred, CDR outputs the record relevant to this user's participation. These call records show the amount of time each party was on the call, the incoming trunk access code, the dialed number and the condition code, as well as the other fields specified in the record format.

For incoming trunk calls that are conferenced, CDR creates a new record whenever a new party comes on the call. The duration field in these records shows how long each party participated on the call. Conference calls produce records with duration fields that overlap. The duration of a transferred call begins when the transferring party presses the TRANSFER button for the second time, so there is no overlap.

If ITCS is enabled and an incoming trunk call is conferenced or transferred to a local extension that is optioned for Intraswitch CDR, the call produces an incoming trunk call record. It does not produce an Intraswitch record.

### ITCS examples

The following scenarios depict calls made with ITSC active. The tables that follow do not show all fields, only those that may change due to call splitting. Call durations are approximate.

Caller A (TAC 123) makes an incoming trunk call to switch party B (5657890). They talk for 2 minutes. B then conferences in C (ext. 54321), and D (ext. 59876). The entire group talks for another 8 minutes, at which point B drops off the call. This produces a record for segment A–B.

A, C and D continue to talk for another 5 minutes. All remaining parties drop, producing two more records; A–C and A–C. Note that each record shows the incoming trunk ID as the calling number.

**Table 4-39. ITCS conference**

| Segment | Duration | Condition Code | Access Code Used | Calling Number | Dialed Number |
|---------|----------|----------------|------------------|----------------|---------------|
| A–B     | 0:10:0   | C              |                  | 123            | 5657890       |
| A–C     | 0:13:0   | C              |                  | 123            | 54321         |
| A–D     | 0:13:0   | C              |                  | 123            | 59876         |

A (TAC 123) calls Station B (57890). They talk for 1 minute, then B transfers the call to C (54321). CDR generates a record for segment A–B. A and C talk for 5 minutes. CDR generates a record for segment A–C.

**Table 4-40. ITCS transfer**

| Segment | Duration | Condition Code | Access Code Used | Calling Number | Dialed Number |
|---------|----------|----------------|------------------|----------------|---------------|
| A–B     | 0:01:0   | 9              |                  | 123            | 5657890       |
| A–C     | 0:05:0   | 9              |                  | 123            | 54321         |

A (TAC 123) calls switch party B (5657890), they talk for one minute. B transfers the call to public-network party C (5665555), they talk for 4 minutes. Note that the duration of the original incoming trunk call includes the time after the call was transferred to an outgoing trunk, until all trunk parties drop.

**Table 4-41. ITCS transfer to outgoing trunk**

| Segment | Duration | Condition Code | Access Code Used | Calling Number | Dialed Number |
|---------|----------|----------------|------------------|----------------|---------------|
| A–B     | 0:05:0   | 9              |                  | 123            | 5657890       |
| A–C     | 0:04:0   | 9              | 345              | 123            | 5665555       |

### Outgoing trunk call splitting

If outgoing trunk call splitting is active, CDR creates records of transferred calls as described above for incoming trunk call splitting. For conferenced calls, the originator of the conference will be charged until he or she drops from the call, at which point CDR begins a second record for the conferenced user. Records for parties on a conference do not overlap; they are split.

### OTCS examples

In the next example, switch party A (57890) calls B(7771234), talks for 5 minutes, then conferences in C (7775678). They all talk for another 5 minutes, at which point all parties drop.

Table 4-42. OTCS conference

| Segment | Duration | Condition Code | Access Code Used | Calling Number | Dialed Number |
|---------|----------|----------------|------------------|----------------|---------------|
| A-B     | 0:10:0   | C              | 345              | 57890          | 7771234       |
| A-C     | 0:05:0   | C              | 345              | 57890          | 7775678       |

Switch party A (51234) calls public-network party B (5659999). They talk for 5 minutes. A then transfers the call to switch party C (54444).

Table 4-43. OTCS transfer

| Segment | Duration | Condition Code | Access Code Used | Calling Number | Dialed Number |
|---------|----------|----------------|------------------|----------------|---------------|
| A-B     | 0:01:0   | A              | 345              | 51234          | 5659999       |
| C-B     | 0:05:0   | A              | 345              | 54444          | 5659999       |

### Attendant call recording

Both incoming and outgoing call splitting give you the option of recording the attendant portion of calls that are transferred. To enable this option, set Incoming and/or Outgoing Attendant Call Record to **y**.

If either incoming or outgoing trunk call splitting is enabled, the attendant portion of a conference call always produces a separate record.

### Attendant call recording examples

Public-network party A (TAC 123) calls the attendant (Attd), and asks to be transferred to switch party B (58888).

**Table 4-44. Attendant transfer incoming trunk**

| Segment | Duration | Condition Code | Access Code Used | Calling Number | Dialed Number |
|---------|----------|----------------|------------------|----------------|---------------|
| A-Attd  | 0:01:0   | 9              |                  | 123            | Attd          |
| A-B     | 0:05:0   | 9              |                  | 123            | 58888         |

The attendant (Attd) dials switch party A (59999), then transfers the call to public-network party B (4445678).

**Table 4-45. Attendant transfer outgoing trunk**

| Segment | Duration | Condition Code | Access Code Used | Calling Number | Dialed Number |
|---------|----------|----------------|------------------|----------------|---------------|
| Attd-B  | 0:01:0   | A              | 345              | Attd           | 4445678       |
| A-B     | 0:05:0   | A              | 345              | 59999          | 4445678       |

### Intraswitch CDR

Intraswitch CDR generates call records for calls to and from users on the local switch. For the system to generate an intraswitch CDR record, one of the extensions involved in a call must have intraswitch CDR assigned.

If a station is optioned for Intraswitch CDR, and ITCS is also enabled, ITCS overrides Intraswitch CDR. That is, incoming trunk calls involving the station produce trunk call records, not Intraswitch CDR records.

The output for intraswitch CDR follows the same format you have established for other call records. Certain fields do not appear on intraswitch call records, because they do not pertain to internal calls. For example, an intraswitch record does not contain trunk access codes or circuit IDs, since these do not apply.

Some calls may seem to be intraswitch CDR calls, but actually result in trunk calls. For example, a station-to-station call to an extension that is forwarded to an outgoing trunk produces only a trunk CDR record, regardless of whether or not either station has intraswitch CDR assigned.

You can assign intraswitch CDR to terminating extension groups (TEGs), stations, data modules, VDNs, PRI endpoints, access endpoints, or hunt groups. The number that appears in the dialed number field depends on whether you have administered CDR System Parameters to record hunt group/member or

VDN information. You *cannot* assign intraswitch CDR to attendant consoles or CallVisor ASAI stations.

 **NOTE:**

If an extension with intraswitch CDR is neither the originator of the call nor the dialed number of the call, the system does not produce a call record, even though the extension might be a party on the call (via Call Pickup, Call Forwarding, etc.).

## Privacy

CDR Privacy allows you to administer the system to blank a given number of dialed digits from a CDR report. This is useful when it is necessary to know details of a person's calls for accounting purposes, but it is not necessary or desirable to know the exact number called.

You can administer the number of digits to hide, up to 7. The value in Privacy Digits to Hide determines how many digits do not appear on the call record. This parameter is system-wide. Whether or not an individual's calls receive Privacy treatment is determined by the CDR `Privacy` field on the Station form.

When an adjunct-originated call is made on behalf of a hunt group and the CDR system parameter `Calls to Hunt Group - Record` option is set to **group-ext**, then CDR privacy does not apply. If this field is set to **member-ext**, privacy does apply.

 **NOTE:**

Certain countries have requirements that a certain number of digits must be blanked from every call. Also, certain report processors do not support this option.

## CDR output

If your system uses two CDR output formats, one is administered as the primary CDR output format; the other is administered as the secondary CDR output format. The secondary output format is typically used for a local storage format (CDRU) to provide CDR data to NCOSS for assessing network performance or helping to find network problems.

The primary and secondary ports work independently. Each port will work even if the link to the other port is down. If a link is down for more than a minute, some data may be lost. However, the most recent 500 (Release 5vs/si/csi and later), or 1,900 (Release 5r and later) records are stored for the primary port even when a loss of records occurs. When the link comes back up, these records are output on a first-in, first-out basis.



If the CDR buffer is full, you can select a call record handling option to determine which of the following occurs:

- Calls are blocked with a reorder tone
- Calls overwrite records
- Calls are routed to an attendant as non-CDR calls

Overwrite old CDR records with new ones if the buffer is full.

The following information applies to the port used for the secondary CDR output device:

- Data going to the secondary port should be the same as that going to the primary port. You can use the following record types for secondary output: LSU, Int-Direct, Int-Process, and Unformatted.
- If the system experiences problems in sending records to the primary CDR Output Device, the system discontinues sending records to the secondary port for 2 minutes. The secondary port should be run at the highest possible speed in order to prevent loss of information.
- If the output buffer is full, the system busies out the secondary port for 2 minutes. This makes system resources available to send data to the primary CDR port before the data is lost. The system continues to busy out the secondary port for 2-minute intervals until less than 400 records (1800 for Release 5r and later) remain in the buffer.

## CDR Record formats

---

Two types of formats are sent to the CDR output device, date record and call detail formats.

### Date record format

CDR sends date information to the CDR device once a day (at midnight), or when the device is connected. This is a non-call record, and contains only the information shown in the date record formats below.

Several formats are available for date records: one for CDRUs, one for the printer, and one for the TELESEER. The records sent to the TELESEER and printer contain the date only while the records sent to the CDRU contain time. See [Table 4-46](#), [Table 4-47](#), and [Table 4-48](#).

### NOTE:

The date can be in month/day *or* day/month format, as selected on the CDR System Parameters form. The date/time may also be reversed for international standards.

**Table 4-46. Date Record Format to LSU, LSU-Expand, Unformatted, and Customized**

| <b>Position</b> | <b>Data Field Description</b>        |
|-----------------|--------------------------------------|
| 1-2             | Hour (leading 0 added if needed)     |
| 3               | Colon (:)                            |
| 4-5             | Minute (leading 0 added if needed)   |
| 6               | Blank                                |
| 7-8             | Month (Leading Zero Added if Needed) |
| 9               | Slash (/)                            |
| 10-11           | Day (leading 0 added if needed)      |
| 12              | Carriage return                      |
| 13              | Line feed                            |
| 14-16           | Null                                 |

**Table 4-47. Date Record Format for Printer and Expanded**

| <b>Position</b> | <b>Data Field Description</b>     |
|-----------------|-----------------------------------|
| 1-2             | Month (leading 0 added if needed) |
| 3               | Space                             |
| 4-5             | Day (leading 0 added if needed)   |
| 6               | Carriage return                   |
| 7               | Line feed                         |
| 8-10            | Null                              |

**Table 4-48. Date Record Format for TELESEER 59 Character, Int-Proc, Int-Direct, and Int-ISDN**

| <b>Position</b> | <b>Data Field Description</b>     |
|-----------------|-----------------------------------|
| 1-2             | Month (leading 0 added if needed) |
| 3-4             | Day                               |
| 5               | Carriage return                   |
| 6               | Line feed                         |
| 7-9             | Null                              |

## **Call Detail Record Formats**

### **Customized Format**

You can use the customized record format to make up your own call record. You can determine the data elements you want and their positions in the record. This method may be necessary if you want to include certain data elements that are not available on the standard formats.

However, whatever device you use to interpret the CDR data needs to be programmed to accept these formats. Consult your Lucent Technologies representative before using a custom record format.

**Table 4-49. CDR Data Format — TELESEER**

| <b>Position</b> | <b>Data Field Description</b> |
|-----------------|-------------------------------|
| 1-3             | Space                         |
| 4-5             | Time of day-hours             |
| 6-7             | Time of day-minutes           |
| 8               | Duration-hours                |
| 9-10            | Duration-minutes              |
| 11              | Duration-tenths of minutes    |
| 12              | Condition code                |
| 13-15           | Access code dialed            |
| 16-18           | Access code used              |
| 19-33           | Dialed number                 |
| 34-38           | Calling number                |
| 39-53           | Account code                  |
| 54              | FRL                           |
| 55              | IXC                           |
| 56-58           | Incoming circuit ID           |
| 59-61           | Outgoing circuit ID           |
| 62              | Feature flag                  |
| 63-69           | Authorization code            |
| 70-76           | Space                         |
| 77              | Carriage return               |
| 78              | Line feed                     |
| 79-81           | Null                          |

**Table 4-50. CDR Data Format — ISDN TELESEER**

| <b>Position</b> | <b>Data Field Description</b> |
|-----------------|-------------------------------|
| 1-3             | Space                         |
| 4-5             | Time of day-hours             |
| 6-7             | Time of day-minutes           |
| 8               | Duration-hours                |
| 9-10            | Duration-minutes              |
| 11              | Duration-tenths of minutes    |
| 12              | Condition code                |
| 13-15           | IXC                           |
| 16-18           | Access code used              |
| 19-33           | Dialed number                 |
| 34-38           | Calling number                |
| 39-53           | Account code                  |
| 54              | INS (units)                   |
| 55              | FRL                           |
| 56-58           | Incoming circuit ID           |
| 59-61           | Outgoing circuit ID           |
| 62              | Feature flag                  |
| 63-69           | Authorization code            |
| 70-71           | INS (hundreds, tens)          |
| 72-76           | Space                         |
| 77              | Line feed                     |
| 78-80           | Null                          |

**Table 4-51. CDR Data Format — Enhanced TELESEER**

| <b>Position</b> | <b>Data Field Description</b> |
|-----------------|-------------------------------|
| 1-3             | Space                         |
| 4-5             | Time of day-hours             |
| 6-7             | Time of day-minutes           |
| 8               | Duration-hours                |
| 9-10            | Duration-minutes              |
| 11              | Duration-tenths of minutes    |
| 12              | Condition code                |
| 13-16           | IXC code                      |
| 17-19           | Access code used              |
| 20-34           | Dialed number                 |
| 35-39           | Calling number                |
| 40-54           | Account code                  |
| 55              | ISDN NSV (units)              |
| 56              | FRL                           |
| 57-59           | Incoming circuit ID           |
| 60-62           | Outgoing circuit ID           |
| 63              | Feature flag                  |
| 64-70           | Authorization code            |
| 71-72           | ISDN NSV (hundreds, tens)     |
| 73-76           | Space                         |
| 77              | Carriage return               |
| 78              | Line feed                     |
| 79-81           | Null                          |

**Table 4-52. CDR Data Format — 59 Character**

| <b>Position</b> | <b>Data Field Description</b> |
|-----------------|-------------------------------|
| 1-2             | Time of day-hours             |
| 3-4             | Time of day-minutes           |
| 5               | Duration-hours                |
| 6-7             | Duration-minutes              |
| 8               | Duration-tenths of minutes    |
| 9               | Condition code                |
| 10-12           | Access code dialed            |
| 13-15           | Access code used              |
| 16-30           | Dialed number                 |
| 31-35           | Calling number                |
| 36-50           | Account code                  |
| 51              | FRL                           |
| 52              | IXC                           |
| 53-55           | Incoming circuit ID           |
| 56-58           | Outgoing circuit ID           |
| 59              | Carriage return               |
| 60              | Line feed                     |
| 61-63           | Null                          |

**Table 4-53. CDR Data Format — Printer**

| <b>Position</b> | <b>Data Field Description</b> |
|-----------------|-------------------------------|
| 1-2             | Time of day-hours             |
| 3-4             | Time of day-minutes           |
| 5               | Space                         |
| 6               | Duration-hours                |
| 7-8             | Duration-minutes              |
| 9               | Duration-tenths of minutes    |
| 10              | Space                         |
| 11              | Condition code                |
| 12              | Space                         |
| 13-15           | Access code dialed            |
| 16              | Space                         |
| 17-19           | Access code used              |
| 20              | Space                         |
| 21-35           | Dialed number                 |
| 36              | Space                         |
| 37-41           | Calling number                |
| 42              | Space                         |
| 43-57           | Account code                  |
| 58              | Space                         |
| 59-65           | Authorization code            |
| 66-69           | Space                         |
| 70              | FRL                           |
| 71              | Space                         |
| 72              | IXC                           |
| 73              | Space                         |
| 74-76           | Incoming circuit ID           |
| 77              | Space                         |
| 78-80           | Outgoing circuit ID           |
| 81              | Space                         |
| 82              | Feature flag                  |
| 83              | Carriage return               |
| 84              | Line feed                     |



**Table 4-54. CDR Data Format — ISDN Printer**

| <b>Position</b> | <b>Data Field Description</b> |
|-----------------|-------------------------------|
| 1-2             | Time of day-hours             |
| 3-4             | Time of day-minutes           |
| 5               | Space                         |
| 6               | Duration-hours                |
| 7-8             | Duration-minutes              |
| 9               | Duration-tenths of minutes    |
| 10              | Space                         |
| 11              | Condition code                |
| 12              | Space                         |
| 13-15           | IXC                           |
| 16              | Space                         |
| 17-19           | Access code used              |
| 20              | Space                         |
| 21-35           | Dialed number                 |
| 36              | Space                         |
| 37-41           | Calling number                |
| 42              | Space                         |
| 43-57           | Account code                  |
| 58              | Space                         |
| 59-65           | Authorization code            |
| 66              | Space                         |
| 67-68           | INS (hundreds, tens)          |
| 69              | Space                         |
| 70              | INS (units)                   |
| 71              | Space                         |
| 72              | FRL                           |
| 73              | Space                         |
| 74-76           | Incoming circuit ID           |
| 77              | Space                         |
| 78-80           | Outgoing circuit ID           |
| 81              | Space                         |
| 82              | Feature flag                  |
| 83              | Carriage return               |
| 84              | Line feed                     |

**Table 4-55. CDR Data Format — Enhanced Printer**

| <b>Position</b> | <b>Data Field Description</b> |
|-----------------|-------------------------------|
| 1-2             | Time of day-hours             |
| 3-4             | Time of day-minutes           |
| 5               | Space                         |
| 6               | Duration-hours                |
| 7-8             | Duration-minutes              |
| 9               | Duration-tenths of minutes    |
| 10              | Space                         |
| 11              | Condition code                |
| 12              | Space                         |
| 13-16           | IXC code                      |
| 17              | Space                         |
| 18-21           | Access code used              |
| 22              | Space                         |
| 23-37           | Dialed number                 |
| 38              | Space                         |
| 39-43           | Calling number                |
| 44              | Space                         |
| 45-59           | Account code                  |
| 60              | Space                         |
| 61-67           | Authorization code            |
| 68              | Space                         |
| 69-71           | ISDN NSV                      |
| 72              | Space                         |
| 73              | FRL                           |
| 74              | Space                         |
| 75-77           | Incoming circuit ID           |
| 78              | Space                         |
| 79-81           | Outgoing circuit ID           |
| 82              | Space                         |
| 83              | Feature flag                  |
| 84              | Carriage return               |
| 85              | Line feed                     |

**Table 4-56. CDR Data Format — LSU-Expand**

| Position | Data Field Description            |
|----------|-----------------------------------|
| 1-2      | Time of day-hours                 |
| 3-4      | Time of day-minutes               |
| 5        | Space                             |
| 6        | Duration-hours                    |
| 7-8      | Duration-minutes                  |
| 9        | Duration-tenths of minutes        |
| 10       | Space                             |
| 11       | Condition code                    |
| 12       | Space                             |
| 13-15    | Access code dialed                |
| 16-18    | Access code used                  |
| 19       | Space                             |
| 20-34    | Dialed number                     |
| 35       | Space                             |
| 36-39    | Calling number                    |
| 40       | Space                             |
| 41-45    | Account code                      |
| 46       | Space                             |
| 47-53    | Authorization code                |
| 54-57    | Space                             |
| 58       | FRL                               |
| 59       | Space                             |
| 60       | Calling number (1st digit)        |
| 61       | Space                             |
| 62-63    | Incoming circuit ID (tens, units) |
| 64       | Space                             |
| 65       | Feature flag                      |
| 66       | Space                             |
| 67-68    | Outgoing circuit ID (tens, units) |
| 69       | Space                             |
| 70       | Outgoing circuit ID (hundreds)    |
| 71       | Space                             |
| 72       | Incoming circuit ID (hundreds)    |
| 73       | IXC                               |
| 74       | Carriage return                   |
| 75       | Line feed                         |
| 76-78    | Null                              |

**Table 4-57. CDR Data Format — LSU**

| <b>Position</b> | <b>Data Field Description</b>                     |
|-----------------|---|
| 1               | Duration-hours                                    |
| 2-3             | Duration-minutes                                  |
| 4               | Duration-tenths of minutes                        |
| 5               | Condition code                                    |
| 6-8             | Access code dialed                                |
| 9-11            | Access code used                                  |
| 12-26           | Dialed number                                     |
| 27-30           | Calling number (digits 2-5 for 5-digit dial plan) |
| 31-35           | Account code (first 5 digits)                     |
| 36-42           | Authorization code or digits 6-12 of account code |
| 43-44           | Space or digits 13-14 of account code             |
| 45              | FRL or digit 15 of account code                   |
| 46              | Calling number (1st digit)                        |
| 47-48           | Incoming circuit ID (tens, units)                 |
| 49              | Feature flag                                      |
| 50-52           | Outgoing circuit ID (tens, units, hundreds)       |
| 53              | Incoming circuit ID (hundreds)                    |
| 54              | IXC   |
| 55              | Carriage return                                   |
| 56              | Line feed   |
| 57-59           | Null  |

**Table 4-58. CDR Data Format — ISDN LSU**

| Position | Data Field Description                               |
|----------|--|
| 1        | Duration-hours                                       |
| 2-3      | Duration-minutes                                     |
| 4        | Duration-tenths of minutes                           |
| 5        | Condition code                                       |
| 6-8      | IXC  |
| 9-11     | Access code used                                     |
| 12-26    | Dialed number  |
| 27-30    | Calling number (digits 2-5 for 5-digit dial plan)    |
| 31-35    | Account code (digits 1-5)                            |
| 36-42    | Authorization code or digits 6-12 of account code    |
| 43-44    | INS or digits 13-14 of account code                  |
| 45       | INS (3rd digit), FRL, or digit 15 of account code    |
| 46       | Calling number (1st digit of 5-digit calling number) |
| 47-48    | Incoming circuit ID (tens, units)                    |
| 49       | Feature flag   |
| 50-52    | Outgoing circuit ID (tens, units, hundreds)          |
| 53       | Incoming circuit ID (hundreds)                       |
| 54       | FRL  |
| 55       | Carriage return                                      |
| 56       | Line feed  |
| 57-59    | Null   |

**Table 4-59. CDR Data Format — Enhanced LSU**

| <b>Position</b> | <b>Data Field Description</b>                     |
|-----------------|---|
| 1               | Duration-hours                                    |
| 2-3             | Duration-minutes                                  |
| 4               | Duration-tenths of minutes                        |
| 5               | Condition code                                    |
| 6-9             | IXC code  |
| 10-12           | Access code used                                  |
| 13-27           | Dialed number                                     |
| 28-31           | Calling number                                    |
| 32-35           | Account code (digits 1-4)                         |
| 36-42           | Authorization code or digits 6-12 of account code |
| 43-45           | ISDN NSV  |
| 46              | 1st digit of a 5-digit calling number             |
| 47-48           | Incoming circuit ID (tens, units)                 |
| 49              | Feature flag                                      |
| 50-52           | Outgoing circuit ID (tens, units, hundreds)       |
| 53              | Incoming circuit ID (hundreds)                    |
| 54              | FRL   |
| 55              | Carriage return                                   |
| 56              | Line feed   |
| 57-59           | Null  |

**Table 4-60. CDR Data Format — Expanded**

| <b>Position</b> | <b>Data Field Description</b> |
|-----------------|-------------------------------|
| 1–2             | Time of day-hours             |
| 3–4             | Time of day-minutes           |
| 5               | Space                         |
| 6               | Duration-hours                |
| 7–8             | Duration-minutes              |
| 9               | Duration-tenths of minutes    |
| 10              | Space                         |
| 11              | Condition code                |
| 12              | Space                         |
| 13–16           | Access code dialed            |
| 17              | Space                         |
| 18–21           | Access code used              |
| 22              | Space                         |
| 23–37           | Dialed number                 |
| 38              | Space                         |
| 39–48           | Calling number                |
| 49              | Space                         |
| 50–64           | Account code                  |
| 65              | Space                         |
| 66–72           | Authorization code            |
| 73-76           | Space                         |
| 77              | FRL                           |
| 78              | Space                         |
| 79–81           | Incoming circuit ID           |
| 82              | Space                         |
| 83–85           | Outgoing circuit ID           |
| 86              | Space                         |
| 87              | Feature flag                  |
| 88              | Space                         |
| 89–90           | Attendant console             |
| 91              | Space                         |
| 92–95           | Incoming trunk access code    |

*Continued on next page*

**Table 4-60. CDR Data Format — Expanded — *Continued***

| Position | Data Field Description |
|----------|------------------------|
| 96       | Space                  |
| 97–98    | Node number            |
| 99       | Space                  |
| 100–102  | INS                    |
| 103      | Space                  |
| 104–106  | IXC                    |
| 107      | Space                  |
| 108      | BCC                    |
| 109      | Space                  |
| 110      | MA-UUI                 |
| 111      | Space                  |
| 112      | Resource flag          |
| 113      | Space                  |
| 114–117  | Packet count           |
| 118      | Space                  |
| 119      | TSC flag               |
| 120      | Space                  |
| 121–129  | Reserved               |
| 130      | Space                  |
| 131      | Carriage return        |
| 132      | Line feed              |
| 133–135  | Null                   |



**Table 4-61. CDR Data Format — Enhanced Expanded**

| <b>Position</b> | <b>Data Field Description</b> |
|-----------------|-------------------------------|
| 1-2             | Time of day-hours             |
| 3-4             | Time of day-minutes           |
| 5               | Space                         |
| 6               | Duration-hours                |
| 7-8             | Duration-minutes              |
| 9               | Duration-tenths of minutes    |
| 10              | Space                         |
| 11              | Condition code                |
| 12              | Space                         |
| 13-16           | Access code dialed            |
| 17              | Space                         |
| 18-21           | Access code used              |
| 22              | Space                         |
| 23-37           | Dialed number                 |
| 38              | Space                         |
| 39-48           | Calling number                |
| 49              | Space                         |
| 50-64           | Account code                  |
| 65              | Space                         |
| 66-72           | Authorization code            |
| 73              | Space                         |
| 74-75           | Time in queue                 |
| 76              | Space                         |
| 77              | FRL                           |
| 78              | Space                         |
| 79-81           | Incoming circuit ID           |
| 82              | Space                         |
| 83-85           | Outgoing circuit ID           |
| 86              | Space                         |
| 87              | Feature flag                  |
| 88              | Space                         |
| 89-90           | Attendant console             |

*Continued on next page*

**Table 4-61. CDR Data Format — Enhanced Expanded — *Continued***

| <b>Position</b> | <b>Data Field Description</b>         |
|-----------------|---------------------------------------|
| 91              | Space                                 |
| 92–95           | Incoming TAC                          |
| 96              | Space                                 |
| 97–98           | Node number                           |
| 99              | Space                                 |
| 100–102         | ISDN NSV                              |
| 103             | Space                                 |
| 104–107         | IXC code                              |
| 108             | Space                                 |
| 109             | BCC                                   |
| 110             | Space                                 |
| 111             | MA-UUI                                |
| 112             | Space                                 |
| 113             | Resource flag                         |
| 114             | Space                                 |
| 115–118         | Packet count                          |
| 119             | Space                                 |
| 120             | TSC flag                              |
| 121             | Space                                 |
| 122–123         | Bandwidth                             |
| 124             | Space                                 |
| 125–130         | ISDN CC (digits 1–6)                  |
| 131–135         | ISDN CC (digits 7–11)/PPM count (1–5) |
| 136–146         | Reserved for future use               |
| 147             | Carriage return                       |
| 148             | Line feed                             |
| 149–151         | Null                                  |

**Table 4-62. CDR Data Format — Unformatted**

| Position | Data Field Description                      |
|----------|---|
| 1-2      | Time of day-hours                           |
| 3-4      | Time of day-minutes                         |
| 5        | Duration-hours                              |
| 6-7      | Duration-minutes                            |
| 8        | Duration-tenths of minutes                  |
| 9        | Condition code                              |
| 10-13    | Access code dialed                          |
| 14-17    | Access code used                            |
| 18-32    | Dialed number                               |
| 33-42    | Calling number                              |
| 43-57    | Account code                                |
| 58-64    | Authorization code                          |
| 65-66    | Space                                       |
| 67       | FRL   |
| 68-70    | Incoming circuit ID (hundreds, tens, units) |
| 71-73    | Outgoing circuit ID (hundreds, tens, units) |
| 74       | Feature flag                                |
| 75-76    | Attendant console                           |
| 77-80    | Incoming TAC                                |
| 81-82    | Node number                                 |
| 83-85    | INS   |
| 86-88    | IXC   |
| 89       | BCC   |
| 90       | MA-UUI                                      |
| 91       | Resource flag                               |
| 92-95    | Packet count                                |
| 96       | TSC flag                                    |
| 97-100   | Reserved                                    |
| 101      | Carriage return                             |
| 102      | Line feed                                   |
| 103-105  | Null  |

**Table 4-63. CDR Data Format — Enhanced Unformatted**

| Position | Data Field Description                |
|----------|---------------------------------------|
| 1-2      | Time of day-hours                     |
| 3-4      | Time of day-minutes                   |
| 5        | Duration-hours                        |
| 6-7      | Duration-minutes                      |
| 8        | Duration-tenths of minutes            |
| 9        | Condition code                        |
| 10-13    | Access code dialed                    |
| 14-17    | Access code used                      |
| 18-32    | Dialed number                         |
| 33-42    | Calling number                        |
| 43-57    | Account code                          |
| 58-64    | Authorization code                    |
| 65-66    | Time in queue                         |
| 67       | FRL                                   |
| 68-70    | Incoming circuit ID                   |
| 71-73    | Outgoing circuit ID                   |
| 74       | Feature flag                          |
| 75-76    | Attendant console number              |
| 77-80    | Incoming TAC                          |
| 81-82    | Node number                           |
| 83-87    | ISDN NSV                              |
| 88-89    | IXC code                              |
| 90       | BCC                                   |
| 91       | MA-UUI                                |
| 92       | Resource flag                         |
| 93-96    | Packet count                          |
| 97       | TSC flag                              |
| 98-99    | Bandwidth                             |
| 100-105  | ISDN CC (digits 1-6)                  |
| 106-110  | ISDN CC (digits 7-11)/PPM count (1-5) |
| 111-114  | Reserved for future use               |
| 115      | Carriage return                       |
| 116      | Line feed                             |
| 117-119  | Null                                  |

**Table 4-64. CDR Data Format — Int Process**

| Position | Data Field Description           |
|----------|----------------------------------|
| 1–2      | Format code                      |
| 3–4      | Time of day-hours                |
| 5–6      | Time of day-minutes              |
| 7        | Duration-hours                   |
| 8–9      | Duration-minutes                 |
| 10       | Duration-tenths of minutes       |
| 11       | Space                            |
| 12       | Condition code                   |
| 13       | Space                            |
| 14–16    | Access code dialed               |
| 17–19    | Access code used                 |
| 20       | Space                            |
| 21–38    | Dialed number (digits 1–18)      |
| 39–43    | Calling number (digits 1–5)      |
| 44       | Space                            |
| 45–59    | Account code (digits 1–15)       |
| 60       | Space                            |
| 61       | IXC                              |
| 62       | FRL                              |
| 63–65    | Space                            |
| 66–67    | Incoming circuit ID (digits 1–2) |
| 68–70    | Space                            |
| 71–72    | Outgoing circuit ID (digits 1–2) |
| 73       | Space                            |
| 74–78    | PPM count (digits 1–5)           |
| 79       | Carriage return                  |
| 80       | Line feed                        |
| 81–83    | Null                             |

**Table 4-65. CDR Data Format — Int-Direct**

| <b>Position</b> | <b>Data Field Description</b> |
|-----------------|-------------------------------|
| 1–2             | Day of month                  |
| 3–4             | Month                         |
| 5–6             | Year                          |
| 7               | Space                         |
| 8–9             | Time of day-hours             |
| 10–11           | Time of day-minutes           |
| 12              | Space                         |
| 13              | Duration-hours                |
| 14–15           | Duration-minutes              |
| 16              | Duration-tenths of minutes    |
| 17              | Space                         |
| 18              | Condition code                |
| 19              | Space                         |
| 20–22           | Access code dialed            |
| 23–25           | Access code used              |
| 26              | Space                         |
| 27–44           | Dialed number used            |
| 45              | Space                         |
| 46–50           | Calling number                |
| 51              | Space                         |
| 52–66           | Account code                  |
| 67              | Space                         |
| 68–72           | PPM count                     |
| 73              | Space                         |
| 74–75           | Incoming circuit ID           |
| 76              | Space                         |
| 77–78           | Outgoing circuit ID           |
| 79              | Carriage return               |
| 80              | Line feed                     |

**Table 4-66. CDR Data Format — Int-ISDN**

| <b>Position</b> | <b>Data Field Description</b>  |
|-----------------|--------------------------------|
| 1–2             | Time of day-hours              |
| 3–4             | Time of day-minutes            |
| 5               | Space                          |
| 6               | Duration-hours                 |
| 7–8             | Duration-minutes               |
| 9               | Duration-tenths of minutes     |
| 10              | Space                          |
| 11              | Condition code                 |
| 12              | Space                          |
| 13–16           | Access code dialed             |
| 17              | Space                          |
| 18–21           | Access code used               |
| 22              | Space                          |
| 23–37           | Dialed number                  |
| 38              | Space                          |
| 39–48           | Calling number                 |
| 49              | Space                          |
| 50–64           | Account code                   |
| 65              | Space                          |
| 66–72           | Authorization code             |
| 73              | Space                          |
| 74              | Line feed                      |
| 75              | Space                          |
| 76              | FRL                            |
| 77              | Space                          |
| 78              | Incoming circuit ID (hundreds) |
| 79              | Incoming circuit ID (tens)     |
| 80              | Incoming circuit ID (units)    |
| 81              | Space                          |
| 82–84           | Outgoing circuit ID            |
| 85              | Space                          |
| 86              | Feature flag                   |

*Continued on next page*

**Table 4-66. CDR Data Format — Int-ISDN — *Continued***

| Position | Data Field Description        |
|----------|-------------------------------|
| 87       | Space                         |
| 88–89    | Attendant console (1st digit) |
| 90       | Space                         |
| 91–94    | Incoming trunk access code    |
| 95       | Space                         |
| 96–97    | Node number                   |
| 98       | Space                         |
| 99–101   | INS                           |
| 102      | Space                         |
| 103–106  | IXC                           |
| 107      | Space                         |
| 108      | BCC                           |
| 109      | Space                         |
| 110      | MA-UUI                        |
| 111      | Space                         |
| 112      | Resource flag                 |
| 113      | Space                         |
| 114–119  | Reserved                      |
| 120–124  | PPM or reserved               |
| 125–131  | Space                         |
| 132      | Carriage return               |
| 133      | Line feed                     |
| 134–136  | Null                          |



## Call detail record field description

The following list describes the CDR data collected for each call and the number of digits in each field. All information is right adjusted in the respective field, unless otherwise indicated. Where the field name for customized records is different from the standard, the custom field name appears in parentheses.

- **Access Code Dialed** (code-dial) — 3 or 4 digits

The access code the user dialed to place an outgoing call. This can be the ARS access code, AAR access code, or the access code of a specific trunk group. This field is also used to record the X.25 Feature Access Code of an outgoing X.25-addressed call.

- **Access Code Used** (code-used) — 3 or 4 digits

This field is used only for outgoing calls when the trunk group used is different from the access code dialed. It is not used when a TAC is dialed. For example, your system may use a feature access code for ARS. This field contains the access code of the actual trunk group that the call was routed over. When the dialed and used access code are the same, this field will be blank.

If you use ISDN or enhanced formats with TELESEER, LSU, or Printer record types, this field always shows the access code of the trunk group, even if it is the same as the access code dialed.

- **Account Code** (acct-code) — up to 15 digits

This field may contain a number to associate call information with projects or account numbers. For some formats, a long account code overwrites spaces on the record that are assigned to other fields.

- **Attendant Console** (attd-console) — 2 digits

This field contains the attendant console number of the attendant that handled the call in a record that is marked as being attendant handled.

- **Authorization Code** (auth-code) — 4–7 digits

This field contains the authorization code used to make the call. For non-ISDN and ISDN LSU formats, the authorization code is fewer than 6 digits in length. It is 5 for Enhanced LSU. On the 59-character record, the authorization code is never recorded.

- **Bandwidth** — 2 digits

Used to capture the bandwidth of the wideband calls to support H0, H11, H12, and N x 64 kbps data rates. For Enhanced Expanded, Enhanced Unformatted and customized record formats, this value is expressed as the number of DSOs of 64 Kbps channels comprising a call.

■ **Bearer Capability Class (bcc)** — 1 digit

This field contains the BCC for ISDN calls, identifying the type of an ISDN call. It will distinguish between voice and different types of data. The BCC is a single digit. Any one of the following may appear in this field.

- 0 = Voice Grade Data and Voice
- 1 = Mode 1 (56 kbps synchronous data)
- 2 = Mode 2 (less than 19.2 kbps synchronous or asynchronous data)
- 3 = Mode 3 (64 kbps data for LAPD protocol)
- 4 = Mode 0 (64 kbps data clear)
- w = Wideband

Intraswitch CDR outputs a value in this field for Wideband calls only.

■ **Calling Number (calling-num)** — up to 10 digits

For outgoing or intraswitch calls, this field contains the extension number of the originating voice-terminal user. For incoming and tandem calls, this field contains the TAC in standard formats. The fifth digit is the first digit of a 5-digit dialing plan. In formats where the field is less than 7 digits, this also shows the TAC of the incoming call.

This field shows the calling party number in Unformatted or Expanded records. If the CPN is not available, this field is blank for both formats.

This field contains the local extension of the NCA-TSC endpoint when the CDR record is for an outgoing (or originating) NCA-TSC. This field is blank for other NCA-TSC CDR records (that is, terminating, tandem, or unsuccessful).

■ **Calling Number/Incoming TAC (clg-num/in-tac)**

You can use this field on a customized record to display the calling number if it is available. If calling party number is not available, this field contains the Incoming TAC. For outgoing calls, this field contains the calling extension.

■ **Carriage Return (return)**

The ASCII carriage return character followed by a line feed indicates the end of a call record.

■ **Condition Code** — 1 character

The condition code indicates what type of call this record describes. For example, condition code C indicates a conference call, 7 indicates an ARS call, etc.

[Table 4-67](#) shows condition codes for most record formats. The 59-character format uses different condition codes from those used for other record types. The codes that apply to 59-character records appear in parentheses in the table.

**Table 4-67. Condition Codes**

| Condition Codes | Description  |
|-----------------|--|
| 0               | Identifies an intraswitch call (a call that originates and terminates on the switch).  |
| 1 (A)           | Identifies an attendant-handled call or an attendant-assisted call (except conference calls).  |
| 4 (D)           | Identifies an extremely long call (10 hours or more) or an extremely high message count TSC (9999 messages or more). On a call exceeding 10 hours, a call record with this condition code and a duration entry of 9 hours, 59 minutes, and 1–9 tenths of a minute is produced after the first period. A similar call record with this condition code is produced after each succeeding 10-hour period. When the call does terminate, a final call record with a different condition code identifying the call type is produced.  |
| 6 (E)           | Identifies calls that are not recorded because of resource exhaustion. A record with this condition code is only generated for calls that are routed to the attendant or calls that require CDR to overwrite records. This record includes the time and duration of the outage.  |
| 7 (G)           | Identifies calls served by the AAR or ARS Selection feature.   |
| 8 (H)           | Identifies calls which have been served on a delayed basis via the Ringback Queuing feature.   |
| 9 (I)           | Identifies an incoming or tandem call, or an incoming or tandem NCA-TSC.   |
| A               | Identifies an outgoing call.   |
| B               | Identifies an adjunct-placed outgoing call.  |
| C (L)           | Identifies a conference call. For trunk CDR, a separate call record with this condition code is produced for each incoming or outgoing trunk serving the conference connection. The only voice terminal recorded for a conference call is the conference call originator, provided ITCS and OTCS are disabled. For intraswitch CDR, if the originator is optioned for intraswitch, each time the originator dials a non-trunk party a separate call record is produced with this condition code, provided ITCS is disabled. If the originator is not optioned for intraswitch CDR, a separate record with this condition code is produced for each intraswitch party dialed. |

*Continued on next page*

Table 4-67. Condition Codes — Continued

| Condition Codes | Description  |
|-----------------|--|
| E (N)           | An ineffective call attempt due to facilities not being available, such as all trunks are busy and either no queuing exists or the queue is full on an outgoing call, or the called voice terminal is busy or unassigned for an incoming call attempt. This also means an ISDN Call By Call Service Selection call was unsuccessful because of an administered trunk usage allocation plan. Incoming trunk calls to a busy terminal do <i>not</i> generate a CDR record. |
| F               | Identifies an ineffective call attempt because of either insufficient calling privileges of the originator (assigned per FRL), ISDN calls rejected by the switch due to an NSF mismatch, or an authorization mismatch which prevents the completion of a data call.  |
| G               | Indicates a call terminating to a ringing station.   |
| H               | Indicates that a ringing call has been abandoned.  |
| I               | Indicates a call terminated to a busy station.   |
| J               | Indicates an incoming trunk call that is a new connection using ANF-PR (Additional Network Feature–Path Replacement, see QSIG) or DCS with Rerouting.  |
| K               | Indicates an outgoing trunk call that is a new connection using ANF-PR (Additional Network Feature–Path Replacement, see QSIG) or DCS with Rerouting.  |

If the trunk-group field `CDR Reports` is set to **ring**, CDR records the ring time to answer or abandon for incoming calls originated by the trunk group. In addition, CDR indicates if the incoming destination is busy. This record is separate from the normal call duration record printed for an answered call. This information is indicated by the condition code.

When an incoming call originated by a trunk group with this option set is terminated to an internal destination, the call is tracked from the time ringing feedback is given to the originator. If the call is answered, a CDR record is printed with the condition code "G" and the duration reflects the time between the start of ringing and the answer of the call. If the call is abandoned before being answered, the system prints a record with the condition code "H" and the duration reflects the time between the start of ringing and the time the call was abandoned. If the destination is busy, a CDR record is printed with the condition code "I" and a duration of 0.

- Condition Code overrides

If two condition codes apply to the same call, one code overrides the other. The matrix below, [Table 4-68](#), defines the overrides. To use this matrix, assume that condition codes 7 and A apply to the same call. To find the condition code that overrides, look at the point of where row 7 intersects column A (or where row A intersects column 7). In this case, condition code 7 overrides.

**Table 4-68. Condition Code Override Matrix**

|   |    | CONDITION CODE |    |    |    |    |    |    |    |    |    |    |    |    |  |
|---|----|----------------|----|----|----|----|----|----|----|----|----|----|----|----|--|
|   | 0  | 1              | 4  | 6  | 7  | 8  | 9  | A  | B  | C  | E  | F  | J  | K  |  |
| 0 | NA | 0              | 4  | 6  | 0  | NA | NA | NA | B  | C  | NA | NA | NA | NA |  |
| 1 | 0  | NA             | 4  | 6  | 1  | NA | 9  | 1  | B  | C  | E  | NA | J  | K  |  |
| 4 | 4  | 4              | NA | 6  | 4  | 4  | 4  | 4  | 4  | 4  | NA | NA | J  | K  |  |
| 6 | 6  | 6              | 6  | NA | 6  | 6  | 6  | 6  | 6  | 6  | 6  | 6  | 6  | 6  |  |
| 7 | 0  | 1              | 4  | 6  | NA | 7  | 9  | 7  | B  | C  | E  | F  | J  | K  |  |
| 8 | NA | NA             | 4  | 6  | 7  | NA | NA | 8  | B  | C  | E  | NA | NA | K  |  |
| 9 | NA | 9              | 4  | 6  | 9  | NA | NA | NA | NA | C  | E  | F  | NA | NA |  |
| A | NA | 1              | 4  | 6  | 7  | 8  | NA | NA | B  | C  | E  | F  | NA | NA |  |
| B | B  | B              | 4  | 6  | B  | B  | NA | B  | NA | B  | E  | F  | NA | K  |  |
| C | C  | C              | 4  | 6  | C  | C  | C  | C  | B  | NA | NA | NA | J  | K  |  |
| E | NA | E              | NA | 6  | E  | E  | E  | E  | E  | NA | NA | NA | E  | E  |  |
| F | NA | NA             | NA | 6  | F  | NA | F  | F  | F  | NA | NA | NA | F  | F  |  |
| J | NA | J              | J  | 6  | J  | NA | NA | NA | NA | J  | E  | F  | NA | NA |  |
| K | NA | K              | K  | 6  | K  | K  | NA | NA | NA | K  | E  | F  | NA | NA |  |

- Date

You can include the date in customized records only. The format is based on the value of CDR Date Format on the CDR System Parameters form.

- Dialed Number (dialed-num) — up to 18 digits

This field contains the number dialed. If it is an outgoing call, the field contains the number dialed by a system user. If it is an incoming call, the field contains the extension that was dialed (or implied, as in Dialed Number Identification System). If more than 18 digits are dialed, the least significant digits (starting from the right) are truncated.

If CDR Privacy is active for the calling number and this is an outgoing call, the trailing digits of the dialed number are blank in the call record. If more than 18 digits are dialed, the system truncates the dialed number to 18 digits, then blanks the administered number of digits.

For an outgoing (or originating) NCA-TSC or tandem NCA-TSC, this field contains the dialed digits used to establish a route to a far-end switch. It contains the extension of the local extension used as the NCA-TSC endpoint when it is for a terminating NCA-TSC. For an unsuccessful NCA-TSC, this field is blank.

The # sign (or E for some formats) may appear in this field in the following cases for both ARS and TAC calls.

- When the user dials # at the end of digit dialing
- If an outgoing call experiences an interdigit-timeout interaction with the ARS Analysis table
- When a user dials a TAC for a Look Ahead Interflow (LAI). For example: A successful LAI to <TAC> 1001 where 1001 is the remote VDN extension will yield 1001E or 1001# in the Dialed Number field. The # or E is used by the vector processing software to indicate the end of dialing.

You can eliminate the # or E as the last digit of the CDR record using the CDR System Parameters form.

■ **Duration** (duration or sec-dur) — 4 digits

This is the duration of the call, recorded in hours (0–9), minutes (00–59), and to tenths of minutes (0–9). Calls are rounded down in 6-second increments. Therefore, a call of 5-second duration will be indicated as 0 duration. If 9999 appears in this field, this call was in progress when a time change was made in the switch.

You can use the customized record format to have the duration reported in hours/minutes/seconds. This field is called `sec_dur`.

■ **Feature Flag** (feat-flag) — 1 digit

The feature flag indicates whether a call received network answer supervision, and if the call was interworked in the network. The call duration starts at the point of receiving the network answer.

You can administer the feature flag (on the CDR System Parameters form) to reflect whether an outgoing ISDN call was reported as interworked by the network.

- A 0 in this field indicates a voice call without network answer supervision, or NCA-TSC not established.
- A 1 in this field indicates a data call without network answer supervision.
- A 2 in this field indicates a voice call with network answer supervision, but interworked.

- A 3 in this field indicates a data call with network answer supervision, but interworked.
- A 4 in this field indicates a voice call with network answer supervision.
- A 5 in this field indicates a data call with network answer supervision.

If the feature flag indicates that the call received network answer supervision, then the time of answer is accurate, and the recorded duration is also accurate. If a call does not receive network answer supervision, or receives answer supervision but is interworked with non-ISDN trunks, the time of answer is not necessarily accurate. Therefore the recorded duration for these calls may also not be entirely accurate.

Calls are considered data calls if they use a conversion resource (such as a modem) and/or originate or terminate on a data module.

■ **Format Code** — 2 digits

This field contains 2 values: 00 is no PPM; 03 denotes a PPM count in the digits record.

■ **FRL** — 1 digit

FRLs, numbered 0–7, are associated with the AAR and ARS features and define calling privileges. The information contained in this field is as follows:

- If the call is an outgoing call and an authorization code is not used to make the call, this field contains the originating voice-terminal user's FRL.
- If the call is an outgoing call and an authorization code is used to make the call, this field contains the FRL associated with the dialed authorization code.
- If the call is an incoming or tandem call, this field contains the FRL assigned to the incoming trunk group.
- If the call is an incoming tandem tie trunk call, this field contains either the FRL assigned to the tandem tie trunk or the raveling class mark (TCM) sent with the tandem tie trunk call, depending on which was used to complete the call. On ISDN calls, this field always contains the TCM, if it was received.

You can administer CDR so that disconnect information appears in this field in place of the FRL. If you do this, for trunk CDR, the following disconnect information appears:

| Data | Meaning                            |
|------|------------------------------------|
| 0    | Cannot determine who dropped first |
| 1    | Switch party dropped first         |
| 2    | CO dropped first                   |
| 3    | Maintenance seized the trunk       |

For intraswitch CDR, the following call disconnect data appears in this field in place of the FRL data:

| Data | Meaning                            |
|------|------------------------------------|
| 0    | Cannot determine who dropped first |
| 1    | Calling number dropped first       |
| 2    | Dialed number dropped first        |

- **Incoming Circuit Identification** (in-crt-id) — 3 digits

This field contains the member number of a trunk within a trunk group used for an incoming call. For outgoing calls, this field is blank. Tandem calls contain both incoming and outgoing circuit id-numbers.

The format of this field varies from record to record. For printer, Teleseer and 59-character formats, the numbers appear inverted on the record. For example, the circuit ID 123 appears as 231 (tens, units, hundreds). If you want to change this to appear in hundreds, tens, units format (123), use the `Modified Circuit ID Display` field on the CDR System Parameters form.

- **Incoming TAC** (in-trk-code) — 4 digits

This field contains the access code of the incoming trunk group.



- **INS** (3 digits)

This field specifies the ISDN Network Service requested for a call. This field applies only to ISDN calls. Each Network Specific Facility has a corresponding INS value, shown in [Table 4-69](#).

This field also appears as ISDN NSV (Network Service Value).

**Table 4-69. Network Specific Facility to INS Mapping**

| Network Specific Facility             | INS Value |
|---------------------------------------|-----------|
| OUTWATS Band 0                        | 33        |
| OUTWATS Band 1–255                    | 34–288    |
| Network Operator                      | 324       |
| Presubscribed Common Carrier Operator | 325       |
| Software Defined Network (SDN)        | 352       |
| MEGACOM 800                           | 353       |
| MEGACOM                               | 354       |
| INWATS                                | 355       |
| Maximum Banded WATS                   | 356       |
| ACCUNET Digital Service               | 357       |
| AT&T Long Distance Service            | 358       |
| International 800                     | 359       |
| Multiquest                            | 367       |

- **ISDN CC**

The call charge supplied by the ISDN advice of charge function (see [“Call Charge Information”](#) on page 4-136).

- **ISDN NSV**

See INS.

- **IXC Code**

- Non-ISDN Formats — 1 digit hexadecimal

Interexchange Carrier (IXC) codes, 1–F hexadecimal, indicate the carrier used on the call. This information is sent to the CDR output device in ASCII code as a hexadecimal representation (for example, ASCII “F” equals “15”).

Users must dial an IXC access number to access a specific common carrier for a call. In the US, this number is in the form 10XXX, 950 — 1XXX, or any 8–11 digit number. The IXC access numbers applicable at a given location are associated with an IXC code on the Inter-Exchange Carrier Codes form.

When ARS is used, and a route pattern inserts one of the administered IXC codes, the report contains the associated IXC code. If no IXC access number is used, or the carrier is selected at the CO, the report contains a 0.

— ISDN formats — 3 or 4 digits

With an ISDN record format, this field is a 3 or 4-digit field that identifies the actual IXC used on an ISDN call. This information is determined from the route pattern administration. For AAR and ARS calls, the 3-digit IXC value is administered in the route pattern for all ISDN calls. If a user dials an IXC code with a 10XXX format as administered on the Inter-Exchange Carrier Codes form, the CDR record contains only the last 3 digits (4 for Enhanced). If a user dials a 7-digit IXC code, this field contains a 0.

■ **Line Feed** — 1 character

The ASCII line feed character follows a carriage return to terminate CDR records.

■ **MA-UUI** — 1 digit

Message Associated User-to-User Signaling shows the number of ISDN messages containing user data sent on an outgoing call. Data in this field can range from 0 to 9.

■ **Node Number** (node-num) — 2 digits

This field identifies the DCS node number of a switch within a DCS arrangement. The number output is the same as the node number on the Dial Plan form (the local id).

■ **Null** — 1 character

The NULL is used to terminate and divide CDR Records (usually in triplets) when needed by the receiving adjunct.

■ **Outgoing Circuit Identification** (out-crt-id) — 3 digits

For outgoing calls, this field contains the member number of the trunk within a trunk group used. This field is blank for incoming calls. Tandem calls include both incoming and outgoing circuit id numbers. For outgoing and tandem NCA-TSCs, this field contains the signaling group used to carry the NCA-TSC.

The format of this field varies from record to record. For printer, Teleseer and 59-character formats, and the ISDN and enhanced forms of those records, the numbers appear inverted on the record. For example, the circuit ID 123 appears as 231 (tens, units, hundreds). If you want to

change this to appear in hundreds, tens, units format (123), use the Modified Circuit ID Display field on the CDR System Parameters form.

- **Packet Count** (tsc\_ct) — 4 digits

For ISDN TSCs, this field contains the number of ISDN-PRI USER INFO messages sent, received, or (for tandem TSCs) passing through the switch.

- **PPM**

Periodic Pulse Metering (PPM) contains pulse counts transmitted over the trunk line from the serving CO. These are used to determine call charges.

- **Resource Flag** (res\_flag) — 1 digit

Indicates whether the call was circuit switched or packet switched, whether a conversion resource was used, or if the call involved a MASI terminal or trunk.

- 0 — circuit switched, no conversion device used
- 1 — packet switched, no conversion device used
- 2 — circuit switched, conversion device used
- 3 — packet switched, conversion device used
- 8 — MASI call

- **Sec-dur**

For customized records only, this field allows you to set the duration field to display seconds instead of tenths of minutes.

- **Space** — up to 40 characters

The ASCII space character separates other CDR fields or fills unused record locations.

- **TSC-Count** (tsc\_ct)

This is the customized name for Packet Count. See Packet Count.

- **TSC Flag** (tsc\_flag) — 1 digit

This field describes call records that pertain to temporary signalling connections. When not equal to 0, this field will indicate the status of the TSC. [Table 4-70](#) presents the TSC Flag encoding.

**Table 4-70. Encoding for TSC Flag**

| Encoding | Meaning   |
|----------|---|
| 0        | Circuit-switched call without TSC requests  |
| 1–3      | Reserved  |
| 4        | Call Associated TSC requested and accepted in response to SETUP, no congestion control (applicable to originating node). Call Associated TSC received and accepted via SETUP, no congestion control (applicable to terminating node). |
| 5        | Call Associated TSC received and accepted via SETUP, congestion control (applicable to terminating node).   |
| 6        | Call Associated TSC requested, accepted after SETUP, no congestion control (applicable to originating node). Call Associated TSC received and accepted after SETUP, no congestion control (applicable to terminating node).           |
| 7        | Call Associated TSC received and accepted after SETUP, congestion control (applicable to terminating node).   |
| 8        | Call Associated TSC requested, rejected (rejection came from outside the local switch).   |
| 9        | Call Associated TSC requested, rejected (rejection came from the local switch, that is, lack of resource).  |
| A        | Non Call Associated TSC received, accepted, no congestion control (applicable to terminating node). Non Call Associated TSC received, accepted, no congestion control (applicable to terminating node).                               |
| B        | Non Call Associated TSC requested, accepted, congestion control (applicable to originating node). Non Call Associated TSC received, accepted, congestion control (applicable to terminating node).                                    |
| C        | Non Call Associated TSC requested, rejected (rejection came from outside the local switch).   |
| D        | Non Call Associated TSC requested, rejected (rejection came from the local switch, that is, lack of resource).  |
| E        | Reserved for future use.  |
| F        | Reserved for future use.  |

- **Time**

This field contains the time that the call ended, or the time that a user dropped from a multi-party call, if Call Splitting is active.

- **VDN (vdn) — 5 digits**

This field is only available on customized records. The call record contains the VDN extension number. If VDN Return Destination is active, this field contains the first VDN the caller accessed.

## Security

Monitor call detail records daily for unusual calling patterns, long calls, international calls, calls outside of normal business hours, and other indications of toll fraud. Call accounting systems are available that automatically monitor CDR output for fraudulent calling patterns.

## Considerations

- **Date and Time**

If a time of day is not administered in the system, DEFINITY ECS does not generate CDR records. If the time is changed while a call is in progress, the actual duration for that call is not reflected in the CDR record. Instead, a special sequence of 9999 is recorded in the CDR record to indicate that the call was in progress during a time change.

## Interactions

- **Abbreviated Dialing**

When a user places a call using Abbreviated Dialing or a Facility Busy Indication button, all outpulsed digits appear on the record.

- **Answer Detection**

The DEFINITY ECS provides Answer Detection using a Call Classifier circuit pack. This feature is assigned as an option per system and requires 8-port circuit packs. The circuit packs must be engineered to handle the expected outgoing calls from end of outpulsing until either answer is detected by the circuit pack or actual Answer Supervision is received from the trunk. The time the answer is detected by the circuit pack is used as the start of a call to record call duration in the CDR record.

- **Attendant Console**

If an attendant-assisted call involves an outgoing trunk, the primary extension of the voice-terminal user requesting attendant service is recorded as the calling number, even if the attendant dialed the outside number. Condition Code 1 indicates the call was assisted by the attendant.

If the attendant allows through dialing, the primary extension of the voice-terminal user who dialed the number is recorded as the calling party. Condition Code 1 indicates that a trunk access code was extended by the attendant. Condition Code 7 indicates that a feature access code was extended by the attendant.

If Incoming or Outgoing Attendant Call Record is enabled, the system produces a separate record for the attendant portion of incoming or outgoing calls that are transferred.

On attendant-assisted calls that require an account code, the account code must be entered before the trunk access code.

If the attendant is redirecting an incoming call to a voice terminal, the attendant may dial an account code before dialing the extension number.

It is not possible to option the attendant for intraswitch calls. Intraswitch records are produced for an intraswitch-optioned extension calling the attendant or for a call from the attendant to an intraswitch-optioned extension. In the case of an attendant-assisted call involving an intraswitch extension, the calling number recorded is the extension of the party who called the attendant, and the dialed number recorded is the extension that the attendant extended the call to. The record has a Condition Code 0.

- AUDIX

For remote AUDIX over DCS, if station A on node 1 forwards its calls to AUDIX on node 2, each switch produces a call record. The record from node 1 contains A as the dialed number. The record from node 2 contains AUDIX as the dialed number. If the calling number is on a different switch within the DCS network, or the call comes in over ISDN, the actual calling number is recorded in the `Calling Number` field, and the TAC of the trunk bringing the call into the local switch is recorded in the `Incoming Trunk Access Code` field of 24-word records. If the forwarded call is an incoming call, then, as in all cases (other than vectoring) in which an incoming call is forwarded, transferred, or conferenced using an outgoing trunk, two separate CDR records are produced, one for incoming and one for outgoing trunk usage. The outgoing trunk usage record lists AUDIX as the `Calling Number`.

- Authorization Codes

Authorization codes are recorded on CDR records if account codes do not exceed 5 digits for both non-ISDN and ISDN LSU formats and 4 digits for Enhanced LSU formats. On the 59-character CDR International Processing and International Direct records, the authorization code is never recorded. When account codes are dialed, for the non-ISDN and the ISDN LSU formats, authorization codes are recorded on CDR printouts if the account code length does not exceed 6 digits. For Enhanced LSU, the account code length must not exceed 6 digits.

- AAR and ARS

CDR records contain the following information for Automatic Route Selection (ARS):

- Fact that an ARS call was made
- Calling extension number
- FRL of the calling extension
- Called number
- TAC of trunk group used for the ARS call
- Time of call completion
- Call duration (how long the parties talked)
- IXC code, if any

If CDR is suppressed for the trunk group actually used on an ARS call, a CDR record is not generated; otherwise, Condition Code 7 applies. The ARS access code is recorded in the `Access Code Dialed` field and the trunk access code for the trunk group actually used is recorded in the `Access Code Used` field.

If an AAR call is placed to a busy trunk group and CDR is suppressed for that trunk group, the user hears reorder tone and the CDR output shows an ineffective call attempt.

If an ARS call is an attendant-assisted call, the CDR record shows the call with a Condition Code of 7 (ARS call) instead of a Condition Code of 1 (attendant-assisted call). This occurs because CDR is not notified until after the trunk is seized and, in this case, the trunk is not seized until the voice-terminal user dials the number.

For FEAC, if a trunk group is accessed via ARS, the trunk group's COR is not used to determine if an account code needs to be entered.

- Automatic Callback

When the Automatic Callback feature is used for an intraswitch call, no CDR record is generated for the first call attempt or the ringback. However, if the caller or extension being called is optioned for intraswitch CDR, a record of the actual call is output provided the call is answered and completed.

- Automatic Circuit Assurance

ACA calls generate intraswitch CDR if the terminating extension is monitored by CDR. The originating extension for ACA calls cannot be administered for intraswitch monitoring.

- Automatic Wakeup

No CDR intraswitch records are generated for wakeup calls.

- Bridged Call Appearance

CDR does not record any information on the party who bridges onto a call. Instead, the number that was called appears in the `Dialed Number` field of the CDR record. The duration of the call is recorded when the last party drops off the call. This also applies for intraswitch calls.

If the user originates a call over a bridged appearance, the call record contains the calling number of the bridged appearance extension and not the extension number of the original, calling station.

- Busy Verification of Terminals and Trunks

An attendant or voice-terminal user is never required to enter an account code when making a busy verification.

- Call-by-Call Service Selection

When a successful call is made on a Call-by-Call Service Selection trunk, the network specific facility used on the call is translated into an `INS` number and recorded in the `INS` field of the call record. If a Call-by-Call Service Selection call is unsuccessful because of an administered trunk usage allocation plan, the `INS` number is recorded in the `INS` field of the report with a condition code of "E."

- Call Coverage

When an incoming or intraswitch call is answered by a covering voice terminal, the extension number dialed by the originating party is recorded as the dialed number. If a call is covered to an off-net location, the dialed number is the number of the off-net location, the calling number is the number of the station that is covered to the remote location.

- Call Forwarding All Calls

When a call is forwarded to another voice terminal, the extension number dialed by the calling party is recorded as the dialed number. If a call is forwarded to an off-net location, the dialed number is the number of the off-net location, the calling number is the number of the station that is forwarded to the remote location.

CDR generates one record for a forwarded intraswitch call. In this record, the dialed number is the same as the extension dialed by the originating party.

For a trunk call to a station that is forwarded to a trunk, CDR generates two records. The first record shows an incoming trunk call to the station. The second record shows an outgoing trunk call from the station.

For FEAC, calls cannot be forwarded to a destination where a user is required to enter an account code.



- Call Park

When a voice-terminal user parks an incoming or intraswitch call, that user's extension is recorded as the dialed number in the CDR record. Call duration in CDR reflects the entire time the incoming trunk is busy (incoming) or until the call ends (intraswitch).

- Call Pickup

When an incoming or intraswitch call is answered by another voice-terminal user in the pickup group, the extension number dialed by the calling party is recorded as the dialed number.

- Call Vectoring

The CDR System Parameters form can be administered so that the VDN extension is used in place of the Hunt Group or Member extension. If administered to do so, this overrides the *Calls to Hunt Group - Record* option of CDR for incoming Call Vectoring calls.

Outgoing vector calls generate ordinary outgoing CDR records with the originating extension as the calling number.

For incoming calls to a VDN, the duration of the call is recorded from the time answer supervision is returned.

- If answer supervision is returned by the vector (via an announcement, collect, disconnect, or wait with music command), and the call never goes to another extension, the VDN extension is recorded as the called number in the CDR record.
- If the call terminates to a hunt group, the VDN, hunt group, or agent extension is recorded as the called number as per the administration discussed above.
- If the call terminates to a trunk, CDR generates the following two records:
  - An incoming record with the incoming TAC as the dialed number.
  - An outgoing record with the incoming TAC as the calling number and the digits dialed through the vector step as the dialed number.

If "member extensions" is administered on the CDR System Parameters form and the call successfully completes to a station via the "route-to" command, the call record shows an incoming call to that station.

Call Vectoring "route to" commands that are unsuccessful do not generate ineffective call attempt records.

If a vector interacts with an extension or group that has Call Forwarding All Calls active, normal Call Forwarding/CDR interactions apply.

Some calls may originally look like intraswitch calls, but result in trunk calls (for example, a call from a station administered for intraswitch CDR to a VDN, which ends up an outgoing call on an outgoing trunk). Such calls will not generate intraswitch CDR records; the CDR record will have a condition code A - outgoing.

- Call Waiting Termination

Call duration timing starts when the voice terminal answers an incoming call.

- Centralized Attendant Services

If a CAS attendant extends a call for a user, and CDR is not assigned to the RLT trunk group, the user's extension is recorded as the originator of the call. If the RLT trunk group does have CDR administered, the RLT trunk is recorded. If a CAS attendant answers a call but does not extend the call, no CDR records are made.

- CO Trunks

All incoming and outgoing calls on a CO trunk group are recorded, if CDR is assigned to the trunk group and CDR is administered to record incoming calls.

- Conference

For the purpose of CDR, a call is considered a conference call if it contains at least one trunk that is eligible for CDR plus two or more parties, or if it contains at least one party optioned for intraswitch CDR. Condition Code C applies to each CDR record made for a conference call.

For a conference call, a separate CDR record is produced for each outgoing/incoming trunk serving the conference call. If ITCS or OTCS is enabled, CDR produces a separate record for each internal party on the call as well.

For the outgoing portion of a conference call involving multiple voice terminals, the voice terminal which requested outside dial tone to bring an outside party into the conference is recorded as the calling party.

For the outgoing/incoming portion of a conference call, the call duration in CDR reflects the entire time the trunk is on the conference call.

A separate CDR record is produced for each trunk used in a trunk-to-trunk transfer. If ITCS is active, the incoming trunk record shows the duration of the entire call.

If the originator of the conference call is optioned for intraswitch CDR, each time the originator dials a non-trunk party, a new CDR record is started. For example, Station A is optioned for intraswitch CDR and calls Station B. Station A conferences in Station C. Station A drops from the call. Station B or C drops from the call. Two CDR records are output with Condition Code C: one for the A to B call and one for the A to C call.

If the originator is not optioned for intraswitch CDR, but one or more parties brought into the conference are, one record with Condition Code C is generated for each dialed intraswitch party. For example, Station A calls Station B, which is optioned for intraswitch CDR. Station A conferences Station C. Station A drops from the call. Station B or C drops from the call. One CDR record is output with condition code C for the A to B call.

Intraswitch conference call CDR records are output when both the calling number (originator) and dialed number (terminator) of the call drop. The duration of the call will be from the time the terminator answers until both the originator and terminator drop from the call.

If the attendant originates the conference, only the dialed numbers corresponding to intraswitch optioned extensions stimulate the creation of CDR records.

- DCS

Station information is not passed throughout the DCS network for CDR purposes.

- DID trunks

All incoming calls on the DID trunk group will be recorded if administered to record incoming CDR and if CDR is administered for this trunk group.

- Emergency Access to the Attendant

CDR does not generate intraswitch records for Emergency Access calls.

- Expert Agent Selection

A logical extension can be assigned to an agent who can log into a phone using that extension number. On the CDR System Parameters form, you can choose to record the logical agent's extension rather than the hunt-group extension or hunt-group-member extension.

- FX Trunks

All calls made on an FX trunk group are recorded if administered to record CDR and if CDR is administered for this trunk group.

- Hotline Service

The stored number used on an outgoing or intraswitch Hotline call is recorded by CDR the same as if it was manually dialed.

- Hunt Groups

Either the hunt group extension number or individual hunt group member extension number is recorded as the called number. This is administrable on the CDR System Parameters form.

- Intercept Treatment

If an outgoing or tandem call is routed to Intercept Treatment, the number dialed by the calling party is recorded as the dialed number, and Condition Code F is recorded.

- Intercom — Automatic  
Intercom calls can generate intraswitch CDR records.
- Intercom — Dial  
Intercom calls can generate intraswitch CDR records.
- Inter-PBX Attendant Calls  
If a user calls an Inter-PBX attendant and the trunk group used has CDR assigned, call records contain the following information:
  - Condition Code — A
  - Access Code Dialed — Blank
  - Access Code Used — Trunk access code of trunk used
  - Dialed Digits — Inter-PBX attendant access code
- ISDN  
When true answer supervision is received from the network, an indication is sent to the CDR device to this effect. If an ISDN call has been interworked, the call record shows this, and answer supervision may or may not be accurate. If you use unformatted or expanded record formats, the SID/ANI appears in the record, if sent.
- Last Number Dialed  
The CDR access code and account code dialed are stored as part of the Last Number Dialed. However, some digits may be lost due to the limit on the number of digits stored for this feature.
- Manual Originating Line Service  
If an attendant establishes an outgoing call for a voice terminal, designated as a Manual Originating Line, the CDR record for the call is the same as for any attendant-assisted outgoing call. The calling voice terminal extension number is recorded as the calling number, and Condition Code 1 applies.
- Multiple LDNs  
If incoming call information is recorded, the called number recorded for LDN calls is the extension number or trunk group access code to which the attendant completes the call. If the call terminates at the attendant console only, the dialed number is the attendant extension. The attendant extension number is administrable (the default is 0).  
  
LDNs cannot be administered for intraswitch CDR. However, a call from an intraswitch optioned extension to a LDN produces an intraswitch CDR.
- Night Service  
The extension number assigned to the attendants is recorded as the dialed number. The attendant extension number is administrable (the default is 0).

- Off-Premises Station

CDR data is recorded if the voice terminal is involved in an outgoing/incoming trunk call or it (or the other terminal involved in the call) is optioned for intraswitch CDR.
- PCOL trunks

An outgoing PCOL call shows the dialed number in the `Dialed Number` field of the CDR record rather than a TAC. An outgoing PCOL call is recorded as a call from the originating extension number via the trunk group associated with the PCOL. On incoming PCOL calls the answering voice terminal's primary extension is recorded as the called number if incoming calls are recorded.
- Planned Interchange

When a planned interchange occurs (either demand or scheduled), it is possible for the CDR records on calls ending within 10–20 seconds after the interchange to report as “invalid long duration calls” (duration of 9:59:9 and Condition Code other than 4). This is caused by deviations in the clocks between the two processors and the short duration of the calls. Consider these records invalid.
- Private Network Access

Private Network Access calls are recorded if CDR is assigned for incoming or outgoing tie trunks.
- Remote Access

Remote Access calls are recorded if Remote Access is provided on a per trunk group basis, and those trunks are administered for CDR. The call record gives no indication that this is a remote access call, other than the remote access extension.
- Ringback Queuing

Condition Code 8 is recorded for an outgoing call which is queued for a trunk before completion. The length of time the call is queued is not recorded.

When an outgoing call is queued for a trunk and is unsuccessful (the queue times out or the calling party does not answer the callback) a CDR record is not generated for the call.
- Security Violation Notification

SVN calls generate intraswitch CDR if the terminating extension is monitored. You cannot administer the originating extension for intraswitch monitoring.
- Service Observing

No CDR records are generated for Service Observing calls. Tandem Tie-Trunk Switching

The calling party on an incoming trunk can dial the CDR account code. The `Calling Number` field in CDR is the trunk access code for the incoming trunk group, the called number is the number dialed.

- Temporary Bridged Appearance

A CDR record is not affected by any second or subsequent voice terminal bridging a call.

- Temporary Signaling Connections

Cal-associated TSCs and TSC requests appear in the call record, provided the switch is administered to use ISDN layouts.

Non-call-associated TSCs and TSC requests generate separate CDR records if the switch is administered to record them. In either case, the `TSC Flag` and `Packet Count` fields of the call record contain TSC data.

- Tie Trunk Access

Tie-trunk calls are recorded if CDR is administered to record the trunk group and to record incoming calls.

- Transfer

If a user *originates* a call on an outgoing trunk and then transfers the call to another voice terminal, the originating voice terminal is recorded as the calling party.

If a voice-terminal user *receives* a call on an incoming trunk and then transfers the call to another extension, the extension that originally received the call is recorded as the dialed number.

If a voice-terminal user *receives an intraswitch call* and then transfers it to another extension, the extension that originally received the call is recorded as the dialed number.

If call splitting is active, when a user receives or originates a trunk call and then transfers the call to another voice terminal, two records are generated.

Intraswitch CDR records are generated for each call to or from an intraswitch optioned extension. For example, Station A, which is intraswitch optioned, calls Station B. Station A then transfers the call to Station C. When either Station B or C drops, two CDR records with Condition Code 0 are output: one for the A to B call, and the second for the A to C call.

Intraswitch CDR transfer records are output when both the calling number (originator) and dialed number (terminator) drop from the call. The duration of the call is from the time the terminator answers until both the originator and terminator have dropped from the call.

If ITCS is enabled and an incoming trunk call is transferred to a local extension that is optioned for Intraswitch CDR, the call produces an incoming trunk call record. It does not produce an Intraswitch record.

Voice-terminal users cannot dial an account code when transferring a call to another voice terminal, unless they have console permissions. However, a voice-terminal user transferring a call to a trunk can dial an account code before dialing the ARS or TAC.

- Trunk-to-Trunk Transfer

Although they are not really conference calls, Trunk-to-Trunk Transfer connections are treated as such for CDR purposes. A separate CDR record is generated for each trunk in the connection.

Unanswered Trunk Calls may or may not be recorded depending on administration. Each trunk group can be administered so that unanswered calls will be recorded if they remain unanswered for a specified period of time.

If Incoming Trunk Call Splitting is active, a trunk-to-trunk transfer produces a record of the incoming call, and a record of the outgoing call. The outgoing call record shows the duration from the time the call was transferred until both parties drop. The incoming call record shows the duration from the time the station receives the incoming trunk call until both parties drop.

- Uniform Dial Plan

If one user calls another user via a UDP extension number, and the trunk group used has CDR assigned, CDR records the following information:

- Condition Code — 7
- Access Code Dialed — blank
- Access Code Used — trunk access code of trunk used
- Dialed Digits — Uniform Dial Plan extension

- VDN Return Destination

An incoming call does not generate a CDR record until the originator drops from the call. CDR creates a record when a call goes to the return destination VDN, the originator has not dropped, and vector processing — that is, the return destination VDN — routes the call to an outgoing trunk. CDR does not create a record if vector processing routes a call from the return destination VDN to an internal call. The call record shows only the first VDN that the caller accessed, no matter how many other extensions are involved in the call.

If an incoming VDN call is routed to a station, CDR includes the station in the record. If an incoming VDN call is routed to an outgoing trunk, CDR includes the VDN in the record.

- WATS and 800 Service

Calls made on a WATS or 800 Service trunk group are recorded, if CDR is administered for the trunk group.

## Call Forwarding

---

Call Forwarding allows users to redirect calls to designated destinations. The forwarded-to destination can be an internal extension, external (off-net) number, an attendant group, or a specific attendant.

Call Forwarding provides five functions:

- Call Forwarding-All Calls — Allows a user to redirect every incoming call to the forwarded-to destination.
- Call Forward Busy/Don't Answer — Allows a user to redirect incoming calls to a forwarded-to destination only when the user is busy or when the call is not answered after an administrable interval. If the extension is busy, the call forwards immediately. If the extension is not busy, the incoming call rings the called extension, then forwards only if it remains unanswered longer than the administered interval.
- Call Forwarding Off Net— Allows a user to forward calls to an off-net destination.
- When Coverage of Calls Redirected Off-Net is activated, calls can be monitored for call progress tones, and if a call is not answered, it is returned to the switch for call coverage processing in some circumstances.
- Call Forwarding Override — Allows the user at the forwarded-to extension to override Call Forwarding at the forwarded-from extension on a per-call basis so the user can initiate a call or transfer a call back to the forwarded-from extension.

## How to administer Call Forwarding

---

### Required forms

| Form                              | Field  | Page                  |
|-----------------------------------|--|-----------------------|
| Feature-Related System Parameters | ■ Call Forwarding Override <sup>1</sup>                                | <a href="#">5-123</a> |
|                                   | ■ Coverage of Calls Redirected Off-Net Enabled <sup>2</sup>            |                       |
|                                   | ■ Coverage Subsequent Redirection/CFWD No answer Interval <sup>3</sup> |                       |
| Feature Access Code (FAC)         | ■ Call Forwarding Activation Busy/DA and All Activation                | <a href="#">5-113</a> |
|                                   | ■ Call Forwarding Busy/DA and All Deactivation                         |                       |

*Continued on next page*



**Required forms — Continued**

| Form             | Field  | Page                 |
|------------------|--|----------------------|
| Class of Service | ■ Call Fwd-All Calls <sup>4</sup>                            | <a href="#">5-81</a> |
|                  | ■ Call Forward Busy/DA <sup>3</sup>                          |                      |
|                  | ■ Restrict Call Fwd-Off-Net <sup>2</sup>                     |                      |
| Station          | ■ COS <sup>4</sup>   | <a href="#">6-14</a> |
|                  | ■ Redirection Notification                                   |                      |
|                  | ■ Button/Feature Button Assignments (call-fwd)               |                      |
|                  | ■ Button/Feature Button Assignment (cfwd-bsyda) <sup>3</sup> |                      |

- 
1. Call Forwarding Override only
  2. Call Forwarding Off Net only
  3. Call Forwarding Busy/Don't Answer only
  4. Call Forwarding All Calls only
- 

**Detailed description**

You assign Call Forwarding All Calls and Call Forwarding Busy/Don't Answer to extensions on a Class of Service basis. You assign Call Forwarding Override and Call Forwarding Off-Net on a system-wide basis. You can also restrict Call Forwarding Off-Net with the Class of Service.

**Call Forwarding All Calls**

Voice-terminal users and data-terminal users can activate or deactivate Call Forwarding All Calls for their own terminals with a feature-access code or Call Forward-All feature button. An attendant or voice-terminal user with console permission can activate or deactivate the feature for another extension, TEG, DDC, UCD group, or ACD split (but not vector-controlled splits).

**Call Forwarding Busy/Don't Answer**

The feature is activated or deactivated with a feature-access code or Call Forward Busy/Don't Answer feature button. An attendant or voice terminal with console permission can also activate or deactivate the feature for another extension by using a feature-access code.

Call Forward Busy/Don't Answer cannot be activated for hunt groups, data extensions, or terminating extension groups (TEG). Calls to an attendant or EAS agent cannot be forwarded.

## Call Forwarding Off Net

If Coverage of Calls Redirected Off-Net on the System Parameters Customer-Options form and Coverage of Calls Redirected Off-Net Enabled on the Feature-Related System Parameters form are both set to **y**, the system allows calls forwarded off-net to be monitored for busy or no-answer conditions. The system may bring the call back for call-coverage processing if the principal's coverage criteria are satisfied at the forwarded-to destination. However, if the principal does not have a coverage path, the system does not monitor the call. It is left at the off-net destination regardless of whether it is answered or busy.

If the principal has Send All Calls active, the system does not attempt Call Forwarding Off-Net, except for priority calls. Likewise, the system does not attempt Call Forwarding Off-Net for coverage paths that specify Cover All, except for priority calls.



### NOTE:

Using Call Forwarding Off Net outside the US requires the OCM call classification form.

## Call Forwarding — Override

You can administer Call Forwarding Override on a system-wide basis to allow a forwarded-to party to override Call Forwarding when placing a call to the forwarded-from party. Call Forwarding Override is invoked automatically if the system-wide override option is set.

Call Forwarding Override cannot be used when calls forward to an external number. Call Forwarding All Calls from a data user or a hunt group cannot be overridden with Call Forwarding Override.

## End-user procedures

Voice terminal users activate Call Forwarding All Calls and Call Forward Busy/Don't Answer either by dialing a feature-access code or pressing a feature button and then dialing the forwarded-to destination number. They must press either the Call Forwarding All Calls button or the Call Forward Busy/Don't Answer button, as appropriate. They can deactivate the feature by dialing the appropriate feature-access code or by pressing the feature button again.

Voice-terminal users with console permission and attendants can activate Call Forwarding All Calls for another user by dialing a feature access code, followed by the forwarding-from extension and then the forwarded-to extension. They

deactivate the feature by dialing the appropriate feature access code, followed by the extension for which the feature is to be canceled.

## Security

---

Use the **list call-forwarding** command to identify unauthorized Call Forwarding feature activation. The list shows the station name, station number, and forwarded-to destination number.



### SECURITY ALERT:

*Users who do not have permission to call out of the building may not do so with Call Forwarding.*

## Considerations

---

Calls can be forwarded only once. Consider the following scenario. Extension A forwards its calls to extension B. Extension B forwards its calls to extension C. Calls made to extension A:

- Ring at A, if possible
- Ring at B, if possible
- Redirect to extension A's coverage path, if available and A's coverage criteria are satisfied when applied to B
- Return busy tone to the calling party
- Are not forwarded to extension C

There is no maximum number of calls that can be forwarded simultaneously.

You can administer a terminal to receive a redirection notification signal when a call is forwarded.

The system restricts users from forwarding calls to a number that they are not allowed to call.

If **save translation** is run after call forwarding is activated for a terminal, forwarding is saved to tape.

## Attendant

The attendant cannot have a Call Forwarding button.

Only the attendant or voice-terminal user with console permission can activate Call Forwarding All Calls for TEG, UCD groups, and DDC.

Calls to attendants cannot be forwarded. However, calls can be forwarded to the attendant *group*.

Only the attendant, or a station with console permissions, can activate Call Forwarding All Calls for a data module.

## Off net

If call on an incoming trunk is forwarded to an off-net number, any other calls on and incoming trunk to the same extension within the next 30 seconds receive busy tone or redirect to coverage if Send All Calls is assigned. This prevents the first call from forwarding back from a remote device and then being forwarded again, thus ultimately using all available trunks.

When a call is forwarded off net, the forwarded-to number can have up to 16 digits. When counting the 16-digit limit, count the TAC or ARS feature access code (usually a "9"). Do not count the "#" used to terminate a forwarded-to number.

Calls forwarding off net require an available outgoing trunk. Additionally, when Coverage of Calls Redirected Off-Net is enabled, a call-classifier port must be available. If there are no call-classifier ports available, the call still routes off net, but it is not monitored for call progress tones and cannot be returned to the switch for further call coverage processing.

In some instances more than one call classifier may be monitoring an off net (coverage/forwarding) call. If the call is answered and for some reason one of the call classifiers fails to detect the answer, the call may be disconnected and redirected to further coverage treatment.

The list measurement tone-receiver traffic reports provide port usage for this feature.

## Interactions

---

- Answer Detection

This feature shares call-classifier resources with the Coverage of Calls Redirected Off-Net feature.

- Attendant Override of Diversion Features

If an attendant uses redirection override to call a user who has Call Forwarding active, the call does not forward and remains at the user's voice terminal.

- Automatic Callback and Ringback Queuing

Automatic Callback cannot be activated toward a voice terminal that has Call Forwarding active. If Automatic Callback was activated first, the callback call attempt is redirected to the forwarded-to party.

- Bridging

Calls do not terminate to bridged appearances when Call Forward Busy/Don't Answer is active.

The switch blocks users from bridging onto a call that has routed off net while the call is undergoing call classification.

- Call Coverage

If the principal's (forwarding extension) redirection criteria are met at the designated (forwarded-to) destination, the forwarded call redirects to the principal's coverage path; the designated destination gets a temporary bridged appearance (except when it is off net), which remains active after the call is answered so that the designated extension can bridge onto the call if desired. The temporary bridge appearance remains until the caller hangs up.

If Cover All Calls is part of the coverage redirection criteria and if Call Forwarding or Call Forwarding Off-Net is active at a voice terminal, incoming priority calls forward to the designated destination; all other calls redirect according to the Call Coverage path. Non-priority calls are not directed off net.

When a covering user has activated Call Forwarding, a coverage redirected call does not forward to the designated extension number. Instead, the call is redirected to the next point in the principal's coverage path, if available. If no other coverage point is available, the call remains at the principal's voice terminal.

- Call Detail Recording

When a call is forwarded to an off-net number, the call is recorded in CDR records as a call from the forwarding station. When *Coverage of Calls Redirected Off-Net* is enabled, a CDR record is generated only after the call has actually been answered off net.

If forced entry of account codes is required, calls cannot be forwarded to off-net destinations.

- Call Forwarding All Calls and Call Forward Busy/Don't Answer

Call Forwarding All Calls and Call Forward Busy/Don't Answer cannot be active for the same terminal at the same time.

- Call Park

Calls can be parked on a forwarded-from extension even though Call Forwarding is active for that extension. If a forwarded-to extension user parks a call that had been forwarded to that extension, the call is normally parked on the forwarded-to extension, not the forwarded-from extension.

- Call Pickup/Directed Call Pickup

If the *Temporary Bridged Appearance* on *Call Pickup* field is set to **y** on the *Feature-Related System Parameters* form, a *Temporary Bridged Appearance* is maintained if the forwarded-to destination is a

member of the same call pickup group as that of the forwarded from station. If the Temporary Bridged Appearance on Call Pickup field is set to n, a Temporary Bridged Appearance is not maintained.

- Call Prompting

This feature shares call-classifier resources with the Coverage of Calls Redirected Off-Net feature.

- Call Visor ASAI

This feature shares call-classifier resources with the Coverage of Calls Redirected Off-Net feature.

- Conference

The switch blocks users from conferencing another party onto a call which has routed off net while the call is undergoing call classification. If any party on a call that has forwarded off net is on hold (due to the initiation of a conference), the call routes off net without undergoing call classification. This occurs even when Coverage of Calls Redirected Off-Net is enabled.

- Direct Inward Dialing

If an incoming DID call is forwarded to an external (off-net) number, any other incoming DID calls to the same DID extension within the next 30 seconds receive busy tone or redirect to coverage, if assigned.

- Expert Agent Selection

Agents logged in with EAS enabled cannot activate or deactivate Call Forwarding. The physical extension where the EAS agent is logged in can be forwarded, but the EAS agent must first log out. Then, the phone can be forwarded.

- Hold

If any party is on hold when a forwarded-to call routes off net, that call does not undergo call classification, even when Coverage of Calls Redirected Off-Net is enabled.

- Hot Line Service and Manual Originating Line Service

Voice terminals assigned these features cannot activate Call Forwarding. However, calls can be forwarded to these terminals. Other users can activate Call Forwarding for the hotline terminal.

- Interflow

The Interflow feature allows ACD calls to be redirected from one split to a split on another switch or to another external location. This is accomplished by forwarding calls that are directed to the split extension to an off-notify-net location via the Call Forwarding All Calls feature.

- Intraflow

Call forwarding can be used to unconditionally redirect ACD calls from a split to another destination on the same switch.

- Leave Word Calling

LWC cannot be activated toward a voice terminal that has Call Forwarding activated. If LWC was activated before the called voice-terminal user activated Call Forwarding, the callback call attempt is redirected to the forwarded-to party.

- MFC Signaling

This feature shares call classification resources with the *Coverage of Calls Redirected Off-Net* feature.

- Personal Central Office Line

PCOL calls cannot be forwarded.

- QSIG

If a call is forwarded over an ISDN-PRI trunk administered with supplementary service protocol "b" (QSIG), then additional call information may be displayed. See ["QSIG" on page 12-77](#) for more information.

- Send All Calls

If an extension has both Send All Calls and Call Forwarding All Calls activated, calls to that extension that can immediately be redirected to coverage are redirected. However, other calls, such as Priority Calls, are forwarded to the designated extension.

Activation of Send All Calls at the forwarded-to extension does not affect calls forwarded to that extension.

- Temporary Bridged Appearance

The system maintains a Temporary Bridged Appearance for on-net calls after the call is answered or until the caller hangs up. However, for calls forwarded off-net, the system cannot maintain a Temporary Bridged Appearance. Once the call is redirected to the principal's coverage path, the trunk to the off-net, forwarded-to, number is released.

- Transfer

The switch blocks a user from transferring a call which has routed off net to another party while the call is undergoing call classification. If any party on a call that has routed off net is on hold (due to the initiation of a transfer), the call routes off net without undergoing call classification. This occurs even when *Coverage of Calls Redirected Off-Net* is enabled.

## Call Park

---

Call Park allows users to put a call on hold and then retrieve the call from any other voice terminal within the system.

### How to administer Call Park

---

#### Required forms

---

| Form                              | Field   | Page                  |
|-----------------------------------|---|-----------------------|
| Feature Access Code (FAC)         | ■ Call Park Access Code                             | <a href="#">5-113</a> |
|                                   | ■ Answer Back Access Code                           |                       |
| Feature-Related System Parameters | ■ Call Park Timeout Interval (minutes)              | <a href="#">5-123</a> |
|                                   | ■ Deluxe Paging and Call Park Timeout to Originator |                       |
| Station (multiappearance)         | ■ Button Assignments<br>— call-park                 | <a href="#">6-14</a>  |
| Console-Parameters                | ■ Common Shared Extensions<br>— all fields          | <a href="#">5-86</a>  |

### Detailed description

---

You can set a system-wide expiration interval for parked calls. If a call is not answered within the interval, the parked call redirects to an attendant or to the user who activated Call Park (the parking user). Calls redirect to the attendant if the default “Loudspeaker Paging” option is assigned and to the parking user if the *Deluxe Paging and Call Park Timeout to Originator* option is assigned.

If no attendant or night service extension is administered, and if *Night Service — Trunk Answer from Any Station* is not administered, the expiration interval is ignored and the call remains parked.

If two parties are connected on a parked call, a third party can also answer the call before the interval expires, creating a 3-way conference.

The attendant console group can have common, shared extensions used exclusively for Call Park. These extensions are not assigned to a voice terminal, but are stored in system translations and used to park a call. The extensions are particularly useful when one party is paged at the request of another party. The caller is parked on a common shared extension and the extension is announced. The status lamp associated with the extension identifies “call parked” or “no call parked” (instead of active or idle status).



Call Park allows voice-terminal users to answer a call at one extension, but complete the call at another extension. Call Park also allows users to answer a call at any terminal after being paged by a voice-terminal user or an attendant.

## End-user procedures

---

Call Park can be activated by any of the following:

- Single-line voice-terminal user — Flash the switchhook, dial the Call Park access code, and hang up.
- Multiappearance voice-terminal user — Press the Transfer or Conference button, dial the Call Park access code, and press Transfer or Conference again to keep the parking station on the call until they hang up. You can also park the station by simply pressing the Call Park button (if assigned).
- Attendant — Press Start, dial the Call Park access code followed by any extension, and press Release or use the Direct Extension Selection With Busy Lamp Field feature instead of dialing the extension.

Retrieve parked calls by dialing the Answer Back access code and the extension where the call was parked. Or press the same Call Park button used to park the call.

## Considerations

---

- Only one call per extension can be parked at a time, even if the extension has multiple call appearances. However, a conference call with five parties can be parked. The sixth conferee is the retrieving party.
- Calls cannot be parked on a group extension. If a group member places a call in Call Park, the call is parked on the member's extension. Group members can belong to the following:
  - A coverage answer group
  - A DDC group
  - A terminating extension group
  - A UCD group
- If all appearances on a parked station are busy and no attendant or night-service extensions are configured when the call park timeout expires:
  - A parked call is dropped if no coverage path is assigned
  - A parked call is not dropped if a coverage path is assigned.

## Interactions

---

- Abbreviated Dialing

This button allows users to park calls or retrieve parked calls by pressing a button, instead of using the buttons and access codes separately.
- Automatic Wakeup

Automatic Wakeup calls cannot be parked.
- Bridged Call Appearance

If a user, active on a bridged call appearance, activates Call Park, the call is parked on the primary extension associated with the bridged call appearance.
- Call Vectoring

A call cannot be parked on a VDN extension. Also, a call that is undergoing vector processing cannot be parked.
- Code Calling Access

When a paging party dials the Code Calling Access code and the paged user's extension, the paging party is automatically parked on the paged party's extension.
- Common Shared Extensions

When a call that is parked on a common shared extension times out, the call returns to the park originator. These timeouts are treated as if the Deluxe Paging and Call Park Timeout to Originator field of the Feature-Related System-Parameters form is **y**.
- Conference

Conference calls can be parked.
- Data Privacy and Data Restriction

These features are automatically deactivated when a call is parked.
- Drop

If a digital-terminal user parks a call and then pushes the drop button, the call is unparked. If the parked call is from an internal digital-terminal user, pushing the drop button does not drop the call. The parking user must hang up to drop the call.
- Loudspeaker Paging Access

Calls to paging zones cannot be parked.
- Music-on-Hold

If a parked call involves only one party, the parked user hears music-on-hold. The parking user also hears music after first parking the call and hearing confirmation tone.

- Remote Access

A Remote Access caller cannot park a call. However, the Code Calling Access feature, an answering attendant, or a voice-terminal user can park an incoming Remote Access call.

## Call Pickup

---

Call Pickup and Directed Call Pickup allow a voice-terminal user to answer calls that alert at other extension numbers within the user's specified call pickup group. Directed Call Pickup allows voice-terminal users to pick up any call on the DEFINITY ECS system.

### How to administer Call Pickup

---

#### Required forms

| Form                              | Field   | Page                  |
|-----------------------------------|---|-----------------------|
| Feature-Related System Parameters | ■ Call Pickup Alerting                        | <a href="#">5-123</a> |
|                                   | ■ Temporary Bridged Appearance on Call Pickup |                       |
|                                   | ■ Call Pickup on Intercom Calls               |                       |
|                                   | ■ Directed Call Pickup                        |                       |
| Feature Access Code (FAC)         | ■ Call Pickup Access Code                     | <a href="#">5-113</a> |
|                                   | ■ Directed Call Pickup Access Code            |                       |
| Class of Restriction              | ■ Can Be Picked Up by Directed Call Pickup    | <a href="#">5-72</a>  |
|                                   | ■ Can Use Directed Call Pickup                |                       |
| Pickup Group                      | ■ All   | <a href="#">5-256</a> |
| Station (multiappearance)         | ■ Button/Feature Button Assignments call-pkup | <a href="#">6-14</a>  |

### Detailed description

---

#### Call Pickup

Establish a call pickup group so that when one member of a group is away, other members can answer the absent member's calls. A call pickup group usually consists of users who are located in the same area or who have similar functions.

To pick up another user's call, a user goes off-hook and dials the Call Pickup access code or presses a Call Pickup button.

If a user's voice terminal has a Call Pickup button and status lamp, then:

- The status lamp lights steadily when Call Pickup is used.
- If Call Pickup Alerting is activated, members' status lamps flash when a call comes in to any extension in the call pickup group. Group members other than the called party, can answer using Call Pickup. The called party can answer on the ringing call or bridged appearance.



**NOTE:**

Call Pickup Alerting for a voice terminal takes effect only when the Call Pickup status lamp is not lit. If Call Pickup is used to answer a call, the status lamp lights steadily and does not flash if there are additional calls to the call pickup group.

Both Call Pickup and Call Appearance status buttons flash at the called party's terminal.

If calls ring at 2 or more voice terminals in a call pickup group and a group member presses the Call Pickup button, a distribution algorithm determines which call is answered. Thus, all call pickup group members are treated equally. Specifically, when a Call Pickup button is pressed, the system searches the group extension numbers until reaching an extension with a call eligible for Call Pickup. The next time a Call Pickup button is pressed, the system searches from the *next* extension number.

For example, if extension A has 2 calls ringing and extension B has 1 call ringing, and one of extension A's calls is answered with Call Pickup, then extension B's call is answered the next time Call Pickup is used. After extension B's call is answered, a user can answer the second call to extension A.

When multiple calls ring on a voice terminal and a group member activates Call Pickup, the call with the lowest call-appearance number is answered. For example, if calls ring on the second and fourth call-appearance button on a terminal and a user at another terminal activates Call Pickup, the call on the second call-appearance button is answered.

## Directed Call Pickup

Directed Call Pickup functions like Call Pickup, except for the following:

- A user can answer an alerting call at any terminal on the system — the alerting and answering stations need not be members of the same call pickup group.
- You grant users permission to have their calls answered or to answer others' calls with Directed Call Pickup on a per-station basis on the Class of Restriction form.

## Considerations

---

- A voice terminal can be a member of only one call pickup group.
- When a call pickup group member is away from his or her voice terminal and receives a call, other call pickup group members' voice terminals do not ring. Therefore Call Pickup is only useful if either:
  - Call Pickup Alerting is enabled and call pickup group members have voice terminals with Call Pickup buttons and status lamps.
  - Call pickup group members are in close proximity and can hear each other's voice terminals ring.
- Exclusion is not supported for pickup calls.

## Interactions

---

- Abbreviated Dialing

A user can store:

  - The Directed Call Pickup FAC plus a terminal address in an Abbreviated Dial button
  - The Directed Call Pickup FAC. (The user then dials each extension.)
- Administration without Hardware

Call Pickup and Directed Call Pickup do not recognize an AWOH station without a bridged call appearance. However, once the call has gone to coverage, a member of the covering user's call pickup group can answer a call to an AWOH station. This is true for both real stations and busied-out or disconnected stations.

Once a call has gone to coverage, it can also be picked up using Directed Call Pickup.
- Attendant

Attendant can use Directed Call Pickup, but other users cannot use the feature to answer a call alerting at an attendant's terminal.
- Automatic Callback and Ringback Queuing

Neither call pickup group members or Directed Call Pickup users can answer Callback calls.

- Bridged Call Appearance

- If Call Pickup Alerting is activated and a bridged call appearance rings on a call pickup group member's terminal, other group members cannot pick up the call.

For example, if Adrian's voice terminal rings on a call to a bridged extension number that is not in Adrian's call pickup group, the call cannot be picked up.

- If Call Pickup Alerting is not activated and a voice terminal rings on a bridged call appearance, group members can pick up the call.

If Temporary Bridged Appearance on Call Pickup is enabled, a temporary-bridged appearance is maintained at the called terminal. This allows the called party to bridge onto the call after it has been picked up by another call pickup group member.

Directed Call Pickup cannot be used to pick up a call alerting at a bridged call appearance.

- Call Coverage

You can use Directed Call Pickup to answer a redirected call alerting at a covering user's terminal if there is a call-coverage temporary bridged appearance.

- Call Detail Recording

The extension number dialed by the caller is recorded as the dialed number in CDR.

- Call Forwarding

If Temporary Bridged Appearance on Call Pickup is enabled, a temporary bridged appearance is maintained if the forwarded-to station belongs to the same call pickup group as the forwarded-from station. If Temporary Bridged Appearance on Call Pickup is not enabled, a temporary bridged appearance is not maintained.

- Call Pickup Alerting

If a user who is a member of a ringing terminal's pickup group uses the Direct Call Pickup to answer a call and the call is the only call ringing for any member of the pickup group, the Call Pickup Alerting lamp goes dark when the user picks up the call.

If a user who is not a member of a pickup group uses Direct Call Pickup to answer a call, then Call Pickup Alerting does not apply.

- Call Waiting Termination

You cannot use Call Pickup to pick up a Call Waiting call.

- Conference

If Call Pickup Alerting is enabled and a call is picked up and conferenced into a conference call, the Call Pickup status lamp flashes if additional calls are available for Call Pickup.

- Consult

If *Temporary Bridged Appearance on Call Pickup* is not enabled, the consult call from the covering user appears as an idle-call appearance.

- Expert Agent Selection

EAS agents can use *Directed Call Pickup* to pick up a call or have their calls picked up. The agent's COR overrides the COR of the terminal where the agent is logged in.

If both the terminal's COR and the logged-in agent's COR allow *Directed Call Pickup*, the user picking up the call can use either the station's extension or the agent's loginID.

- Hold

If *Temporary Bridged Appearance on Call Pickup* is not enabled and a user puts a call answered with *Directed Call Pickup* on hold, the called party cannot answer the call because a temporary bridged appearance is maintained. If *Temporary Bridged Appearance on Call Pickup* is enabled, then:

- A call picked up and placed on hold at an extension remains on that extension, even if the called party answers the call.
- If *Call Pickup Alerting* is enabled and a call is picked up and placed on hold, the *Call Pickup* status lamp flashes if additional calls are available for *Call Pickup*.

- Hot Line Service and Manual Originating Line Service

Voice terminals assigned these features can be members of a call pickup group and have calls picked up, but they cannot answer calls for other pickup group members.

- Intercom — Automatic/Dial

If *Call Pickup on Intercom Calls* is activated, you can use *Call Pickup* and *Directed Call Pickup* to pick up *Automatic Intercom* calls. If it is not activated, *Automatic Intercom* calls cannot be picked up and the calls are not included in the *call-pickup-alerting-count*.

- Internal Automatic Answer

Internal calls to a terminal in a call pickup group are eligible for IAA. If the called extension in a call pickup group has IAA activated, the call is answered automatically. An extension that has IAA cannot automatically answer calls to other voice terminals in its call pickup group.

IAA-eligible calls to an IAA extension cannot be answered with *Call Pickup* because they are automatically answered at the called station. Any non-IAA-eligible calls, such as external calls that ring the IAA-active station, can be answered by members of that station's call pickup group.

- Malicious Call Trace



You cannot use Directed Call Pickup to pick up an alerting MCT call at the MCT-Controller terminal.

- Multimedia Call Handling

Do not use Call Pickup or Directed Call Pickup with a Multimedia data endpoint. However, calls alerting at the voice-station entity of a multimedia complex can be picked up with Call Pickup or Directed Call Pickup.

- Privacy — Manual Exclusion

In the following case, the called party is not dropped when Privacy — Manual Exclusion is activated.

A call is made to Station A and Station B picks it up using Call Pickup. Station A bridges onto the call by going off-hook on its call appearance. Station B activates Privacy — Manual Exclusion.

- Tenant Partitioning

Directed Call Pickup follows existing Tenant Partitioning. The feature does not function across tenant partitions unless specifically administered to do so.

- Terminating Extension

You cannot use Directed Call Pickup to pick up a call alerting at a TEG extension number.

- Transfer

If `Call Pickup Alerting` is enabled and a call is picked up and transferred, the Call Pickup status lamp flashes if additional calls are available for Call Pickup.

## Call Timer

---

Call Timer allows automatic starting of the local timer of 6400-series voice terminals on an active originating or receiving call. The timer information is displayed on the voice terminal display.

### How to administer Call Timer

---

#### Required forms

---

| Form    | Field   | Page                 |
|---------|---|----------------------|
| Station | ■ Button/Feature Button Assignments<br>— call timer | <a href="#">6-28</a> |

### Detailed description

---

The timer corresponds to the active call and is implemented using messages already defined for the 6400-series voice terminal timer.

When activated, the timer starts at the same time that the Call Detail Recording (CDR) timer starts.

The display stays active for five seconds after a call is ended or dropped.

### Interactions

---

- Conference

Assume that Call Timer is activated for all stations. If station A dials station B, when station B answers, the call timer starts on stations A and B. When station A presses the conference button, the call timer stops on station A and the system selects the second call appearance. When station A dials station C and station C answers, the call timer on station A and C starts at 0. The call timer on station B is not affected. When station A presses the conference button again, the call timer is not affected on any station.

- Hold

Assume that Call Timer is activated for all stations. Station A puts station B on hold. The call timer stops on station A, but continues if Station A returns to the call. The timer continues on station B.

- Transfer

Assume that Call Timer is activated for all stations. If station A dials station B, when station B answers, the call timer starts on stations A and B. When station A presses the transfer button, the call timer stops on station A and the system selects the second call appearance. When station A dials station C and station C answers, the call timer on station A and C starts at

0. The call timer on station B is not affected. When station A presses the transfer button again, the call on station A terminates and the call timer on station A stops.

## Call Waiting Termination

---

Call Waiting Termination notifies a user with a single-line telephone who is active on one call that a second call is waiting. Assign Call Waiting Termination on a per-voice terminal basis.

### How to administer [Call Waiting Termination](#)

---

#### Required forms

---

| Form                              | Field                               | Page                  |
|-----------------------------------|-------------------------------------|-----------------------|
| Station (single-line)             | ■ Call Waiting Indication           | <a href="#">6-28</a>  |
|                                   | ■ Attendant Call Waiting Indication |                       |
| Feature-Related System Parameters | ■ Repetitive Call Waiting Tone      | <a href="#">5-123</a> |
|                                   | ■ Repetitive Call Waiting Interval  |                       |

---

### Detailed description

---

Single-line terminal users can place a call on hold to answer a waiting call. After answering the waiting call, they can return to the held call or toggle back and forth between the two calls. A single-line, voice-terminal user can connect to only one call at a time.

The caller hears special audible ringback tone while the call waits. Other parties on the call do not hear the tone. If Call Waiting is denied, the caller hears busy tone.

Only one call can wait at a time.

Generally, the single-line terminal user hears one quick burst of tone when a call from another voice-terminal user is waiting, 2 quick bursts of tone when an attendant-handled or an outside call is waiting, and 3 quick bursts of tone when a Priority Call is waiting.

#### NOTE:

Special ring tones are not supported over Direct Inward Dialing (DID) facilities.

An internal caller can activate Leave Word Calling (LWC) or Automatic Callback after Call Waiting has been initiated by the system.

A priority call can wait for the voice terminal to become idle even if Call Waiting Termination is not activated. However, an attendant-handled call receives busy tone unless Attendant Call Waiting Indication is set to **y**.

## 4 Basic Features

### Call Waiting Termination

Page 4-245

Calls to a Direct Department Calling (DDC) or Uniform Call Distribution (UCD) group voice terminal cannot wait. However, such calls can enter the group queue (if provided) unless the queue is full.

## Considerations

---

- Call Waiting Termination applies only to busy single-line voice terminals. Calls to multiappearance voice terminals are routed to an idle call appearance and do not wait.
- An analog voice-terminal user must place the active call on soft hold and dial the Answer Hold-Unhold feature access code to answer the waiting call. The soft-held call then becomes a hard-held call.
- If an analog single-line voice terminal has Call Waiting enabled and has initiated a conference call, Call Waiting is denied. For example, caller A (on an analog terminal) is talking to caller B, then flashes and is talking to caller C, and then flashes to conference B and C. Then, if caller D attempts to call caller A, Call Wait is denied.

## Interactions

---

Call Waiting is denied when the following features are activated at the single-line voice terminal:

- Another Call Waiting Call
- Automatic Callback (to or from the voice terminal)
- Data Privacy
- Data Restriction

A Call Waiting call cannot be picked up by a Call Pickup group member or by directed call pick-up.

## Calling Party/Billing Number

---

Calling Party Number/Billing Number (CPN/BN) allows the system to transmit CPN/BN information to an ISDN-PRI trunk group. The CPN is the calling party's telephone number. BN is the calling party's billing number. The CPN/BN may contain international country codes.

CPN/BN is used with an adjunct application. See [“Inbound Call Management” on page 9-81](#) for more information on using CPN/BN with an adjunct. See [“Multifrequency-Signaling-Related System Parameters” on page 5-228](#), [“Integrated Services Digital Network — Basic Rate Interface Endpoints” on page 4-382](#) for more information.

### How to administer CPN/BN

---

#### Required forms

| Form                                | Field                                  | Page   |
|-------------------------------------|--|--|
| Trunk Group (ISDN-PRI)              | ■ All fields including Per Call CPN/BN | <a href="#">7-219</a>                                |
| ISDN Numbering —<br>Public/ Unknown | ■ All                                  | <a href="#">7-95</a>                                 |
| or                                  |  |  |
| ISDN Numbering —<br>Private         |  | <a href="#">7-93</a>                                 |
| Processor Channel<br>Assignment     | ■ All                                  | <a href="#">5-248</a><br>or<br><a href="#">5-252</a> |

On the Trunk Group (ISDN-PRI) form, assign all fields needed to provide an ISDN/PRI between the system and the adjunct. Set the `Per Call CPN/BN` field to **can-only**, **can-pref**, **bn-only**, or **bn-pref** as required to ensure that CPN/BN information is sent with a call-offered event report to the adjunct.

On the Processor Channel Form, assign all fields for one data link. The system can support only one interface.

All ISDN-PRI- and ACD-related forms must be administered as described in the [“ISDN Numbering — Private” on page 7-93](#) and [“Automatic Call Distribution” on page 9-25](#) sections in this book.

### Interactions

---

None.

## Calling Party Number Restriction

The Calling Party Number (CPN) Restriction feature provides the Per Call and Per Line CPN Restriction capabilities available to many public network users.

Stations may be administered on a Per Line CPN Restriction basis to specify how CPN primary information is delivered for locally originated calls. Also, this feature provides you with the capability to indicate whether the CPN primary indication is delivered for locally originated calls on a per call basis.

### How to administer CPN Restriction

#### Required forms

| Form                              | Field  | Page                  |
|-----------------------------------|--|-----------------------|
| Feature Access Code (FAC)         | ■ Per Call Calling Party Number (CPN) Blocking         | <a href="#">5-113</a> |
|                                   | ■ Per Call Calling Party Number (CPN) Unblocking       |                       |
| Station form                      | ■ Per Station CPN - Send Calling Number                | <a href="#">6-28</a>  |
| System-Parameters Customer-Option | ■ ISDN-PRI   | <a href="#">5-277</a> |
| Trunk Group                       | For each trunk group, administer the following fields: | <a href="#">7-115</a> |
| — Access                          |  |                       |
| — APLT                            | ■ Per Call CPN Blocking Code                           |                       |
| — CO                              | ■ Per Call CPN Unblocking Code                         |                       |
| — DIOD                            |  |                       |
| — FX                              |  |                       |
| — ISDN-BRI                        |  |                       |
| — ISDN-PRI                        |  |                       |
| — Tandem                          |  |                       |
| — Tie                             |  |                       |
| — WATS                            |  |                       |

- To use with ISDN-PRI, set `ISDN-PRI` field on System Parameters Customer-Options form to **y**.
- To use with ISDN-BRI, set `ISDN-BRI Trunks` field on System Parameters Customer-Options form to **y**.
- CPN Restriction works on any trunk supporting MFC signaling.

## Detailed description

### Per Line CPN Restriction

You may subscribe on a per-station basis where a default parameter is set to govern the privacy indication of the Calling Party Number when it originates calls. For ISDN calls, the CPN Presentation Indicator is encoded accordingly. For non-ISDN calls going to a public network that supports the CPN Restriction feature, the network specific Feature Activation Code passes to the network to interpret and activate the desired feature.

If Per Line CPN Restriction is administered for a station, it overrides any outgoing ISDN Trunk Group administrated for sending Calling Number.

### Per Call CPN Restriction

When this feature is activated with a Feature Access Code (FAC) or feature button, you may indicate whether the CPN indication will be delivered for locally originated calls. For ISDN calls, the CPN Presentation Indicator is encoded accordingly. For non-ISDN calls going to a public network that supports the CPN Restriction feature, the network-specific FAC is passed to the network to interpret and activate the desired feature.

If Per Call CPN Restriction is activated for an outgoing call, it overrides any Per Line CPN Restriction administration for the calling station, and overrides any ISDN Trunk Group administration for sending the Calling Number.

#### NOTE:

In the case of non-ISDN calls, it is the responsibility of PBX providers to provision calling number information associated for each line with the central office (CO).

The Per Line and Per Call features are *not* supported in the following cases:

- Local switch station-to-station calls
- Attendant and data module originated calls
- DCS calls (for instance, DCS Calling Number information is not affected by either Per Call or Per Line CPN Restriction features)
- Uniform Dial Plan (UDP) calls
- Trunk Access Code (TAC) calls where either the Per Line CPN Restriction field is **y** or **r**, or when the Per Call CPN Restriction FAC is dialed before the TAC
- Non-ISDN calls that must be tandemed
- The Per Call CPN Restriction over the Adjunct Switch Application Interface (ASAI) and CTI interfaces.



## CPN Restriction Precedence

DEFINITY ECS applies the following precedence, in descending order, when originating CPN Restriction indication:

- The Per Call CPN Restriction features (Blocking, Unblocking) overrides any Per Line CPN Restriction administration on the originating station, and overrides any administration for “sending calling number” on the Trunk Group that carries the call.
- The Per Line CPN Restriction overrides any administration for “sending calling number” on the Trunk Group that carries the call.
- The existing Trunk Group administration for “sending calling number” applies when neither Per Call nor Per Line CPN Restriction applies to an outgoing call.

DEFINITY ECS applies the following precedence, in descending order, in the tandem situation:

- For a tandemed ISDN call, the current DEFINITY ECS behavior stays unchanged and only the Tandem Trunk Group’s “sending calling number” administration applies.
- For a tandemed non-ISDN call, if received with either the CPN Blocking FAC or CPN Unblocking FAC as the first digits, the tandem node attempts to apply the CPN Blocking or CPN Unblocking feature to the call. It does this by prepending any network FAC for either CPN Blocking or CPN Unblocking administered for the outgoing trunk group to the called digit information.

## **CallVisor Adjunct-Switch Application Interface**

---

CallVisor Adjunct/Switch Applications Interface (ASAI) links DEFINITY ECS and adjunct applications. The interface allows adjunct applications to access switch features and supply routing information to the switch. CallVisor ASAI improves Automatic Call Distribution (ACD) agents' call handling efficiency by allowing an adjunct to monitor, initiate, control, and terminate calls on the switch. The CallVisor ASAI interface may be used for Inbound Call Management (ICM), Outbound Call Management (OCM), and office automation/messaging applications.

CallVisor ASAI is supported by two transport types: Integrated Services Digital Network (ISDN) Basic Rate Interface (BRI) transport (CallVisor ASAI-BRI) and LAN Gateway Transmission Control Protocol/Internet Protocol transport (DEFINITY LAN Gateway).

CallVisor ASAI messages and procedures are based on the ITU-T Q.932 international standard for supplementary services. The Q.932 Facilities Information Element (FIE) carries the CallVisor ASAI requests and responses across the interface. An application program can access CallVisor ASAI services by supporting the ASAI protocol or by using a third-party vendor application programming interface (API).

See [Figure 4-3](#) for a simple ASAI configuration example.

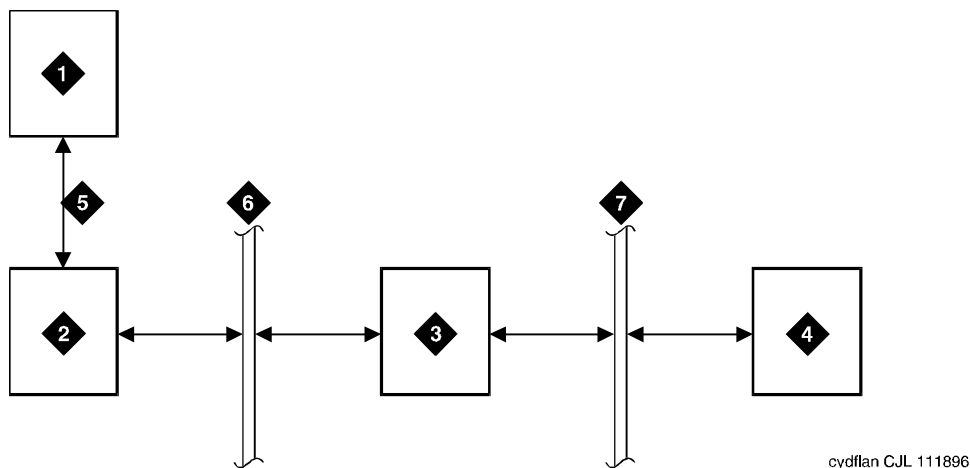

Figure Notes

- |                                       |               |
|---------------------------------------|---------------|
| 1. ASAI adjunct                       | 5. ISDN-BRI   |
| 2. TN556 or TN2198 ISDN-BRI line card | 6. Packet bus |
| 3. TN778 packet controller            | 7. Memory bus |
| 4. Switch processing element(SPE)     |               |

Figure 4-3. ASAI Switch Interface Link — LAN Transport

For detailed information on CallVisor ASAI, see:

- *DEFINITY* Enterprise Communications Server CallVisor ASAI Protocol Reference
- *DEFINITY* Enterprise Communications Server CallVisor ASAI Technical Reference
- *DEFINITY* Enterprise Communications Server Installation, Administration, and Maintenance of CallVisor ASAI Over the *DEFINITY* LAN Gateway

## How to administer ASAI

You must enable `Packet Bus Activated` on the Maintenance-Related System Parameters form before administering other CallVisor ASAI forms.

Administer CallVisor ASAI on the *DEFINITY* ECS.

**Required forms**

| <b>Form</b>                           | <b>Field</b>                                      | <b>Page</b>           |
|---------------------------------------|---|-----------------------|
| System Parameters<br>Customer-Options | ■ ASAI Interface                                  | <a href="#">5-277</a> |
|                                       | ■ ASAI Proprietary Adjunct Links                  |                       |
|                                       | ■ Adjunct Call Control                            |                       |
|                                       | ■ Adjunct Routing                                 |                       |
|                                       | ■ Domain Control                                  |                       |
|                                       | ■ Event Notification                              |                       |
|                                       | ■ Request Feature                                 |                       |
|                                       | ■ Set Value                                       |                       |
|                                       | ■ Answering Machine Detection                     |                       |
|                                       | ■ Selective Listening                             |                       |
|                                       | ■ Switch Classified Outbound Calls                |                       |
| Hunt Group                            | ■ Controlling Adjunct                             | <a href="#">5-158</a> |
|                                       | ■ ASAI Link Extension                             |                       |
| Feature Related<br>System Parameters  | ■ Call Classification After Answer<br>Supervision | <a href="#">5-123</a> |
| Call Vector                           | ■ ASAI Routing                                    | <a href="#">9-207</a> |
| Class of Restriction                  | ■ Direct Agent Calling (optional)                 | <a href="#">5-72</a>  |
| Trunk Group                           | ■ CPN/BN (Send Calling Number)<br>(optional)      | <a href="#">7-115</a> |
|                                       | ■ Receive Answer Supervision                      |                       |
|                                       | ■ Answer Supervision Timeout                      |                       |

*Continued on next page*

**Required forms — Continued**

| Form                                  | Field                            | Page                  |
|---------------------------------------|----------------------------------|-----------------------|
| Station                               | ■ Extension                      | <a href="#">6-4</a>   |
|                                       | ■ Type                           |                       |
|                                       | ■ Port                           |                       |
|                                       | ■ XID                            |                       |
|                                       | ■ Fixed TEI                      |                       |
|                                       | ■ TEI                            |                       |
|                                       | ■ MIM Support                    |                       |
|                                       | ■ CRV Length                     |                       |
|                                       | ■ Event Minimization             |                       |
| SIT Treatment for Call Classification | ■ All (optional)                 | <a href="#">9-212</a> |
| System Parameters<br>Country-Options  | ■ Tone name, frequency and level | <a href="#">5-277</a> |

**Required forms for ASAI Link**

| Form    | Field                | Page                |
|---------|----------------------|---------------------|
| Station | ■ Extension          | <a href="#">6-4</a> |
|         | ■ Type (asai)        |                     |
|         | ■ XID                |                     |
|         | ■ Fixed TEI          |                     |
|         | ■ TEI                |                     |
|         | ■ MIM Support (no)   |                     |
|         | ■ CRV Length         |                     |
|         | ■ Event Minimization |                     |

- Station form — A CallVisor ASAI endpoint must be administered with station type **ASAI** or **ASAI Proprietary Adjunct link**. Depending on the system, you can assign a maximum of 4 to 8 CallVisor ASAI endpoints.

## Detailed description

### ASAI Capabilities

[Table 4-71](#) shows which capabilities are available automatically when CallVisor ASAI is enabled.

**Table 4-71. Automatically Enabled CallVisor ASAI Capabilities**

| Capability                       | Call Control Group | Adjunct Routing Group | Domain Control Group | Event Notif. Group | Request Feature Group | Set Value Group |
|----------------------------------|--------------------|-----------------------|----------------------|--------------------|-----------------------|-----------------|
| Event Reports                    | X                  |                       | X                    | X                  |                       |                 |
| — Agent Login <sup>1</sup>       |                    |                       | X <sup>2</sup>       |                    |                       |                 |
| — Agent Logout                   |                    |                       | X <sup>2</sup>       |                    |                       |                 |
| — Alerting                       | X                  |                       | X                    | X                  |                       |                 |
| — Answered                       | X                  |                       | X                    |                    |                       |                 |
| — Busy/Unavailable               | X                  |                       | X                    | X                  |                       |                 |
| — Call Ended Event (FAC message) |                    |                       |                      | X                  |                       |                 |
| — Call Initiated                 |                    |                       | X                    |                    |                       |                 |
| — Call Offered to Domain         |                    |                       |                      | X                  |                       |                 |
| — Call Originated <sup>1</sup>   |                    |                       | X                    |                    |                       |                 |
| — Call Redirected                |                    |                       | X                    | X                  |                       |                 |
| — Call Conferenced               | X                  |                       | X                    | X                  |                       |                 |
| — Connected                      | X                  |                       | X                    | X                  |                       |                 |
| — Cut-Through                    | X                  |                       | X                    | X                  |                       |                 |
| — Denial/Reorder                 | X                  |                       | X                    | X                  |                       |                 |
| — Disconnect/Drop                | X                  |                       | X                    | X                  |                       |                 |
| — Hold                           | X                  |                       | X                    | X                  |                       |                 |
| — Queued                         | X                  |                       | X                    | X                  |                       |                 |
| — Reconnected                    | X                  |                       | X                    | X                  |                       |                 |
| — Call Transferred               | X                  |                       | X                    | X                  |                       |                 |
| — Trunk Seized                   | X                  |                       | X                    | X                  |                       |                 |

*Continued on next page*

4 Basic Features

CallVisor Adjunct-Switch Application Interface

Table 4-71. Automatically Enabled CallVisor ASAI Capabilities — Continued

| Capability                       | Call Control Group | Adjunct Routing Group | Domain Control Group | Event Notif. Group | Request Feature Group | Set Value Group |
|----------------------------------|--------------------|-----------------------|----------------------|--------------------|-----------------------|-----------------|
| Request Feature                  |                    |                       |                      |                    | X                     |                 |
| Notification Request             |                    |                       |                      | X                  |                       |                 |
| Notification Cancel              |                    |                       |                      | X                  |                       |                 |
| Notification Ended               |                    |                       |                      | X                  |                       |                 |
| Route End                        |                    | X                     |                      |                    |                       |                 |
| Route Request                    |                    | X                     |                      |                    |                       |                 |
| Route Select                     |                    | X                     |                      |                    |                       |                 |
| Set Value                        |                    |                       |                      |                    |                       | X               |
| Stop Call Notification           |                    |                       |                      | X                  |                       |                 |
| Third Party Answer               |                    |                       | X                    |                    |                       |                 |
| Third Party Auto Dial            |                    |                       | X                    |                    |                       |                 |
| Third Party Call Ended           | X                  |                       |                      |                    |                       |                 |
| Third Party Clear Call           | X                  |                       |                      |                    |                       |                 |
| Third Party Domain Control       |                    |                       | X                    |                    |                       |                 |
| Third Party Domain Control Ended |                    |                       | X                    |                    |                       |                 |
| Third Party Make Call            | X                  |                       |                      |                    |                       |                 |
| Third Party Merge                | X                  |                       | X                    |                    |                       |                 |
| Third Party Reconnect            | X                  |                       | X                    |                    |                       |                 |
| Third Party Relinquish Control   | X                  |                       | X                    |                    |                       |                 |
| Third Party Selective Hold       | X                  |                       | X                    |                    |                       |                 |
| Third Party Selective Drop       | X                  |                       | X                    |                    |                       |                 |
| Third Party Redirect Call        | X                  |                       | X                    |                    |                       |                 |
| Third Party Send DTMF Signals    | X                  |                       | X                    |                    |                       |                 |

Continued on next page

Table 4-71. Automatically Enabled CallVisor ASAI Capabilities — *Continued*

| Capability                       | Call Control Group | Adjunct Routing Group | Domain Control Group | Event Notif. Group | Request Feature Group | Set Value Group |
|----------------------------------|--------------------|-----------------------|----------------------|--------------------|-----------------------|-----------------|
| Third Party Take Control         | X                  |                       |                      |                    |                       |                 |
| Third Party Selective Disconnect | X                  |                       |                      |                    |                       |                 |
| Third Party Selective Reconnect  | X                  |                       |                      |                    |                       |                 |

- 
1. Available with Link Version 2 and above.
  2. Login and logout are provided only for domain control of ACD split; all other event reports are provided for domain control of stations.
- 

## Considerations

---

- If your system has an expansion cabinet (with or without duplication), ASAI resources should reside on the system's Processor Cabinet.

## Interactions

---

Unless noted, you can use system features with ASAI.

- **Abbreviated Dialing**  
An agent logged into an adjunct-controlled ACD split cannot use Abbreviated Dialing buttons or feature access codes (FACs). Abbreviated Dialing cannot be used through ASAI.
- **Add/Remove Skills**  
You cannot add or remove skills through ASAI.
- **Announcements**  
Split forced first or second announcements and vector announcements do not generate event reports for the ASAI adjunct. However, nonsplit announcements send event reports to the adjunct.  
  
Extensions assigned to integrated announcements cannot be domain-controlled.



## 4 Basic Features

### *CallVisor Adjunct-Switch Application Interface*

Page 4-257

- Answer Detection

CallVisor ASAI switch-classified calls, Answer Detection, and Answering Machine Detection share the same set of call-classifier ports.

- Attendant and attendant groups

Individual attendants can be parties on adjunct-monitored calls and are handled like voice-terminal users. Do not use attendant group 0 in CallVisor ASAI call control requests. Event reports are not provided for the attendant group.

Trunks seized for switch-classified calls cannot have Attendant Control activated.

- Authorization Codes

These are not supported for switch-classified calls.

- Automatic Call Distribution (ACD)

ACD agents and terminals can be domain-controlled. Vector-controlled or adjunct-controlled splits/skills cannot be monitored via Event Notification.

- Automatic Callback on Busy/Does Not Answer

You cannot activate Automatic Callback on Busy/Does Not Answer over CallVisor ASAI. A callback call appears as an incoming call to the domain controllers for a station.

- Automatic Route Selection (ARS) and Automatic Alternate Routing (AAR)

ASAI adjuncts can access ARS and AAR via Third Party Make Call, Auto\_dial and Route requests.

With ARS/AAR, the system does not inform the adjunct which trunk group was selected for a given call.

- Bridging

Direct agent calls (DACs) to an agent do not alert bridged users of the agent's extension. Monitored or controlled calls delivered to terminals with bridged call appearances send an Alerting Event Report for the principal and for every alerted bridged call appearance. A Connected Event Report is sent every time the principal or a bridged user connects to the call. Unless the complete bridge is dropped from the call, no event reports are provided when the principal or a bridged user disconnects from the call. The switch provides a Drop Event Report when the complete bridge disconnects.

Third-Party Make Calls delivered as non-ACD calls can alert bridging users, with appropriate events sent for each bridging user and principal. However, Third-Party Selective Hold, Third-Party Merge, Third-Party Reconnect, and Third-Party Selective Drop are not permitted on parties in the bridged state.

## 4 Basic Features

### *CallVisor Adjunct-Switch Application Interface*

Page 4-258

#### ■ Call Coverage

- Switch-classified calls to a destination on the system cannot go to coverage and remain alerting on the principal destination, even if coverage criteria are met. Switch-classified calls to the call originator can go to coverage (for the split or the voice terminal) if the coverage criteria are met.
- Direct agent calls placed through ASAI follow the agent's, not the split's, coverage path, like manually-dialed DACs.
- Calls redirected via ASAI Redirect Call Service continue on the coverage path if not answered.

#### ■ Call Forwarding

- Switch-classified calls to destinations with Call Forwarding remain at the destination. Switch-classified calls to originators with Call Forwarding are forwarded.
- You can activate Call Forwarding through ASAI for a physical extension or an Expert Agent Selection (EAS) agent.

#### ■ Call Park

When a call parks at a terminal that uses transfer, the system generates a Call Transferred Event Report. If the call parks using conference, the system generates a Call Conferenced Event Report.

#### ■ Call Pickup

You must use Call Pickup via the ASAI.

#### ■ Call Prompting

- Up to 24 digits collected from the last collect-digit vector command passes to the adjunct in the Call Offered to Domain Event Report and Route capability.
- ASAI switch-classified calls and Call Prompting contend for the same call-classifier ports.
- You can use a version of call prompting that does not require Call Vectoring through ASAI.

#### ■ Call Vectoring

- An adjunct can directly monitor vector directory numbers (VDNs), but not call vectors.
- While a converse step is being processed, you cannot use ASAI Send DTMF.

#### ■ CDR

Calls that the adjunct originates via Third Party Auto Dial or Third Party Make Call are marked with condition code B. Calls originated manually from a domain-controlled station are not marked with condition code B.

## 4 Basic Features

### *CallVisor Adjunct-Switch Application Interface*

Page 4-259

- Class of Restriction
  - Third Party Make Calls use the originator's voice terminal or split COR. The COR associated with the adjunct's link is not used.
  - For switch-classified calls, only the destination's COR is checked.
  - With adjunct routing, the COR of the associated VDN is checked for calling-party restriction.
- Conference/Transfer

When an agent is logged into an adjunct-controlled split, the agent must use his or her data terminal to conference and transfer calls because the voice terminal is locked.
- Coverage
  - Coverage timer. When Redirect Call redirects a call, the coverage timer for the principal is restarted. Redirect Call can be used while the coverage point is alerted.
  - Don't Answer Coverage timer. If an agent receiving a Direct Agent Call has this timer assigned and the call is redirected, the timer is cancelled.
  - Caller Response Interval (CRI). If a call is redirected from the principal via Redirect Call during the CRI, the CRI timer cancels.
  - Redirection Tone. Redirection tone is not given with Redirect Call.
- Data Call Setup

Data calls may not be set up through ASAI, unless they originate from a voice terminal.
- Directed Call Pickup

This feature cannot be activated through ASAI.
- Display Change Advice Information

This feature can be used through ASAI.
- Distributed Communication Systems (DCS)

Before using DCS with ASAI, it is recommended that you consult a Lucent Technologies representative.
- Do Not Disturb

Direct agent and switch-classified calls placed by ASAI are delivered to ACD agents even if this feature is activated.
- Drop Button Operation

You cannot use Drop Button through ASAI.

## 4 Basic Features

### CallVisor Adjunct-Switch Application Interface

Page 4-260

- Expansion Port Network (EPN)

The Expansion Interface (EI) board allows CallVisor ASAs to terminate on an EPN as well as the Primary Port Network (PPN).
- Forced Entry of Account Codes

You cannot make switch-classified calls to trunk groups with Forced Entry of Account Codes. Agents logged into adjunct-controlled splits cannot enter account codes from their voice terminals.
- Hold

Agents logged into an adjunct-controlled split can invoke Hold only via ASAI.
- Hot Line

Do not use a Third-Party Make Call request for a voice terminal that has Hot Line.
- Hunt Groups

Event-notification requests are not allowed for hunt groups (other than ACD splits).
- Interflow

When a call monitored or controlled by an adjunct interflows to another system, the system stops notifying the adjunct of events, except trunk events (for example, Trunk Seized or Drop).
- ISDN

Third Party Auto Dial calls follow ISDN rules for the originator's name and number. The Call Initiated Event Report is not sent for *en-bloc* BRI sets.
- ISDN Facilities
  - An incoming call over an ISDN facility can provide caller and called-party information, as well as other call-related information (UUI, CINFO, II-Digits) that is passed to the adjunct in event reports and Route Request capabilities.
  - An outgoing call over an ISDN facility provides call feedback events from the network (Cut-through, User Busy, Alerting, and/or Connected). A Trunk Seized Event Report is not sent for outgoing calls using ISDN facilities. Cause values for some SIT responses received will be interpreted.
  - Switch-classified calls use a call classifier on ISDN facilities and use both to classify the disposition of the outgoing call, whether or not the call is interworked, unless Call Classification After Answer system option is activated.
- Last Number Dialed

Do not invoke this feature through ASAI. Third-Party Make Call and Auto Dial save the dialed number in system memory.

## 4 Basic Features

### *CallVisor Adjunct-Switch Application Interface*

Page 4-261

- **Leave Word Calling**

The Message Waiting Lamp can be turned on and off through ASAI.
- **Lookahead Interflow**

For the receiving PBX, Lookahead Interflow information element passed in the ISDN message is included in all subsequent call-offered event report and Route capabilities for the call if the information exists. This information element includes ANI information and the originally-called VDN, but does not include digits collected at the original system.
- **MultiMedia Endpoints**

These cannot be monitored or controlled through ASAI.
- **Multiple Split Queuing**

When a call is queued in multiple split or skill hunt groups, a queued event is provided for each split/skill. When the call is removed from queue, the Alerting Event Report provides the split/skill hunt-group extension of the alerting agent.
- **Music on Hold**

These ports cannot be disconnected using `listen_disconnect` — callers still hear Music on Hold. Do use ASAI Send DTMF signals on a call with Music on Hold.
- **Priority Calling**

You can place Third-Party Make Call, Third-Party Auto Dial, and Route Select calls as priority calls. Priority Call Coverage and alerting rules apply.
- **Privacy-Manual Exclusion**

The system does not send event reports to the adjunct when a user activates Privacy-Manual Exclusion and causes other bridged users to be dropped from the call. You cannot use Third-Party Control capabilities (like Third-Party Answer or Third-Party Reconnect) to bridge users that are not allowed to bridge into an existing call as a result of Privacy-Manual Exclusion.
- **QSIG**

QSIG capabilities cannot be activated through ASAI.
- **R2-MFC Signaling**

ANI that is available from an R2-MFC trunk is passed on to ASAI adjuncts.
- **Redirection on No Answer**

When Redirect Call redirects a call from an agent with RONA active, the RONA timer is cancelled.

## 4 Basic Features

### *CallVisor Adjunct-Switch Application Interface*

Page 4-262

- Ringback Queuing

Calls originated via Third-Party Make Call or Third-Party Auto Dial to a trunk supporting Ringback Queuing or routing cannot queue.
- Russian Signaling — Intrusion on Incoming Toll Calls

Do not use this feature with ASAI.
- Send All Calls

You can activate Send All Calls via ASAI Request.
- Service Observing

You cannot initiate Service Observing through ASAI.
- Single-Line Voice Terminals

Through ASAI, you can conference up to 6 parties from a single-line voice terminal.
- Supervisor assistance

If an agent's voice terminal is locked under adjunct control, ASAI must be used to access supervisor assistance.
- Temporary bridged call appearances

These are not maintained after Redirect Call redirects a call.
- Terminating Extension Group (TEG)

A TEG is similar to bridging for purposes of CallVisor ASAI event reporting. All TEG members can be individually domain-controlled.
- Timed ACW/Agent Pause Between Calls

You cannot activate this feature through ASAI.
- Timed reminder

If an attendant makes calls that are monitored and controlled by an adjunct (including calls originated and routed with CallVisor ASAI), calls that are not answered are redirected to the attendant when the timed reminder interval expires.
- Trunk Groups

CallVisor ASAI event reporting with Personal Central Office Line (PCOL) is like bridging. Each PCOL member can be individually domain-controlled. Each member receives events as applicable to the controlled terminal.
- Voice message retrieval

An adjunct can activate the message-waiting indicator using Set Value. The voice terminal displays: "You have adjunct messages."
- Voice Terminal Display

Twenty-seven-character names are made available to ASAI.
- Wait-Answer Supervision Timer (WAST)

**4 Basic Features**

*CallVisor Adjunct-Switch Application Interface*

*Page 4-263*

If Redirect Call redirects an alerting call, the WAST is cancelled.

- World Class BRI

ASAI does not support these sets.

## Class of Restriction

---

Class of Restriction (COR) defines many different classes of call origination and termination privileges. Systems may have only a single COR, a COR with no restrictions, or as many CORs as necessary to effect the desired restrictions. Many different types of CORs can be assigned to many types of facility on the switch. For example, you can use a calling-party COR to prevent callers from accessing the public network.

### How to administer COR

---

#### Required forms

| Form                             | Field                | Page                  |
|----------------------------------|----------------------|-----------------------|
| Class of Restriction             | ■ All                | <a href="#">5-72</a>  |
| Agent LoginID                    | ■ COR                | <a href="#">9-193</a> |
| Access Endpoint                  | ■ COR                | <a href="#">7-72</a>  |
| Announcements/Audio Sources      | ■ COR                | <a href="#">5-26</a>  |
| Attendant Console                | ■ COR                | <a href="#">5-35</a>  |
| Authorization Code — COR Mapping | ■ COR                | <a href="#">5-54</a>  |
| Console-Parameters               | ■ COR                | <a href="#">5-86</a>  |
| Hunt Groups                      | ■ COR                | <a href="#">5-158</a> |
| Loudspeaker Paging               | ■ COR (1–9, All)     | <a href="#">5-209</a> |
| Data Modules                     | ■ COR                | <a href="#">6-226</a> |
| Remote Access                    | ■ COR (Barrier Code) | <a href="#">5-258</a> |
| Station                          | ■ COR                | <a href="#">6-28</a>  |
| Terminating Extension Group      | ■ COR                | <a href="#">5-295</a> |
| Trunk Groups                     | ■ COR                | <a href="#">7-115</a> |
| Vector Directory Number          | ■ COR                | <a href="#">9-214</a> |

### Detailed description

---

You must define a unique COR for each combination of Facility Restriction Levels (FRL), called-party restrictions, calling-party restrictions, miscellaneous restrictions, and CCSA/EPSCS off-network restrictions.



## Called-party and calling-party restrictions

Called-party and calling-party restrictions are the basis for all CORs. When no restrictions are needed, assign a single COR with called-party and calling-party restrictions set to none. This type of COR can be used for unrestricted voice terminals, trunk groups, terminating extension groups, Uniform Call Distribution (UCD) groups, Direct Department Calling (DDC) groups, data modules, attendant groups, and individual attendant extensions.

The called-party restriction is checked only at the called terminal, module, attendant console, zone, or group, even if a call redirects from one voice terminal to another. For example, if a called terminal (with no terminal restrictions) has Call Forwarding active to a restricted terminal, the call still completes.

You can administer the following called-party and calling-party restrictions:

- All-Toll
- Inward
- Manual terminating line
- Origination
- Outward
- Public
- TAC-Toll
- Termination

### Inward restrictions

You can use inward restrictions to permit users at specific voice terminals to receive only internal calls. Inward restrictions prohibit users at assigned voice terminals from receiving public-network, attendant-originated, and attendant-extended calls.

The COR of the originally-called extension is the only one checked unless you administer 3-way COR check on conference and transfer calls. Denied calls are routed to intercept tone, a recorded announcement, or the attendant for Direct Inward Dialing (DID) calls.

### Manual terminating line restrictions

You can use manual terminating line restrictions to allow users at specific voice terminals to receive calls only from an attendant or that were extended by an attendant. Calls can redirect to a manual terminating line-restricted voice terminal. The COR of the originally-called extension is the only one checked.

Local CO, foreign exchange (FX), and Wide Area Telecommunications Service (WATS) calls are routed to the attendant. DID calls are routed to an announcement or the attendant. Voice-terminal calls are routed to intercept treatment.

### Origination restrictions

You can use origination restrictions to prohibit specific voice-terminal users from originating calls. These users can still receive calls.

### Outward restrictions

You can use outward restrictions to prevent specific voice-terminal users from placing calls to the public network. These users can still place calls to other voice-terminal users, to the attendant, and over tie trunks. If necessary, an attendant or an unrestricted voice-terminal user can extend a call to an outside number for an outward-restricted voice-terminal user.

When outward restriction is applied to the `Calling Party Restriction` field on the Class of Restriction form, calls coming into a trunk with that COR will be denied if they make use of the AAR/ARS feature.

### Public restrictions

Public restrictions prohibit specific voice-terminal users from receiving public-network calls. Denied calls are routed to an intercept tone, a recorded announcement, or the attendant. Public restrictions still allow users to receive internal calls from other voice terminals or calls that were extended from the attendant.

### Termination restrictions

You can use termination restrictions to prohibit specific voice-terminal users from receiving any calls. These users can still originate calls. DID or Advanced Private-Line Termination calls route to a recorded announcement or the attendant.

### Fully restricted service restrictions

Fully restricted service restrictions prevent specific stations from accessing public-network calls. Fully-restricted station users cannot use authorization codes to deactivate this feature.

Calls from the public network to a fully-restricted station redirect to intercept treatment or to the attendant. If the call redirects to the attendant, the attendant's display indicates the call was redirected because of fully restricted service (FULL).

There are circumstances where a station with fully restricted service can access or be accessed by the public network. See ["Interactions" on page 4-274](#) for specific details.

## Miscellaneous terminal restrictions

You can use miscellaneous terminal restrictions to prohibit specific voice-terminal users from accessing other specific terminals. Restricted calls are routed to intercept tone.

## Miscellaneous trunk restrictions

You can use miscellaneous trunk restrictions to prohibit specific voice-terminal users from accessing specific trunk groups, such as WATS or CO trunk groups. Any or all trunk groups can be in a miscellaneous-trunk-restriction group. Restricted calls are routed to intercept tone.

## Toll and TAC-Toll restrictions

Toll restrictions prevent specific voice-terminal users from placing public-network calls to certain toll-call numbers. Toll restriction is *not* a COR; you assign Toll restrictions to outgoing trunk groups on the Trunk Group form. You disable TAC-toll restrictions for specific outgoing trunk groups on the Trunk Group form. For toll restriction settings, see “Toll Restricted” on page [7-131](#).

## Considerations

---

- Any number of CORs can have Fully Restricted Service set to **y**. Then, if a user attempts to call the public network, the call routes to intercept treatment.
- Miscellaneous restrictions are checked on initial call termination and on redirection.
- Miscellaneous restriction groups apply on a per-COR basis. However, you can assign the same COR to more than one facility. Facilities with the same COR may be like facilities (such as two voice terminals) or different facilities (such as a voice terminal and a trunk group).
- When a call is directed to a VDN extension, the COR of the caller and the VDN are compared to determine if the caller can access the associated call vector.
- You can enhance system security by assigning a separate COR to incoming and to outgoing trunk groups, then restricting calling between the two groups.
- A COR can be overridden by Class of Service (COS).

## Examples of Class of Restriction

---

The following examples illustrate some of the practical aspects of CORs.

## Example using calling-party and called-party restrictions and miscellaneous restrictions

To illustrate the use of calling-party and called-party restrictions and miscellaneous restrictions, assume that your system installation provides the following:

- Central-office trunks (outgoing)
- WATS
- FX trunks (outgoing)
- Voice terminals
- Data modules
- Terminating extension groups
- Loudspeaker Paging

Suppose you are given the following requirements:

- Only the attendant can access loudspeaker paging.
- Terminating Extension Groups can accept calls only from internal voice terminals.
- There are six classes of voice terminals:
  - Those that are toll restricted
  - Those that cannot call outside to a public network (outward restricted)
  - Those that can receive calls only from an attendant
  - Those that can call anywhere, any time
  - Those that cannot place FX or WATS calls
  - Those that cannot place WATS calls

### Method 1

Assign a COR to each facility or group of facilities. For simplicity, give each a unique COR:

- COR 40 — Local CO trunks
- COR 41 — WATS trunks
- COR 42 — FX trunks
- COR 43 — Attendant group
- COR 44 — Data modules
- COR 45 — Terminating extension groups
- COR 46 — Loudspeaker Paging access zones

4 Basic Features

Class of Restriction

Page 4-269

- COR 47 — Unrestricted voice terminals
- COR 48 — Toll-restricted voice terminals
- COR 49 — Outward-restricted voice terminals
- COR 50 — Voice terminals that can receive calls only from an attendant
- COR 51 — Voice terminals that cannot place FX or WATS calls
- COR 52 — Voice terminals that cannot place WATS calls

Now determine which CORs cannot call which other CORs:

- COR 40 (local CO trunks) — No restrictions
- COR 41 (WATS) — No restrictions as described above
- COR 42 (FX) — No restrictions
- COR 43 (attendant group) — No restrictions
- COR 44 (data modules) — No restrictions were stated
- COR 45 (TEG) — This COR can receive internal voice-terminal-originated calls only. Since no tie trunks are specified, use Inward Restriction to provide the desired restriction. Set Called Party Restriction to **inward**. If dial-repeating tie trunks are provided, Miscellaneous Restrictions could be used to deny trunk access to the group.
- COR 46 (Loudspeaker Paging Access zones) — Since this COR can be accessed only by an attendant, use Manual Terminating Line to provide the restriction. Set Called Party Restriction to **manual**.
- COR 47 (unrestricted voice terminals) — No restrictions
- COR 48 (toll restricted voice terminals) — Set Calling Party Restriction to **tac-toll**.
- COR 49 (outward restricted voice terminals) — Set Calling Party Restriction to **outward**.
- COR 50 (voice terminals that can receive calls only from an attendant) — Set Called Party Restriction to **manual**.
- COR 51 (voice terminals that cannot place WATS or FX calls) — None of the Calling Party Restrictions uniquely prohibit WATS and FX calls, so Miscellaneous Restrictions. Set COR 41 (WATS) and COR 42 (FX) in CALLING PERMISSION to **n**. Set Calling Party Restriction to **none**.
- COR 52 (voice terminals that cannot place WATS calls) — Set the COR 41 (WATS) in CALLING PERMISSION to **n**. Set Calling Party Restriction to **none**.

## Method 2

Alternatively, consider the restrictions to be assigned. This method is probably more difficult to use, but it minimizes the number of CORs established. This method requires 9 CORs to effect the same restrictions as 13 CORs with the previous method.

Assign the following:

- COR 20 — Manual terminating line restriction



**NOTE:**

A new Manual Terminating-Line Restriction for voice terminals was not established. COR 20 can be assigned.

- COR 21 — Inward restriction
- COR 22 — Toll restriction
- COR 23 — Outward restriction
- COR 24 — Unrestricted
- COR 25 — COR for WATS
- COR 26 — COR for FX
- COR 27 — Provides Miscellaneous Restrictions for WATS and FX. Set COR 25 and COR 26 for COR 27 to **n**.
- COR 28 — Provides Miscellaneous Restriction for WATS. Set COR 25 for COR 28 to **n**.

Now assign the appropriate COR to each physical or screening facility:

- Central-office trunks — COR 24 (unrestricted)
- WATS — COR 25 (WATS COR)
- FX — COR 26 (FX COR)
- Attendant group — COR 24 (unrestricted)
- Voice terminals — COR 22 (toll), COR 23 (outward), COR 20 (manual), COR 24 (unrestricted), COR 27 (WATS and FX miscellaneous), or COR 28 (WATS miscellaneous)
- Data modules — COR 24 (unrestricted)
- Terminating Extension Group — COR 21 (inward)
- Loudspeaker Paging trunks — COR 20 (manual)

### Example using Automatic Alternate Routing r Automatic Route Selection (AAR/ARS) FRL for control of call routing

Assume that your system provides ARS and authorization codes. You are asked to establish a group of users who must dial an authorization code to make outside calls.

Complete the following forms:

1. Feature-Related System Parameter Features form
  - a. Set Authorization Codes Enabled to **y**.
  - b. Set Authorization Code Length to **7**.
  - c. Set Authorization Code Cancellation Symbol to **#**.
  - d. Set Attendant Timeout Flag to **n**.

2. Station form

For unrestricted users, set COR to 1. For restricted users who must dial an authorization code to make outside calls, set COR to 49.

3. Authorization Codes form

For restricted users, set replacement COR to 1. Set an authorization code to their 7-digit phone number.

4. Class of Restriction form

Set originating FRLs for restricted and unrestricted users. For users with a COR of 1, set originating FRL to 7. For users with a COR of 49, set originating FRL to 0.

5. AAR/ARS Route Pattern form

For route pattern 1 and trunk group 40 (CO) set FRL to 1, NPA to 201, and Prefix Mark to 1. Assign first-choice, second-choice, and third-choice routes as follows:

| Trunk Grp | FRL | NPA | Prefix Mark | Toll List | Deleted Digits | Inserted Digits |
|-----------|-----|-----|-------------|-----------|----------------|-----------------|
| 40        | 1   | 201 | 1           |           |                |                 |
| 2         | 3   | 201 | 1           |           |                |                 |
| 32        | 3   | 201 | 1           |           |                | 9               |

For this example, trunk group 40 is a CO trunk, trunk group 2 is WATS, and trunk group 32 is a tie trunk to a System 85.

When a caller dials the ARS access code to call out, the FRL of the originating facility is compared with the FRL of the outgoing trunk group. If the FRL of the originating facility is less than the FRL of the trunk group, the restricted user is prompted (via recall dial tone) to enter an authorization code. After the

authorization code is entered, the call is routed to the CO for completion. If the FRL is insufficient to seize any trunk group in the route pattern, the user hears intercept tone.

Restricted callers are prompted for an authorization code. Unrestricted users simply dial the ARS code followed by the desired number.

## Examples using Miscellaneous Restrictions

Assume that your system installation provides the following:

- Central-office trunks
- WATS
- FX trunks
- Data modules
- Attendant service
- Voice terminals
- DID trunks
- Remote Access

In an unrestricted environment, each these could have the same COR. However, suppose the following requirements exist:

- Attendants cannot make data calls.
- Remote Access can be used only for data calls.
- DID cannot be used for data calls except through Remote Access.

(A dedicated Remote Access trunk group is not required, although one or more could be provided. This example assumes that all Remote Access is via DID.)

- There are three classes of voice terminals:
  - Those that can call anywhere, any time
  - Those that can place local CO and in-house calls only
  - Those that can place local CO, FX, and in-house calls only

Assign a COR to each facility or group of facilities. For simplicity, give each a unique COR:

- COR 30 — Local CO trunks
- COR 31 — WATS trunks
- COR 32 — FX trunks
- COR 33 — Data modules
- COR 34 — Attendant group



## 4 Basic Features

### Class of Restriction

Page 4-273

- COR 35 — Unrestricted voice terminals
- COR 36 — Voice terminals that can place in-house and local CO calls only (no FX or WATS calls)
- COR 37 — Voice terminals that can place in-house, local CO, and FX calls only (no WATS calls)
- COR 38 — DID trunk group
- COR 39 — One of the remote-access barrier codes (can be up to 10)

Now determine which CORs cannot call which other CORs:

- COR 30 (local CO trunks) — No restrictions
- COR 31 (WATS) — CORs that cannot use WATS are specified as they are encountered. WATS itself is an outgoing service without any calling capabilities. Thus, Miscellaneous Restrictions are not specified on this form. Set `Calling Party Restriction` to **none** (although this restriction has no meaning for an outgoing facility). Similarly, the `Called Party Restriction` applies to facilities capable of answering a call. Since this is not the case with WATS, set `Calling Party Restriction` to **none**.
- COR 32 (FX) — No restrictions for reasons cited above for WATS.
- COR 33 (data modules) — No restrictions for reasons cited above for WATS.
- COR 34 (attendant group) — The attendant group cannot call COR 33 (data modules). Set the `COR 33` in `CALLING PERMISSION` to **n**.
- COR 35 (unrestricted voice terminals) — No restrictions
- COR 36 (no FX or WATS calls) — This COR cannot call COR 32 (FX) or COR 31 (WATS). For CORs 32 and 31, set `CALLING PERMISSION` to **n**.
- COR 37 (no WATS calls) — This COR cannot call COR 31 (WATS). For COR 31, set `CALLING PERMISSION` to **n**.
- COR 38 (DID) — This COR cannot call COR 33 (data modules). For COR 33, set `CALLING PERMISSION` to **n**.
- COR 39 (Remote Access barrier code) — This COR can be used for data calls only. Thus, this COR can call COR 33, but not CORs 30 (local CO), 31 (WATS), 32 (FX), 34 (attendant group), 35, 36, or 37 (voice terminals). For CORs 30, 31, 32, 34, 35, 36, and 37, set `CALLING PERMISSION` to **n**. (The CORs listed in the `CALLING PERMISSION` field can be viewed as terminating or screening CORs that can or cannot be called by the originating COR.) Since COR 38 [DID] is neither a terminating nor a screening COR, you do not need to consider it when you assign the barrier-code COR.

## Interactions

---

- **AAR/ARS**

Originating FRLs are assigned via a COR. Termination and Miscellaneous Restrictions do not apply to ARS/AAR calls.
- **AAR/ARS Partitioning**

Partition Group Numbers are assigned via a COR.
- **Bridged Call Appearance**

The COR assigned to a voice terminal's primary extension also applies to calls originated from a bridged call appearance of that extension on another terminal.
- **Call Coverage**

Users who normally are restricted from calls can still receive calls directed to them via Call Coverage. When a call goes to coverage, the called party's (not the covering party's) restrictions are used.
- **Call Forwarding All Calls**

If a call is restricted between the forwarding and forwarded-to extensions, Call Forwarding is denied. Restrictions are always checked when Call Forwarding is activated, but not when a call is forwarded.
- **Controlled Restriction**

Restrictions assigned via Controlled Restriction override COR restriction.
- **Emergency Access to Attendant**

Emergency Access to Attendant calls are not restricted by COR.
- **Forced Entry of Account Code**

This feature is assigned via a COR.
- **Loudspeaker Paging**

The station number represents a loudspeaker paging zone. Each Loudspeaker Paging Access zone and each Code Calling Access zone is assigned a COR.
- **Private Network Access**

Access to the public network via a private network is allowed or denied via a COR (assuming that the private network provides the capability to access the public network).

### Interactions for called-party and calling-party restrictions

- **Controlled Restriction**

Controlled Restrictions are checked when the system authorizes a call.

## 4 Basic Features

### *Class of Restriction*

Page 4-275

- Night Service

Night Station Service overrides Inward, Manual Terminating Line, and Public Restrictions.

Night Station — Trunk Answer From Any Station overrides Inward, Manual Terminating Line and Public Restrictions.

- Tie-Trunk Access

Incoming dial-repeating tie-trunk calls can be completed directly to an inward-restricted or public-restricted extension but cannot be extended by an attendant to an inward-restricted voice terminal.

- Transfer

Incoming trunk calls cannot be transferred to an inward-restricted extension when a 3-way COR check is made.

Incoming trunk calls can be transferred from an unrestricted extension to an inward-restricted or public-restricted extension if the 3-way COR check on Conference is overridden.

### **Interactions for fully restricted service restrictions**

- Centralized Attendant Service

Since COR information is not passed over Release Link Trunks (RLT), fully restricted service allows all CAS calls. Therefore, CAS allows a public network call to complete to a fully-restricted station.

- Distributed Communication System

Fully Restricted Service allows all DCS calls because COR information is not transparent for DCS. DCS can allow a public network call to be completed to a Fully Restricted station.

- Emergency Transfer

All authorization features are bypassed when an Emergency Transfer station is connected to an Emergency Transfer trunk in the Emergency Transfer Mode.

- Hunt Group

Stations with Fully Restricted Service should not be assigned to Hunt Groups without Fully Restricted Service.

The COR assigned to the Hunt Group is checked on calls redirected by the DDC or UCD of the hunt group. Extensions in the hunt group that have Fully Restricted Service can receive calls from the public network (via the hunt group) if the COR of the Hunt Group does not have Fully Restricted Service.

- Personal Central Office Line

Stations with Fully Restricted Service should not be assigned PCOL.

- Remote Access

If a barrier code is entered during connection to remote access, the code's associated COR is used for authorization checks. If remote access does not require a barrier code, then the default barrier code's COR is used. Remote Access can require an authorization code instead of or in addition to the barrier code. If an authorization code is required, the authorization code's associated COR overrides the barrier code's COR.

Fully restricted service should not be assigned to a station with the following features or conditions:

- Abbreviated Dialing
- Bridged Call Appearance
- Attendant stations
- Night Service stations
- Stations that are Call Coverage or Send All Calls points
- Stations that are Call Forward destinations
- Stations that are Call Pickup points

### **Interactions for miscellaneous terminal and trunk restrictions**

- AAR/ARS

AAR and ARS access to a trunk group override miscellaneous trunk restrictions.

- Abbreviated Dialing Privileged Group Number List

A voice-terminal user with authorization to access an Abbreviated Dialing Privileged Group Number List can place calls to any number on that list. COR assignments are not checked.

- Privileged System Number List

A voice-terminal user with authorization to access a Privileged System Number List can place calls to any number on that list. COR assignments are not checked.

## Class of Service

---

Class of Service (COS) determines whether or not voice-terminal users can access the following features and functions.

- Features
  - Automatic Callback
  - Call Forwarding
  - Data Privacy
  - Priority Calling
  - Restrict Call Forwarding Off-Net
  - Call Forward Busy/Don't Answer
  - Personal Station Access
  - Extended Forwarding All
  - Extended Forwarding Busy/Don't Answer
  - Trunk-to-Trunk Transfer Restriction Override
- Functions
  - Console permission
  - Off-hook alert
  - Client room

## How to administer COS

---

### Required forms

---

| Form                 | Field              | Page                  |
|----------------------|--------------------|-----------------------|
| Class of Service     | All                | <a href="#">5-81</a>  |
| Attendant Console    | COS                | <a href="#">5-35</a>  |
| Console-Parameters   | COS                | <a href="#">5-86</a>  |
| Data Modules         | COS                | <a href="#">6-226</a> |
| Station              | COS                | <a href="#">6-28</a>  |
| Remote Access        | COS (Barrier Code) | <a href="#">5-258</a> |
| Packet Gateway Board | COS                | <a href="#">5-246</a> |

### Detailed description

---

Restriction groups and call origination/reception privileges are defined and assigned by a COR, not a COS.

There are 16 possible COS. Administer each desired allowed/denied combination of features and functions to a COS, and indicate that COS number when administering voice terminals.

### Console Permission

Console Permission allows multiappearance voice-terminal users to control the same features that the attendant controls. Console permission is usually provided to front-desk personnel in a hotel or motel. With console permission, you can:

- Activate Automatic Wakeup for another extension
- Activate and deactivate controlled restrictions for another extension or group of extensions
- Activate and deactivate Do Not Disturb for another extension or group of extensions
- Activate Call Forwarding for another extension
- Add and remove agent skills

### Off-Hook Alert

You can administer Off-Hook Alert only if Emergency Access to the Attendant is provided. Off-Hook Alert allows you to administer yes or no to each of the 16 COS parameters.

## **Client Room**

You can administer Client Room only when Hospitality Services are provided and you have a Property Management system interface. Client Room allows users to access Check-In, Check-Out, Room Change/Swap, and Maid status. In addition, Client Room is required at consoles or terminals that are to receive message-waiting notification.

## **Interactions**

---

- **Hunt Groups**

Because hunt groups have an implied COS of 1, be cautious when you assign restrictions to COS 1.

## Code Calling Access

---

Code Calling Access allows attendants, voice-terminal users, and tie-trunk users to page with coded chime signals.

### How to administer Code Calling Access

---

#### Required forms

---

| Form               | Field                               | Page                  |
|--------------------|-------------------------------------|-----------------------|
| Loudspeaker Paging | ■ Code Calling Playing Cycles (1–3) | <a href="#">5-209</a> |
|                    | ■ Port                              |                       |
|                    | ■ Code Calling TACs                 |                       |
|                    | ■ Code Calling CORs                 |                       |
| Code Calling IDs   | ■ All                               | <a href="#">5-84</a>  |

### Detailed description

---

A paging party dials the Code Calling Access code and the extension of the person to be paged. The paging party is automatically parked (through Call Park) on the paged party's extension. The system translates the number to a chime code and then plays the code over loudspeakers. The paged party, recognizing the chime code, can answer the call from any system voice terminal by dialing the Call Park Answer Back access code and his or her own extension.

You can provide up to 9 individual paging zones, such as conference rooms and warehouses. In addition, one zone can activate all zones simultaneously. Each paging zone requires a separate Code Calling Access code.

### Considerations

---

- With Code Calling Access, users do not have to be at their own voice terminal to answer calls. Users who are frequently away from their voice terminal or at a location where a ringing voice terminal might be disturbing can be assigned a chime code. Users can answer parked calls from any system voice terminal.
- You can provide as many as 125 3-digit chime codes. Only one extension can be assigned to a chime code. You can administer chime codes to play up to 3 times.



## Interactions

---

- Abbreviated Dialing  
If Abbreviated Dialing is used for Code Calling Access, do not use special characters. Otherwise, the call is denied.
- Call Park  
This feature is automatically provided with Code Calling Access.
- Conference — Attendant  
A call cannot be conferenced while the attendant is accessing paging equipment. The attendant can, however, release the call after paging the called party.
- Conference — Terminal  
A call cannot be conferenced while the attendant is accessing paging equipment.
- Controlled Restriction  
Controlled Restriction prohibits use of Code Calling Access.
- Loudspeaker Paging Access (PagePac Paging)  
It is not possible to use a PagePac paging system for Code Calling Access when multizone paging is desired. The PagePac paging systems expect a 2-digit code to access a particular zone. The system, however, immediately plays the chime code once a connection is established.
- Miscellaneous Trunk Restriction  
Voice terminals and tie trunks with this restriction cannot use Code Calling Access.
- Origination Restriction  
This restriction prohibits use of Code Calling Access.
- Transfer  
A call cannot be transferred while the attendant is accessing paging equipment.

## Conference — Attendant

---

Conference — Attendant allows the attendant to set up a conference call for as many as six conferees, including the attendant.

### How to administer Conference — Attendant

---

#### Required forms

---

| Form                              | Field  | Page                  |
|-----------------------------------|--|-----------------------|
| Feature-Related System-Parameters | ■ Public Network Trunks on Conference Call         | <a href="#">5-123</a> |
|                                   | ■ Conference Parties with Public Network Trunks    |                       |
|                                   | ■ Conference Parties without Public Network Trunks |                       |

---

### Detailed description

---

To set up a conference, the attendant dials the number of a conferee and presses the split key to add each party.

### Considerations

---

- Use this feature whenever an attendant needs to talk with more than one party at the same time, or to establish a conference call for parties outside the system.
- The attendant can set up only one conference call at a time. The attendant can hold a conference call on the console or release from it.
- The attendant cannot handle other calls while setting up a conference call.
- Only the attendant can add another party to the call, once the attendant is one of the conferees, no matter who established the call.

### Interactions

---

- Bridged Call Appearance  
A user can press the Bridged Appearance button and join a conference call if the call never had 6 parties.
- Call Vectoring  
A VDN can be included as a party in a conference call only after vector processing terminates for that call (for example, after a successful route-to command).

- Trunk-to-Trunk Transfer

If Trunk-to-Trunk Transfer is disabled and the attendant releases from a conference call involving only trunk conferees, the trunks disconnect.

When a multifunction station (BRI/Digital/Hybrid) user dials enough digits to route a call, but could route differently by dialing additional digits, the station does not recognize the Conference or Transfer buttons. The user delays dialing for 3-seconds or dials # to indicate the call route based on the digits already dialed. The Conference or Transfer buttons are then recognized and the switch completes the operation.

Attendant conferencing may not operate properly if the CO does not provide answer supervision. In this case, the Answer Supervision Timeout and Outgoing End of Dial fields are set to the same nonzero number, and the Receive Answer Supervision field is set to **n**.

If the CO *does* provide answer supervision, you can set Answer Supervision Timeout to **0** and Receive Answer Supervision to **y**.

## Conference — Terminal

---

Conference — Terminal allows multiappearance voice-terminal users to make 6-party conference calls without attendant assistance. This feature also allows single-line voice-terminal users to make 3-party conference calls without attendant assistance.

### How to administer Conference — Terminal

---

#### Required forms

---

| Form                              | Field  | Page                  |
|-----------------------------------|--|-----------------------|
| Feature-Related System Parameters | ■ Public Network Trunks on Conference Call         | <a href="#">5-123</a> |
|                                   | ■ Conference Parties With Public Network Trunks    |                       |
|                                   | ■ Conference Parties Without Public Network Trunks |                       |
|                                   | ■ Conference Tone                                  |                       |

---

### Considerations

---

- A single-line voice terminal can have up to 6 parties on a conference call, if each conferee adds another conferee. For example, one user can add a party, who then adds a third party, and so on.
- If you do not allow trunk-to-trunk connections and a voice terminal releases from a conference call (where all of the other parties were connected to the conference via trunks), then all parties are disconnected.
- If an analog single-line set has Call Wait active and creates a conference call, Call Wait is rendered inactive as long as the single-line set is on the call. For example, caller A on an analog set talks to caller B, flashes to talk to caller C, and flashes to conference B and C. Then, if caller D calls caller A, Call Wait is denied.

### Interactions

---

- Bridged Call Appearance  
A Bridged Appearance button can be used to make conference calls. A Bridged Appearance can bridge onto a conference call only if there were never 6 parties on the conference.

- Call Vectoring

A call to a VDN can be included as a party in a conference call only after vector processing terminates for that call (for example, after a successful route-to command).

- Class of Restriction

If `Restriction Override` is set to **all**, the COR of the party being added is always checked against the COR of the party controlling the add-on, but the new party's COR is not checked against any other conferee's CORs.

- Trunk-to-Trunk Transfer

When a multifunction station (BRI/Digital/Hybrid) dials sufficient digits to route a call, but could route differently if additional digits were dialed, the station does not recognize the Conference or Transfer buttons. The user must delay dialing for 3 seconds or dial # to indicate that the call can be routed based on the digits already dialed. The Conference or Transfer buttons are then recognized and the switch completes the call.

## Consult

---

Consult allows a covering user, after answering a coverage call, to call the principal (called party) for private consultation.

Activating Consult places the caller on hold and establishes a private connection between the principal and the covering user. The covering user can then add the caller to the conversation, transfer the call to the principal, or return to the caller.

### How to administer Consult

---

#### Required forms

---

| Form                      | Field  | Page                 |
|---------------------------|--|----------------------|
| Station (multiappearance) | ■ Button/Feature Button Assignments<br>— consult | <a href="#">6-28</a> |

---

### Considerations

---

- Using Consult allows a covering user to confer with the principal, and determine whether he or she wishes to speak with the called party.

### Interactions

---

- Bridged Call Appearance  
Bridged Call Appearances of the principal's extension are not alerted on a Consult call to the principal extension.
- Call Coverage  
Consult is used only in conjunction with Call Coverage. See "[Call Coverage](#)" on page 4-146 for details.
- Call Waiting Termination  
A Consult call acts as a priority call and waits at a single-line voice terminal, even if the terminal does not have Call Waiting Termination assigned.
- Temporary Bridged Appearance  
Consult calls use the Temporary Bridged Appearance maintained on the call. At the end of a Consult call, the bridged appearance is no longer maintained.

## Coverage Callback

---

Coverage Callback allows a covering user to leave a message for the principal (the called party) that a call has been received from a certain party.

### How to administer Coverage Callback

---

#### Required forms

---

| Form                      | Field  | Page                 |
|---------------------------|--|----------------------|
| Station (multiappearance) | ■ Button/Feature Button Assignments<br>— cov-cback | <a href="#">6-28</a> |

---

### Interactions

---

- Call Coverage

Coverage Callback is used only in conjunction with Call Coverage.

## Coverage Incoming Call Identification

Coverage Incoming Call Identification (ICI) allows a member of a Coverage Answer Group to identify an incoming call to that group even though the member does not have a display terminal.

When an incoming call is directed to a Coverage Answer Group, the Coverage Answer Group status lamp button lights. A second coverage call takes control of the Coverage ICI lamp. When the call is released it does not return control to the previous call.

The user presses the Incoming Call Identification (in-call-id) button to identify the hunt or coverage answer group associated with the current, incoming call.

### How to administer Coverage ICI

#### Required forms

| <u>Form</u>               | <u>Field</u>   | <u>Page</u>          |
|---------------------------|--|----------------------|
| Station (multiappearance) | ■ Button Assignment<br>— in-call-id (Type: __ Grp: __) | <a href="#">6-28</a> |

### Interactions

- Call Coverage

Coverage ICI is used only in conjunction with Call Coverage.



## Customer-Provided-Equipment Alarm

The Customer-Provided-Equipment (CPE) Alarm is a customer-provided device, such as a lamp or a bell, that indicates an alarm situation. This device lets you know that a system alarm has occurred and that the system has attempted to contact the appropriate service organization about the problem.

DEFINITY ECS activates the CPE Alarm when an event occurs that corresponds to, or is more severe than, the administered alarm level. You can administer the CPE Alarm for only one of the following levels.

- Major Alarm — A vital system hardware component has failed. An alarm of this level may seriously affect overall service.
- Minor Alarm — A hardware component that may affect service on a limited scale has failed.
- Warning Alarm — A problem may exist with a hardware component, but the problem does not affect service.

DEFINITY ECS automatically deactivates the CPE Alarm when the problem that caused the alarm is resolved. If there are multiple problems, the CPE Alarm remains active until all problems at or above the administered alarm-activation level are resolved.

For more information, see *DEFINITY Enterprise Communications Server Installation for Single-Carrier Cabinets* or *DEFINITY Enterprise Communications Server Installation for Multiple-Carrier Cabinets* manuals.

### How to administer CPE Alarm

#### Required forms

| Form                                  | Field                        | Page                  |
|---------------------------------------|------------------------------|-----------------------|
| Maintenance-Related System Parameters | ■ CPE Alarm Activation Level | <a href="#">5-212</a> |

### Interactions

- Power Failure Transfer

The CPE Alarm is always activated during a Power Failure Transfer regardless of the administered alarm-activation level. This is true even if the alarm is not administered at any level.

## Data Call Setup

---

Data Call Setup provides multiple methods to set up a data call:

- Data-terminal (keyboard) dialing
- Voice-terminal dialing
- Hayes AT command dialing
- Permanent-switched connections
- Administered connections
- Automatic-calling unit interface (MPD and HSC)
- Hotline dialing

### How to administer Data Call Setup

---

Assign ADU-type hunt groups that connect to terminal servers on a host computer as no keyboard dialing.

#### Required forms for data-terminal dialing

---

| Form             | Field                      | Page                  |
|------------------|----------------------------|-----------------------|
| Data Module      |                            |                       |
| — PDM/TDM        | ■ All                      | <a href="#">6-243</a> |
| — Data Line      | ■ All                      | <a href="#">6-234</a> |
| — 7500           | ■ All                      | <a href="#">6-252</a> |
| Modem Pool Group | ■ Circuit Pack Assignments | <a href="#">5-223</a> |

Use voice-terminal dialing to connect the data terminal to an analog modem or when a data terminal is not accessible for dialing.

#### Required forms for voice-terminal dialing

---

| Form                          | Field   | Page                  |
|-------------------------------|---|-----------------------|
| Feature Access Codes          | Data Origination Access Code                    | <a href="#">5-113</a> |
| Station<br>(multi-appearance) | Feature Button Assignments<br>— data-ext (Ext:) | <a href="#">6-28</a>  |
| Data Module                   |   |                       |
| — PDM/TDM                     | ■ All   | <a href="#">6-243</a> |
| — Data Line Data<br>Module    | ■ All   | <a href="#">6-234</a> |
| Modem Pool Group              | ■ Circuit Pack Assignments                      | <a href="#">5-223</a> |

Depending on the hardware used, assign ports to the following:

- Data modules
- BCTs/510Ds
- 7400D-series or CALLMASTER digital voice terminals
- 7500D-series voice terminals with ADM
- Analog modems (port is assigned using 2500 voice-terminal form)

### Detailed description

In addition to data-terminal and voice-terminal dialing, the system accepts calls from other devices, such as a modular-processor data modules (MPDM) equipped with an automatic-calling unit (ACU) interface module. Use this device to dial from a host computer.

### Data Call Setup for DCP and ISDN-BRI modules

In addition to the numeral, #, and \* characters found on a touch-tone pad, the following special characters can be dialed.

#### Special characters

| Character              | Use   |
|------------------------|---|
| SPACE, -, (, and)      | improves legibility. The switch ignores these characters during dialing.  |
| + character (wait)     | interrupts or suspends dialing until the user receives dial tone  |
| , (pause)              | inserts a 1.5-second pause  |
| % (mark)               | indicates digits for end-to-end signaling (touch-tone). This is required when the trunk is rotary. It is not required when the trunk is touch-tone. |
| UNDERLINE or BACKSPACE | corrects previously typed characters on the same line   |
| @                      | deletes the entire line and starts over with a new DIAL: prompt   |

Each line of dialing information can contain up to 42 characters (the + and % characters count as two each).

Examples of dialing are:

- DIAL: 3478
- DIAL: 9+(201) 555-1212

- DIAL: 8, 555-2368
- DIAL: 9+555-2368+%9999+123 (remote access)

Alphanumeric dialing allows a data-terminal user to make a data call by entering an alphanumeric name.

Basic-digit dialing is provided through an ADM or 7500B data module. The user can enter digits from 0 to 9, \*, and # from a 7500 series voice-terminal keypad or an EIA-terminal interface.

Call Forwarding All Calls allows incoming data calls to redirect to a user-designated extension. The attendant or a forwarding party activates the feature by dialing a FAC.

Default Dialing allows a data-terminal user to call a preadministered destination by pressing Enter. The user can call other destinations by entering the complete address.

Data Hotline is a security feature. The switch terminates calls to a preadministered hotline. The system discards any address string and routes the call as if the hotline-destination address were entered. This feature does not affect incoming calls. This feature is mutually exclusive with Default Dialing.

An AC is an end-to-end connection between two endpoints that is automatically established whenever the system restarts or when you administer the connection to be active.

After you administer the ADM as one endpoint of a connection, the switch establishes the connection at the scheduled time and maintains it for the specified length of time. After the call is accepted, the data set enters into continuous mode for the specified length of time. If the switch reboots during the connection, the connection reinitiates. If the connection drops, the switch reinitiates the connection.

The system handles all presently defined BRI bearer data-call requests. Some capabilities that are not supported by Lucent terminals are provided by non-Lucent terminals. If the switch does not support a capability, a proper cause value returns to the terminal.

BRI terminals receive a cause or reason code that identifies why a call is being cleared. The BRI data module converts certain cause values to text messages for display. In a passive-bus multipoint configuration, the system supports two BRI endpoints per port, thus doubling the capacity of the BRI circuit pack. When you change the configuration of a BRI from point-to-point to multipoint, the original endpoint does not need to reinitialize. Only endpoints that support SPID initialization can be administered in a multipoint configuration.

The following call-progress messages and their meanings are provided for DCP and ISDN-BRI modules.

**Call-progress messages**

| Message             | Application | Meaning  |
|---------------------|-------------|--|
| DIAL:               | DCP         | Equivalent to dial tone. Enter the desired number or FAC followed by Enter.  |
| CMD                 | BRI         | Equivalent to dial tone. Enter the desired number or FAC followed by Enter.  |
| RINGING             | DCP, BRI    | Equivalent to ringing tone. Called terminal is ringing.  |
| BUSY                | DCP, BRI    | Equivalent to busy tone. Called number is busy or out of service.  |
| ANSWERED            | DCP, BRI    | Call is answered.  |
| ANSWERED - NOT DATA | DCP         | Call is answered and a modem answer tone is not detected.  |
| TRY AGAIN           | DCP, BRI    | Equivalent to reorder tone. System facilities are currently not available.   |
| DENIED              | DCP, BRI    | Equivalent to intercept tone. Call cannot be placed as dialed.   |
| ABANDONED           | DCP, BRI    | Calling user has abandoned the call.   |
| NO TONE             | DCP, BRI    | Tone is not detected.  |
| CHECK OPTIONS       | DCP, BRI    | Data-module options are incompatible.  |
| XX IN QUEUE         | DCP, BRI    | Current position in queue.   |
| PROCESSING          | DCP, BRI    | Out of queue. Facility is available.   |
| TIMEOUT             | DCP, BRI    | Time is exceeded. Call terminates.   |
| FORWARDED           | DCP, BRI    | Equivalent to redirection-notification signal. Called terminal activates Call Forwarding and receives a call, and call is forwarded. |
| INCOMING CALL       | DCP, BRI    | Equivalent to ringing.   |
| INVALID ADDRESS     | DCP         | Entered name is not in alphanumeric-dialing table.   |
| WRONG ADDRESS       | BRI         | Entered name is not in alphanumeric-dialing table.   |

*Continued on next page*

**Call-progress messages — *Continued***

| Message           | Application | Meaning   |
|-------------------|-------------|---|
| PLEASE ANS-       | DCP, BRI    | Originating voice-terminal user transferred call to data module using One-Button Transfer to Data.        |
| TRANSFER          | DCP         | Data Call Return-to-Voice is occurring.   |
| CONFIRMED         | DCP, BRI    | Equivalent to confirmation tone. Feature request is accepted, or call has gone to a local coverage point. |
| OTHER END         | DCP, BRI    | Endpoint has terminated call.   |
| DISCONNECTED      | DCP, BRI    | Call is disconnected.   |
| WAIT              | DCP, BRI    | Normal processing continues.  |
| WAIT, XX IN QUEUE | DCP         | Call is in a local hunt-group queue.  |

**Data Call Setup for DCP modules**

**Data-terminal dialing**

DCP data-terminal dialing allows a user to set up and disconnect data calls directly from a data terminal as follows.

1. At the DIAL: prompt, the user types the data number. The message RINGING displays.
2. If the call is queued, the message WAIT, XX IN QUEUE displays. The queue position XX updates as the call moves up in queue.
3. To originate and disconnect a call, the user presses BREAK. If the terminal does not generate a 2-second continuous break signal, the user can press originate/disconnect on the data module.
4. The user can enter digits at the DIAL: prompt.

**Voice-terminal dialing**

DCP voice-terminal dialing allows voice-terminal users to originate and control data calls from a voice terminal. Use DCP voice-terminal dialing when a data terminal is not available.

Users can set up a call using any unrestricted voice terminal and then transfer the call to a data endpoint.

The primary way to make data calls is with multiappearance voice-terminal data-extension buttons. Assign any administrable feature button as a data-extension button. The data-extension button provides one-touch access to a data module.

The following options, either alone or combined, permit flexibility in making data calls from a voice terminal.

- One-Button Transfer to Data

A user can transfer a call to the associated data module by pressing the data-extension button after the endpoint answers.

- Return-to-Voice

A user can change the connection from data to voice. The user presses the data-extension button associated with the busy data module. If the user hangs up, the call disconnects. Return of a data call to the voice terminal implies that the same data call is continued in the voice mode, or transferred to another data endpoint.

- Data Call Preindication

A user, before dialing a data endpoint, can reserve the associated data module by pressing the data-extension button. This ensures that a conversion resource, if needed, and the data module are reserved for the call. Use of Data Call Preindication before 1-button transfer to data is recommended for data calls that use toll-network facilities. Data Call Preindication is in effect until the associated data-extension button is pressed again for a 1-button transfer; there is no time-out.

## Data Call Setup for ISDN-BRI modules

### Data-terminal dialing

A user can set up and disconnect data calls directly from a data terminal without using a voice terminal as follows:

1. The user presses Enter a few times. If the CMD: prompt does not appear, the user presses Break A + T at the same time, and then presses Enter.
2. At the CMD: prompt, the user types and presses Enter.
3. To disconnect, the user enters ++++. At the CMD: prompt, the user types end and presses Enter.

### Voice-terminal dialing

ISDN-BRI voice-terminal dialing allows ISDN-BRI voice-terminal users to originate a data call. The user presses the data button on the terminal, enters the number on the dial pad, and then presses the data button again.

The following data functions are not available on ISDN-BRI voice terminals:

- One-Button Transfer to Data
- Return-to-Voice
- Data Call Preindication
- Voice-Call Transfer to Data and Data-Call Transfer to Voice

## Considerations

---

- BRI has a voice-to-data restriction. A voice terminal cannot call a data terminal, and a data terminal cannot call a voice terminal.
- BRI voice terminals cannot have data-extension buttons. DCP sets have these buttons, but cannot have data-extension buttons for BRI.
- When a voice-terminal user places a data call with a modem, the user dials the data-origination access code assigned in the system before dialing the endpoint.
- The number of assigned data-extension buttons per voice terminal is not limited. Assign voice-terminal buttons that access the data module.
- Voice-terminal dialing is not available in ISDN-BRI applications because ISDN-BRI terminals do not support voice-call transfer to data or data-call transfer to voice.

## Interactions

---

- Abbreviated Dialing

Only 22 of the 24 (maximum) digits in an abbreviated-dialing number are available for keyboard dialing. The remaining two digits must contain the wait indicator for tone detection.
- Call Coverage

A hunt group made up of data endpoints cannot be assigned a coverage path.
- Call Detail Recording

CDR records the use of modem pools on trunk calls.
- Call Forwarding All Calls

Calls received by a data module can be forwarded. Activate Call Forwarding All Calls with data-terminal (keyboard) dialing. If the forwarded-to endpoint is an analog endpoint and the caller is a digital endpoint, modem pooling is activated automatically.
- Internal Automatic Answer

Data calls are not eligible for IAA.



- Modem Pooling

Modem Pooling is available on data calls. The system automatically inserts a modem if one is needed. Data Call Preindication or Data Origination can be used to indicate the need for a modem.

- UCD

UCD can provide a group of data modules or analog modems for answering calls to connected facilities (for example, computer ports).

- World-Class Tone Detection

Multiple-line data-terminal dialing is supported if the administered level of tone detection is precise. You can administer tone-detection options. The message that Data Call Setup sends to users varies according to the option.

If the option is not set to precise, and a data call is set up over an analog trunk, messages describing the status of the called endpoint (for example, RINGING, BUSY, TRY AGAIN) change according to which tone-detection option is selected.

## Data Hotline

---

Data Hotline provides for automatic-nondial placement of a data call preassigned to an endpoint when the originating switch goes off-hook. Use for security purposes.

### How to administer Data Hotline

---

#### Required forms

---

| Form                | Field                              | Page                  |
|---------------------|------------------------------------|-----------------------|
| Abbreviated Dialing |                                    |                       |
| — Enhanced List     | ■ All                              | <a href="#">5-2</a>   |
| — Group List        | ■ All                              | <a href="#">5-5</a>   |
| — System List       | ■ All                              | <a href="#">5-11</a>  |
| — Personal          | ■ All                              | <a href="#">5-8</a>   |
| — 7103A             | ■ All                              | <a href="#">5-14</a>  |
| Station             |                                    |                       |
|                     | ■ Abbreviated Dialing List         | <a href="#">6-28</a>  |
|                     | ■ Special Dialing Option           |                       |
|                     | — hot-line                         |                       |
|                     | — default                          |                       |
|                     | — blank                            |                       |
|                     | ■ Hotline Destination AD dial code |                       |
| Data Modules        |                                    |                       |
|                     | ■ AD List1 (on all data forms)     | <a href="#">6-28</a>  |
| Data Line           |                                    |                       |
|                     | ■ Special Dialing Option           | <a href="#">6-230</a> |
|                     | — hot-line                         |                       |
|                     | — default                          |                       |
|                     | — blank                            |                       |
|                     | ■ AD Dial Code                     |                       |
| Processor Interface |                                    |                       |
|                     | ■ Special Dialing Option           | <a href="#">6-246</a> |
|                     | — hot-line                         |                       |
|                     | — default                          |                       |
|                     | — blank                            |                       |
|                     | ■ AD Dial Code                     |                       |

*Continued on next page*

**Required forms — Continued**

| Form               | Field  | Page                  |
|--------------------|--|-----------------------|
| PDM, TDM           | <ul style="list-style-type: none"> <li>■ Special Dialing Option                             <ul style="list-style-type: none"> <li>— hot-line</li> <li>— default</li> <li>— blank</li> </ul> </li> <li>■ AD dial code</li> </ul> | <a href="#">6-243</a> |
|                    | <hr/>  |                       |
| Netcon Data Module | <ul style="list-style-type: none"> <li>■ Special Dialing Option                             <ul style="list-style-type: none"> <li>— hot-line</li> <li>— default</li> <li>— blank</li> </ul> </li> <li>■ AD dial code</li> </ul> | <a href="#">6-245</a> |
|                    | <hr/>  |                       |
| X.25               | <ul style="list-style-type: none"> <li>■ Special Dialing Option                             <ul style="list-style-type: none"> <li>— hot-line</li> <li>— default</li> <li>— blank</li> </ul> </li> <li>■ AD dial code</li> </ul> | <a href="#">6-249</a> |
|                    | <hr/>  |                       |
| 7500               | <ul style="list-style-type: none"> <li>■ Special Dialing Option                             <ul style="list-style-type: none"> <li>— hot-line</li> <li>— default</li> <li>— blank</li> </ul> </li> <li>■ AD dial code</li> </ul> | <a href="#">6-252</a> |
|                    | <hr/>  |                       |

**Detailed description**

The system automatically places Data Hotline calls to preassigned extensions or off-premises numbers. Calling terminals are connected to the system by a data module. Users should store the destination number in the abbreviated dialing list for future reference.

**Considerations**

- Data Hotline offers fast and accurate call placement to data endpoints. Users who frequently call the same endpoint can automatically place the call by going off-hook.

## Interactions

---

- Call Forwarding — All Calls

A Data Hotline caller cannot activate both Call Forwarding and Data Hotline. Dialing the Call Forwarding feature access code (FAC) causes activation of the Data Hotline instead.

- Data Terminal (Keyboard) Dialing

Normal terminal-dialing text displays for Data Hotline calls except the initial-dial prompt normally given on off-hook for origination.

## Data Privacy

---

Data Privacy protects analog data calls from being disturbed by any of the system's overriding or ringing features.

### How to administer Data Privacy

---

#### Required forms

---

| Form                      | Field                      | Page                  |
|---------------------------|----------------------------|-----------------------|
| Feature Access Code (FAC) | ■ Data Privacy Access Code | <a href="#">5-113</a> |
| Class of Service          | ■ Data Privacy (0–15)      | <a href="#">5-81</a>  |
| Station                   | ■ COS (0–15)               | <a href="#">6-28</a>  |

### Detailed description

---

To activate this feature, the user dials the activation code at the beginning of the call.

### Considerations

---

- Connections involving one or more digital data endpoints (data module) are protected from receiving system-generated tones.
- Data Privacy applies to both voice and data calls. You can activate Data Privacy on Remote Access calls, but not on other incoming trunk calls. Data Privacy is canceled if a user transfers a call, is added to a conference call, is bridged onto a call, or disconnects from a call. You can activate Data Privacy on calls originated from attendant consoles.

### Interactions

---

- Attendant Call Waiting and Call Waiting Termination  
If Data Privacy is active, Call Waiting is denied.
- Bridged Call Appearance — Single-Line Voice Terminal  
If you activate Data Privacy or assign Data Restriction to a station involved in a bridged call and the primary terminal or bridging user attempts to bridge onto the call, this action overrides Data Privacy and Data Restriction.
- Busy Verification  
Busy Verification cannot be active when Data Privacy is active.

- **Intercom — Automatic and Dial**

An extension with Data Privacy or Data Restriction active cannot originate an intercom call. The user receives an intercept tone.

- **Music-on-Hold Access**

If a user places a call with Data Privacy on hold, The user must withhold Music-on-Hold to prevent the transmission of tones that a connected data service might falsely interpret as a data transmission.

- **Priority Calls**

If a user activates Data Privacy, Priority Calls are denied on analog voice terminals. However, Priority Calls appear on the next available line appearance on multiappearance voice terminals.

## Data Restriction

---

Data Restriction protects analog-data calls from being disturbed by any of the system's overriding or ringing features.

### How to administer Data Restriction

---

#### Required forms

---

| Form         | Field   | Page                  |
|--------------|---|-----------------------|
| Station      | <ul style="list-style-type: none"> <li>■ Data Restriction</li> <li>— prevent tones = y</li> </ul>       | <a href="#">6-28</a>  |
| Trunk Groups | <ul style="list-style-type: none"> <li>■ Data Restriction (all)</li> <li>— prevent tones = y</li> </ul> |                       |
| — Access     |   | <a href="#">7-150</a> |
| — APLT       |   | <a href="#">7-156</a> |
| — CO         |   | <a href="#">7-168</a> |
| — CPE        |   | <a href="#">7-174</a> |
| — DID        |   | <a href="#">7-178</a> |
| — FX         |   | <a href="#">7-193</a> |
| — ISDN-PRI   |   | <a href="#">7-219</a> |
| — RLT        |   | <a href="#">7-252</a> |
| — Tandem     |   | <a href="#">7-257</a> |
| — Tie        |   | <a href="#">7-262</a> |
| — WATS       |   | <a href="#">7-268</a> |

### Detailed description

---

When you administer Data Restriction to an extension or trunk group, the system cannot gain access to, or superimpose tones onto, the protected call.

Once you administer Data Restriction for an analog or multiappearance voice terminal or trunk group, the feature is active on all calls to or from the terminal or trunk group.

### Considerations

---

- Connections involving one or more digital-data endpoints (data modules) are already protected from receiving system-generated tones. Data Restriction is not needed for these connections.

- Data Restriction applies to both voice and data calls.
- Do not assign Data Restriction to attendant consoles.

## Interactions

---

- Attendant Call Waiting and Call Waiting Termination  
If Data Restriction is active, Call Waiting is denied.
- Busy Verification  
Busy Verification cannot be active when Data Restriction is active.
- Call Vectoring  
Music plays on calls from data-restricted extensions when the calls receive music as the result of a wait-time vector step.
- Intercom — Automatic and Dial  
An extension with Data Privacy or Data Restriction activated cannot originate an intercom call. The user receives an Intercept tone.
- Music-on-Hold Access  
If a user places a call with Data Restriction on hold, The user must withhold Music-on-Hold to prevent the transmission of tones that a connected data service might falsely interpret as a data transmission.
- Priority Calls  
Priority Calls are allowed if the analog station is idle. Call Waiting (including Priority Call Waiting) is denied if the station is busy. However, Priority Calls appear on the next available line appearance on multiappearance voice terminals.
- Service Observing  
A data-restricted call cannot be service observed.



## Data-Only Off-Premises Extensions

---

Data-Only Off-Premises Extensions allows users to establish data calls involving data communications equipment (DCE) or digital terminal equipment (DTE) located remotely from the system site using DATAPHONE digital service or other private-line data facilities.

### How to administer Data-Only Off-Premises Extensions

---

#### Required forms

---

| Form                        | Field | Page                  |
|-----------------------------|-------|-----------------------|
| Data Module Processor/Trunk | ■ All | <a href="#">6-243</a> |

---

### Detailed description

---

A Data-Only Off-Premises Extension uses an on-premises modular trunk data module (MTDM). The system communicates with remote data equipment through the private-line facility linking the on-premises MTDM and the remote data equipment.

The TDM and DCE or DTE constitute a digital-data endpoint. Place data calls to this type of data endpoint using Voice Terminal Dialing or Data Terminal (Keyboard) Dialing. Since there is no voice terminal at the remote site, originate data calls from the remote data terminal using Keyboard Dialing only. If you use computer-generated dialing, you must follow Keyboard Dialing protocol.

### Considerations

---

- Data-Only Off-Premises Extensions provides digital-data endpoints located off-premises through a TDM located on-premises. Communications to or from TDM (and off-premises equipment) must be through an on-premises Processor Data Module or Digital Terminal Data Module. The system does not support communications between two TDMs. Modem Pooling is similar to a TDM, it cannot be used on calls to or from a Data-Only Off-Premises Extension.

## Interactions

---

- Voice Terminal Dialing

An on-premises multiappearance voice terminal may have a Data Extension button associated with the TDM used for a Data-Only Off-Premises Extension. The voice-terminal user and the remote user share control of the data module. Actions of the user at the voice terminal may affect the remote user.

- 1-Button Transfer to Data

The voice-terminal user can transfer a call to the Data-Only Off-Premises Extension. The Data Extension button lamp on the voice terminal lights and the Call in Progress lamp on the data module lights during a data call.

- Data Call Preindication

The multiappearance voice-terminal user presses the idle associated Data Extension button to reserve a data module. The data module is busy to all other users. When the user reserves a data module, the lamp associated with the Data Extension button winks and lights at any other associated voice terminals. A remote user receives the BUSY message when attempting to originate a call.

- Return-to-Voice

To establish a data call, the voice-terminal user presses the associated busy Data Extension button to transfer the call to the voice terminal. The data module associated with the Data Extension button is disconnected from the call. The Call in Progress lamp on the data module goes dark.

## Default Dialing

---

Default Dialing provides data-terminal users who dial a specific number the majority of the time a very simple method of dialing that number. Normal data terminal dialing and alphanumeric dialing are unaffected.

### How to Administer Default Dialing

---

#### Required forms

---

| Form                     | Field                      | Page                  |
|--------------------------|----------------------------|-----------------------|
| Abbreviated Dialing      |                            |                       |
| — Enhanced               | ■ All                      | <a href="#">5-2</a>   |
| — Group                  | ■ All                      | <a href="#">5-5</a>   |
| — System                 | ■ All                      | <a href="#">5-11</a>  |
| — Personal               | ■ All                      | <a href="#">5-8</a>   |
| — 7103A                  | ■ All                      | <a href="#">5-14</a>  |
| Data Modules (all forms) |                            |                       |
|                          | ■ Special Dialing Option   | <a href="#">6-226</a> |
|                          | ■ Abbreviated Dialing List |                       |
|                          | ■ AD Dial Code             |                       |

---

### Detailed description

---

Default Dialing enhances data terminal (keyboard) dialing by allowing a data-terminal user to place a data call to a preadministered destination by either pressing a Return at the DIAL: prompt (for data terminals using DCP data modules) or typing d and pressing Return at the CMD: prompt (for data terminals using ISDN-BRI data modules). The data-terminal user with a DCP data module can place calls to other destinations by entering the complete address after the DIAL: prompt (normal data terminal dialing or alphanumeric dialing). The data-terminal user with an ISDN-BRI data module can place calls to other destinations by typing d, a space, the complete address, and Return after the CMD: prompt.

#### NOTE:

DU-type hunt groups connecting the system to a terminal server on a host computer have hunt-group extensions set to no keyboard dialing.

For the AT command interface supported by the 7400A/7400B/8400B data module, to dial the default destination, enter the ATD command (rather than press return).

## Interactions

---

- Data Call Setup

Default Dialing enhances data terminal (keyboard) dialing by allowing data-terminal users to place data calls to a preadministered destination. Users either press Return at the DIAL: prompt (for DCP) or type d and press Return at the CMD: prompt (for ISDN-BRI).

## Demand Print

---

Demand Print allows voice-terminal users to print their own undelivered messages without calling the message center.

### How to administer Demand Print

---

#### Required forms

---

| Form                      | Field   | Page                  |
|---------------------------|---|-----------------------|
| Station (multiappearance) | ■ Button/Feature Button Assignments<br>— print-msgs | <a href="#">6-14</a>  |
|                           | ■ Security Code                                     |                       |
| Feature Access Code (FAC) | ■ Print Messages Access Codes                       | <a href="#">5-113</a> |

### Interactions

---

None

## Dial Access to Attendant

---

Dial Access to Attendant allows voice-terminal users to reach an attendant by dialing an attendant-access code. Attendants can then extend the call to a trunk or to another voice terminal.

### How to administer Dial Access to Attendant

---

#### Required forms

---

| Form             | Field               | Page                 |
|------------------|---------------------|----------------------|
| Dial Plan Record | ■ First Digit Table | <a href="#">5-99</a> |

### Detailed description

---

The attendant-access code length is administrable and may be any 1 or 2 digit number; the default is 0. To assign a digit other than 0, enter **attd** in the appropriate row of the First Digit Table, in the Length=1 column. To assign a 2-digit code, enter **misc** in the appropriate row of the First Digit Table on the Dial Plan form. Then complete the Second Digit form for this number. See [“Dial Plan” on page 4-311](#) for more information.

### Interactions

---

- Class of Restriction  
If a voice terminal's COR restricts the user from originating calls, this prohibits the placement of any calls, including Dial Access to Attendant.
- Conference  
If a voice-terminal user calls the attendant by dial access, the attendant cannot add that user to an existing conference.

## Dial Plan

---

This is the system's guide to digit translation. When the system receives dialed digits, it must know what to expect next based on the digits received so far. For example, if a voice-terminal user dials 4, the system must know how many more digits to expect before the call is processed.

A feature access code (FAC) extension or trunk access code (TAC) cannot be assigned to a feature if it is not consistent with the dial plan.

### How to administer Dial Plan

---

#### Required forms

| Form                         | Field                              | Page                   |
|------------------------------|------------------------------------|------------------------|
| Dial Plan Record             | ■ All                              | <a href="#">5-99</a>   |
| Second Digit Table           | ■ All                              | <a href="#">5-264</a>  |
| Uniform Dialing Plan         | ■ Plan Number<br>■ Extension Codes | <a href="#">12-121</a> |
| Extension Number Portability | ■ All                              | <a href="#">12-70</a>  |
| Extended Trunk Access        | ■ Call Screening Entry             | <a href="#">12-67</a>  |
| Route Pattern                | ■ All                              | <a href="#">8-67</a>   |
| Trunk Group                  | ■ Digit Treatment<br>■ Digits      | <a href="#">7-115</a>  |
| Feature Access Code (FAC)    | ■ As required                      | <a href="#">5-113</a>  |
| Attendant Console            | ■ As required                      | <a href="#">5-35</a>   |

### Detailed description

---

The dial plan provides information to the switch on what to do with dialed digits. Tables define the intended use of a code beginning with a specific first digit or pair of digits. These digits tell the system how many digits to collect before processing the full digit string.

For example, a digit string beginning with 8 may tell the system to wait for 4 more digits because this is the first digit of a 5-digit internal extension. The choices of a first digit are 0–9, \*, and #. Permissible codes and the allowable number of digits are listed below.

- Attendant (ATTD)
- Users can access the attendant group by dialing the single digit 0. Or you can set the Dial Plan Record form so that some other digit is used to access the attendant (for example, 9 is common in Italy). Dial-access numbers to the attendant can range from 0 to 9 with a length of one or more digits. In addition, the system provides for Individual Attendant Access by assigning each attendant an individual extension.
- Dial Access Codes (DAC) — TAC or FAC

TACs or FACs can be from 1 to 4 digits and any number from 1 to 9. For example, 9 could be used for local trunks, 8 for WATS trunks, and 7 for tie trunks. The \* and # can be used as the first digit for TACs. TACs for DCS trunk groups and trunk groups controlled by DCS can be a maximum of 3 digits.
- Extensions (EXT)

Flexible numbering allows 1-, 2-, 3-, 4-, or 5-digit extensions.
- Feature Access Codes (FAC) only

You can use 1 to 4 digits for FACs. If you use \* or # as part of a FAC, they must be the first digit. For example, \* 2 could be used to activate Call Forwarding All Calls and # 2 could be used to deactivate Call Forwarding All Calls. However, you cannot use 2\* or 2#.
- Miscellaneous Code (MISC)

The 1-digit Miscellaneous Code indicates that any dialed digit string starting with the first digit uses the second digit table for interpretation. The associated entry on the second digit table can be a FAC, trunk access code, attendant access code, or extension.
- Prefixed Extensions (PEXT)

The dial plan does not route on the first digit prefix (0 to 9), but routes on the rest of the digits.

You can also administer a Uniform Dial Plan (UDP) as part of the dial plan to be shared among a group of switches. If you establish a UDP, make all extensions the same length (4 or 5 digits). So that calls route to the desired switch, a UDP requires the following information:

- A PBX code, which represents the first 1 to 5 digits of a 4-digit or 5-digit extension and can range from 0 to 9xxxx with a maximum of 50,000 PBX codes on R5r and later or 20,000 PBX codes on R5si/csi and later.
- An RNX, which is associated with the PBX code and is used to select an AAR pattern for the call. This information is required for each PBX code. The 3-digit RNX can be an AAR location code or, for ENP calls, an ENP code.
- A PBX ID (1 to 63), which represents a specific switch (optional).
- Whether or not the PBX code is local to this system (optional).



## Interactions

---

All dial-access features and services provided by the system require the dial plan.

- ISDN-BRI

When an ISDN-BRI station dials sufficient digits to route a call, but the call could route differently if additional digits were dialed, the station does not recognize the Conference or Transfer buttons. The user must delay dialing for 3 seconds or dial # to indicate that the call can be routed based on the digits already dialed. The Conference or Transfer buttons then are recognized and the switch completes the operation.

- MF Signaling

Flexible numbering is supported in countries using R2-MFC trunk signaling without Group II tones. Different-length extensions can exist as long as the extensions have different first digits.

## Distinctive Ringing

Distinctive Ringing provides several ringing cycles to help voice terminal users and attendants distinguish between incoming call types.

### How to administer Distinctive Ringing

#### Required forms

| Form                              | Field                             | Page                  |
|-----------------------------------|-----------------------------------|-----------------------|
| Feature-Related System Parameters | ■ Internal                        | <a href="#">5-123</a> |
|                                   | ■ External                        |                       |
|                                   | ■ Priority                        |                       |
|                                   | ■ Attendant Originating Calls     |                       |
|                                   | ■ Update Transferred Ring Pattern |                       |
| Station (single-line)             | ■ Distinctive Audible Alert       | <a href="#">6-4</a>   |

### Detailed description

You can administer system-wide distinctive-ringing cycles for the three basic call types. Most installations use 1-burst for internal calls, 2-burst for external calls, and 3-burst for priority calls. There are also non-administrable ringing signals for Automatic and Dial Intercom calls, Manual Signaling, and Redirect Notification.

**Table 4-72. Distinctive Ringing Defaults for Country Code 1**

| Default Ringing Cycle                        | Call Type  | User                        |
|--|--|-----------------------------|
| 1-burst ringing (1.2 on, 4.0 off repetitive) | Internal voice terminal, internal tie trunk, and Remote Access | All voice terminals         |
|  | Intercom   | Single-line voice terminals |

*Continued on next page*

**Table 4-72. Distinctive Ringing Defaults for Country Code 1 — Continued**

| Default Ringing Cycle  | Call Type  | User                            |
|--|--|---------------------------------|
| 2-burst ringing (0.2 on, 0.4 off; 0.6 on, 4.0off repetitive)                   | Attendant-extended, attendant-originated, and incoming trunk, including external tie trunk | All voice terminals             |
| 3-burst ringing (0.2 on, 0.1 off; 0.2 on, 0.1 off; 0.6 on, 4.0 off repetitive) | Automatic Callback, Priority Calling, and Ringback Queuing callback                        | Single-line voice terminals     |
| 3-burst ringing (0.1 on, 0.1 off; 0.1 on, 0.3 off; 0.6 on, 4.0 off repetitive) | Automatic Callback, Priority Calling, and Ringback Queuing callback                        | Multiappearance voice terminals |

**Table 4-73. Non-Administrable Signals**

| Default Ringing Cycle                           | Call Type             | User                            |
|---|-----------------------|---------------------------------|
| Unmodulated tone (0.6 on, 4.6 off repetitive)   | Intercom              | Multiappearance voice terminals |
| Single unmodulated tone (0.2 on non-repetitive) | Manual Signaling      | Multiappearance voice terminals |
| Single ring (0.2 on non-repetitive)             | Redirect Notification | All voice terminals             |

**Table 4-74. Non-Administrable Cycles at an Attendant Console for Country Code 1**

| Default Ringing Cycle:                         | Call Type  |
|--|--|
| Low-pitched tone (0.4 on, 1.2 off repetitive)  | Incoming call  |
| High-pitched tone (0.4 on, 1.2 off repetitive) | Attendant recall and anytime a call associated with a timed reminder interval returns to the console |
| Low-pitched tone (0.25 on, 0.8 off repetitive) | Waiting in queue   |

## **Considerations**

---

- The 2- and 3-burst ringing is optional only on single-line voice terminals. If Distinctive Ringing is disabled, the system generates a 1-burst repetitive tone for all incoming calls. This is useful for equipment interfaced by analog lines, especially if you use off-premises station.
- A single distinctive ring cycle is used for each new incoming call to an off-hook voice terminal or headset. The system alerts a CALLMASTER terminal with a single ring cycle whenever either the headset or the handset is plugged into the headset jack.

## **Interactions**

---

- **Personalized Ringing**  
The called party hears the user-selected ringing pattern for the distinctive ring cycles.

## Dual DCP I-Channels

---

Dual Digital Communications Protocol (DCP) I-channels support the use of dual DCP I-channels for AUDIX networking. In this case, networking refers to the ability to send data files between AUDIX systems, not to communications with the switch.

### How to administer Dual DCP I-Channels

---

#### Required forms

---

| Form              | Field | Page                  |
|-------------------|-------|-----------------------|
| Data Module (PDM) | ■ All | <a href="#">6-243</a> |

### Detailed description

---

Each AUDIX has 2 DCP connections and 2 external (EIA 232C) connections that can be used for networking. Each external connection is capable of running one communications session. Data support for both I-channels increases the simultaneous AUDIX networking capacity from 4 ports to 6 ports.

You administer Dual DCP I-Channel data modules as processor data modules (PDMs) with both the primary and secondary data module having the same port location but different extensions.

If the primary data module is a TTI port, the secondary data module cannot be administered because TTI cannot be used on a secondary data module. Similarly, if you already administered the secondary data module, TTI cannot be administered on the primary data module.

### Interactions

---

None

## Emergency Access to the Attendant

Emergency Access to the Attendant alerts an attendant if a station remains off-hook for more than the administered period of time. It also enables a user to place an emergency call to an attendant.

### How to administer Emergency Access to the Attendant

#### Required forms

| Form                              | Field   | Page                  |
|-----------------------------------|---|-----------------------|
| Class of Service                  | ■ Off-Hook Alert  | <a href="#">5-81</a>  |
| Console Parameters                | ■ Queue Priorities  | <a href="#">5-86</a>  |
| Feature-Related System Parameters | <ul style="list-style-type: none"> <li>■ Reserved Slots for Attendant Priority Queue</li> <li>■ Time before Off-Hook Alert</li> <li>■ Emergency Access Redirection Extension</li> </ul> | <a href="#">5-123</a> |
| Hospitality                       | <ul style="list-style-type: none"> <li>■ Extension of Journal/Schedule Printer</li> <li>■ Time of Scheduled Emergency Access Summary Report</li> </ul>                                  | <a href="#">10-30</a> |
| Attendant Console                 | Feature Button Assignments <ul style="list-style-type: none"> <li>■ — em-acc-att</li> </ul>   | <a href="#">5-35</a>  |
| Feature Access Code (FAC)         | ■ Emergency Access To Attendant Access Code   | <a href="#">5-113</a> |

### Detailed description

Emergency calls can be placed automatically by the system or dialed by system users. Such calls can receive priority handling by the attendant.

Place emergency calls to the attendant in the following ways:

- Automatically by the system

Assign a voice terminal the Off-Hook Alert option via COS. If the terminal is left off-hook until intercept timeout, the (administrable) off-hook alerting timer starts. If the terminal is still off-hook when the timer expires, an emergency call is automatically placed to the attendant.

## 4 Basic Features

### *Emergency Access to the Attendant*

Page 4-319

- Dial access by a system user

A user can place an emergency call to the attendant by dialing the Emergency Access to the Attendant feature-access code.

When an emergency call is placed, one of the available attendants receives visual and audible notification of the call. If all attendants are busy, the call enters a queue for emergency calls. Calls can be administered to redirect to another extension if the queue is full.

An emergency call causes the following to occur:

1. The system selects the first available attendant to receive the call.
2. The attendant hears the emergency tone and sees the lamp associated with the Emergency button, if assigned, light. If the console does not have emergency-tone capability, the attendant hears normal ringing and sees the display flash.
3. The attendant display shows:
  - Calling-party identification
  - Calling-party extension
  - How many emergency calls remain in queue

An attendant can place a normal call on hold to handle an emergency call.

An audit record is created for each emergency call. This record includes:

- Extension where the call originated
- The attendant or attendant group that answered the call
- Time of the call
- The following known call results:
  - Call Completed — Call answered at attendant or LDN night extension.
  - Queue Full — Emergency-access queue is full; tries to redirect the call to an emergency-access redirection extension.
  - No Attd — No active attendants are available to receive the call; tries to redirect the call to an emergency-access redirection extension.
  - Redirected Answered — Call is answered by the emergency-access redirection extension.
  - No Redirection Ext. — Could not redirect the call to the emergency-access redirection extension because none are administered.
  - Attd Night Service — System is in night service. Will try to redirect the call to attendant night service.

## 4 Basic Features

### *Emergency Access to the Attendant*

Page 4-320

- Failed — Caller drops the call before it can be answered. Call was either waiting in the attendant emergency queue, ringing at an attendant console, or ringing at the LDN night extension.
- Redirected Abandoned — Caller drops the call before it can be answered. Call had been redirected to the emergency-access redirection extension.

You can generate an Emergency Access Summary Report of the emergency audit records. Schedule the report for printing once a day at a designated printer. If the switch has a journal printer Emergency Access to the Attendant audit records print as the calls occur.

You can monitor emergency-access calls by displaying them at the administration terminal. The command for listing emergency call events is **list emergency**. You can use a from and to time option with the command. For example, if the command **list emergency 8:00am 12:00pm** was entered, those emergency call events display on the management terminal.

## Considerations

- The Emergency tone cannot be silenced except by answering the emergency call.
- The system should have at least one day and one night attendant (or night service station) for this feature to be useful at all times.

## Interactions

- Centralized Attendant Service

For a branch with CAS in effect, an emergency call reroutes to the branch attendant group. If the branch does not have an attendant or if the branch is not in CAS Backup Service, the call is denied.

If the branch PBX is in CAS Backup Service, an emergency call routes to the backup position and is handled as any other nonemergency call.

- COR

An Emergency Access to the Attendant call overrides all restrictions on the COR.

- Individual Attendant Access

An emergency call cannot be placed to an individual attendant.

Emergency calls have priority over other calls to an individual attendant, only if they are assigned a higher priority on the Console Parameters form.

- Intercept Treatment

Intercept With Off-Hook Alert automatically activates Emergency Access to the Attendant.



## 4 Basic Features

### *Emergency Access to the Attendant*

Page 4-321

- Inter-PBX Attendant Service

For branches with Inter-PBX Attendant Service in effect, an emergency call reroutes to the local attendant group. If the branch does not have an attendant or if the attendant is not on duty, the call is denied.

- Night Service

When Night Service is in effect, emergency calls route to the night destination. Such calls are included on the Emergency Audit Record, and the call is designated as Emergency Night in the audit trail.

When an attendant is in night service, you must assign either a night station or a redirect extension. Otherwise emergency calls to the night attendant hear a busy tone.

- Priority Queue

You can change the priority of emergency calls to equal or lower than that of other types of calls.

- Remote Access

An emergency call cannot be placed through Remote Access.

- Restriction — Controlled

An emergency call overrides any controlled restriction.

## Enhanced Voice Terminal Display

---

The Enhanced Voice Terminal Display feature allows you to choose the character set that you want to see in DEFINITY ECS softkeys and display terminals. In addition to the standard Roman character set, you can choose either Katakana or European characters.

The feature supports two groups of enhanced character display sets. The set that you use is determined by the terminal type, and not by administration.

- Group1 (default) contains the Roman alphabet, numerals, and special characters found on the standard US English keyboard.
- Group2 contains one of two alternate character sets:
  - Group2a contains Katakana characters as well as some European characters and other symbols.
  - Group2b contains characters required to display many European languages.

### How to administer Enhanced Voice Terminal Display

---

You activate this feature on a system-wide basis as described below.

#### Task 1

To administer voice terminal displays in Group 2 characters, A Lucent Technologies employee must enter **y** in the following field.

#### Required forms

| Form                                 | Field                             | Page                  |
|--------------------------------------|-----------------------------------|-----------------------|
| System Parameters<br>Country-Options | ■ Enhanced 84xx Terminal Display? | <a href="#">5-271</a> |

#### Task 2

You can now enter the Roman characters that produce the corresponding Group2 characters on the terminal display.

The system accepts entries as Roman characters preceded by a tilde (~), and maps them to corresponding Katakana or European characters. (You can still enter Roman characters after you have activated this feature, just as you normally would.)

Once you have activated the feature, add or update the fields that you want to display using the Group 2 character set.

1. Retrieve the appropriate form.
2. Move to the display field that you want to add or change.
3. Enter a tilde (~) where you want to start the display in Group2 characters. See [Table 4-75](#), [Table 4-76](#), and [Table 4-77](#) for Group1 to Group2 character-map information. Use the character map on the following pages to determine the Roman characters that correspond to the Group2 characters you want.
4. Type the Roman characters in the display field.
5. If you want to end the display of Group2 characters and continue with Roman characters, type another tilde, then continue using the Roman set. If you want the entire field to display in Group2 characters, you can omit the tilde from the end of the field.
6. Submit the form.

### How to combine Katakana characters

The Katakana characters that combine symbols do not appear as single characters in the terminal-display set. To display these characters, you must use a combination of characters.

[Table 4-75](#) shows a few examples of what you enter to display these characters.

**Table 4-75. Examples of how to combine characters**

| When you enter these characters | This displays on the voice terminal |
|---------------------------------|-------------------------------------|
| ~2<@^                           | ÒÃàP                                |
| ~2<@^~, Max                     | ÒÃàP, Max                           |
| ~N_                             | îß                                  |
| Pe~n~a                          | Peña                                |
| Fr~a~ulein                      | Fräulein                            |

Characters appear on the display terminal in the order in which you enter them. If you want the display to read right to left, enter the characters in reverse order on the form.

### Considerations

If you turn the feature off at the system level after Group2 display has been administered, you must change the display field values back to the appropriate Group1 characters.

## What terminal types can you use?

Whether your system displays Group2a or Group2b depends on the terminal types attached to the ECS. Each character set for Enhanced Voice Terminal Display requires specific firmware in the terminal, based on the Group2 character set that you want to display.

### NOTE:

It is very important to use terminals with the same firmware type across your entire system. That is, use only Group2a *or* Group2b terminals. Otherwise, the displays will not appear as expected. Your Lucent Technologies representative can ensure that you have the firmware types appropriate for your system.

## Trouble Shooting

| Symptom   | Cause and Solution  |
|---|---|
| Characters that display are not what you thought you entered.                           | This feature is case sensitive. Check the table to make sure that you entered the right case.   |
| You entered “~c”, and “*” appears on the display instead.                               | Lower-case “c” has a specific meaning in the DEFINITY system, and therefore cannot be mapped to any other character. An asterisk “*” appears in its place.  |
| You entered “~->” or “~<-” and nothing appears on the display.                          | These characters do not exist as single keys on the standard US-English keyboard. Therefore the system is not programmed to handle them.  |
| Enhanced display characters appear in fields that you did not update.                   | If an existing display field contains a tilde (~) followed by Roman characters, and you update and submit that form after this feature is activated, that field will display the enhanced character set.                        |
| Nothing displays on the terminal at all.  | Some unsupported terminals do not display anything if a special character is presented. Check the model of display terminal that you are using.   |
| You entered a character with a descender and part of it appears cut off in the display. | Some of the unused characters in Group2a have descenders that do not appear entirely within the display area. These characters are not included in the character map. For these characters (g,j,p,q,y), use Group1 equivalents. |

## Interactions

---

### Internal feature interactions

- Data Call Setup

Not supported.

- Directory

The Enhanced Voice Terminal Display feature interacts with the Directory feature to include names administered with enhanced display characters in the directory. Terminal users can select directory entries displayed in the Group2 character set by using the Directory and Next buttons on their display terminals, and can use the "\*" to indicate special characters in a directory search. However, they cannot input directory entries using the voice terminal because of the special characters used.

- ISDN

The system supports enhanced display characters for ISDN calls. These characters display correctly for calls between properly administered DEFINITY switches with the same terminal types at both ends.

- Leave Word Calling — Adjunct

Not supported

- Message Retrieval — Print Messages (Demand Print)

Not supported

- OSSI

OSSI displays the literal value of the display field, not the Group2 characters.

- Voice Terminal Display

If the terminal hardware is compatible, all features that display administered data are supported for enhanced display.

### External feature interactions

- Adjunct Switch Applications Interface (ASAI)

Information sent from the DEFINITY ECS to any adjunct is the literal value of the field as administered, not the enhanced display format. Because the adjunct has no way to interpret this into special fonts, the resulting display appears as a string of random characters — for example, as "2<@^."

The ASAI-Query Names Database and ASAI-Accessed BCMS Data features also receive names as described above.

## 4 Basic Features

### Enhanced Voice Terminal Display

Page 4-326

#### ■ AUDIX

The following AUDIX products operate normally with Enhanced Voice Terminal Display enabled:

- Basic R1 AUDIX
- Embedded DCIU AUDIX
- Embedded DCP AUDIX (requires R3.2 or greater)

#### ■ AUDIX Voice Power/AUDIX Voice Power Lodging

Not supported

#### ■ DCS

This feature is supported in a DCS environment. All switches in the network must have the enhanced character set enabled *and must have* the same software load installed on each server and terminals with the same firmware type.

#### ■ ECMA and QSIG Networking

If two DEFINITY servers are administered for enhanced display for terminals using the same character group, this feature is supported. It is not supported between a DEFINITY ECS and a non-DEFINITY switch.

#### ■ Look Ahead Interflow

This feature can use the enhanced character set, but terminal firmware must match the administered display group.

#### ■ Monitor 1 and OneVision

Monitor 1 and OneVision receives ASCII characters as administered.

#### ■ Novell Telephony Services

Not supported

#### ■ Passageway Direct Connect

Not supported

#### ■ VuStats

If this feature is used with unsupported terminals, the enhanced character set may cause screens to be cleared or may display false information.

Group1 to Group2a character map

Table 4-76. Group 1 to Group 2a

| Group 2a | Roman | Group 2a | Roman |
|----------|-------|----------|-------|
| space    | space | ∅        | 8     |
| û        | !     | Ù        | 9     |
| ý        | “     | Ú        | :     |
| þ        | #     | Á        | ;     |
| ü        | \$    | Ã        | <     |
| À        | %     | Å        | =     |
| Æ        | &     | Â        | >     |
| Ç        | ‘     | Ä        | ?     |
| È        | (     | à        | @     |
| É        | )     | á        | A     |
| Ê        | *     | â        | B     |
| Ë        | +     | ã        | C     |
| Ì        | ,     | ä        | D     |
| Í        | -     | å        | E     |
| Î        | .     | æ        | F     |
| Ï        | /     | ç        | G     |
| Ð        | 0     | è        | H     |
| Ñ        | 1     | é        | I     |
| Ò        | 2     | ê        | J     |
| Ó        | 3     | ë        | K     |
| Ô        | 4     | ì        | L     |
| Õ        | 5     | í        | M     |

Continued on next page

4 Basic Features

Enhanced Voice Terminal Display

Table 4-76. Group 1 to Group 2a — Continued

|   |   |    |   |
|---|---|----|---|
| Ö | 6 | î  | N |
| × | 7 | ï  | O |
| ð | P | ρ  | f |
| ñ | Q | g  | g |
| ò | R | √  | h |
| ó | S | -1 | i |
| ô | T | j  | j |
| õ | U | *  | k |
| ö | V | ϕ  | l |
| ÷ | W | £  | m |
| ø | X | ñ  | n |
| ù | Y | ö  | o |
| ú | Z | p  | p |
| Û | [ | q  | q |
| Ü | \ | θ  | r |
| Ý | ] | ∞  | s |
| Þ | ^ | Ω  | t |
| β | _ | ü  | u |
| α | ' | Σ  | v |
| ä | a | π  | w |
| β | b | ¯x | x |
| μ | d | y  | y |

For Group2a, the z, { and | characters map to Kanji characters as follows:

z — symbol for 1,000



4 Basic Features

Enhanced Voice Terminal Display

{ — symbol for 10,000

| — symbol for Yen

**Group1 to Group2b character map**

**NOTE:**

Some of the characters in the following map appear in only upper- or lower-case — for example, i, Ê, ø, and others. These display the same for both upper- and lower-case.

**Table 4-77. Group1 to Group2b**

| Group 2b | Roman | Group 2b | Roman |
|----------|-------|----------|-------|
| Ì        | space | »        | 8     |
| Ô        | !     | Ë        | 9     |
| ”        | “     | £        | :     |
| .        | #     | š        | ;     |
| ‡        | \$    | >        | <     |
|          | %     | -        | =     |
|          | &     | Ê        | >     |
| È        | ‘     | ”        | ?     |
| Ë        | (     | Ó        | @     |
| Ê        | )     | Â        | A     |
| Š        | *     | ¼        | B     |
| œ        | +     | ,        | C     |
| ”        | ,     | °        | D     |
| ž        | -     |          | E     |
| i        | .     | Í        | F     |
| Ú        | /     | 3        | G     |
| Õ        | 0     | Í        | H     |
| œ        | 1     | «        | I     |

*Continued on next page*

4 Basic Features

Enhanced Voice Terminal Display

Table 4-77. Group1 to Group2b — Continued

| Group 2b | Roman | Group 2b | Roman |
|----------|-------|----------|-------|
| Ð        | 2     | -        | J     |
| ı        | 3     | -        | K     |
| ı        | 4     | ÿ        | L     |
| /        | 5     | Ò        | M     |
| ÿ        | 6     | ý        | N     |
| ...      | 7     | i        | O     |
| Œ        | P     | š        | h     |
| Ý        | Q     | ä        | i     |
| Ð        | R     | -        | j     |
| ¬        | S     | ø        | k     |
| æ        | T     | œ        | l     |
| ÿ        | U     | Ú        | m     |
| þ        | V     | Ò        | n     |
| ð        | W     | ^        | o     |
| þ        | X     | Ã        | p     |
| å        | Y     | f        | q     |
| ÿ        | Z     | „        | r     |
| ¥        | [     | Ð        | s     |
| ÿ        | \     | æ        | t     |
| —        | ]     | ,        | u     |
| —        | ^     | Ã        | v     |
| ‘        | -     | À        | w     |
| Ï        | ‘     | -        | x     |
| ‰        | a     | ½        | y     |
| -        | b     | ç        | z     |
| °        | d     |          | {     |

Continued on next page

**Table 4-77. Group1 to Group2b — Continued**

| Group 2b | Roman | Group 2b | Roman |
|----------|-------|----------|-------|
| <        | e     | ∅        |       |
| ï        | f     | “        | }     |
| î        | g     |          |       |

### Forms that accept enhanced display characters

- Access-endpoint
- Agent-loginID
- Announcements
- Attendant
- BCMS-VuStats loginIDs
- Console-parameters
- Data-module
- Display-messages
- Display-messages auto-wakeup-dn-dst
- Display-messages call-identifiers
- Display-messages date-time
- Display-messages leave-word-calling
- Display-messages malicious-call-trace
- Display-messages miscellaneous-features
- Display-messages property-management
- Display-messages softkey-labels
- Display-messages time-of-day-routing
- Display-messages vustats
- Hunt-Group
- Listed-directory-numbers
- Paging loudspeaker
- Personal-CO-line
- Pri-endpoint

**4 Basic Features**

*Enhanced Voice Terminal Display*

*Page 4-332*

- Station
- System-parameters-hospitality
- Term-ext-group
- Trunk-group
- VDN
- VuStats-display-format

## Extended User Administration of Redirected Calls

---

Extended User Administration of Redirected Calls allows system users to change their lead-coverage path or their call forwarding from any local (on-site) or remote (off-site) location.

### How to administer Extended User Administration of Redirected Calls

---

#### Required forms for allowing a change to Call Forwarding

| Form                      | Field                                 | Page                  |
|---------------------------|---------------------------------------|-----------------------|
| Feature Access Code (FAC) | ■ Extended Call Fwd Activate Busy D/A | <a href="#">5-113</a> |
|                           | ■ Extended Call Fwd Activate All      |                       |
|                           | ■ Extended Call Fwd Deactivation      |                       |
| Class of Service          | ■ Extended Forwarding All             | <a href="#">5-81</a>  |
|                           | ■ Extended Forwarding B/DA            |                       |
| Station                   | ■ Station Security Code               | <a href="#">6-4</a>   |
| Telecommuting Access      | ■ Telecommuting Access Extension      | <a href="#">5-291</a> |

#### Required forms for allowing a choice between two lead-coverage paths

| Form                       | Field                            | Page                  |
|----------------------------|----------------------------------|-----------------------|
| Feature Access Code (FAC)  | ■ Change Coverage                | <a href="#">5-113</a> |
| Class of Restriction (COR) | ■ Can Change Coverage            | <a href="#">5-72</a>  |
| Station                    | ■ Station Security Code          | <a href="#">6-4</a>   |
|                            | ■ Coverage Path 1                |                       |
|                            | ■ Coverage Path 2                |                       |
| Telecommuting Access       | ■ Telecommuting Access Extension | <a href="#">5-291</a> |

### Detailed description

---

This feature does not change Call Coverage, nor does it change Call Forwarding All Calls or the Call Forwarding Busy/Don't Answer. It merely allows users to select between one of two previously administered coverage paths or to change their forwarding from any on-site or off-site location.

4 Basic Features

Extended User Administration of Redirected Calls

**Telecommuting access extension**

The telecommuting access extension allows users to use Extended User Administration of Redirected Calls from off-site. If you want to quickly disable the feature for *all* users, change the Telecommuting Access Extension to blank.

If you are operating in a DCS environment, you need to assign a different telecommuting-access extension to each switch and tell your users which extension they should use. Users can use Extended User Administration of Redirected Calls from any of the DCS nodes, but they need to dial the telecommuting-access extension of the node on which their station is defined before using the feature access code.

**Extended User Administration of Redirected Calls and COS and COR**

[Table 4-78](#) shows the relationship between COS and a user's ability to use call forwarding at the user's station without a security code or from any on-site or off-site location with a security code.

**Table 4-78. COS and Extended User Administration of Redirected Calls of Call Forwarding**

| If the user's COS are set to these values |                   |                                    |   | Then the user's call forwarding capability is                      |  |
|---|-------------------|------------------------------------|---|--|--|
| Call Fwd All COS                          | Call Fwd B/DA COS | Extended Call Fwd Activate All COS | Extended Call Fwd Activate Busy D/A COS | Users can forward calls from their station without a security code | Users can forward calls from their station or from another location with a security code |
| Yes                                       | Yes               | Yes                                | Yes                                     | Yes  | Yes  |
| No  | No                | Yes                                | Yes                                     | No   | Yes  |
| Yes                                       | Yes               | No                                 | No                                      | Yes  | No   |

**COR**

COR controls the use of the change coverage option of Extended User Administration of Redirected Calls. This means that, if the *Can Change Coverage* field on the COR form is set to **y**, users with that COR can use the Change Coverage FAC to change their coverage option. If the field is set to **n**, the user cannot use the Change Coverage FAC.

**End-user procedures**

These user procedures describe both on- and off-site use of the feature.

**Table 4-79. How to use Extended User Administration of Redirected Calls to change Call Coverage or activate Call Forwarding from an on-site location**

| User entry   | System response  | Explanation   |
|--|--|---|
| 1. Change Coverage FAC, Extended Call Fwd Activate Busy D/A FAC, or Extended Call Fwd Activate All FAC | <ul style="list-style-type: none"> <li>■ Dial tone</li> <li>■ Intercept tone</li> </ul>  | <p>The system is prompting for the extension.</p> <p>The user entered an FAC not defined in the system or not allowed for this user.</p>  |
| 2. Extension followed by #, or only a #  | <ul style="list-style-type: none"> <li>■ No response</li> </ul>  | The single # refers to the extension at which the user is entering data.  |
| 3. SSC for the extension entered in step 2, followed by #  | <ul style="list-style-type: none"> <li>■ Dial tone</li> <li>■ Intercept tone</li> </ul> <p>(Note: If the user has a display voice terminal, it does display the SSC or the #.)</p> | <p>The system is prompting for more information.</p> <ul style="list-style-type: none"> <li>■ The user requested an extension that does not allow extended forwarding or does not allow change coverage in its COS.</li> <li>■ The user has entered an invalid or untranslated extension. This is logged as an invalid attempt.</li> <li>■ The user entered an extension that has an inaccessible tenant partition number for the tenant partition number of the dialing station.</li> <li>■ SSC is invalid for the extension. This is logged as an invalid attempt.</li> <li>■ Interdigit timeout has occurred.</li> </ul> |
| 4. The forwarded-to extension  | <ul style="list-style-type: none"> <li>■ Confirmation tone</li> <li>■ Intercept tone</li> </ul>  | <p>Forwarding is successful.</p> <p>The extension is not valid.</p>   |
| 5. The digit 1 or 2 for the first or second coverage option  | <ul style="list-style-type: none"> <li>■ Confirmation tone</li> <li>■ Intercept tone</li> </ul>  | <p>The request is successful — the coverage option changed.</p> <p>The user did not enter 1 or 2.</p>   |

**Table 4-80. How to use Extended User Administration of Redirected Calls to deactivate Call Forwarding from an on-site location**

| User entry  | System response   | Explanation   |
|---|---|---|
| 1. The Extended Call Fwd Deactivation FAC                 | <ul style="list-style-type: none"> <li>■ Dial tone</li> <li>■ Intercept tone</li> </ul> | <p>The system is prompting for the extension.</p> <p>The user entered an FAC not defined in the system or not allowed for this user.</p>  |
| 2. Extension followed by #, or only a #                   | <ul style="list-style-type: none"> <li>■ No response</li> </ul>                         | <p>The single # refers to the extension at which the user is entering information.</p> <p>If the user is at a voice terminal with a display, the # is the last character that the user sees until the command sequence is complete, unless the station is a BRI station. If it is a BRI station, all characters are visible.</p>  |
| 3. SSC for the extension entered in step 2, followed by # | <ul style="list-style-type: none"> <li>■ Dial tone</li> <li>■ Intercept tone</li> </ul> | <p>Call Forwarding is cancelled.</p> <ul style="list-style-type: none"> <li>■ The user has requested an extension that does not allow extended forwarding in its COS.</li> <li>■ The user has entered an invalid or untranslated extension. This is logged as an invalid attempt.</li> <li>■ The user entered an extension that has an inaccessible tenant partition number for the tenant partition number of the dialing station.</li> <li>■ SSC is invalid for the extension. This is logged as an invalid attempt.</li> <li>■ Interdigit timeout has occurred.</li> </ul> |

### Using this feature from an attendant or console-permissions station

This operation is the same as that described for a user, except that console-permissions stations and attendants do not need to enter a station security code, nor do they need to press the pound key (#).



## How to use Extended User Administration of Redirected Calls FAC from an off-site location

To use Extended User Administration of Redirected Calls from off-site, a user must first access the telecommuting-access extension. If the user is making the request via DID, the user must precede the extension with the correct public-network prefix. If the user is making the request via a trunk group dedicated to remote access of this feature, the user must dial the public-network number for the trunk group.

The system provides dial tone after the user accesses the telecommuting access extension. At that point the user can enter only one of the four FACs associated with this feature. The four FACs associated with Extended User Administration of Redirected Calls are:

- Extended Call Fwd All Activate
- Extended Call Fwd Busy D/A Activate
- Extended Call Fwd Deactivation
- Change Coverage

When the system provides dial tone, the user can proceed with the steps outlined for on-site use of the feature in [Table 4-335](#).

## How to interrupt the command sequence

To interrupt the command sequence and begin again, the user can enter an asterisk (\*) at any point before the second pound sign. The system provides dial tone, and the user can begin the command sequence at the point of entering the user's extension. (The user should not enter the FAC again.) The interrupted command sequence is not recorded as an invalid attempt.

## Security

---

### SECURITY ALERT:

*Invalid extensions and invalid station security codes are logged as security violations. The extension or incoming trunk from which the command sequence was dialed, the FAC, and the dialed command string appear on the Monitor Security-Violations Station Security Codes screen or report if Security Violation Notification is enabled.*

To track security violations, see [“Security Violation Notification” on page 4-531](#) for administration information.

## Considerations

---

- The Station Status screen shows the station's active lead-coverage path (1 or 2).

## Interactions

---

- Administered without Hardware  
Extended User Administration of Redirected Calls is allowed for AWOH extensions.
- Bridged Appearance  
When the pound key (#) is pressed from a bridged appearance immediately following any of this feature's four FACs, the system assumes that the currently active bridged extension will be administered. The station security code of the currently active bridged extension must be entered after the initial # to successfully complete the command sequence.  
  
If the station has only bridged appearances, the station's extension must be dialed after the FAC to successfully complete the command sequence, since the station's extension is not associated with any appearances.
- Call Coverage  
Extended User Administration of Redirected Calls interacts with this feature only in that system users can change their lead-coverage path.  
  
An attempt to activate Send All Calls is denied if the currently active coverage path does not allow Send All Calls in its coverage criteria. However, if users activate Send All Calls when it is allowed, and then change their coverage path to one that does not allow Send All Calls, the Send All Calls button remains lit and Send All Calls automatically resumes if the user changes back to the coverage path that allows it.
- Call Forwarding  
When Call Forwarding is active, the status lamps for the active features for that extension are lit. When Call Forwarding is deactivated, the status lamps for both Call Forward All and Call Forward Busy/DA buttons for that extension are extinguished. Off-net forward destinations are not allowed.
- Distributed Communications System  
Assign a different telecommuting access extension for each switch. System users can use Extended User Administration of Redirected Calls from any of the DCS nodes, but they dial the extension of the node on which their station is defined before dialing the FAC.

**4 Basic Features**

*Extended User Administration of Redirected Calls*

*Page 4-339*

- **Security Violation Notification**

Extended User Administration of Redirected Calls security violations are tracked and reported by SVN for station security codes, if it is enabled.

- **Tenant Partitioning**

The telecommuting access extension is always automatically assigned to Tenant Partition 1, so that it can be accessed by all tenants.

The tenant number of the extension being administered must be accessible by the tenant number from which the Extended User Administration of Redirected Calls FAC is being dialed or the request is denied. If the FAC is being dialed on site, the tenant number of the station or attendant must have access to the tenant number of the extension being administered. If the FAC is being dialed off site, the tenant number of the incoming trunk must have access to the tenant number of the extension being administered.

## External Device Alarming

---

External Device Alarming allows you to assign analog ports to alarm interfaces for external devices. You can specify a port location, information to identify the external device, and the alarm level to report when a contact closure occurs.

You can designate the alarm condition for an external device as major, minor, or warning. External Device Alarming is supported on all analog-line circuit packs that are supported by DEFINITY ECS.

For more information, see *DEFINITY Enterprise Communications Server Release 6 Maintenance for R6r* or *DEFINITY Enterprise Communications Server Release 6 Maintenance for R6vs/si* or *DEFINITY Enterprise Communications Server Release 6 Maintenance for R6csi* for your system type.

### How to administer EDA

---

#### Required forms

---

| Form                                   | Field                         | Page                  |
|--|-------------------------------|-----------------------|
| System Parameters<br>Customer- Options | ■ External Device Alarm Admin | <a href="#">5-277</a> |
| External-Device-Alarm                  | ■ All                         | <a href="#">5-108</a> |

### Interactions

---

None

## Facility Busy Indication

---

Facility Busy Indication provides multiappearance voice-terminal users with a visual indication of the busy or idle status of one of the following system resources:

- An extension number
- A trunk group
- A terminating extension group
- A hunt group (either DDC or UCD)
- Any loudspeaker paging zone, including all zones

The Facility Busy Indication button provides the attendant or user with direct access to the extension number, trunk group, or paging zone.

You can store extension numbers, trunk group access codes, and Loudspeaker Paging access codes in a Facility Busy Indication button.

### How to administer Facility Busy Indication

---

#### Required forms

---

| Form                      | Field   | Page                 |
|---------------------------|---|----------------------|
| Station (multiappearance) | ■ Button/Feature Button Assignments<br>— busy-ind (TAC/Ext) | <a href="#">6-14</a> |
| Attendant Console         | ■ Feature Button Assignments<br>— busy-ind (TAC/Ext)        | <a href="#">5-35</a> |

---

### Detailed description

---

An attendant or a voice-terminal user can have one or more Facility Busy Indication buttons. The Facility Busy Indication buttons can be used in two ways:

- When users need to know the status of a resource, they press the appropriate Facility Busy Indication button. The system then automatically selects an idle call appearance and places a call to the resource. If the resource is idle, the lamp remains lit until you disconnect from the resource.
- If a user has not pressed the Facility Busy Indication button and the lamp lights, the resource is busy. If the lamp flashes, the resource is placing a call to the attendant or voice terminal who is tracking the resource. The attendant, and more than one voice terminal, can track the same resource.

An attendant can store extension numbers, trunk group access codes, and Loudspeaker Paging Access codes in a Facility Busy Indication button.

4 Basic Features

*Facility Busy Indication*

Page 4-342

The system updates the status of the tracked resource within five seconds of detecting the change.

The Facility Busy lamp indication for a VDN does not light when the VDN is being used. The associated button may be used to place a call to a VDN.

## Considerations

---

- It is possible that an incoming call that causes the lamp to flash may go unanswered. Here is the situation in which that can occur. If the lamp represents the status of a trunk group, and all trunks in the trunk group become busy before the flashing call is answered, the system lights the lamp steadily to indicate that all trunks are busy. When a trunk in that trunk group becomes idle, the system turns off the busy indication and the lamp goes dark. In this situation, the call has not been answered or dropped, even though the lamp flashed, lit steadily, and went out.
- A voice terminal user cannot use this feature to monitor the status of the attendant console.

## Interactions

---

None

## Facility Test Calls

---

You can place Facility Test Calls from a voice terminal to test specific trunks, DTMF receivers, time slots, and system tones. Lucent Technologies remote maintenance personnel can make test calls from remote locations. Four types of Facility Test Calls are available:

- Trunk — To test specific tie or CO trunks. You cannot test DID trunks with this feature. Your Class of Restriction (COR) must allow you to use the Facility Access Trunk Test option.
- DTMF receiver — To test the DTMF receivers located on a tone detector or call classifier/tone detection circuit pack.
- Time slot — To test a specific time slot on the time division multiplex buses or out-of-service time slots.
- System tone — To test a specific system tone.

*DEFINITY Enterprise Communications Server Release 5 Maintenance for R5vs/si, DEFINITY Enterprise Communications Server Release 5 Maintenance for R5r, and DEFINITY Enterprise Communications Server Console Operations* contain more information.

### How to administer Facility Test Calls

---

#### Required forms

| Form                      | Field  | Page                  |
|---------------------------|--|-----------------------|
| Feature Access Code (FAC) | ■ Facility Test Calls Access Code            | <a href="#">5-113</a> |
| Class of Restriction      | ■ Facility Access Trunk Test                 | <a href="#">5-72</a>  |
| Station (multiappearance) | ■ Feature Button Assignments<br>— trk-ac-alm | <a href="#">6-14</a>  |

### Security

---

Proper administration of Facility Test Calls minimizes the ability of unauthorized persons to gain access to the network. However, it is your responsibility to properly implement the feature, evaluate and administer the various restriction levels, protect access codes, and distribute the codes only to individuals who have been advised of the sensitive nature of the access information. Each authorized user should be instructed in the proper use and handling of access codes.

In rare instances, unauthorized individuals use Facility Test Calls to connect to the public switched network. Applicable tariffs require that the customer pay all network charges for such calls. Lucent Technologies, Inc., cannot be responsible

for charges incurred by such calls, and will not make any allowance or give any credit for charges that result from unauthorized access.

To help secure this feature from unauthorized use, take the following steps:

- Remove the access code when not in use.
- Change the access code from the factory default.
- Secure records of the access code.
- Use COR to restrict which users can use the access code.

You can set Logoff Notification to notify you at logoff if Facility Test Calls is still enabled. This notification guards against inadvertently leaving Facility Test Calls active. It can also alert the you to unauthorized feature activation.

Consult the *BCS Products Security Handbook* for additional steps to secure your system.

## Considerations

---

You must use a touch-tone phone that resides on the local switch to make test calls.

## Interactions

---

- Service Observing  
You cannot use Facility Test Calls for Service Observing.



## Flexible Billing

---

Flexible Billing allows DEFINITY ECS or an adjunct to communicate with the public network using ISDN PRI messages to change the billing rate for an incoming 900-type call. Rate-change requests to specify a new billing rate can be made anytime after a call is answered and before it disconnects.

Flexible Billing is available in the U.S. for use with AT&T MultiQuest<sup>®</sup> 900 Vari-A-Bill<sup>™</sup> Service. Flexible billing requires a CallVisor Adjunct-Switch Application Interface (ASAI) and customer-supplied application software.

### How to administer Flexible Billing

---

Display the System-Parameters Customer-Options form and ensure that Flexible Billing and ISDN-PRI are set to **y**.

### Detailed description

---

All change requests are initiated by an adjunct processor (CPE host or VRU) connected to the DEFINITY ECS. The customer-provided application on the adjunct processor tells the adjunct when to request a rate change. The billing rate can be changed to any of the following:

- New rate
- Flat rate (not dependent on length of call)
- Premium charge (a flat charge in addition to the existing rate)
- Premium credit (a flat negative charge in addition to the existing rate)
- Free call

There is never a negative charge for calls. During provisioning process, a maximum rate is set for each 900 number.

You might want to change the billing rate for a call in progress when you want:

- A new rate for valuable services such as requests for limited-access information, conversion of text mail to speech, or technical support.
- A flat rate for consultant support, warranty registration, maintenance contracts, or recovery of a fixed-cost service or product.
- A premium charge for callers who need specialized delivery of information such as overnight mail or FAX, or to recover the cost of a sample product, account summary, or transcript.
- A premium credit applied for promotional discounts, first-time callers, contest winners, or those who use low-overhead resources such as electronic media rather than human agents.

Flexible Billing operates as follows:

- An incoming PRI call from the network contains a message that a call can or cannot use the AT&T MultiQuest 900 Vari-A-Bill Service.
- This information is passed to the adjunct processor using ASAI messaging or to the PRI VRU adjunct.
- The adjunct is informed of the Flexible Billing capability of a call only if the called VDN, split, or agent is included in a monitored domain for which notification has been requested by that adjunct processor.
- Success and failure results from the request are returned to the adjunct.

Subsequent change requests can be made for a call that has already had a rate change. In this case:

- If the original and subsequent requests were flat charge or new rate, the previous change is overwritten.
- If the original request was premium charge or premium credit, the subsequent request must be either premium charge or premium credit.

In any case, the new rate is effective from the time the original change took effect.

The system can handle a limited number of change requests. See the *DEFINITY Enterprise Communications Server System Description Pocket Reference* for capacities information.

## Considerations

---

Cellular end offices and some other end offices (NPA-NXX) do not have the necessary billing software to accept rate changes. If you receive a large percentage of calls from specific exchanges, geographical areas, or cellular callers, do a careful analysis before using Flexible Billing.

Before changing the caller rate, you must inform callers of the new rate and get their agreement.

## Interactions

---

- Call Detail Recording  
If the User Data item is being recorded, the count for this item increases when you use Flexible Billing.
- Call Vectoring  
Incoming Flexible Billing calls can use Call Vectoring for routing.  
If a VDN Return Destination is assigned and Flexible Billing is active for a call, the return destination is ignored and the call disconnects.

- Conference

If a call arriving on a trunk that supports Flexible Billing is conferenced with a call from a trunk that does not support Flexible Billing, the switch sends billing change requests to the trunk that supports Flexible Billing. If calls are conferenced from trunks that both support Flexible Billing, only one trunk is sent billing change requests.



**NOTE:**

Do not conference calls from two or more incoming Flexible Billing trunks.

- Transfer

If a call is answered by a party on the local switch and is transferred to a second switch, the second switch does not receive an indication that the call has Flexible Billing. However, Flexible Billing is available when a call is transferred to another monitored domain on the same switch.

## Go to Cover

---

Go to Cover allows users who call another internal extension to send the call directly to coverage.

### NOTE:

Go to Cover cannot be activated for calls placed to a Vector Directory Number extension. Go to Cover can be used to force a call to cover to a VDN if the called principal has a VDN as a coverage point.

Go to Cover can be used only if the called party is assigned a call-coverage path. The called party must have alternate answering positions assigned.

To activate Go to Cover, press the Go to Cover button after the call is ringing. Intercom — Automatic, Intercom — Dial, and Priority Calling redirect to coverage when the caller presses the Go to Cover button.

## How to administer Go To Cover

---

### Required forms

---

| Form                       | Field   | Page                 |
|----------------------------|---|----------------------|
| Station (multi-appearance) | ■ Button/Feature Button Assignments -goto-cover | <a href="#">6-14</a> |

---

## Group Listen

---

Group Listen allows voice terminal users to talk and listen to another party with the handset or headset while the 2-way speakerphone is in the listen-only mode. Others in the room can listen, but cannot speak to the other party via the speakerphone. The person talking on the handset acts as the spokesperson for the group. Group Listen provides reduced background noise and improves clarity during a conference call when a group needs to discuss what is being communicated to another party.

### How to administer Group Listen

---

1. On the first page of the 6400 Station form, enter **grp listen** in the *Speakerphone* field.
2. Submit the change.

### Detailed description

---

Group Listen works with 6408+, 6408D+, 6216D+, and 6424D+ voice terminals. To activate Group Listen, the user picks up the handset, places the call, and while actively talking/listening, presses the speaker button. Users with a headset plugged into their terminal (and a handset on-hook) activate Group Listen the same way. The headset is then in the talk/listen mode and the speakerphone is in the listen-only mode.

**Table 4-81. User interactions with Group Listen**

| Action while in Group Listen                               | Result  |
|--|---|
| Press speaker button while using a headset or handset only | Speakerphone is turned off and handset or headset remains in talk/listen mode |
| Hang up handset before 10 seconds pass                     | Call remains active and speakerphone goes into talk/listen mode               |
| Hang up handset after 10 seconds                           | Call terminates and speakerphone is turned off                                |
| Press Drop button anytime                                  | Call terminates, handset and speakerphone hear dialtone                       |
| Plug in headset when handset is active                     | Ignored   |

---

*Continued on next page*

**Table 4-81. User interactions with Group Listen — Continued**

| Action while in Group Listen            | Result  |
|---|---|
| Unplug headset while handset is active  | Ignored   |
| Unplug headset while handset is on-hook | Group Listen is deactivated and speakerphone goes into talk/listen mode |
| Off-hook alerting messages              | Ignored   |

See *6400-Series Single-Line Telephone User's Guide* (555-230-738) and *6400-Series Multi-Line Telephone User's Guide* (555-230-739) for more information about user interactions.

### To transition from Group Listen to 2-way speakerphone

- For Handset

If users are active on a call in Group Listen with the handset off-hook, and, after 10 seconds want to use the speakerphone for 2-way communication without dropping the call, they:

1. Press the speaker button, causing the handset to be in talk/listen mode and the speakerphone disabled
2. Press the Speaker button, causing Group Listen to activate
3. Within 10 seconds, hang up the handset, causing the handset to deactivate and the speakerphone to be 2-way

- For Headset

If users are active on a call in Group Listen with the handset on-hook, and, after 10 seconds want to use the speakerphone for 2-way communication without dropping the call, they:

1. Press the Speaker button, causing the headset to be in talk/listen mode and the speakerphone disabled
2. Press the Speaker button, causing Group Listen to activate
3. Within 10 seconds, press the Headset button, causing the headset to deactivate and the speakerphone to be 2-way

## Considerations

---



### **SECURITY ALERT:**

*To avoid legal issues in some states or countries, Group Listen users should alert the other party when others are listening to a conversation.*

## Interactions

---

- Conference/ Transfer/Hold

If the user pushes the Conference, Transfer or Hold button while in Group Listen mode, the group that is listening hears what the handset user is hearing.

## Group Paging

---

Group Paging allows a user to make announcements to groups of stations. The announcements are broadcast and they automatically turn on a station's speakerphone. This feature is especially useful when real-time announcements need to be made to several members of a group. A user dials a paging extension and the speakerphones of all idle members of a group are activated with a listen-only capability. The user delivers a message to the group and the group members hear the message. Group members cannot respond to the user during a page.

### How to administer Group Paging

---

1. At the system administration terminal (SAT), enter **add group-page x** (where **x** is the number of the page group to be added).  
You receive the form, Group Paging Using Speakerphone.
2. In the `Group Extension` field, enter the extension to be dialed when using the page group.
3. In the `Group Name` field, enter the name that the display will show when calling the page group.
4. In the `COR` field, enter the class of restriction.
5. Submit your changes.

Paging can now be used. If you wish to view all or some of the page groups, at the SAT, enter **list group-page**.

The maximum number of paging groups in a system is 32 and the maximum number of members allowed in a paging group is 32.



#### NOTE:

You can administer a group paging button to any DCP terminal. The `Number` field represents the extension of the page group, not the group paging number (1 - 32). You can enter the entire group paging extension or assign a range of extensions that relate to a group paging extension. For example, extensions 4001 - 4032 are group page extensions for groups 1 - 32. You can enter 40 in the `Number:` field so that you only need to recall the last two representative digits of the page group (01, 02, 03, etc.).



## Detailed description

---

You use a new form, Group Paging Using Speakerphone, to administer a paging group. You can add a station to multiple paging groups.

An extension in a paging group does not hear the announcement if the paging group member:

- Is active on an appearance and using the speakerphone
- Is active on an appearance and using the handset
- Has a ringing call appearance
- Is using Send All Calls
- Is using Do Not Disturb
- Is off-hook

### NOTE:

When a group member does not hear the announcement for any of these reasons, the caller is not notified. Therefore, if it is important for everyone to hear your announcement, you should check with the people in the group to make sure that they received it. If none of the group members hear the announcement for any of these reasons, the caller receives a busy signal.

The people being paged can only listen to the page over the speakerphone or handset and cannot respond to the person making the page. A paging group member can drop the call by disconnecting.

The ability to initiate a group page is restricted on a per-station basis via the COR feature. All DEFINITY features that use the COR are subject to this restriction. This includes, but is not limited to: trunks, digital stations, analog stations, and BRI stations. Any station that wishes to initiate a page group must have permission to call the COR of the page group. Otherwise, the ability to page that group is denied.

Pages can be made to the following phones with speaker capability: 6400-series, 7406D, 7406+, 7407D, 7407+, 7410+, 7444, 8403B, 8405B/B+, 8405D/D+, 8410B, 8410D, 8411B, 8411D, and 8434D.

### NOTE:

See *6400-Series Single-Line Telephone User's Guide* (555-230-738) and *6400-Series Multi-Line Telephone User's Guide* (555-230-739) for more information about user interactions.

## Considerations

---

### Security Considerations

Because of the nature of this feature, use caution when disseminating sensitive information. The page initiator is responsible for the range of people who could inadvertently listen to the page on a neighboring phone.

Enter class of restrictions (CORs) on the VDN and Trunk Group forms as needed for your protection. This enables/disables VDNs and trunk groups from making page calls.

### Interactions

---

- Attendant Intrusion

The attendant cannot intrude onto an ongoing group page call. If the attendant attempts to intrude onto a page group, the attendant receives intercept tone. If the attendant tries to intrude onto the paging originator, the intrusion attempt succeeds. However, all group page members are able to hear both the paging originator and the attendant.

- Auto Exclusion and Manual Exclusion

Bridged appearances are not allowed on the page. Therefore, the Auto Exclusion and Manual Exclusion features are disabled. If the manual exclusion button is pressed, it is ignored. Auto Exclusion does not activate because there are no bridged appearances alerted when the page terminates.

- Auto Hold

Auto Hold does not put a group page call on hold. The group page call is dropped and the incoming call is answered.

- Automatic Callback

Automatic Callback is disabled when calling an active page group. Auto Callback functions normally when calling a single member of the page group or the page originator. Automatic Callback functions normally when a page member activates Auto Callback and subsequently receives a group page call. The origination of a page results in either a successful page or a busy signal. If the page originator presses the automatic callback button when calling a busy page group, reorder tone is received.

Automatic Callback functions normally if the target extension is a single member of the page group or the page originator. If the target extension is a member of the page group, when the page is disconnected from that particular station, the callback works normally.

- Bridging

Bridging is disabled on this feature. A bridged appearance of a group member does not receive any indication of a call when the page arrives. The bridged appearance cannot bridge onto the page. If the bridged appearance attempts to bridge onto the page, intercept tone is received.
- Call Coverage

A page call does not follow a coverage path on a paged member. A page group cannot be a coverage point. The group page does not go to coverage if the group member is not there. For that group member, the page either terminates at the station or does not terminate at all.
- Call Park

Group members who receive a page cannot park the call. If the call park button is pressed by a page group member while listening to a page, the button press is ignored and the page continues normally.
- Call Pickup/Direct Call Pickup

Group pages cannot be picked up by other extensions. Another extension cannot pick up a group page. The group page either terminates at the target extension or does not terminate at all. Any other station does not have the opportunity to perform Call Pickup.
- Call Forwarding

The group page cannot be call forwarded. A page call does not follow a page group member's call forward path. No station including the attendant can set the group page to be forwarded to another number. If a page call terminates to a station with call forwarding active, the page does not follow the call forwarding path. The page terminates at the station as in the normal page case.
- Conference

Group members who receive the page and the originator of the page cannot conference the page to other extensions. Group members are prevented from putting the page on hold.
- Distributed Communications System (DCS)

Page groups cannot be administered across DCS switches. DCS is not supported.
- Direct Inward Dialing

Direct Inward Dialing works normally, but can be restricted from originating group pages by changing the COR.
- Go to Cover

The Go to Cover feature is disabled. Page originators cannot send a page call to cover. The page call does not have a coverage path to follow. If the page originator presses the go to cover button, the button press is ignored.

- Hold

Group members cannot put a group page on hold. The originator can put the group page on hold. If a page group member attempts to put the page on hold, the button press is ignored and the page continues normally. The group member pressing the button receives broken flutter on the call appearance lights.
- Leave Word Calling

The Leave Word Calling (LWC) feature is disabled. A page group cannot receive messages. If the LWC calling button is pressed when calling a busy page group, intercept tone is received.
- Manual Signaling

The Manual Signaling feature cannot be assigned to a page group.
- Send All Calls

If a page group member activates Send All Calls (SAC), that member does not receive pages.
- Service Observing

A group page member or originator cannot be service observed while active on a page. If a service observer tries to activate Service Observing on a party involved on an ongoing page, intercept tone is received.
- Tenant Partitioning

Tenant Partitioning is unaffected. The page group extension is forced into tenant partition 1. Regardless of the partition in which the page group members are located, the COR restrictions always apply.
- Transfer

Group members cannot transfer the page. A station can transfer another extension to a group page number. Once a group page originator is active on a page call, they can't transfer the page group to another extension.
- Trunks

Trunks cannot be a page group member. If the user attempts to add a trunk to a page group, they are denied access with the standard error message. Trunks may initiate pages if COR permissions allow for this. Trunk access can be restricted by the COR.

- Vectoring

Paging groups cannot be explicitly added to a vector path. If a user attempts to add a page group to a vector path, they are denied access and receive the error message “Cannot route to a group page group.”



**NOTE:**

If a vector has a collect digits step and a route-to digits step, a person who uses the vector can enter a page group extension. Ensure that the COR of the vector restricts the vector from calling the page group if this action is not desired.

## Hold

---

Hold allows voice-terminal users to disconnect from a call temporarily, use the voice-terminal for other call purposes, and then return to the original call.

### How to administer Hold

---

#### Required Forms

---

| Form                      | Field   | Page                  |
|---------------------------|---|-----------------------|
| Feature Access Code (FAC) | ■ Answer Hold-Unhold                          | <a href="#">5-113</a> |
| Station                   | ■ Button/Feature Button Assignments<br>— hold | <a href="#">6-28</a>  |

---

### Detailed description

---

#### Multiappearance Voice-terminal Hold

Multiappearance voice-terminals have a Hold button for activating Hold.

To hold an active call, press the Hold button. The call is held at the call appearance used for the call. Multiappearance voice-terminal users can hold a call on each call appearance.

#### Single-Line Voice-terminal Hold

Two types of Hold (Soft Hold and Hard Hold) are provided for single-line voice-terminal users.

##### Soft Hold

Soft Hold is used to conference or transfer a call that includes the held call. The user can hold the current call, consult with another party, activate or deactivate a feature, and return to the soft-held call.

- To activate Soft Hold:
  1. Press the Recall button or flash the switchhook while on an active call.
- To conference a call:
  1. Activate Soft Hold.
  2. Dial another party.
  3. Press the Recall button or flash the switchhook a second time.

The held call is conferenced with the user and the other party.

- To transfer a call:

1. Complete a conference call.
2. Hang up.

The held call is conferenced with the other party. The system ignores any subsequent presses of the Recall button or flashing of the switchhook.

- To drop the last party added to a conference call:

1. Complete a conference call.
2. Press the Recall button or flash the switchhook.

This function can be performed only by the controller of the conference call.

## Hard Hold

Hard Hold is used to perform operations that do not include the held call. The user can hold the current call, then call another party, answer a waiting call and transfer or conference that call, activate or deactivate features, and so on.

- To activate Hard Hold

1. Press the Recall button or flash the switchhook while on an active call.
2. Dial the Answer Hold-Unhold access code.

The user can then perform any operation that does not involve the held call.

- To return to the hard-held call:

1. Hang up.

The held call rings the voice-terminal and can then be answered.

or

1. Press the Recall button or flash the switchhook.
2. Dial the Answer Hold-Unhold access code.

The active call is held while the hard-held call becomes active.

### NOTE:

When a user has a call waiting and activates Hard Hold on a current call, an incoming call is answered automatically.

## Considerations

---

- Use Hold to temporarily disconnect from one call and handle another call. For example, a user can place one call on hold and either answer another call or make another call to obtain information for the calling party.
- To drop a call dialed by a single-line voice-terminal within the first 10 seconds (after dialing is completed), flash the switchhook.
- A single-line voice-terminal user cannot hold a call involving an attendant. A multiappearance voice-terminal user can hold a call involving an attendant, unless the user attempts to conference or transfer the call.

## Interactions

---

- Automatic Callback  
A single-line voice-terminal user cannot receive an Automatic Callback call while a call is on hold.
- Bridged Call Appearance  
Any user who is active on a bridged call, can place the call on hold. If no other users with a bridged call appearance of the same extension are connected to the call, the status lamp at the Bridged Appearance button indicates that the call is on hold. If the primary extension or another bridged appearance is connected to the call, the status lamp at all bridged appearances indicates an active status for the call.
- Leave Word Calling (LWC)  
A held multiappearance voice-terminal user can activate LWC toward the holding user.  
A single-line voice-terminal user cannot activate LWC toward another user while a call is on Soft Hold.
- Music-on-Hold  
One party on hold can hear music.
- Personal Central-Office Line (PCOL)  
When a user who is active on a PCOL call puts the call on Hold, the lamp flutters or winks. The status lamp associated with the PCOL button lamp does not track the busy/idle status of the PCOL.
- Priority Calling  
It is possible to receive priority ringing and have a call on soft hold.



## Hold — Automatic

---

Automatic Hold allows attendants and multifunction voice-terminal users to alternate between multiple calls.

### How to administer Automatic Hold

---

#### Required forms

---

| Form                              | Field       | Page                  |
|-----------------------------------|-------------|-----------------------|
| Feature-Related System Parameters | ■ Auto Hold | <a href="#">5-123</a> |

### Detailed description

---

To put an active call on hold (without pressing the HOLD button), press a second call-appearance button. The second call appearance becomes active.

Automatic Hold is the equivalent of pressing the HOLD button. A call placed in Automatic Hold is in Hard Hold.

If Automatic Hold is disabled (the default), the active call appearance drops when a second call-appearance button is pushed. Default (n) in the `Auto Hold` field enables Automatic Drop.

Automatic Hold is enabled and disabled on a system-wide basis. The user of a multibutton voice-terminal may place on Automatic Hold as many calls as the number of call-appearances minus one.

The controlling station can have only one soft auto-held call at a time. A soft hold is the state of a line after the conference or transfer button has been pressed but before either process is completed. The controlling station is guaranteed the ability to reenter any auto-held call later unless the auto-held party or parties disconnect or the auto-held tone times out.

### Considerations

---

- Automatic Hold prevents dropping of active calls.
- When Automatic Hold is enabled and there is a call on active-call appearance, if the user selects an inactive call-appearance the active call is put on hard hold. This is the same as when the multifunction voice-terminal user presses the HOLD button and selects a call appearance. When Automatic Hold is disabled and there is an active call, if the user selects an inactive call appearance, the active call is dropped.
- When only Automatic Hold is involved and the attendant on an active loop presses a second loop, the active call is placed in Hard-Hold.

## 4 Basic Features

### Hold — Automatic

Page 4-362

- Held Call Timed Reminder does not apply to conference calls and is not initiated when a conference is placed on hold.
- Automatic Hold operates in conjunction with the START key or Automatic Start feature of an attendant console. The START key and the Automatic Start operation have precedence over Automatic Hold and place active loop call on Soft Hold.

## Interactions

---

- Centralized Attendant Service  
Automatic Hold operates transparently with CAS.
- Distributed Communications System  
Automatic Hold operates transparently with DCS and is administered separately for each node in a DCS network.
- Hold  
Automatic Hold operates identically to the Hold feature and its interactions. See [“Hold” on page 4-358](#) for details.

## Hot Line Service

---

Hot Line Service allows single-line voice terminal users, by simply lifting the handset, to automatically place a call to a preassigned destination (extension, public or private network telephone number, or feature access code).

### How to administer Hot Line Service

---

#### Required forms

| Form                            | Field                                       | Page                  |
|---------------------------------|---|-----------------------|
| Station (single-line)           | ■ Hot Line Destination Number and Dial Code | <a href="#">6-28</a>  |
| Abbreviated Dialing             | ■ Dial Code (hot line destination)          |                       |
| — 7103A List                    |   | <a href="#">5-14</a>  |
| — System List                   |   | <a href="#">5-11</a>  |
| — Group List                    |   | <a href="#">5-5</a>   |
| — Personal List                 |   | <a href="#">5-8</a>   |
| — Enhanced List                 |   | <a href="#">5-2</a>   |
| Data Modules                    | ■ Special Dialing Option                    | <a href="#">6-226</a> |
| — Data Line Data Module         | ■ Hot Line Destination AD List              | <a href="#">6-234</a> |
| MPDM/MTDM                       |   | <a href="#">6-243</a> |
| Netcon Data Module              |   | <a href="#">6-245</a> |
| Processor Interface Data Module |   | <a href="#">6-246</a> |
| — System Port Data Module (SAP) |   | <a href="#">6-248</a> |
| — Packet Gateway (PGATE)        |   | <a href="#">5-246</a> |
| — Netcon Data Module            |   | <a href="#">6-245</a> |

### Detailed description

---

The Hot Line Service destination number is stored in an Abbreviated Dialing List. When the Hot Line Service user lifts the handset, the system automatically routes the call to the stored number and the call completes as if it had been manually dialed. If the appropriate feature access code is prefixed to the stored number,

AAR, ARS, Data Privacy, or Priority Calling can be used on the call. If the Public or Private Network Access code is the stored number, the voice-terminal user is connected to an outgoing trunk and can dial the outside number.

Call reception is not affected by Hot Line Service. A Hot Line Service voice terminal receives calls allowed by its Class of Restriction (COR). The Hot Line Service destination is not affected by Hot Line Service.

A Direct Department Calling (DDC), a Uniform Call Distribution (UCD), a Terminating Extension Group (TEG) extension, or any individual extension within a group can be a Hot Line Service destination. Also, any extension within a DDC group, UDC group, or TEG can have Hot Line Service assigned.

## Considerations

---

- Use Hot Line Service when very fast service is required and when you use a voice terminal only for accessing a certain facility.
- Any number of voice terminals can be assigned Hot Line Service with the same or different destinations. The limitation is the number of entries that can be stored in the Abbreviated Dialing lists.
- A Hot Line Service user cannot activate any feature unless the access code is the destination number or is part of the destination number.

## Interactions

---

- Bridged Call Appearance — Single-Line Voice Terminal  
If a single-line voice terminal is administered for Hot Line Service, a bridged appearance extension also places a hot line call automatically when a user goes off-hook on that bridged appearance.
- Loudspeaker Paging Access  
Loudspeaker Paging Access can be used with Hot Line Service to provide automatic access to paging equipment.
- Ringback Queuing  
If a Hot Line Service call accesses a trunk group with Ringback Queuing, the call can queue unless the voice terminal is Termination Restricted by its COR. Queuing, when applicable, is automatic on single-line voice terminals. Dialing is not required.

## Hunt Groups

---

A hunt group is a group of extensions that can handle multiple calls simultaneously to a single phone number. For each call to the phone number, the system hunts for an available extension in the group and connects the call to that extension.

A hunt group is especially useful when you expect a high number of calls to a particular phone number. A hunt group might consist of people trained to handle calls on specific topics. For example, the group might be:

- A benefits department within your company
- A service department for products you sell
- A travel reservations service
- A pool of attendants

In addition, a hunt group might consist of a group of shared telecommunications facilities. For example, the group might be:

- A modem pool
- A group of data-line circuit ports
- A group of data modules



**NOTE:**

You may also assign Automatic Call Distribution (ACD) to a hunt group. In this case, the hunt group is known as an ACD split. See [“Automatic Call Distribution” on page 9-25](#) for more details about ACD splits.

### How to administer Hunt Groups

---

**Required forms**

| Form                            | Field                                | Page                  |
|---------------------------------|--------------------------------------|-----------------------|
| Announcements/<br>Audio Sources | ■ As required                        | <a href="#">5-26</a>  |
| Announcement Data<br>Module     | ■ All                                | <a href="#">6-233</a> |
| Coverage Paths                  | ■ All                                | <a href="#">5-94</a>  |
| Hunt Group                      | ■ All                                | <a href="#">5-158</a> |
| Trunk Groups (All)              | ■ Incoming Destination Night Service | <a href="#">7-115</a> |

## Detailed description

---

The following sections describe how a hunt group works.

### Hunting methods

The system uses one of two types of hunting method to distribute calls:

|                           |   |
|---------------------------|---|
| Direct department calling | The system hunts for an available extension in the hunt group, always starting with the first extension in the group. If the first extension is busy, the system checks the second extension. If the second extension is busy, the system checks the third, and so on. When an extension is available, the system rings that extension to connect the call. |
| Uniform call distribution | The system hunts for the extension that has been available for the longest time. The system then rings that extension to connect the call. This type of hunting provides the most equitable distribution of calls. <i>Also, this type of hunting is required for a modem pool, data-line circuit ports, and data modules.</i>                               |

#### NOTE:

With Expert Agent Selection, the hunting method is different. See [“Expert Agent Selection” on page 9-72](#).

### Hunt group queues

You can set up a queue for a hunt group. When all extensions in the group are busy, calls wait in queue for the next available extension. You determine how many calls can wait in queue by setting the queue length.

If all hunt-group members are unavailable or the queue is full, the system treats the call as follows:

- If the call is internal or is carried on a DID, DS1, or tie trunk, the caller hears busy tone.
- If the call is on a central office trunk, the caller hears ringing, but gets no answer.
- If the hunt group has call coverage, the system sends the call to a coverage point.

See [“How hunt group extensions become unavailable” on page 4-368](#).

## Queue warning level

You can set up a queue warning level and an associated queue warning indicator lamp. When the queue reaches this level, the lamp lights and remains lit until the queue drops below this level. You can have one lamp for each hunt-group queue. Install the lamp the hunt group can see it.

## Call coverage

You can set up call coverage for a hunt group. Then, if a hunt-group queue is full, the system sends new calls to the coverage point.

If a call goes into a hunt group queue, it stays in queue for the Coverage Don't Answer interval, then redirects to the coverage point. A call coverage point can be another hunt group.

## Announcements

You can record and assign one delay announcement to each hunt-group queue. An announcement can be shared among hunt groups. Normally, the announcement should tell the caller to wait and say that the call will be answered in the order in which it was received.

A call that connects to a delay announcement remains in queue while the announcement plays. If the call has not been answered by the time the announcement completes, the caller hears music (if provided) or silence. When the call begins ringing a member of the hunt group, the caller hears ringing.

**Delay announcement interval.** You also define for each hunt group a delay announcement interval. When a call enters the queue, the interval starts. This interval (0 to 99 seconds) indicates how long a call remains in queue before the call connects to a recorded announcement. If Call Coverage is provided, the Don't Answer interval (one to 99 ringing cycles) may also begin when the call enters the queue. After these intervals begin, one of the following occurs:

- If the Don't Answer interval expires before the delay announcement interval expires, the call redirects to coverage.
- If no coverage point is available to handle the call, the call remains in queue and may connect to the delay announcement.
- If the delay announcement interval expires before the Don't Answer interval, the call connects to a delay announcement. If the announcement is already in use, the delay announcement interval is reset.

This process continues until the call is answered, goes to coverage, connects to an announcement, or ends because the caller hangs up.

If you set the delay announcement interval to 0 seconds, a call automatically connects to the announcement. The result is a "forced first announcement." In this case, the call does not connect to a hunt-group member until after the announcement. The caller does not hear music.

If a call redirects to another hunt group via Call Coverage, the caller does not hear either hunt group's forced first announcement. However, the caller may hear the first or second announcement of the covering hunt group.

**Analog, aux-trunk, or integrated announcements.** Delay announcements may be analog, aux-trunk, or integrated (digital). For an analog or aux-trunk announcement, callers who enter the queue hear the associated announcement the next time the system plays it. Callers who enter the queue after the announcement begins do not hear it until it starts again. For an integrated announcement, multiple callers can be connected to the same announcement at different times, depending on the availability of ports. See ["Recorded Announcement" on page 4-500](#) for more information.

### Example

Assume that a hunt group has the following parameters.

- Queue length is 10 calls.
- Queue warning level is 5 calls.
- Recorded announcement delay is 20 seconds.

All hunt-group members are busy. A call enters the queue as the fifth call, which causes the queue warning level lamp to light. Hunt-group members see the lamp and try to quickly complete their present calls. Meanwhile, the call waits in the queue for 20 seconds and hears the recorded announcement. When a hunt-group member becomes available, the first call in queue connects to that group member. The queue warning-level lamp turns off because the number of calls in queue fell to four.

## How hunt group extensions become unavailable

An extension in a hunt group becomes unavailable to receive calls if the hunt group member is already handling a call. This rule is true even if the call is not a hunt-group call and even if the extension's voice terminal is a multiappearance terminal.

An extension also becomes unavailable if the member presses one of the following buttons:

- Hunt Group Busy
- Send All Calls
- Call Forwarding All Calls

### NOTE:

If a member is also an ACD agent, pressing the AUX work button also makes the member unavailable. On the other hand, if an agent presses the ACW (after call work) button, the system considers the agent be available and will still queue calls.



## Hunt Group Busy

If you turn on the Hunt Group Busy option, a hunt group member can dial the Hunt Group Busy code followed by the hunt group number. The extension is unavailable for calls until the group member dials the Hunt Group Busy cancellation code or presses the button again.

If the last available member of a hunt group tries to activate the Hunt Group Busy option, the following occurs:

- New calls to the hunt group receive busy tone or go to coverage.
- Calls already in the queue continue to route to the last available extension.
- When the queue is empty, Hunt Group Busy is activated. At the last available extension, the status lamp associated with the Auxiliary Work button, if provided, flashes until the queue is empty. When no more calls remain in the queue, Hunt Group Busy is activated and the status lamp, if provided, lights steadily.

### NOTE:

If an extension is an ACD split agent as well as a hunt-group member, the split agent normally has an AUX-work button that also activates/deactivates Hunt Group Busy. If an agent is the last available member and he/she pushes AUX-work, the button's light flashes until the queue is empty. This means that the agent is still available. When the queue finally empties, the button lights steadily and Hunt Group Busy takes effect.

## Send All Calls

Normally, if a hunt-group member presses the Send All Calls button, the system still sends calls to that member, but the calls go to coverage. Therefore, members should not normally use Send All Calls to become unavailable.

### NOTE:

If an extension is an ACD split agent as well as a hunt-group member, the split agent normally has an AUX-work button that also activates/deactivates Hunt Group Busy. If an agent presses the Send All Calls button, the agent becomes unavailable for hunt-group calls. The agent can then become available for calls again by pressing the Send All Calls button again.

## Call Forwarding All Calls

With Call Forwarding All Calls active, an extension within a hunt group is unavailable for hunt-group calls. Callers hear the hunt group's forced first announcement, if administered, before the system forwards the call.

## Considerations

---

- Members assigned to multiple hunt groups

An extension can be a member of more than one hunt-group. However, a voice terminal, even a multiappearance terminal, can receive only one hunt group call at a time. On a multiappearance terminal, all appearances must be idle to receive a hunt-group call.

You can assign a Coverage Incoming Call Indicator (ICI) button to a multiappearance voice terminal or attendant console. When a member receives a call for the hunt group associated with the ICI button, the button's status lamp lights.
- ACD agents as hunt group members

Do not include ACD split agents in non-ACD hunt groups if they also receive ACD split calls. The system distributes all ACD calls to split agents before it distributes hunt-group calls.

When you change an ACD split to a non-ACD hunt group, each split agent must enter the Hunt Group Busy deactivation code in order to receive calls in that hunt group. If the agent has an AUX-work button, the button lamp lights when you make the change. The agent can then press the button to become available for hunt-group calls.
- Hunt group for communications devices

Members of a hunt group used for shared data communications must be of the same type. Thus, you can put data modules or analog modems in a hunt group, but not both. Option settings must be the same for all group members.

A caller can still use the Data Extension button to access the associated data module, even if the module is in a hunt group. Individual data modules or modems can originate and receive calls.
- Access restrictions

You can restrict, via the Class of Restrictions, any extension in a hunt group from receiving calls other than those to its assigned hunt group. You can also restrict extensions on your switch from calling the hunt group's extension.
- System limits

The size of your system determines how many hunt groups you can set up and how many extensions you can assign to each group.
- Trunk signaling

A hunt group always has its own extension. Therefore, a caller with a phone on the switch can call the hunt group by dialing only that extension. If a trunk group has the ability to pass digits from the CO to the switch (for

example, a DS1 trunk group with immediate signaling), a caller can also call the hunt group by dialing a 7-digit phone number that consists of a specified prefix and the hunt group's extension.

If a trunk group cannot pass digits from the CO to the switch, incoming calls on that trunk group can connect to a hunt group only if the trunk group has the hunt-group extension as its primary destination. This includes trunk groups for incoming LDN calls, international exchange calls, 800 service calls, and automatic tie-trunk calls. The hunt group's phone number can be completely different from the hunt group's extension.

- Answer supervision

The switch sends answer supervision to the central office when a call connects to an extension in the hunt group or an announcement. Charging for the call, if applicable, then begins.

## Interactions

- Attendant Call Waiting

Attendant Call Waiting does not work for calls that the attendant sends to a hunt group. It does work for calls to individual hunt-group members.

- Attendant Return Call

Attendant Return Call does not work for calls that the attendant sends to a hunt group.

- Automatic Callback

Automatic Callback does not work on calls to a hunt group.

- Call Detail Recording

For each call, the system can record the associated hunt-group extension or member extension that answered.

- Internal Automatic Answer

Internal calls to a hunt-group member are eligible for IAA.

- Leave Word Calling

A hunt group can receive and store LWC messages. The following people can retrieve LWC messages:

- One member of the hunt group
- A covering user of the group
- A system-wide message retriever

The message retriever must have a voice-terminal display and proper authorization. If the message retriever is a member of the hunt group, you can assign to that member a remote Automatic Message Waiting lamp to indicate when the hunt group has an LWC message.

- Night Service — Hunt Group

When Night Service is active for a hunt group and the night service destination is another hunt group, the caller hears the forced announcement of the first hunt group, if administered. The system then redirects the call to the night-service hunt group.

- Priority Calling

The system treats a priority call to a hunt group the same as a nonpriority call, except that the extension receives a distinctive 3-burst ring.

- Terminating Extension Group

A Terminating Extension Group cannot be a member of a hunt group.

## Incoming Call Line Identification on Analog Trunks

Incoming Call Line Identification (ICLID) provides you with the calling party name and number received from the central office (CO). This occurs on a CO loop-start trunk in the U.S. and on a CO loop-start, DID, or DIOD trunk in Japan.

### How to administer ICLID

#### Required forms

| Form                                  | Field                             | Page                  |
|---------------------------------------|-----------------------------------|-----------------------|
| System-Parameters<br>Customer-Options | ■ G3 Version                      | <a href="#">5-277</a> |
|                                       | ■ Analog Trunk Incoming Call ID   |                       |
| Trunk Group                           | ■ Country                         | <a href="#">7-115</a> |
|                                       | ■ Group Type                      |                       |
|                                       | ■ Answer Supervision Timeout      |                       |
|                                       | ■ Receive Analog Incoming Call ID |                       |
| Administrable Timer                   | ■ Incoming Seizure (msec)         | <a href="#">7-115</a> |

On System-Parameters Customer-Options form, set

- G3 Version field to **V6** or greater.
- Analog Trunk Incoming Call ID field to **y**.

On Trunk Group form, set

- Group Type field to **co**, **did**, or **diod**.
- Receive Analog Incoming Call ID field to **Bellcore** (for U.S.) or **NTT** (for Japan).
- Direction field is **incoming** or **two-way**.

On Administrable Timer form, set

- Incoming Seizure (msec) to **120**.

To turn off ICLID, set

- Receive Analog Incoming Call ID field on System-Parameters Customer-Options form to **disable**.
- Analog Trunk Incoming Call ID on Trunk Group form to **n**.

## 4 Basic Features

### Incoming Call Line Identification on Analog Trunks

Page 4-374

## Hardware requirement

TN429D CO Trunk circuit pack or later configuration

## Detailed description

In the US, the CO sends both calling party name and number, if they are available; in Japan, the CO sends only the calling party number.

Display of calling party information works with all DEFINITY ECS digital voice terminals (DCP and BRI) equipped with a 40-character or 32-character alphanumeric display. The analog voice terminals supported are the 7315H and 7317H series (System 25/MERLIN sets supported by DEFINITY).

For the ICLID on analog trunks, DEFINITY ECS stores and displays 15 characters of name and number information. If a name/number is longer than 15 characters, the name/number truncates to 15 characters.

In the absence of caller ID information, or in the case of a CO transmission error, the trunk group name and trunk access code display.

## Interactions

### ■ Attendant Display Features

A redirected call to either the attendant or attendant queue causes the display on the attendant's station to read similar to that of the connected party station display.

### ■ Automatic Display of Incoming Call Identification

If a new call comes in while the station user is off-hook and connected to a call, the display automatically shows the new incoming call identity for 30 seconds. After 30 seconds, the display returns to the selected call. If the call redirects after a few rings, the display returns to the selected call. If an incoming call drops and that call currently displays, the display returns to the selected call.

### ■ Bridged Call

Incoming call identity displays on both the primary station and the bridged station.

### ■ Call Forwarding

Forwarded-From Station Display — no information displays on the called principal's station.

Forwarded-To Station Display — shows the identity of the calling and called party and the reason (R) code. If the forwarded-to station is on a different switch, the called party information does not forward.

## 4 Basic Features

### *Incoming Call Line Identification on Analog Trunks*

Page 4-375

#### ■ Call Pickup

Called Party Station Display — shows the calling party's identity.

Answering Party Station Display — If Call Pick-Up answers an ICLID call, the display shows both the calling party and the called principal's identities.

#### ■ Call Coverage

Called Principal's Display — The called principal's display shows the calling party's identity until the coverage party answers the call. If the coverage party answers the call, the principal's station display becomes blank. If the called principal temporarily bridges in after the coverage party answers the call, then the coverage party and the called principal's displays change to indicate a conference call.

Coverage User Station Display — The coverage user's station display shows the same display as the connected party station display.

#### ■ Call Vector Routing

When an ICLID call coming from analog trunks transfers to a Vector Directory Number (VDN), the incoming calling number is directed to VDN so call vector routing can be based on the ICLID information.

The ANI received for the incoming call (via inband or ISDN) forwards with a route-to step over a trunk that supports ANI delivery (inband or ISDN).

#### ■ DCS Feature Interaction

If the DEFINITY ECS has both DCS and ISDN display features, the ICLID information displays in DCS formats.

#### ■ Hold

When activated, the display becomes blank. The party activating the Hold reads the newly connected party's identity. The held station's display remains unchanged. When the party unholds, the display refreshes to indicate the call's current state.

#### ■ Malicious Call Trace

When activated for a particular call, MCT displays incoming calling numbers to controller stations.

#### ■ Tandem Operations

The calling party name/number passes to the terminating switch over ISDN trunks with DCS+.

#### ■ Transfer

When an ICLID call transfers, the display of the transferred-from station becomes blank. The transferred-to station displays the identity of the transferred-from party if the transfer is not yet completed. Once the transfer completes, the transferred-to station displays the identity of the calling party.

## Individual Attendant Access

---

Individual Attendant Access allows you to access a specific attendant console and assign each attendant console an individual extension.

### How to administer Individual Attendant Access

---

#### Required forms

---

| Form               | Field                                   | Page                 |
|--------------------|---|----------------------|
| Dial Plan Record   | ■ First Digit Table                     | <a href="#">5-99</a> |
| Attendant Console  | ■ Extension<br>■ Name<br>■ COR<br>■ COS | <a href="#">5-35</a> |
| Console Parameters | ■ All                                   | <a href="#">5-86</a> |

### Detailed description

---

A user can access an individual attendant by dialing the extension assigned to the attendant. You can also assign an individual attendant extension to a users' abbreviated-dialing button for fast access to the attendant.

An individual attendant, when called, can extend the call to another trunk or extension.

Each attendant has a queue for incoming calls.

Whenever a call is in an attendant's queue, the top lamp of the Forced Release button (basic console) or the Personal lamp (enhanced console) light. Console Call Waiting tones are provided only on calls to the attendant group, not on calls to individual attendants.

An attendant can be a part of a hunt group. The hunt group can be a DDC group or a UCD group. Calls to individual attendants and calls to the attendant group have priority over hunt-group calls to individual attendants.

Any call made from an attendant console that is assigned an individual extension is considered to be made from the individual attendant, not the attendant group.



## Considerations

---

- Individual attendant extensions allow attendants to use features that an attendant group cannot use — for example, extensions can be members of a DDC or UCD group. An individual attendant extension can have its own Class of Restriction and Class of Service.
- The Position Available lamp on the attendant console indicates whether or not attendant-group calls can be accepted. The lamp does not indicate whether or not individual attendant calls can be accepted.
- Each attendant console has one position-busy button. When the button lamp lights, the attendant does not receive attendant group calls but can still receive individual attendant calls.
- Because hunt groups offer queuing and make-busy features, you may wish to assign an individual attendant as the only member of a hunt group.

## Interactions

---

- Abbreviated Dialing  
Individual attendant extensions can be in Abbreviated Dialing lists. Individual attendants, however, cannot have their own Abbreviated Dialing lists.
- Attendant Display  
For calls to or from individual attendants, attendant names (when specified) display instead of their extensions.
- Attendant Priority Queue  
Calls queue according to the priority assigned in Attendant Priority Queuing.
- Bridged Call Appearance  
Do not assign individual attendant extensions to a bridged call appearance.
- Busy Verification of Terminals and Trunks  
An individual attendant extension cannot be busy-verified.
- Call Coverage  
Individual attendant extensions can be points in a coverage path but cannot be members of a coverage answer group.
- Call Park  
Individual attendants can park calls on their own extensions or other individual attendant extensions.
- Call Pickup  
Individual attendant extensions cannot be in Call Pickup groups.

## 4 Basic Features

### *Individual Attendant Access*

Page 4-378

- **Centralized Attendant Service**

Access individual attendants when CAS is in effect.
- **COR and COS**

Each individual attendant extension has its own COR and COS. Assign an individual attendant and the group with which the attendant is associated to the same COR.
- **Hunt Groups**

Assign individual attendant extensions to DDC and UCD groups. Unlike voice-terminal users, individual attendants can answer DDC and UCD calls as long as there is an idle call appearance and no other DDC or UCD call is on the console.
- **Facility Busy Indication**

Store an individual attendant extension in a Facility Busy Indication button.
- **Integrated Directory**

Store the names and extensions of individual attendants in the Integrated Directory.
- **Leave Word Calling**

A message from an attendant indicates whether it is from the attendant group or an attendant with an individual extension.
- **Night Service — Night Console Service**

This feature affects only calls to the attendant group. Allow calls to individual attendant extensions when night service is active. A night-only attendant console with an individual extension can receive individual attendant calls when night service is active.
- **Privacy — Attendant Lockout**

This feature applies only to attendant-group calls. It does not affect individual attendant calls.
- **Voice Terminal Display**

For calls from individual attendants, attendant names (when specified) display instead of their extensions.

## Integrated Directory

---

Integrated Directory allows users with display-equipped terminals to access the system directory, use the touch-tone buttons to key in a name, and retrieve an extension from the directory. The directory contains the names and extensions assigned to all voice terminals administered in the system.

The use of Vector Directory Number names and extensions is not supported for this feature.

### How to administer [Integrated Directory](#)

---

#### Required forms

---

| Form                                  | Field  | Page                 |
|---------------------------------------|--|----------------------|
| Station                               | <ul style="list-style-type: none"> <li>■ Feature/Display Button Assignments                             <ul style="list-style-type: none"> <li>— directory</li> <li>— next</li> <li>— call-disp</li> </ul> </li> </ul> | <a href="#">6-14</a> |
| Attendant Console                     | <ul style="list-style-type: none"> <li>■ Feature/Display Button Assignments                             <ul style="list-style-type: none"> <li>— directory</li> <li>— next</li> <li>— call-disp</li> </ul> </li> </ul> | <a href="#">5-35</a> |
| Station — 7404D<br>(Data Module page) | <ul style="list-style-type: none"> <li>■ All</li> </ul>  | <a href="#">6-90</a> |

### Detailed description

---

Administer the names in the directory on the Individual Voice Terminal forms. Names cannot exceed 27 characters (including spaces and commas). Enter names in one of the following formats:

- Last name, comma, first name, space, middle name or initial (if desired).  
 For example:
  - Jones, Betty Ann
  - Smith, A E
  - Thomas, John J
  - Abbott, Lynn

## 4 Basic Features

### Integrated Directory

Page 4-380

- First name, space, second name or initial, space, and last name. For example:
  - Betty Ann Jones
  - A E Smith
  - John J Thomas
  - Lynn Abbott
- A single entry is also acceptable. For example:
  - Cafeteria
  - 1J409
  - 2F816
  - Purchasing

Characters allowed in the directory database are the alphanumeric characters (A–Z, a–z) and digits (0–9) as well as space ( ) and comma (,) for delimiters. In addition, the following special characters are allowed: hyphen (-), apostrophe ('), period (.), slash (/), and ampersand (&).

Use touch-tone buttons to key in the numbers and letters labeled on them. The following exceptions apply:

- **7** (PRS) is also used for a Q.
- **9** (WXY) is also used for a Z.
- **\*** is used for a space or comma.
- **#** is not used.

To activate the directory, the user presses the Integrated Directory button. This puts the voice terminal in Integrated Directory mode and turns off the tones that are normally generated when touch-tone buttons are pressed. The touch-tone buttons now are used exclusively for keying in names and not for dialing.

After the Integrated Directory button is pressed, the alphanumeric display shows `DIRECTORY – PLEASE ENTER NAME`. Names are always keyed in the following order: last name, comma, first name or initial. If a character outside the allowed set is entered as the name of a station or data module, the directory search for that name fails.

When a button is pressed, the display shows the first name that matches the first letter on the button. The user can continue to enter letters to narrow the search. When the desired name and extension are displayed, the user can automatically place a call to that person by pressing the Call Display button.

If the user enters a name that cannot be found in the directory, the display shows `NO MATCH – TRY AGAIN`.

To exit Integrated Directory mode, the user presses another mode button, such as the Normal mode button.

## Considerations

---

- Integrated Directory saves users time looking up names and extensions. Instead of searching through lists or directories, a user simply keys in the desired name and the display shows the name and extension.
- If more than the maximum number of users try to activate the feature at the same time, the Integrated Directory button lights and the display shows *Directory unavailable — Try Later*.
- The entire directory cannot be searched by pressing just one key, such as 2. Pressing 2 and then continually pressing Next Message displays, one by one, all entries beginning with A, B, C, and 2. If all entries have been displayed and Next Message is pressed again, the display repeats from the first entry in the listing associated with 2.
- When the voice terminal is in Integrated Directory mode, it cannot be used to make calls or access features by dial code. It can, however, still be used to activate other features or to place calls for which dialing is not required. Also, a user can enter Integrated Directory mode while active on a call, and can receive calls while Integrated Directory mode is active.

## Interactions

---

- Attendant Display and Voice Terminal Display  
If prefixed extensions are used in the system's dial plan, the prefix is not displayed when the extension is displayed. The Call Display button can be used to dial prefixed extensions because the system dials the prefix, even though it is not displayed.
- Distributed Communications Systems  
This is not a DCS feature. Integrated Directory does not work between DCS nodes.
- Merlin<sup>®</sup>/System 25 Voice Terminal Support — 731xH Series Support  
The Merlin/System 25 7309H, 7313H, 7314H, 7315H, 7316H, and 7317H voice terminals do not support Integrated Directory displays.
- Touch-Tone Dialing  
Call origination and feature access by dial code are not allowed when Integrated Directory is active.

## **Integrated Services Digital Network — Basic Rate Interface Endpoints**

---

The Integrated Services Digital Network (ISDN) eliminates the need for multiple, separate access arrangements for voice, data, facsimile, and video services and networks. Using the same pair of wires that now carry simple telephone calls, ISDN delivers voice, data, and video services in a digital format.

ISDN is a global access standard established by the Consultative Committee for International Telephone and Telegraph (CCITT). ISDN uses a layered protocol that conforms to layers one (physical), two (link), and three (network) of the 7-layer Open Systems Interconnect (OSI) Reference Model of the International Standards Organization (ISO).

DEFINITY ECS supports the two major interfaces specified in the ISDN standards: Primary Rate Interface (PRI) and Basic Rate Interface (BRI).

- ISDN-PRI connects premises equipment such as switches to the network, and acts as a powerful interface between intelligent equipment such as switches and computers.
- ISDN-BRI connects telephones, personal computers, and other desktop devices to higher-order equipment, such as a switch. It can also connect ISDN-BRI trunks. (See [“ISDN-BRI trunk group” on page 7-198.](#))

Both PRI and BRI are based on the same common building blocks — the use of a common interface to a transmission path that is divided into channels. Both PRI and BRI use 2 types of channels for communication:

- Bearer channels (B-channels) are the communications links in ISDN. They provide 64-Kpbs digital communications service for voice, data, video, and other information transmission.
- Data channels (D-channels) are the signaling links in ISDN. They carry call-control and call-related information, such as caller ID, between ISDN endpoints. An endpoint may be a BRI voice terminal, BRI data module, or integrated BRI voice and data terminal.

ISDN-BRI is a 192-Kpbs interface that carries two 64-Kpbs B-channels and one 16-Kpbs D-channel. Although ISDN-BRI supports data transmission on the D-channel, DEFINITY ECS does not support this capability, and provides only signaling on this channel. ISDN-BRI provides much of the same functionality provided with the Digital Communications Protocol (DCP).

## How to administer ISDN-BRI

---

### Required forms

---

| Form                  | Field | Page                  |
|-----------------------|-------|-----------------------|
| Station (7500 series) | ■ All | <a href="#">6-130</a> |
| Station (8500 series) | ■ All | <a href="#">6-130</a> |
| 7500 Data Module      | ■ All | <a href="#">6-252</a> |

## Detailed description

---

DEFINITY ECS supports the following transmissions across ISDN-BRI to an endpoint:

- A single voice call
- A single data call
- A voice call and a data call simultaneously
- Two simultaneous data calls

ISDN-BRI offers two possible configurations: multipoint and point-to-point.

### Multipoint configuration

In this configuration, the system supports two ISDN-BRI endpoints per port. Endpoints can be:

- Both voice-only
- Both data-only
- One voice-only and one data-only

Both endpoints on a port connect to the switch by the same wire. One endpoint uses the B1-channel and the other uses the B2-channel. Each endpoint has its own ISDN-BRI and its own extension. The system distinguishes between the 2 endpoints by means of each endpoint's unique Service Order Profile Identifier (SPID).

If two endpoints can each support only one call, then you can administer both endpoints on the same BRI port so as to provide a multipoint configuration. In this case, 2 calls potentially can use the two B-channels simultaneously.

## Point-to-point configurations

In this configuration, the system supports one ISDN-BRI endpoint per port. The endpoint can be:

- Voice-only
- Data-only
- Integrated voice and data

When one endpoint can support two simultaneous B-channel calls, you must configure the endpoint as point-to-point. This is because the two services potentially can use both B-channels simultaneously.

Even though an integrated voice and data endpoint supports both voice and data calls, the integrated endpoint does not use a multipoint configuration because it uses only one endpoint.

## Service Profile Identifier

When more than one endpoint is connected to a BRI port (for example, a multipoint configuration), the switch uses the SPID to associate endpoints with the administered station or data-module extensions. The SPID enables the switch to differentiate between the endpoints connected to the same BRI port.

You first must administer the SPID on the Station or Data Module forms. Then you can program the SPID in the BRI endpoint using the procedure in the endpoint's user manual. During initialization, the endpoint sends the SPID to the switch. The SPID you administered on the Station or Data Module forms must match the SPID programmed into the endpoint. Otherwise, the system restricts service to that endpoint.

A multipoint configuration requires SPID administration and programming. However, SPID administration is optional in a point-to-point configuration because only one endpoint is connected to the BRI port. If you administer the SPID in a point-to-point configuration, the SPID must match the SPID programmed into the endpoint. If you do not administer the SPID, the switch uses the port to associate the endpoint to the administered station or data module extension.

## Terminal Equipment Identifier

The terminal equipment identifier (TEI) initiates communication between the switch and an endpoint. DEFINITY ECS supports two types of TEIs: fixed and automatic.

A fixed TEI endpoint supports one fixed TEI value (0 to 63), which is encoded into the terminal equipment and the fixed TEI initialization procedure. When you administer a fixed TEI endpoint, you must assign the endpoint's fixed TEI value to the Station form or Data Module form for that endpoint. If the endpoint's fixed TEI



## 4 Basic Features

value differs from the TEI that is assigned to the Station form or Data Module form for that endpoint, communication is not established between the switch and the endpoint. As a result, the endpoint is incapable of providing services. Normally, the manufacturer specifies the fixed TEI value that is encoded into the terminal or provides procedures for modifying the fixed TEI value.

An automatic TEI endpoint supports automatic TEI initialization procedures. It receives a TEI from the system during initialization. With automatic TEI endpoints, you do not enter any TEI values to the Station form or Data Module form. In multipoint configurations, you can use only the automatic TEI endpoints. Currently, all supported BRI endpoints are automatic TEI endpoints.

### **ISDN-BRI voice/data terminal equipment**

Voice transmission on ISDN-BRI is provided by the 7505, 7506, 7507, 8503T, 8510, and 8520 voice terminals. All tests and services available to DCP (Digital Communications Protocol) users are also available to BRI users.

Data transmission on ISDN-BRI is provided by the 7500 Data Module (or a compatible stand-alone data module) and the Asynchronous Data Module (ADM). The 7500 Data Module is a stand-alone unit that supports asynchronous or synchronous Data Communications Equipment (DCE) and asynchronous Data Terminal Equipment (DTE):

- In asynchronous mode, the 7500 supports packet-switched or circuit-switched data communications. You control the 7500 via the front panel or the keyboard of a connected terminal.
- In synchronous mode, the 7500 supports circuit-switched or nailed-up data communications. In this mode, the 7500 requires either the Multipurpose Enhancement Board or the High-Speed Synchronous Enhancement Board. You control the 7500 via the front panel only.

The Asynchronous Data Module (ADM) may be used with asynchronous DTE as a data stand for 7500-series ISDN-BRI voice terminals. The ADM consists of a board located inside the ISDN-BRI voice terminal. It allows the transmission of integrated voice and data through one voice terminal. (Separate extensions are used for the voice and data calls.) The ADM supports the Hayes command set for compatibility with PC communications packages.

The PC/ISDN Platform provides both voice and data transmission and is part of the AT&T PC Interface package, Group 3. You can use the PC/ISDN Platform in a stand-alone (no associated voice terminal) configuration. When used in a stand-alone configuration or with a handset or headset, rather than with one of the 7500 series voice terminals, PC/ISDN Platform does not support Management Information Messages (MIMs). Therefore, these stations do not perform an initialization procedure with the switch. They also do not require a SPID and do not initiate or respond to MIMs. Even when the platform is used with

a 7500 series voice terminal, you should still administer the endpoint (combined PC and phone) as a noninitializing terminal that does not support MIMs.

**⇒ NOTE:**

When more than one PC/ISDN interface card is used on the same PC, each card provides a separate interface and is translated on the switch with its own Equipment Line Location (ELL) as a separate station.

### Endpoint initialization

To be fully operative, BRI endpoints must successfully complete endpoint initialization. Initialization usually occurs at installation time or as part of reconfiguration.

### Multipoint configurations on BRI ports

Passive-bus multipoint configuration, supports two BRI endpoints per port. When you change from point-to-point to multipoint configuration, you need not reinitialize the original endpoint. However, in a multipoint configuration, you can administer only endpoints that support SPID initialization.

### Exchange of user information

The BRI protocol allows users to exchange up to 128 octets of user information end-to-end. The information is passed in user-to-user information elements (IE) without being interpreted by the switch.

## ISDN-BRI data service

### Basic digit dialing

Regular digit dialing is provided through the ADM. System users enter digits 0 to 9, \*, and #. They can dial from either the set keypad or the EIA (Electronic Industries Association) terminal interface.

### Default Dialing

Default Dialing is an enhancement to Data Call Setup. If you administer Default Dialing and users either type **d** or press the data button twice, the switch terminates the call to the default address. If you do not administer Default Dialing, the call disconnects. Default Dialing and Data Hotline are mutually exclusive.

### Data Hotline

Data Hotline is a security feature that allows a user to enter a `Dial` command, with no address specified. The switch terminates the call to a pre-administered hotline destination. If a user enters an address, either intentionally or unintentionally, the system routes the call as if the user had entered the hotline destination address. This service does not impose any restriction on incoming calls received at the endpoint. Data Hotline and Default Dialing are mutually exclusive.

## Administered Connections

Administered Connection (AC) causes the system to establish an end-to-end connection between two access endpoints or data endpoints automatically when the system is restarted or AC is administered and active. You define the attributes of these connections on the Administered Connection form via the G3-MT.

Once you have administered the ADM as one endpoint of an AC, the system waits for the scheduled time to initiate the connection. At the scheduled time, the system establishes the connection and maintains it for the specified length of time. Once the call is accepted, the set enters into the continuous mode for the specified length of time. If the switch is rebooted during the continuous connection, the connection re-initiates call setup. If the connection drops, the switch re-initiates call setup.

## Call request

DEFINITY ECS handles all currently defined BRI bearer data-call requests. Capabilities that Lucent terminals do not support may be supported by non-Lucent terminals. For those capabilities the switch does not support, a proper cause value is returned to the terminal.

Cause values identify why a call is cleared. The BRI data modules convert certain cause values to text messages for display.

## Considerations

---

- The system supports up to 60 simultaneous voice calls on a BRI. You can administer two 7507 terminals on a BRI port, each of which supports up to 30 call appearances/bridged appearances.
- DEFINITY ECS supports BRI data endpoints that perform layer 2 disconnect. Administer these endpoints as non-MIM-supporting data-only endpoints.
- DEFINITY ECS supports BRI voice and data terminals that perform enbloc sending with any one of the following formats:
  - A SETUP message with all the digits in the Keypad IE and a Sending Complete IE
  - A SETUP message with all the digits in the Called Party Number IE and a Sending Complete IE
  - A SETUP message with all the digits in the Called Party Number IE and no Sending Complete IE
- The following features are *not* provided to BRI users:
  - Because the ISDN-BRI protocol requires that the bearer capability must be specified when sending the SETUP message and cannot be changed during the call, some functions cannot be provided to

## 4 Basic Features

### *Integrated Services Digital Network — Basic Rate Interface Endpoints*

Page 4-388

BRI voice users. The following functions require a change in the bearer capability after a call is established and so are not available to BRI voice users:

- One-button voice-call setup transfer to data
  - One-button data-call setup transfer to voice
  - Pre-indication of a data call
  - Voice-call transfer to data and data-call transfer to voice
- Features using the switchhook and Recall button (for example, Call Waiting and Analog Conference/Transfer/Hold/Drop) are available on analog voice terminals only.
- If users with 7506D or 7507D terminals make calls that require additional digits, the terminal inserts a comma in the displayed dial sequence to separate the called number from subsequent information.
  - Separate extensions numbers are used for voice and data calls to the same endpoint.
  - Two simultaneous data calls to a single endpoint use the same extension number.

## Interactions

- **Busy Tone Forward Disconnect**

BRI terminals require that Busy Tone Forward Disconnect (BTFD) be turned off. With BTFD off, an agent with Malicious Call Trace is able to change states after a call.
- **Data button**

Besides the call appearance and feature buttons, BRI voice/data terminals have a fixed, dedicated data button (button 7 on the 7505D and 7506D voice terminals, and button 31 on the 7507D voice terminal) that is used for data-call setup. In general, feature buttons such as Call Forwarding or Send All Calls buttons are always associated with voice features, and cannot be used in conjunction with the data button. For example, the user cannot activate Call Forwarding for the associated data endpoint by using the data button followed by the Call Forwarding button and the designated extension.
- **Interworking**

The same off-premises call types are permitted as for DCP, with the exception of voice-to-data and data-to-voice transfer.
- **Modem Pooling**

Modem Pooling provides the necessary protocol conversion between Mode 2 digital data endpoints and analog data facilities. A modem pool resource needs to be inserted during call setup for both call origination

## 4 Basic Features

### *Integrated Services Digital Network — Basic Rate Interface Endpoints*

Page 4-389

and call answering. This resource translates data between Digital Multiplexed Interface (DMI) Mode 2 protocol used by BRI data endpoints and the modulated signal used by the modem.

- Preselection

When the user of an ISDN-BRI station assigned with the `Select Last Used Appearance` field set to `y` completes a transfer while off-hook using the handset, the user hears a dial tone on the last-used appearance, rather than silence.

- Voice Terminal Display

BRI terminals control their displays. For example, when a user dials state (BRI terminal is in the `Overlap Sending` state), any display information sent to the terminal from the switch is buffered. When the state changes, the information displays.

The 7506 BRI voice terminal, which has a 2-line, 24-character display, splits a message when it recognizes a blank closest to the 24th character. This is left to the discretion of the terminal. As a result, the switch has no control over it.

## Intercept Treatment

---

Intercept Treatment provides an intercept tone or a recorded announcement or routes the call to an attendant for assistance when calls cannot be completed or when use of a feature is denied.

A Vector Directory Number (VDN) extension cannot be administered to receive intercept treatment.

### How to administer Intercept Treatment

---

#### Required forms

---

| Form                              | Field                              | Page                  |
|-----------------------------------|------------------------------------|-----------------------|
| Feature-Related System Parameters | ■ DID/Tie/ISDN Intercept Treatment | <a href="#">5-123</a> |
|                                   | ■ Controlled Restrictions          |                       |
| Announcements/Audio Sources       | ■ Port                             | <a href="#">5-26</a>  |

---

### Detailed description

---

#### Intercept Treatment — Tone

Intercept Treatment — Tone provides a siren-type tone to internal calls that cannot be completed as dialed.

Users hear the tone when they lift the handset and do not dial within 10 seconds, pause longer than 10 seconds between digits during the dialing process, or remain connected to Loudspeaker Paging Access for longer than an administered interval.

If a voice terminal is assigned a Class of Service (COS) with Off-hook Alert, and the user of that voice terminal receives a tone for a specified period of time and does not hang up, an emergency call is placed to the attendant.

On Direct Inward Dialing (DID) calls, if Multifrequency Compelled Signaling (MFC) Intercept Treatment is set to provide a tone, this tone is sent to the central office (CO) to indicate that the called number is not valid.

On DOD calls using MFC signaling, if the PBX receives MFC intercept tone from the CO indicating that the dialed number called is not valid, the PBX sends an intercept signal to the calling station.

## Intercept Treatment — Recorded Announcement

Intercept Treatment — Recorded Announcement provides a recorded announcement to DID and incoming Private Network Access calls that cannot be completed as dialed or that are transferred to incomplete or restricted stations. You select and record the message.

Toll charges do not apply to DID and Private Network Access calls routed to Intercept Treatment — Recorded Announcement.

## Intercept Treatment — Attendant

Intercept Treatment — Attendant allows attendants to provide information and assistance to callers on all DID or incoming Private Network Access calls that cannot be completed as dialed or that are transferred to incomplete or restricted stations. Normal toll charges apply to these calls.

## Intercept Treatment — Station

Intercept Treatment — Station allows a voice terminal to receive certain calls that cannot be completed because of a controlled restriction or because the called party has activated Do Not Disturb. Controlled restrictions that can be administered to send calls to station intercept are Outward, Termination, and Station-to-Station.

The calling party receives no indication that the call is receiving Intercept Treatment.

## Considerations

---

- Only one person can be connected to an analog or auxiliary trunk announcements at any given time. The caller is always connected to the beginning of the announcement.
- Integrated announcement boards have 16 channels and each channel can play the same announcement from the beginning. Therefore, up to 16 calls can be listening to the intercept announcement.

## Interactions

---

- MF Signaling

For DID MF signaling calls, whether the corresponding B.x signal or the intercept tone should be sent to the CO is administrable. The default is to send the standard DID/TIE/ISDN Intercept Treatment described in this section. If the option to send the B.x signal is set, then:

- For Group II calls, the B.x signal for the intercept is sent to the CO.
- For non-Group II calls, if the CO dials an invalid number, the trunk is locked (regardless of this option). If the CO dials a number that is valid but not assigned, intercept tone is sent to the CO.

- Recorded Announcement

Attendant Intercept and Recorded Announcement Intercept (both optional) cannot be used together. DID calls and private-network calls cannot be assigned Intercept Treatment — Tone.



## Intercom — Automatic

---

Intercom — Automatic provides a talking path between two voice-terminal users. Calling users press the Automatic Intercom button and lift the handset, or vice versa. Called users receive a unique intercom alerting signal, and the status lamp associated with the Automatic Intercom button, if provided, flashes.

### How to administer [Intercom — Automatic](#)

---

#### Required forms

---

| Form                      | Field  | Page                  |
|---------------------------|--|-----------------------|
| Intercom Group            | ■ All  | <a href="#">5-175</a> |
| Station (multiappearance) | ■ Button/Feature Button Assignments — auto-icom (Grp:__ DC:__) | <a href="#">6-14</a>  |

### Considerations

---

- Users who frequently call each other can do so by pressing one button instead of dialing an extension number.
- Single-line voice-terminal users can receive Automatic Intercom calls, but cannot originate them.
- A combination of Intercom — Automatic and Intercom — Dial can be used between terminals so that Intercom—Automatic applies in one direction and Intercom — Dial applies in the other.
- Two terminals with Intercom — Automatic to and from each other, or terminals with combined Intercom — Automatic and Intercom — Dial to each other, must be in the same Intercom group.

### Interactions

---

- Call Appearance
 

A station with Intercom — Automatic must have at least one Call Appearance translated. Intercom calls terminate to this call appearance and cause the appropriate feature button (auto-icom) to flash. Intercom calls cannot terminate to a bridged appearance.
- Call Coverage
 

Intercom calls are redirected only if the caller activates Go to Cover.
- Call Pickup/Directed Call Pickup
 

If on the Feature-Related System Parameters form, Call Pickup on Intercom Calls is set to **y**, Call Pickup and Directed Call Pickup can be used to answer an Automatic Intercom call. If the field is set to **n**,

## 4 Basic Features

### *Intercom — Automatic*

Page 4-394

Automatic Intercom calls cannot be picked up using Call Pickup or Directed Call Pickup. The calls are not included in the call-pickup alerting count.

- Class of Restrictions (COR)

You can administer COR so that station A cannot call Station B. In this case, Station A receives intercept tone when attempting a call. However, the same Station A can have Intercom — Automatic capability to Station B. In this case, A could call B via automatic intercom. Therefore, you need to use both station restrictions and Intercom groups to restrict a station from calling other stations.

- Data Privacy and Data Restriction

An extension with Data Privacy or Data Restriction activated cannot originate an intercom call. Intercept tone is received when the ICOM button is pressed under this condition.

- Intercom — Dial

This feature must be provided. Users assigned an Automatic Intercom button must be a member of the same Dial Intercom group as the destination extension.

- Single-Digit Dialing and Mixed Station Numbering

Prefixed extensions longer than five digits (including prefix) cannot be assigned to intercom lists.

## Intercom — Dial

---

Intercom — Dial allows multiappearance voice-terminal users to gain rapid access to other voice-terminal users within an administered group. Calling voice-terminal users lift the handset, press the Dial Intercom button, and dial the 1-digit or 2-digit code assigned to the desired party. The called user receives alerting tone, and the status lamp associated with the Intercom button, if provided, flashes.

### How to administer Intercom — Dial

---

#### Required forms

---

| Form                      | Field  | Page                  |
|---------------------------|--|-----------------------|
| Intercom Groups           | ■ All  | <a href="#">5-175</a> |
| Station (multiappearance) | ■ Button/Feature Button Assignments<br>— dial-icom (Grp: __) | <a href="#">6-14</a>  |

---

### Considerations

---

- A group of users who frequently call each other can do so by pressing a Dial Intercom button and dialing a code instead of an extension.
- Single-line voice terminals can receive Intercom — Dial calls, but cannot originate them.
- A combination of Intercom — Dial and Intercom — Automatic can be used between terminals so that Intercom — Dial applies in one direction and Intercom — Automatic applies in the other.
- A Intercom — Dial user can place an intercom call to all members in the group, including Intercom — Automatic members.
- Two terminals with Intercom — Dial to and from each other, or two terminals with combined Intercom — Dial and Intercom — Automatic to and from each other, must be in the same Intercom group.

### Interactions

---

- Call Appearance

A station with Intercom — Dial must have at least one Call Appearance translated. Intercom calls terminate to this call appearance and cause the appropriate feature button (dial-icom) to flash. Intercom calls cannot terminate to a bridged appearance.

- Call Coverage

Intercom calls are redirected to Call Coverage only if the caller activates Go to Cover.
- Call Pickup and Directed Call Pickup

If on the Feature-Related System Parameters form, `Call Pickup on Intercom Calls` is set to **y**, Call Pickup and Directed Call Pickup can be used to answer an Automatic Intercom call. If the field is set to **n**, Automatic Intercom calls cannot be picked up using Call Pickup or Directed Call Pickup. The calls are not included in the call-pickup alerting count.
- Data Privacy and Data Restriction

An extension with Data Privacy or Data Restriction activated cannot originate an intercom call. Intercept tone is received when the ICOM button is pressed under this condition.
- Intercom — Automatic

Users who are assigned this feature must be a member of a Dial Intercom group.
- Single-Digit Dialing and Mixed Station Numbering

Prefixed extensions longer than five digits (including prefix) cannot be assigned to intercom lists.

## Internal Automatic Answer

---

Internal Automatic Answer (IAA) provides convenient hands-free answering of internal calls to some voice-terminal users on most multifunction stations with a speakerphone or a headphone.

### How to administer IAA

---

#### Required forms

---

| Form                              | Field  | Page                  |
|-----------------------------------|--|-----------------------|
| Feature-Related System Parameters | <ul style="list-style-type: none"> <li>■ Internal Automatic Answer for Attendant Extended Calls</li> </ul> | <a href="#">5-123</a> |
| Station (multi-appearance)        | <ul style="list-style-type: none"> <li>■ All</li> </ul>  | <a href="#">6-28</a>  |

### Detailed description

---

An eligible call can be answered automatically via IAA if the user activates IAA at the answering voice terminal and the terminal is not active (on-hook and able to accept an incoming call). A voice terminal is active if it is off-hook, is in the process of dialing digits, or has a call on hold.

The following internal calls are eligible for IAA:

- Station-to-station voice calls, with both voice terminals on the same switch (includes redirected intraswitch calls)
- Internal call from another switch node in a DCS configuration when the origin of the call is known to be an internal, non-attendant voice terminal on that switch (includes redirected inter-DCS calls)
- Attendant-extended external calls if you enable `Internal Automatic Answer for Attendant Extended Calls`

The following calls are *not* eligible for IAA:

- Calls from public-network trunks (including PCOL)
- Calls from non-DCS tie trunks
- Automatic Callback calls
- Automatic Circuit Assurance calls
- Data calls
- Attendant-extended external calls if `Internal Automatic Answer for Attendant Extended Calls` is disabled

## 4 Basic Features

### Internal Automatic Answer

Page 4-398

- Calls that the system redirects because of a queue overflow of Emergency Access to the Attendant calls
- Calls when the receiving station's `Active Station Ringing` is set to **continuous**

## IAA Feature Operations

With IAA, you can assign a single programmable feature button (IAA) to voice terminals. When the user presses the IAA feature button, the button lamp lights and the system activates IAA. Pressing the same button again deactivates IAA and turns off the status lamp. (Pressing the feature button has no effect on a currently-active call or a ringing call.) The IAA button may be toggled on or off at any time, regardless of the state of the voice terminal. Using the speakerphone to place calls does not affect the state of IAA.

The calling voice terminal receives a tone when its call is answered automatically by a voice terminal with IAA. The called voice terminal receives a tone (a ring ping) and then goes off-hook when automatically answering an IAA-eligible call. The answering voice-terminal's speaker and microphone are both turned on.

If a voice-terminal user has IAA active and is currently busy on a call or is in the process of dialing digits, subsequent incoming calls are treated as if IAA were not activated.

## Considerations

---

- Voice-terminal users should always deactivate IAA when leaving the work area. Otherwise, incoming calls are unintentionally answered by the unattended station, and do not go to coverage.
- A 602A terminal is off-hook when the headset or speakerphone is connected. Therefore IAA answers a call if all other call appearances are idle.

## Interactions

---

- Attendant Console  
IAA is not available with Attendant Console.
- Automatic Answer  
You cannot administer both IAA and Automatic Answer simultaneously on the same voice terminal.
- Automatic Call Distribution  
IAA applies internal calls as an ACD agent extension in call.

## 4 Basic Features

### Internal Automatic Answer

Page 4-399

- Automatic Callback

Callback calls via Automatic Callback are not answered automatically by IAA.

- Automatic Circuit Assurance

Calls generated by ACA are not eligible for IAA.

- Bridged Call Appearance — Multiappearance Voice Terminal

Calls terminating on a bridged call appearance are not eligible for IAA at the bridged station, even if the bridged station has IAA active. (IAA can be used by the principal station to answer the call.)

- Bridged Call Appearance — Single-Line Voice Terminal

Calls terminating to a bridged call appearance are not eligible for IAA at the bridged station, even if the bridged station has IAA active.

- Call Coverage

If an internal call is redirected to another voice terminal by Call Coverage redirection criteria, then that call is eligible for IAA at the redirected voice terminal.

IAA does not apply to calls to the original called extension when:

- The called voice terminal has activated Send All Calls
- The calling voice terminal has selected Go to Cover before placing the call

Calls directed to a coverage answering group are not eligible for IAA.

 **NOTE:**

If you set the coverage path for a station to All Calls and that station activates IAA, the first coverage point hears a ring, the principal station automatically answers, and the coverage-simulated bridge is dropped. The coverage station rings, but is not able to answer the call because the coverage-simulated bridge has been dropped.

- Call Forwarding

Calls to a station with IAA and Call Forwarding active are forwarded and are not answered by the station dialed.

 **NOTE:**

If the forwarded-to station is internal and has IAA active, it automatically answers the redirected call.

- Call Park

If you are using Deluxe Paging and Call Park times out, the call returns to the originating station that parked the call and is eligible for IAA.

## 4 Basic Features

### *Internal Automatic Answer*

Page 4-400

- Call Pickup

Internal calls to a voice terminal in a Call Pickup group are eligible for IAA. If the called extension in a Call Pickup group has IAA-active, the call is automatically answered. A voice terminal with IAA active is not able to automatically answer calls to other voice terminals in its Call Pickup group.

- Conference

Internal conference calls can be answered automatically via IAA. If more than one party has joined a conference call through automatic answer, the parties remain connected until they disconnect or the controlling party drops the call.

- Data Call Setup

Data calls are not eligible for IAA.

- Direct Department Calling and Uniform Call Distribution

Internal calls to a DDC or UCD group member are eligible for IAA.

- Distributed Communications System

If a call is from an internal voice terminal on another switch in a DCS configuration, then that call is considered internal and is eligible for automatic answer.

- Do Not Disturb

Do Not Disturb preempts IAA at the called voice terminal.

- Go to Cover

IAA does not apply to calls to the original called extension when the calling voice terminal has selected Go to Cover before placing a call.

- ISDN-BRI

IAA is not available with ISDN-BRI terminals.

- Loudspeaker Paging — Deluxe Paging

When you are using Deluxe Paging and Call Park times out, the call returns to the originating station that parked the call and is eligible for IAA.

- Ringback Queuing

Automatic calls generated by Ringback Queuing are not eligible for IAA.

- Send All Calls

IAA does not apply to calls to extensions with Send All Calls is active.

- Terminating Extension Group

Calls to a Terminating Extension Group extension are not eligible for IAA. However, calls placed to an individual extension are eligible.

- Transfer

Transferred calls are eligible to be automatically answered via IAA.



## International Operator Access

---

International Operator Access allows DEFINITY ECS users in Mexico to make international calls to a central office (CO) operator directory assistance operator using administrable feature buttons on any digital communications system (DCP) telephone and attendant console using R2 multifrequency-compelled (MFC) signaling. This capability is also available in Hong Kong using dual-tone multifrequency (DTMF) signaling. It is possible for users in other countries to use this feature if their DEFINITY ECS is using R2 MFC or DTMF signaling. On R2 MFC signaling, pressing the mf-op-intl and mf-da-intl button causes I.11 and I.12 signals, respectively, to be sent out. On DTMF signaling, pressing the mf-op-intl and mf-da-intl button causes B and C signals, respectively, to be sent out.

### How to administer International Operator Access

---

1. On the third page of the station form, add **mf-op-intl** or **mf-da-intl** to the Feature Button Assignments field.

These are shown when you press the help button to view the administrable feature button choices.

2. Submit the change.



**NOTE:**

On the ARS Digit Analysis form, the pressing of one of these feature buttons is counted as one digit and the Mn and Mx fields should reflect this pressing of the feature button.

#### Required forms

---

| Form               | Field                        | Page                  |
|--------------------|------------------------------|-----------------------|
| Station            | ■ Feature Button Assignments | <a href="#">5-123</a> |
|                    | — mf-op-intl                 |                       |
|                    | — mf-da-intl                 |                       |
| ARS Digit Analysis | ■ Mn                         |                       |
|                    | ■ Mx                         |                       |

---

### Detailed description

---

- International calls to CO operators

A DEFINITY ECS user:

1. Dials the ARS access code
2. Dials the international access code

## 4 Basic Features

### *International Operator Access*

Page 4-402

3. Dials the country code
4. Presses the mf-op-intl button

Ringback, busy, or congestion tone is returned.

- International calls to directory assistance operators

A DEFINITY ECS user:

1. Dials the ARS access code
2. Dials the international access code
3. Dials the country code
4. Presses the mf-da-intl button

Ringback, busy, or congestion tone is returned

## **Considerations**

---

No more digits can be dialed after pressing the mf-op-intl or mf-da-intl feature buttons.

## **Interactions**

---

- Abbreviated Dialing

The mf-op-intl and mf-da-intl feature buttons cannot be programmed and embedded in abbreviated dialing strings.

- Authorization Code

The Authorization Code feature can be used with this feature.

## Last Number Dialed

---

Last Number Dialed allows a user to automatically redial the last number dialed.

The system saves the first 24 digits of the last number dialed, whether the call was dialed manually or with Abbreviated Dialing. When users press the Last Number Dialed button or dial the Last Number Dialed feature-access code, the system places the call again.

### How to administer Last Number Dialed

---

#### Required forms

---

| Form                      | Field  | Page                  |
|---------------------------|--|-----------------------|
| Feature Access Code (FAC) | ■ Last Number Dialed Access Code                   | <a href="#">5-113</a> |
| Station (multiappearance) | ■ Button/Feature Button Assignments<br>— last-numb | <a href="#">6-14</a>  |
| Attendant Console         | ■ Feature Button Assignments<br>— last-numb        | <a href="#">5-35</a>  |

---

### Considerations

---

- Any special characters (Pause, Wait, Mark, or Suppress) that are stored in an Abbreviated Dialing button are outpulsed when the number is redialed.
- Any delays in manual dialing are not reflected when the number is redialed.
- The system does not save Last Number Dialed information to disk, tape, or flash card. The system never saves manually-dialed end-to-end, signaling digits.
- A user can enter a partial number, hang up, and use Last Number Dialed, and manually enter the remaining digits. If the user calls from a display terminal, the manually-entered digits do not display during the dialing sequence, but the system successfully completes the call.

### Interactions

---

- Abbreviated Dialing  
If the previously-called number was in an Abbreviated Dialing privileged list and the user's COR normally prevents the user from dialing the number, the system uses Intercept Treatment when the user presses Last Number Dialed. To redial the number, the user must again use the Abbreviated Dialing privileged list.

4 Basic Features

*Last Number Dialed*

Page 4-404

- Automatic Callback

Users can use Automatic Callback after they use Last Number Dialed on a call to an internal voice terminal.

- Bridged Call Appearance

Last Number Dialed causes the last number dialed from the voice terminal to be redialed, regardless of which extension number is used (primary or bridged call appearance).

- Centralized Attendant Service

Last Number Dialed does not work with CAS. Therefore, if a CAS attendant attempts to extend a call via Last Number Dialed, the call does not complete.

## Leave Word Calling

---

Leave Word Calling (LWC) allows internal system users to leave a short preprogrammed message for other internal users. When the message is stored, the Automatic Message Waiting lamp on the called voice terminal lights. Users can retrieve LWC messages using a telephone display, Voice Messaging Retrieval, or AUDIX. Messages may be retrieved in English, French, Italian, Spanish, or a user-defined language.

DEFINITY ECS also provides voice synthesis (either English or Italian) for LWC, depending on which voice-synthesis circuit pack is installed in the system.

### How to administer LWC

---

#### Required forms

---

| Form                              | Field  | Page                  |
|-----------------------------------|--|-----------------------|
| Feature-Related System Parameters | <ul style="list-style-type: none"> <li>■ Max. Number Of Messages Per Station</li> </ul>                    | <a href="#">5-123</a> |
|                                   | <ul style="list-style-type: none"> <li>■ Message Waiting Lamp Indicates Status For</li> </ul>              |                       |
|                                   | <ul style="list-style-type: none"> <li>■ Stations With System-Wide Message Retrieval Permission</li> </ul> |                       |
| Station                           | <ul style="list-style-type: none"> <li>■ LWC Reception</li> </ul>  | <a href="#">6-14</a>  |
|                                   | <ul style="list-style-type: none"> <li>■ LWC Activation</li> </ul>   |                       |
|                                   | <ul style="list-style-type: none"> <li>■ Button/Feature Button Assignments</li> </ul>                      |                       |
|                                   | <ul style="list-style-type: none"> <li>— lwc-store</li> </ul>  |                       |
|                                   | <ul style="list-style-type: none"> <li>— lwc-cancel</li> </ul>   |                       |
|                                   | <ul style="list-style-type: none"> <li>— aut-msg-wt (Ext:___)</li> </ul>                                   |                       |
|                                   | <ul style="list-style-type: none"> <li>— call-disp</li> </ul>  |                       |
|                                   | <ul style="list-style-type: none"> <li>— msg-retr</li> </ul>   |                       |
| Attendant Console                 | <ul style="list-style-type: none"> <li>■ Feature Button Assignments</li> </ul>                             | <a href="#">5-35</a>  |
|                                   | <ul style="list-style-type: none"> <li>— lwc-store</li> </ul>  |                       |
|                                   | <ul style="list-style-type: none"> <li>— lwc-cancel</li> </ul>   |                       |
|                                   | <ul style="list-style-type: none"> <li>— delete-msg</li> </ul>   |                       |
|                                   | <ul style="list-style-type: none"> <li>— next</li> </ul>   |                       |
|                                   | <ul style="list-style-type: none"> <li>— call-disp</li> </ul>  |                       |
|                                   | <ul style="list-style-type: none"> <li>— aut-msg-wt (Ext:___)</li> </ul>                                   |                       |

### Required forms — *Continued*

| Form                      | Field                          | Page                  |
|---------------------------|--------------------------------|-----------------------|
| Feature Access Code (FAC) | ■ LWC Message Retrieval Lock   | <a href="#">5-113</a> |
|                           | ■ LWC Message Retrieval Unlock |                       |
|                           | ■ LWC Send A Message           |                       |
|                           | ■ LWC Cancel A Message         |                       |

### Detailed description

LWC electronically stores a standard message — for example, CARTER, ANN 2/7 10:45a 2 CALL 3124. This message means that Ann Carter called two times, the last time on the morning of February 7, and wants a return call to extension 3124.

When the system receives identical messages, only the date, time, and number of messages are updated. If nine or more identical messages accumulate, the count remains at nine, and only the date and time are updated.

Messages can be stored by calling users, called users, and covering users as follows:

- Calling user
  - Before dialing the desired extension number, press the LWC button or dial the LWC access code. Then dial the desired number.
  - Before the call is answered, if you are a multiappearance voice-terminal user, press LWC. If you are a single-line voice-terminal user, press Recall and dial the access code.
  - After the call is answered, press LWC or Recall and dial the access code.
- Called user
  - After answering the call, the called user presses LWC to leave a message for the calling user to return their call. (A called user can store an LWC message by dialing the LWC access code only if the called user has an analog voice terminal.)

## 4 Basic Features

### Leave Word Calling

Page 4-407

- Covering user
  - A covering user can be through Call Coverage, Call Pickup, or Call Forwarding All Calls.
  - After answering the call, the covering user presses Coverage Callback to store a message for the called user that tells them to return a call the calling user.
  - After answering the call, the covering user presses LWC to leave a call-me message for the originally called user.

In addition, a user that was placed on hold can activate LWC and leave a message for the holding user to place a return call.

A caller who leaves an LWC message can cancel that message, if it has not already been retrieved. To cancel the message, the calling user lifts the handset, presses LWC Cancel or dials the access code, and then dials the extension of the called party.

The system can indicate that one voice terminal received a LWC message on a second voice terminal. The system lights a remote Automatic Message Waiting lamp at the remote voice terminal and the Automatic Message Waiting lamp lights at the called voice terminal. The Remote Automatic Message Waiting lamp is a status lamp associated with a button assigned for this purpose. Thus, an assistant's voice terminal could light when an executive receives a LWC message. If the executive calls to retrieve messages, the assistant knows at a glance if any messages have been left.

Users without Voice Terminal Display can have their messages retrieved by a system-wide message retriever or by covering users in their Call Coverage path. They can also use Voice Message Retrieval.

The system restricts unauthorized users from displaying, canceling, or deleting messages. The Lock function restricts a voice terminal and the Unlock function releases the restriction. Users activate Lock by dialing a system-wide access code. They cancel Lock by first dialing a system-wide access code and then an Unlock security code unique to the voice terminal. These functions apply only to the voice terminal where the function is active. You can assign a status lamp to show the lock status of the voice terminal.

## Considerations

- You can administer up to 10 terminals (or nine terminals and the attendant console group) as system-wide message retrievers.
- If the stored-message level reaches 95 percent of capacity, the status lamps associated with all Coverage Message Retrieval buttons in the system flash. These lamps continue to flash until the stored-message level

## 4 Basic Features

### Leave Word Calling

Page 4-408

falls below 85 percent. Authorized retrievers can selectively delete messages to gain storage space. Old messages are not purged automatically by the system.

- LWC messages cannot be stored, canceled, or retrieved for Vector Directory Number extensions.

## Interactions

---

- AUDIX Interface

LWC Cancel cannot be used to cancel an AUDIX message.

- Bridged Call Appearance

A LWC message left by a user on a bridged call appearance leaves a message for the called party to call the primary extension for the bridged call appearance. When a user calls a primary extension and activates LWC, the message is left for the primary extension, even if the call was answered at a bridged call appearance.

- Call Coverage

You can use LWC with or without Call Coverage. However, the two features complement each other. The Coverage Callback option of Call Coverage is provided by LWC. Also, a caller can activate LWC for the called party even if the call has been answered by a covering user.

- Centralized Attendant Service

LWC Message Retrieval does not work with CAS.

- Conference

A member of a conference call cannot activate LWC because the user cannot be uniquely identified. After LWC has been activated for a party on a conference or transfer, the conference or transfer originator cannot press Conference/Transfer a second time to return to the original call. The originator must select the call appearance button to return to the previously-held call.

- Expert Agent Selection

With EAS, the Message lamp defaults to tracking the status of messages waiting for the logged-in EAS agent rather than for the physical terminal. You can assign the Message lamp to track the status of messages waiting for the physical terminal.

- MERLIN/System 25 Voice Terminal — 731xH Series Support

MERLIN/System 25 7309H, 7313H, 7314H, 7315H, 7316H, and 7317H voice terminals support LWC but do not support Message Retrieval via the display.

- Vector Directory Number

LWC messages cannot be stored, cancelled, or retrieved through VDN.



## Line Lockout

---

Line Lockout removes single-line voice-terminal extensions from service when users do not hang up after receiving dial tone for 10 seconds or intercept tone for 30 seconds (default).

### How to administer Line Lockout

---

#### Required forms

---

| Form                              | Field                        | Page                  |
|-----------------------------------|------------------------------|-----------------------|
| Feature-Related System parameters | ■ Time before Off-hook Alert | <a href="#">5-123</a> |
|                                   | ■ Line Intercept Tone Timer  |                       |

---

### Detailed description

---

Line Lockout occurs when:

- A user does not hang up after the other party on a call is disconnected.  
The user receives the dial tone for 10 seconds and then receives the intercept tone for 30 seconds. If the handset remains lifted, the voice-terminal is taken out of service.
- A user pauses for 10 seconds between digits while dialing.  
The user receives intercept tone for 30 seconds. If the handset remains lifted, the voice-terminal is taken out of service.

The out-of-service condition remains in effect until the user hangs up.

### Considerations

---

- The out-of-service condition provided by Line Lockout does not tie up switching facilities.
- Line Lockout does not apply to multiappearance voice-terminals.

### Interactions

---

- Intercept Treatment  
Call intercept is provided by Intercept Treatment.

## Listed Directory Numbers

---

Listed Directory Numbers (LDN) has two capabilities that allow outside callers to access your attendant group, depending on the type of trunk used for the incoming call. You use one capability to allow attendant group access via incoming direct inward dial (DID) trunks. You use another capability to allow attendant group access via incoming central office (CO) and foreign exchange (FX) trunks.

### How to administer LDN

---

#### Required forms for incoming DID calls

---

| Form                     | Field | Page                  |
|--------------------------|-------|-----------------------|
| Listed Directory Numbers | All   | <a href="#">5-207</a> |

- Listed Directory Numbers Form
  - Assign listed directory numbers.
  - Assign an optional, associated night-service destination.

#### Required forms for incoming CO or FX trunk calls

---

| Form        | Field                  | Page                  |
|-------------|------------------------|-----------------------|
| Trunk Group | ■ Incoming Destination | <a href="#">7-115</a> |
| — CO        |                        | <a href="#">7-168</a> |
| — FX        |                        | <a href="#">7-193</a> |

### Detailed description

---

The system routes both incoming DID calls and incoming FX and CO calls to an attendant group, depending on how you administer the trunks.

### How the system routes incoming DID trunk calls to the attendant group

Incoming DID calls route only to an extension. The LDN feature allows you to assign one or more extensions to an attendant group. The system uses the LDN extension, or extensions, to route calls to an attendant group.

## How the system routes incoming FX and CO trunk calls to the attendant group

Incoming FX and CO trunks can terminate at an attendant group, although you administer your system to terminate the calls elsewhere. You can administer the system to terminate an incoming FX or CO trunk to one of the following:

- Attendant group
- Extension (This could be a VDN, an ACD split, a DDC group, a UCD group, a remote access extension, or any system extension.)

If you decide to terminate the call at the attendant group, *the system treats the call as an LDN call.*

## Considerations

---

The number of listed directory numbers that you can assign depends on your system's configuration. See *DEFINITY Enterprise Communications Server System Description Pocket Reference* for capacity information.

## Interactions

---

- Night Service

If you activate night-service capability and a night console is not assigned or is not operational, incoming LDN calls route as follows:

- DID LDN calls route to a designated DID LDN night extension. If no DID LDN night extension is designated, DID LDN calls route to the attendant.
- Incoming CO or FX trunk calls route to the night destination specified for the trunk group. If no night destination is specified for the trunk group, the calls route to the normal incoming destination for that trunk group.
- Internal calls and coverage calls to the attendant route to the DID LDN night extension during night service.

## Loudspeaker Paging Access

Customers can have either normal Loudspeaker Paging Access or Deluxe Loudspeaker Paging Access (called Deluxe Paging). Deluxe Paging provides attendants and voice-terminal users with integrated access to voice-paging equipment and Call Park capabilities. When a user activates Deluxe Paging, the call is automatically parked. The parked call returns to the parking user with distinctive alerting when the Call Park Time-out interval expires.

Loudspeaker Paging Access provides attendants and voice-terminal users dial access to voice-paging equipment. The system can provide as many as 9 individual paging zones. In addition, 1 zone can be provided by the system to activate all zones simultaneously. (A zone is the location of the loudspeakers — for example, conference rooms, warehouses, or storerooms.)

### How to administer Loudspeaker Paging Access and Deluxe Paging

#### Required forms

| Form                              | Field   | Page                  |
|-----------------------------------|---|-----------------------|
| Station (multiappearance)         | ■ Button/Feature Button Assignments   | <a href="#">6-14</a>  |
| Attendant Console                 | ■ DTGS Select or Feature Button Assignments   | <a href="#">5-35</a>  |
| Loudspeaker Paging Access         | ■ All   | <a href="#">5-209</a> |
| Code Calling IDs                  | ■ All   | <a href="#">5-84</a>  |
| Feature-Related System Parameters | ■ Call Park Timeout Interval<br>■ Deluxe Paging and Call Park Timeout to Originator | <a href="#">5-123</a> |
| Dial Plan Record                  | ■ All   | <a href="#">5-99</a>  |
| Second Digit Table                | ■ All   | <a href="#">5-264</a> |
| Console Parameters                | ■ Common Shared Extensions  | <a href="#">5-86</a>  |
| Class of Service                  | ■ Console Permission  | <a href="#">5-81</a>  |

#### Detailed description

The system assigns an individual trunk-access code for each of 10 paging zones. Users activate Loudspeaker Paging Access by dialing the trunk access code (TAC) of the desired zone. Users then speak into the handset to make an announcement.

## 4 Basic Features

### *Loudspeaker Paging Access*

Page 4-413

You can store trunk-access codes in Abbreviated Dialing lists. Multiappearance voice-terminal users can then activate paging by pressing Abbreviated Dialing buttons. Attendants can also activate paging by pressing a Direct Trunk Group select button if the desired zone's trunk-access code is assigned to one of the buttons.

In addition to the system loudspeaker paging equipment, you can use a PagePac paging system. The switch paging system requires a separate port for each paging zone, and provides only 9 zones. A PagePac system requires only one port on one circuit pack to provide as many as 39 paging zones.

Loudspeaker Paging Access is particularly useful when used with Call Park. When one user is away from their desk and receives a call, another user can answer the call, park it, and page the called party to tell them that extension to call to retrieve the call. The called party dials the Answer-Back access code and the extension to retrieve the parked call. Note that without Deluxe Paging, paging and parking are two separate operations.

### **Detailed description of Deluxe Paging**

Deluxe paging is similar to Loudspeaker Paging Access, but Deluxe Paging adds the convenience of automatically parking a call. When one user is away from their desk and receives a call, another user can answer the call, and then automatically park the call. The user dials the Loudspeaker Paging TAC (which automatically parks the call) and pages the called party to tell them they have a call. The called party dials the Answer-Back TAC to retrieve the call.

Deluxe Paging also provides Meet-Me Paging and Meet-Me Conferencing functions. With Meet-Me Paging, a user activates Deluxe Paging, makes the announcement for someone to call them back, and hang up. The paged party then calls the paging party. With Meet-Me Conferencing, a user pages another party and adds the party onto a conference call when they call the paging party.

## How to administer PagePac Paging

To use a PagePac paging system, assign a trunk-access code or extension (PagePac 50/100/200 only) to the paging system.

### Required forms

| Form                              | Field                        | Page                  |
|-----------------------------------|------------------------------|-----------------------|
| CPE trunk group                   | ■ All                        | <a href="#">7-174</a> |
| Feature-Related System Parameters | ■ Call Park Timeout Interval | <a href="#">5-123</a> |
| Dial Plan Record                  | ■ All                        | <a href="#">5-99</a>  |
| Second Digit Table                | ■ All                        | <a href="#">5-264</a> |
| Console Parameters                | ■ Common Shared Extensions   | <a href="#">5-86</a>  |
| Class of Service                  | ■ Console Permission         | <a href="#">5-81</a>  |

If you want users to access the PagePac system through a CO or analog station, do not administer the paging system on the Loudspeaker Paging Access form. The system accesses the line as a standard trunk (trunk access code of a CO) or a standard extension (dialed extension that connects to PagePac).

## Detailed description of PagePac Paging

A user simply dials the trunk-access code for the PagePac system to connect to the PagePac equipment. If there is only one paging zone, the user then pages from their handset. If there are multiple zones, the user waits for a steady tone, dials a 1-digit or 2-digit code to access the desired zone, then pages.

Three PagePac paging systems are available:

- PagePac 20  
Provides 1 paging zone. Has an input source for music over the paging system. The music can also serve as the music for the Music-on-Hold Access feature. Additional hardware is available to provide multizone paging for 3, 9, or 39 paging zones.
- PagePac VS  
Provides 1 to 3 paging zones. Permits paging to all zones simultaneously. Additional hardware is available to provide music or talkback.
- PagePac 50/100/200  
Provides up to 24 paging zones. Additional hardware is available to provide music or talkback.

## End user procedures for Deluxe Paging

How users activate Deluxe Paging varies depending on the type of voice terminal they have and whether they are attendants. The following sections explain how users activate Deluxe Paging in various environments.

### **Activating Deluxe Paging: single-line voice-terminal users**

1. Go off-hook to get dial tone.

If already on a call with another party, press the Recall button or flash the switchhook. The other party is placed on hold and you hear recall dial tone.

2. Dial the trunk-access code for the desired paging zone.

You hear dial tone.

3. Dial the extension where the call is to be parked.

You hear a confirmation tone. To park the call on your own extension, dial # instead of the extension.

4. Make the announcement.

The loudspeaker paging timer starts.

5. Press the Recall button and go on-hook.

The paging equipment is released, the parked call waits to be answered, and the timer for the Call Park Time-out interval starts.

If another party was placed on hold in Step 1 and did not go on-hook, that party and you are in conference, parked on the call, and connected to the paged party when he or she answers the call. (This is known as Meet-Me Conferencing.)

If the loudspeaker paging time-out interval expires before you press the Recall button, you receive a confirmation tone, the paging equipment is released, the call is automatically parked on your extension, and the calling party hears music (if provided). When the paged party answers the call, he or she is connected to you. You can then transfer the call to the calling party.

If the Call Park Time-out interval expires, the call returns to you with the proper distinctive alerting (such as, 1 burst for internal calls and conference calls with both internal and external parties; 2 bursts for external calls). If unanswered, the call follows your coverage path.

If no answer-back is required on the call, hang up instead of pressing the Recall button. The parked call is dropped and the paging equipment is released.

### **Activating Deluxe Paging: multiappearance, voice-terminal users**

1. Go off-hook to get dial tone.

If already on a call with another party, press the Transfer button. The other party is placed on hold and you hear dial tone.

2. Dial the trunk-access code for the desired paging zone.

You hear dial tone.

3. Dial the extension where the call is to be parked.

You hear confirmation tone. To park the call on your own extension, dial # instead of the extension.

4. Make the announcement.

The loudspeaker paging timer starts.

5. Press the Transfer button and go on-hook.

The paging equipment is released, the call is parked and is now waiting to be answered, and the timer for the Call Park Time-out interval starts.

If another party was placed on hold in Step 1 and you did not hang-up, that party is parked on the call and you are connected in conference when they answer the call. You can press the Conference button instead of the Transfer button to allow all the parties to connect to you on answer-back.

If the loudspeaker paging time-out interval expires before you press the Recall button, you receive a confirmation tone, the paging equipment is released, the call is automatically parked on your extension, and the calling party hears music (if provided). When the paged party answers the call, he or she is connected to you. You can then transfer the call to the calling party.

If the Call Park Time-out interval expires, the call returns to you with the proper distinctive alerting (such as, 1 burst for internal calls and conference calls with both internal and external parties; 2 bursts for external calls). If unanswered, the call follows your coverage path.

If no answer-back is required on the call, hang up instead of pressing the Transfer or Conference button. The parked call is dropped and the paging equipment is released.

### **Activating Deluxe Paging: attendant for another party**

1. Press the Start button.

The other party is placed on hold and you hear dial tone.

2. Dial the trunk-access code for the desired paging zone.

You hear dial tone.

3. Dial the extension where the call is to be parked.

You hear confirmation tone. To park the call on your own extension (if assigned), you dial # instead of the extension.



## 4 Basic Features

### Loudspeaker Paging Access

Page 4-417

#### 4. Make the announcement.

The loudspeaker paging timer starts.

#### 5. Press the Release button.

The paging equipment is released, the parked call waits to be answered, and the timer for the Call Park Time-out interval starts. If the you press the Split button, the timer for the Call Park Time-out interval starts, and both the held party and you are parked and connected to the call upon answer-back.

If the loudspeaker paging time-out interval expires before you press the Release button, you receive confirmation tone, the paging equipment is released, the call is automatically parked on the console, and the calling party hears music (if provided). When the paged party answers the call, they are connected to you. You can then transfer the call to the calling party.

### Activating Deluxe Paging: answer-back by the paged party

#### 1. Go off-hook to get dial tone.

#### 2. Dial the answer-back feature access code.

You hear dial tone.

#### 3. Dial the extension number where the call is parked, or dial # if the call is parked on the extension you are using.

Music-on-Hold, if provided, is removed from the parked call, all parties associated with the parked call receive confirmation tone, and the answer-back and parked parties are connected.

### Unparking a Loudspeaker Paging Call

#### 1. Press the lighted Call Park button.

## Considerations

---

### Considerations for Loudspeaker Paging

- An LDN or DID call cannot be connected to the paging facility. However, the attendant can page and park an incoming call.
- Normally, a user who is busy on a single-line voice terminal hears a call-waiting tone. If that user is in the process of paging, a call-waiting tone is not heard.
- You cannot use a PagePac paging system for Code Calling Access with multizone paging. PagePac systems expect a 2-digit code to access a particular zone. The system, however, immediately plays the chime code once a connection is established.

## Considerations for Deluxe Paging

- An LDN or DID call cannot be connected to the paging facility. However, the attendant can page a user and park an incoming call.
- Remote users (such as Remote Access users and tie-trunk users) cannot use # to park calls on their own extensions.

## Interactions

---

### Interactions with Loudspeaker Paging

The following features cannot be used with Loudspeaker Paging:

- Attendant Conference
- Terminal Conference
- Data Call Setup
- Hold
- Ringback Queuing
- Transfer

### Interactions with Deluxe Paging

- Bridged Call Appearance

If a parked call includes a shared Terminating Extension Group, a shared PCOL, or a redirected call with a Temporary Bridged Appearance, the maximum number of off-hook parties on the call is five, instead of six. The sixth position is reserved for the answer-back call.
- Call Coverage

If a coverage call is parked by Deluxe Paging, the Temporary Bridged Appearance at the principal extension is maintained as long as the covering user remains off-hook or places the call on hold.
- Call Park

A call cannot be parked on more than one extension at a time.

More than one call cannot be parked at the same extension at a time.

Call Park provides common shared extensions for use by attendants or by voice-terminal users with console permissions. These extensions are not assigned to a voice terminal, but are stored in system translations and used to park a call. These extensions are useful when one party is paged at the request of another party. The calling party is parked by Deluxe Paging and the extension is announced. Common shared extensions should be assigned to the optional selector console in any hundreds group that the attendant can easily identify. The extension lamp identifies call parked or no call parked (instead of active or idle status).

## 4 Basic Features

### Loudspeaker Paging Access

Page 4-419

If the Call Park Time-out interval expires during Deluxe Paging, the call normally returns to the paging user. However, with Remote Access and Tie Trunk Access, the call returns to the attendant. If unanswered, the call follows the coverage path of the paging user.

#### ■ Call Pickup

If a Call Pickup call is parked by Deluxe Paging, the Temporary Bridged Appearance at the principal extension is maintained as long as the answering pickup-group member remains off-hook or places the call on hold.

#### ■ Call Waiting Termination

Normally, a user who is busy on a single-line voice terminal hears call-waiting tone when a new call arrives. If that user is in the process of paging, call-waiting tone is not heard.

#### ■ Code Calling Access

You cannot use a PagePac paging system for Code Calling Access with multizone paging. PagePac systems expect a 2-digit code to access a particular zone. The system, however, immediately plays the chime code once a connection is established.

#### ■ Conference — Attendant

The maximum number of conferees on a parked Deluxe Paging call is five. The sixth conferee position is reserved for the answer-back call.

A Deluxe paging call cannot be conferenced unless a party was placed on hold and parked with the call. This is because paging equipment cannot be placed on hold.

#### ■ Conference — Terminal

Multiappearance voice terminals can have up to 5 conferees on a parked Deluxe Paging call. The sixth conferee position is reserved for the answer-back call.

Single-line voice terminals can have up to 2 conferees on a parked Deluxe Paging call.

A Deluxe paging call cannot be conferenced unless a party was placed on hold and parked with the call. This is because paging equipment cannot be placed on hold.

#### ■ Data Call Setup

If the Data button has been pressed for modem pooling, access to Deluxe paging is denied.

#### ■ Data Privacy

If a call, with Data Privacy activated, is parked by Deluxe Paging, Data Privacy for that call is automatically deactivated.

## 4 Basic Features

### Loudspeaker Paging Access

Page 4-420

- Hold

Deluxe Paging facilities cannot be placed on hold.
- Hunt Groups

If a hunt-group member parks a call using Deluxe Paging, the call is parked on the member's own extension, not the hunt-group extension.
- Leave Word Calling

If a user parks a call for his or her extension with the Conference button, any parking or parked parties cannot activate LWC because that party cannot be uniquely identified.
- Manual Originating Line Service

Users assigned Manual Originating Line Service cannot access Deluxe Paging.
- Music-on-Hold Access

Music-on-Hold, if provided, is connected to the parked party when only one conferee is left on the parked call. Music-on-Hold is not connected to a parked call with more than one conferee.
- Multiple LDNs

An LDN call cannot be connected to a Deluxe Paging facility.
- Night Service

If a night-station user parks a Night Service call with Deluxe Paging, the call is parked on the night station's primary extension.
- Personal Central Office Line

If a PCOL call is parked by Deluxe Paging, the Temporary Bridged Appearance of the call is maintained at the PCOL extension until the call is disconnected.
- Remote Access

Remote Access users can access Deluxe Paging unless they are restricted by COR from doing so.
- Ringback Queuing

Ringback Queuing is not provided for Deluxe Paging.
- Terminating Extension Group

If a TEG member parks a call using Deluxe Paging, the call is parked on the member's own individual extension not the TEG extension. You cannot park calls on a TEG extension by dialing the extension as a call-park destination.

**4 Basic Features**

*Loudspeaker Paging Access*

*Page 4-421*

- **Transfer**

A Deluxe paging call cannot be transferred unless a party was placed on hold and parked with the call. The reason for this is that paging equipment cannot be placed on hold.

## Malicious Call Trace

---

Malicious Call Trace (MCT) allows you to trace malicious calls. MCT allows you to define a group of terminal users who can notify others in the group when they receive a malicious call. These users then can retrieve information related to the call. Using this information, you can identify the malicious call source or provide information to personnel at an adjacent switch to complete the trace. MCT also allows you to record the malicious call.

You allow users in the group to activate MCT and/or to control malicious call trace. The controlling terminal user, or controller, receives the information that MCT collects on the call.

### How to administer MCT

---

#### Required forms

| Form  | Field   | Page  |
|---|---|---|
| Class of Restriction                                  | ■ Access to MCT   | <a href="#">5-72</a>  |
| Station   | ■ Feature Button Assignments<br>— mct-act (activate)<br>— mct-contr (control)             | <a href="#">6-14</a>  |
| Feature-Related System Parameters                     | ■ Apply MCT Warning Tone<br>■ MCT Voice Recorder Trunk Group                              | <a href="#">5-123</a>   |
| Feature Access Code (FAC)                             | ■ Malicious Call Trace Activation<br>■ Malicious Call Trace Deactivation                  | <a href="#">5-113</a>   |
| Attendant Console                                     | ■ Feature Button Assignments  | <a href="#">5-35</a>  |
| Extensions Administered to have an MCT-Control Button | ■ Extensions  | <a href="#">5-108</a>   |
| Trunk Group   | ■ MCT Voice Recorder fields:<br>— Group Type (CPE)<br>— TAC<br>— Group Member Assignments | <a href="#">7-175</a><br><a href="#">7-175</a><br><a href="#">7-177</a> |

## ISDN MCT Notification

The following describes how to administer the ISDN MCT notification for an ISDN trunk group (public-ntwrk, tandem, tie, or access).

### Required Forms for ISDN-PRI

| Form                              | Field              | Page                  |
|-----------------------------------|--------------------|-----------------------|
| System-Parameter Customer-Options | ■ ISDN-PRI         | <a href="#">5-277</a> |
| DS1 Circuit Pack                  | ■ Country Protocol | <a href="#">7-79</a>  |
|                                   | ■ Protocol Version |                       |
|                                   | ■ Peer Protocol    |                       |

Display the System-Parameter Customer-Options form and ensure that ISDN is enabled. One of the following must be set on the DS1 form:

- If the DS1 is connected to the public network in Australia, set `Country Protocol` field to **2**.
- For a private network of DEFINITY systems, set `Country Protocol` to **1** and `Protocol Version` to **a**. This is recommended if DCS features are used in the private network.
- For a private network of DEFINITY systems, set `Peer Protocol` to **q-sig**. (`Peer Protocol` appears on the DS1 form when `Signaling Mode` field is **isdn-pri**, `Connect` field is **pbx**, and `Interface` field is **peer-master** or **peer-slave**.)

### Required Forms for ISDN-BRI

| Form                              | Field             | Page                  |
|-----------------------------------|-------------------|-----------------------|
| System-Parameter Customer-Options | ■ ISDN-BRI Trunks | <a href="#">5-277</a> |
| ISDN-BRI Trunk Circuit Pack       | ■ Interface       | <a href="#">7-79</a>  |

Display the System-Parameter Customer-Options form and ensure that ISDN is enabled. One of the following must be set on the ISDN-BRI Trunk Circuit Pack form:

- If the ISDN-BRI is connected to the public network in Australia, set `Country Protocol` field to **2**.
- For a private network of DEFINITY systems, set `Interface` to **peer-master** or **peer-slave**.

## Detailed description

---

### MCT Voice Recorder

The MCT Voice Recorder is any type of audio recorder (for example, a standard audio cassette player) that you can control via the DEFINITY TN763 Auxiliary Trunk board. To record the call, manually place the MCT Voice Recorder in "Record" mode. The station user then activates the MCT feature which applies power to the recorder (via the connected Auxiliary Trunk's control signal interface).

### Activating MCT

To activate MCT while on an active malicious call, perform one of the following:

- Push an MCT-Activate feature button
- Place the call on hold, get a second call appearance, and dial an MCT-Activate Feature Access Code (FAC). After the dial tone, the user then dials their own extension, presses #, or waits for a 10-second timeout.
- Signal another user in the defined group to activate MCT. The co-worker activates MCT, waits for the dial tone, and dials the call recipient's extension.
- Inform a controller, who can request that another switch continue tracing the call.

The switches must be tandemed. The controller on the first switch supplies the trunk member port id to be traced. The controller on the second switch activates MCT and presses \*, followed by the trunk port id. The letters A through E of a port id are entered as 1 through 5 on the station keypad. For example, trunk port id 01C0401 would be entered as 0130401.

Once MCT is activated, information on the call is collected and alerts users in the group. The alert is not a call, so it is not affected by queues at the user's terminal. If an MCT Voice Recorder is connected, it begins recording the conversation.

#### NOTE:

Any Bridging, Conference, or Intrusion tone connected to parties on the connection are temporarily removed while the MCT Voice Recorder connects.

### Controlling MCT

The first controlling terminal to respond to an MCT alert becomes the controller for the call. Alerting on any other controlling terminals stops.



During alerting, the controller's display shows the message "MALICIOUS CALL TRACE REQUEST." While this message displays, no information on incoming calls displays.

When the controller pushes the MCT-Control button, information displays identifying the called party. When the controller pushes the button again the remaining MCT information displays, as the following example shows:

**Page 1 "MALICIOUS CALL TRACE REQUEST"**

**Page 2 "MCT activated by: 1002 for: 51001"**

**Page 3 "original call redirected from: 52001"**

**Page 4 "voice recorder port: 01C0104:"**

**Page 5 "party2: 01C1505 <PORT ID>" or "party2: 01C1505 <ISDN PORT ID>"**

**Page 6 "party3: 52001 <EXTENSION>:" or "party3: 52001 <ISDN PORT ID>"**

**Page 7 "END OF TRACE INFORMATION"**

MCT collects and displays three types of information, calling information as follows:

- If the call originated inside the system or on the same node within a DCS network, the calling number displays.
- If the call originates outside the system and an ISDN calling number identification is available on the incoming trunk, then the calling number displays. Otherwise, the incoming trunk-equipment location displays. In this case, the user must call the connecting switch.

For all calls, the system displays the called number, the activating number, whether the call is active, and identification of any other parties on the call.

## Deactivating MCT

The controller deactivates MCT by dialing the MCT-Deactivate FAC. Deactivation frees resources involved in the trace that were blocked. When all parties hang up, the MCT Voice Recorder disconnects.

## Considerations

---

- Trunks involved in MCT are blocked from dropping to facilitate tracing. Terminals involved in a malicious call are not blocked from dropping.
- Except for Emergency Access to the Attendant, features that normally display information do not do so on a controlling terminal. Otherwise, these features function normally until MCT deactivates.

## 4 Basic Features

### Malicious Call Trace

Page 4-426

- Do not use FACs to activate MCT because the process takes users too long.
- Visually Impaired Attendant Service (VIAS) voices-out display information for MCT activation, but not for MCT control.
- MCT information on an active malicious call is lost during a switch failure.
- When directing a trace to an adjacent switch, consider the following:
  - The malicious caller may hear a warning tone as a result of the intrusion.
  - You may lose continuity on the trace because the person activating MCT on the second switch may not be the MCT controller.
- If a malicious call comes in on a non-ISDN trunk, the controller needs the telephone number for the connecting switch and a cross-reference of system-trunk port numbers (including DS1 channel number, if appropriate) not the trunk equipment locations at the connecting switch. Be sure that they have this information.
- The following are the system initiated operations for MCT:
  - Conversation Recording — After the user activates MCT, the system attaches a MCT Voice Recorder, if available, to record the conversation, if available.
  - Historical Recording — After the user activates MCT, the system records the MCT-information that you can subsequently retrieve via the MCT History Administration form.

## Interactions

- Bridged Appearance — Temporary

If a controller activates a trace, the original called party can bridge on to the call.
- Bridged Call Appearance

If a user at a primary extension receives an indication call, then a station with a bridged call appearance of this extension can bridge on to the call. For an MCT-Activate button push, if the currently active extension is a bridged appearance, the system records the primary extension as the MCT recipient.

For an MCT-Activate FAC, the user dials the number of the terminal with the bridged call appearance that is actually on the call, instead of the bridged number. However, the system logs the primary extension as the recipient. Likewise, for self-originated MCT activations via FAC, the system logs the primary extension as the MCT recipient provided that the recently held appearance is a bridged call appearance. When you activate MCT for yourself, dial # or wait for interdigit timeout.

## 4 Basic Features

### *Malicious Call Trace*

Page 4-427

- Call Waiting

A call cannot wait on the line of a malicious call recipient when MCT is activated. Instead, the MCT recipient's line appears busy.
- Conference

A user can use conferencing to place a malicious caller on hold. The user can initiate conferencing and enter the MCT-Activate FAC, then stop conferencing and return to the malicious caller's appearance.

MCT-Activate can be generated for a member of a conference and is not affected by the number of parties on the conference.
- Centralized Attendant Service

MCT-Activate, MCT-Control, and MCT-Deactivate must be performed by terminals within the same PBX.
- DCS

If a voice terminal in a DCS network is involved in a malicious call, the extension is recorded and displayed with the MCT information. MCT notification passes over ISDN-PRI DCS trunks but MCT-Activate, MCT-Control, and MCT-Deactivate must be performed by terminals within the same DCS node.
- Emergency Access to the Attendant

Ordinarily, during MCT-Control no other feature can access the controlling terminal's display. However, MCT gives up control of the display until the Emergency Access call has completed.
- Individual Attendant Access

An attendant can receive an MCT alert to their individual attendant access extension, if the console is not busy. However, information is not displayed.
- ISDN

ISDN notification of an MCT activation takes place if either the originator of the call is an ISDN trunk group with Country Protocol 2 or any trunk on the call is an ISDN private network trunk with Country Protocol 1 and Protocol Version "a" or Peer Protocol q-sig. When the ISDN trunk group is Country Protocol 2, notification is sent only to the public network.
- Make-Busy/Position-Busy/Send All Calls

The switch attempts to activate Make-Busy or Position-Busy for stations or consoles that activate MCT-Control. If a user has a Send All Calls (SAC) button administered, then SAC activates when the user activates MCT-Control. When MCT is deactivated, the station resets to its original state.
- Music-On-Hold

## 4 Basic Features

### *Malicious Call Trace*

Page 4-428

If an agent places a malicious call on hold that is being recorded and the call goes to music-on-hold, the music-on-hold port and the MCT Voice Recorder port can lock. In this case, the MCT Voice Recorder continues to record the music-on-hold and is unavailable for recording subsequent malicious calls. You must perform a busy-out/release on the MCT Voice Recorder port to drop the connection.

- Priority Calling

A priority call to an MCT recipient is denied.

- QSIG Global Networking

MCT notification passes over the following ISDN QSIG trunk groups: tandem, tie, access, and DMI-BOS. QSIG supplementary services name and number ID provide a malicious caller's name and telephone number.

- R2 Multi-Frequency Code

MCT does not use R2 Multi-Frequency Code (MFC) signaling.

- Transfer

If a user transfers a malicious call, the MCT information displayed on the controlling terminal identifies the transferring party as the MCT recipient.

A user transfers a malicious caller to hold. The user initiates a Transfer, receives the second dial tone, enters the MCT-Activate FAC, then halts the remainder of the Transfer operation and returns to the malicious caller's appearance.

- Trunk Access Code

To activate MCT for a Trunk Access Code (TAC), a user must have an MCT-Control button administered. The user hears a dial tone and enters the trunk-member number for the trunk group that the TAC identified. The user then becomes the MCT controller for a call involving the identified trunk member. This TAC operation is useful when users need to trace a call that has tandemed through their switch to terminate on another switch.

- Trunk Groups

If a Personal Central Office Line (PCOL) is involved in an MCT, then the switch may hold up the trunk until the MCT deactivates.

## Manual Message Waiting

---

Manual Message Waiting enables multiappearance voice-terminal users to press a designated button on their own terminals and light the Manual Message Waiting button lamp at another multiappearance voice terminal.

### How to administer Manual Message Waiting

---

#### Required Forms

---

| Form                      | Field   | Page                 |
|---------------------------|---|----------------------|
| Station (multiappearance) | ■ Button/Feature Button Assignments<br>— man-msg-wt | <a href="#">6-14</a> |

---

### Detailed description

---

Press the Manual Message Waiting button to light the lamp on both the originating and receiving voice-terminals. Either terminal user can cause the lamp to go dark by pressing the button.

### Considerations

---

This feature can be administered only to pairs of voice terminals such as a secretary and an executive. The secretary might press the designated button to signal the executive that a call needs answering. The executive might press the button to indicate `Do Not Disturb` or `Not Available` to the secretary. (The button can be marked to reflect the intended use.)

### Interactions

---

None.

## Manual Originating Line Service

---

Manual Originating Line Service connects single-line voice-terminal users to the attendant automatically when a user lifts the handset.

### How to administer Manual Originating Line Service

---

#### Required Forms

---

| Form                     | Field                                 | Page                 |
|--------------------------|---------------------------------------|----------------------|
| Abbreviated Dialing List | ■ Dial Code (attendant)               |                      |
| — System List            |                                       | <a href="#">5-11</a> |
| — Group List             |                                       | <a href="#">5-5</a>  |
| — Personal List          |                                       | <a href="#">5-8</a>  |
| Station (single-line)    | ■ Abbreviated Dialing List 1, 2, or 3 | <a href="#">6-28</a> |
|                          | ■ Hot Line Destination AD List        |                      |

---

#### Detailed description

---

When a voice-terminal user lifts the handset, the system automatically routes the call to the attendant using Hot Line Service. The attendant code is stored in an Abbreviated Dialing List.

#### Considerations

---

- Use Manual Originating Line Service when all call originations are screened by the attendant. The user lifts the handset and is connected to the attendant.
- Call reception is not affected. A user can receive calls allowed by the assigned Class of Restriction (COR).
- Assign Manual Originating Line Service to any number of single-line voice terminals.

## Interactions

---

- Hotline Service

A Manual Originating Line Service call is a hotline service call to the attendant. A voice-terminal user cannot activate features that require dialing.

- Night Service

When Night Service is activated, the Manual Originating Line Service call is redirected.

## Manual Signaling

---

Manual Signaling allows voice-terminal users to signal other voice-terminal users. When a voice-terminal user presses the Manual Signaling button:

- The status lamp at the originating voice terminal lights for 2 seconds.
- The receiving voice-terminal user hears a 2-second burst of tone.

Manual Signaling is denied if the receiving voice terminal is already being alerted with an incoming call. The Manual Signaling button lamp at the originating voice terminal flutters briefly to indicate the denial.

### NOTE:

A Manual Signaling button cannot point to a Vector Directory Number.

## How to administer Manual Signaling

---

### Required forms

---

| Form                      | Field  | Page                 |
|---------------------------|--|----------------------|
| Station (multiappearance) | ■ Button/Feature Button Assignments<br>— signal (Ext: ___) | <a href="#">6-14</a> |

---

## Considerations

---

- The sender and the receiver should agree on the meaning of the signal.

## Interactions

---

- Data Modules

If you administer a Manual Signaling button with a data module's extension, attempts to activate the button result in denial.



## Messaging Server Interface

---

*This product is not supported as part of Lucent's service support agreements for DEFINITY ECS R6 and later.* Messaging Server (MS) interface provides MS-based features to the system such as Directory Service, Message Center Service, and Unified Messaging Services such as Electronic Documentation Communications, UNIX system mail, Office Telesystem, and DCS Centralized Messaging.

The MS interface consists of a control link between the DEFINITY and the MS and includes a hunt group of MS agents that takes messages. The control link transmits extra information relevant to each MS agent-handled call for the following services:

- Message Center Service — When agents receive (or drop) calls to leave or retrieve messages.
- Leave Word Calling — When users leave simple messages to call back or retrieves these call-back messages without MS agent intervention.
- Automatic Message Waiting lamp — When users manipulate message waiting lamps on stations.
- Clock Synchronization — Used to ensure that the MS clock is synchronized with the DEFINITYECS clock.

### How to administer MS interface

---

How you administer the MS interface depends on which type of DEFINITY you have.

**Table 4-82. Required forms for R5r only**

| Form                        | Field                   | Page                  |
|-----------------------------|-------------------------|-----------------------|
| Packet Gateway circuit pack | ■ All                   | <a href="#">5-246</a> |
| Data Module                 |                         | <a href="#">6-226</a> |
| — X.25                      | ■ All                   | <a href="#">6-249</a> |
| — PDM/TDM                   | ■ All                   | <a href="#">6-243</a> |
| Interface Links             | ■ All (for one MS link) | <a href="#">5-179</a> |

*Continued on next page*

**Table 4-82. Required forms for R5r only — Continued**

| Form   | Field                                      | Page                            |
|--|--|---------------------------------|
| Processor Channel Assignments for the following applications | ■ All                                      | <a href="#">5-248</a><br>(R5r)  |
| — msamsc   |  | <a href="#">5-252</a><br>(R5si) |
| — msahlwc  |  |                                 |
| — msallwc  |  |                                 |
| — msaamwl  |  |                                 |
| — msackk   |  |                                 |
| Feature-Related System Parameters                            | ■ Messaging Server Adjunct (MSA) Connected | <a href="#">5-123</a>           |

**Required forms for R5si**

| Form   | Field                                      | Page  |
|--|--|---|
| Data Module  |  | <a href="#">6-226</a>                                       |
| — Processor Interface Data Module                            | ■ All                                      | <a href="#">6-246</a>                                       |
| — Netcon Data Module   | ■ All                                      | <a href="#">6-245</a>                                       |
| — PDM/TDM  | ■ All                                      | <a href="#">6-243</a>                                       |
| Processor Channel Assignments for the following applications | ■ All                                      | <a href="#">5-248</a> (R5r)<br><a href="#">5-252</a> (R5si) |
| — msamsc   |  |   |
| — msahlwc  |  |   |
| — msallwc  |  |   |
| — msaamwl  |  |   |
| — msackk   |  |   |
| Interface Links  | ■ All (for one MS link)                    | <a href="#">5-179</a>                                       |
| Feature-Related System Parameters                            | ■ Messaging Server Adjunct (MSA) Connected | <a href="#">5-123</a>                                       |

**Required forms for MS agent hunt group**

| Form       | Field   | Page                  |
|------------|---|-----------------------|
| Hunt Group | <ul style="list-style-type: none"> <li>■ All</li> </ul> | <a href="#">5-158</a> |

**Required forms to give MS service to a station**

| Form          | Field   | Page                 |
|---------------|---|----------------------|
| Station       | <ul style="list-style-type: none"> <li>■ Messaging Server Name</li> <li>■ LWC Reception</li> <li>■ Coverage Path</li> </ul> | <a href="#">6-4</a>  |
| Coverage Path | <ul style="list-style-type: none"> <li>■ Coverage Point</li> </ul>  | <a href="#">5-94</a> |

**Detailed description**

[Figure 4-4](#) shows an MS interface to the system. You can provide SCI link connectivity (control path) via either an MPDM (distance between the system and Messaging Server less than 5000 feet or 1500 meters) or LADs and an associated MTDM (distance greater than 5000 feet or 1500 meters). The EIA connectivity (data path) can be implemented via one of the three options shown.

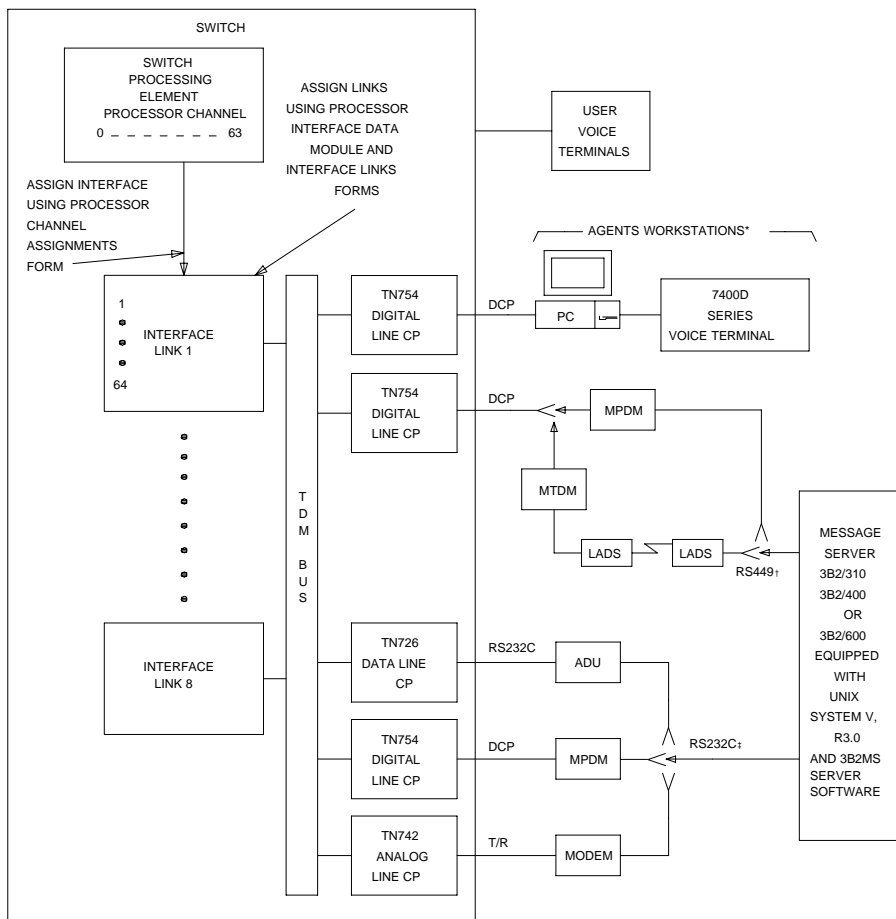

\* PC EQUIPPED WITH 3B2 MS STATION SOFTWARE.  
 SEE PC/PBX CONNECTIONS FOR ASSOCIATED  
 IMPLEMENTATION INSTRUCTIONS

† SCI LINK CONNECTIVITY (CONTROL PATH)  
 FOR DISTANCES GREATER THAN 5000 FEET,  
 USE LADS AND MTDM CONNECTION.

‡ EIA CONNECTIVITY (DATA PATHS)

Figure 4-4. Typical Messaging Server Interface Connections

## **Considerations**

---

- You must set a coverage point on the Coverage Path form to include the hunt group number of the MS agent hunt group.

## **Interactions**

---

None.

## Multifrequency Signaling

Multifrequency (MF) signaling is a form of address signaling used between switches and the central office (CO). It is similar to dual-tone multifrequency (DTMF) signaling in that tones convey the dialed number.

With MF signaling, the signal is typically a combination of two frequencies from a group of 5 or 6 frequencies (2/5 or 2/6). The origination switch and destination switch exchange tones that have specific meanings according to the MF protocol.

### How to administer MF Signaling

#### Required forms

| Form   | Field  | Page                  |
|--|--|-----------------------|
| Multifrequency-Signaling-Related System-Parameters | ■ All  | <a href="#">5-228</a> |
| Trunk Group  |  | <a href="#">7-115</a> |
| — CO   | ■ Outgoing Dial Type                         | <a href="#">7-168</a> |
| — DID  | ■ Incoming Dial Type                         | <a href="#">7-178</a> |
| — DIOD   | ■ Outgoing Dial Type                         | <a href="#">7-183</a> |
| — Tie  | ■ Incoming Dial Type<br>■ Outgoing Dial Type | <a href="#">7-262</a> |
| AAR and ARS Digit Analysis Table                   | ■ ANI  | <a href="#">8-55</a>  |
| AAR and ARS Digit Conversion Table                 | ■ ANI  | <a href="#">8-63</a>  |
| Class of Restriction                               | ■ Category for MFC ANI                       | <a href="#">5-72</a>  |
| System-Parameters Customer-Options                 | ■ G3 Version<br>■ Multifrequency Signaling   | <a href="#">5-228</a> |

To receive Russian incoming ANI:

- On the DID or DIOD trunk group form, set `Country` to **15** and `Protocol Type` to **inloc**.
- On AAR and ARS Digit Analysis Table, set `ANI Req` field to **y** or on AAR and ARS Digit Conversion Table, set `ANI Req` field to **y**.

## Detailed description

---

DEFINITY ECS supports two frequency groups:

- R2-multifrequency compelled signaling (R2-MFC) frequency
- R1 frequency (for Spain and Russia)

R2-MFC is a version of MFC recommended by the Consultative Committee for International Telephone and Telegraph (CCITT). It provides signaling between a CO and a switch over analog or digital CO, DID, or DIOD trunks. It also provides signaling between 2 DEFINITY switches.

DEFINITY ECS provides MF signaling that complies with CCITT regulations and national regulations for specific countries. It provides these types of MF signaling: Multifrequency Espana (MFE), MF Shuttle, and multifrequency compelled (R2-MFC). These protocols signal the called number, the calling party's number (automatic number identification (ANI)), and information about the type of call or type of caller (category).

DEFINITY ECS allows prefix digits for ANI sent on outgoing calls to be defined per PBX or per the originator's class of restriction.

If a call is a tandem call and the incoming and outgoing trunk use different protocols, the switch makes no attempt to convert between the various protocol's meanings for category. Instead,

- the PBX uses the incoming trunk's COR assigned category if the outgoing trunk is Russian or R2-MFC, and
- the PBX uses ARS call types if the outgoing trunk is MFE.

DEFINITY ECS provides the incoming ANI to all features on the switch that need to identify the calling party.

## MFE

MFE, for Country code 11 (Spain), uses R1 frequency and compelled signaling. It is available on CO and DID trunk groups. There are four kinds of MFE signaling:

- Public 2/5
- Public 2/6
- Ibercom 2/5
- Ibercom 2/6

## MF Shuttle

MF shuttle signaling, for country code 15 (Russia), uses R1 frequency and noncompelled signaling. With MF shuttle signaling, it is possible to change to decadic rotary pulse in the middle of address signal exchange. MF shuttle signaling is available on CO, DID, and DIOD trunk groups.

## 4 Basic Features

### Multifrequency Signaling

Page 4-440

Also, automatic number identification (ANI) transmission, for Country code 15, uses a gapless R1 MF signal and is completed within 800ms. This is available on an outgoing CO trunk group.

## R2-MFC

R2-MFC, with DEFINITY ECS, permits each country to define the meanings of the R2 frequency combinations. Specific frequency combinations for different countries are described in the *DEFINITY ECS Application Notes for Type Approval*.

## R2-MFC Considerations

- Both non-group II signaling and group II signaling are supported on incoming MF signaling calls. The group II signaling protocol has an extra signal that provides caller-category information. Only group II signaling is supported on outgoing MF signaling calls.
- MF signaling also can be used in tandem trunk groups. After address signals are collected from an incoming group II MF signaling call, the call can route to a group II MF signaling trunk.
- Both incoming and outgoing MF signaling calls support ANI. The terminal displays ANI information and the Call Detail Recording (CDR) record records it.
- When DEFINITY ECS uses an open numbering plan, the end-of-dial signal must be defined in the incoming Group I signal administration. After sending all address digits, the CO sends the end-of-dial signal to DEFINITY ECS.
- If DEFINITY ECS makes an outgoing call to the CO that uses an open numbering plan, the CO should send the signal A.1 to DEFINITY ECS after sending the last address digit to the CO. Then, the CO should timeout and send a pulsed signal A.3 to DEFINITY ECS requesting the Group II signal.

## Guidelines for administering MF signaling

To administer MF signaling, first you identify the origination switch and the destination switch. (The switch making the call is the origination switch; the switch answering the call is the destination switch.)

- The origination switch creates *forward* signals, classified as group I and group II signals.
- The destination switch creates *backward* signals, classified as group A and group B signals.

Group I and group A signals comprise the basic signaling for the dialed number. More elaborate signaling requires Group II and group B signals. Signal meanings and timer values can be administered.



The sequence below shows a typical interaction between the origination (forward group I and group II signals) and destination switch (backward group A and group B signals).

| Forward  |           | Backward    |
|----------|-----------|-------------|
| Group I  | digit --> |             |
|          | <-- A.1   | Group A     |
|          | digit --> |             |
|          | <-- A.1   |             |
|          | digit --> |             |
|          | <-- A.1   |             |
|          | digit --> |             |
|          | <-- A.1   |             |
|          | digit --> |             |
|          | <-- A.3   | End of dial |
| Group II | II.2 -->  |             |
|          | <-- B.x   | Group B     |

Second, you assign the correlation between signal codes and their meanings.

1. Assign a code to every message. The code consists of a group category, like group II or A, and a number.
  - For example, you might assign code A.1 to the message “next-digit.”
2. Assign a signal to each identifying code.
  - In every country, the frequencies (levels may differ by country) assigned to the identifying codes are the same. However, the messages assigned to the identifying codes may be different.

For example, in Switzerland the B.6 code and its associated signal convey the *free* message, while in Thailand, *free* is conveyed by the B.1 code and its associated signal. But in both Switzerland and Thailand, the frequency associated with the B.1 code is the same.

As another example, you might assign the signal “busy” to the B.1 code.

## Interactions

---

- ASAI
  - ANI collected from incoming R2-MFC signaling can be used with ASAI.

## 4 Basic Features

### Multifrequency Signaling

Page 4-442

- Abbreviated Dialing

Although calls dialed automatically from an abbreviated dialing privileged list complete without class of restriction (COR) checking, ANI prefix and ANI truncation still apply.

- Attendant Console

If the attendant assists or extends a call for a station via Straightforward Outward Completion and Through Dialing, and if the attendant has not yet released the call when the request for ANI comes in from the far end, the attendant's COR is used to select the ANI for the call. If the attendant has already released the call when the request for ANI comes in from the far end, the attendant's COR is used to select the ANI for the call.

- Authorization Codes

The COR of the authorization code as administered on the authorization-code form is not used for ANI prefix determination, even if the originating endpoint enters an authorization code before call processing for an outgoing call seizes an outgoing trunk. If the originating endpoint is an extension, the extension's ANI is used. If the originating endpoint is an incoming trunk, the ANI for PBX is used.

- Bridging

The ANI of a voice terminal's primary extension also applies to calls originated from a bridged call appearance of that extension on another terminal. ANI prefix and ANI truncation will still apply to the primary extension number of bridged call appearances.

- Call Detail Recording

CDR records ANI collected from incoming MF signaling.

**For India** MFC, on incoming calls, ANI digits may be appended with zeroes if the actual ANI digits are less than the administered ANI-length; in those cases, the zero-digits appear on CDR.

- Call Redirection

A call is redirected if any of the following are active: Call Forwarding, Call Coverage, Send All Calls, or Night Service.

- Call Vectoring

Call Vectoring can now use ANI collected from incoming MFC signaling.

The ANI of a call vector is not used when a call vectoring route-to-command routes a call over an outgoing trunk. Instead, the ANI of the originating party is sent.

- DID No Answer Timer

DID No Answer Timer is applied to MF signaling DID calls.

- Distributed Communications System (DCS)

In a DCS arrangement, as shown below,

**4 Basic Features**

*Multifrequency Signaling*

set ----- PBX\_A -----PBX\_B ----- CO  
DCS trunk                      MF trunk

the ANI sent to the CO is determined by the ANI for PBX on PBX\_B, but the category sent to the CO is determined by the *Category for MF ANI* field on the Class of Restriction form for the incoming DCS trunk or by the type of call.

- **Expert Agent Select (EAS)**

For ANI, the EAS agent’s login extension number and COR overrides the extension number and COR of the physical terminal where the agent is logged in. ANI prefix and ANI truncation apply to logged in EAS agents.
- **Hunt Groups and Automatic Call Distribution (ACD) Splits**

For ANI, a physical terminal’s extension number and COR overrides the extension number and COR of the hunt group or ACD split that the terminal is a member of or logged into. ANI prefix and ANI truncation apply to terminals that are members of hunt groups or logged into ACD splits.
- **Multimedia Call Handling (MMCH)**

For call origination, multimedia complexes use the COR assigned to their voice terminals. ANI prefix and ANI truncation will apply to the voice terminals assigned to multimedia complexes.
- **Off-Net Call Coverage or Call Forwarding**

If the originating endpoint is an extension, the extension’s ANI is used. If the originating endpoint is an incoming trunk that can supply ANI, the ANI received from the incoming trunk is used. If the originating endpoint is neither of the above, the ANI for PBX is used.
- **Personal Station Access (PSA)**

For ANI, the PSA extension number and COR overrides the extension number and COR of the physical terminal where the PSA extension number is associated. ANI prefix and ANI truncation will apply to associated PSA extension numbers.
- **Remote Access**

The COR of a remote access barrier code is not used for ANI prefix determination when the originating end point dials a remote access extension and then places a call. If the originating endpoint is an extension, the extension’s ANI is used. If the originating endpoint is an incoming trunk, the ANI for PBX is used.

## 4 Basic Features

### Multifrequency Signaling

Page 4-444

- Station Set Displays

When no ANI is possible, if station sets are equipped with display option, they do not display the ANI digits. Instead, the trunk group name displays. When ANI is possible, ANI displays on the station set.

**For India Only.** If ANI digits are padded with “zero,” then zeroes also are displayed along with ANI digits.

- Tandem / Offnet Calls

If ANI digits are received on incoming MFC calls, the ANI digits are sent to outgoing tandem/off-net calls.

**For Russia Only.** The ANI is requested on incoming trunks only when all the address digits have been collected. When the incoming trunk on a tandem call is a Russian incoming local trunk administered to collect ANI, the PBX collects all ANI digits before seizing the outgoing tandem trunk. This happens even if ARS is administered with a “min” value low enough that it would be possible to determine an outgoing route through digit analysis.

**For India Only.** On an outgoing tandem-call, the default operation is to send the ANI-Not-Available forward signal if ANI is not available from the incoming trunk. However, in order to support this operation, leave the `ANI for PBX` field blank, and define the ANI-Not-Available signal.

## Misoperation Handling

---

Misoperation Handling, used only in France and Italy, defines how calls are handled when a misoperation occurs. A misoperation can occur either:

- When a user with a call on hold goes on-hook before an operation completes. In some cases, going on-hook completes the operation, as in call transfer.
- When the system enters Night Service while attendant consoles have calls on hold.

You can alter standard Misoperation Handling to ensure that callers are not left on hold indefinitely with no way to reach someone for assistance or that callers are not dropped by the system.

### How to administer Misoperation Handling

---

Contact a Lucent representative for instructions on administering Misoperation Handling for use in France.

#### Required forms

| Form                                 | Field   | Page                  |
|--------------------------------------|---|-----------------------|
| Feature-Related<br>System Parameters | ■ Misoperation Alerting                         | <a href="#">5-123</a> |
|                                      | ■ Intercept Treatment on Failed Trunk Transfers |                       |

### Detailed description

---

Misoperation handling varies considerably, depending on how it is administered and what conditions are in effect when a call is placed on hold.

### Standard operation

Standard misoperation handling is in effect when you set the `Intercept Treatment on Failed Trunk Transfers` field to **y** and set `Misoperation Alerting` to **n**.

The type of voice terminal that is in use when the misoperation occurs (analog single-line or digital multiappearance) affects standard misoperation handling.

The following scenario describes a typical misoperation on an analog terminal.

1. While connected to an incoming external call, an analog-terminal user flashes with the intent of transferring the call to another terminal.
2. The user hears dial tone, dials an invalid extension, and hangs up.

3. A misoperation occurs. The analog-terminal user receives priority ringback indefinitely.

The following scenario describes a typical misoperation on a digital terminal.

1. While connected to an incoming external call, a digital-terminal user with a call on hold goes on-hook during another feature operation before completing the operation.
2. The user hears dial tone, dials an invalid extension, and hangs up.
3. A misoperation occurs unless going on-hook completes the operation (for example, call transfer). The held call remains on hold indefinitely with a flashing call-appearance lamp.

## Enhanced operation

Once you enable Misoperation Alerting, calls are handled depending upon the type of call placed on hold and the type of voice terminal (digital multiappearance, analog single-line, or attendant console) in use when the misoperation occurs. The following list describes the 3 call types that determine misoperation handling.

- Call Type 1 — An outgoing public-network call is classified as Type 1 when answer supervision is received or when the trunk group's Answer Supervision Timer expires, even if the trunk is still ringing. An incoming call is classified as Type 1 when it is answered.
- Call Type 2 — An incoming external-public-network call is classified as Type 2 before it is answered. A misoperation cannot occur with a Type 2 call because an unanswered incoming call cannot be placed on hold without first being answered.
- Call Type 3 — All internal calls, conference calls, and tie-trunk calls are classified as Type 3.

## Analog terminal misoperation

The following 2 scenarios describe typical misoperations on an analog terminal.

### Scenario 1.

1. While connected to an incoming external call (Type 1), an analog-terminal user flashes to transfer the call to another terminal.
2. The user hears dial tone, dials an invalid extension, then hears intercept tone.
3. When the user hangs up, the call re-alerts the user for 15 seconds and eventually routes to the attendant.

### Scenario 2.

1. While connected to an incoming external call (Type 1), an analog station user flashes to place the call on hold while calling another extension.
2. The user hears dial tone and dials the CAS Remote Hold/Answer Hold/unhold access code.
3. The user dials an extension and talks with the user at the extension and hangs up.
4. A misoperation occurs because the first call is still left on hold.
5. The terminal is alerted for 15 seconds and the call routes to an attendant.
6. If the first call is not answered before the timer expires, the call drops.

### Digital terminal misoperation

The following scenario describes a typical misoperation on a digital terminal.

1. While connected to an incoming external call (Type 1), a digital-terminal user places the call on hold to transfer the call to another terminal.
2. The user hears dial tone, dials an invalid extension, and hangs up.
3. A misoperation occurs. The call on hold rerings the terminal (not priority ringing) for the number of rings administered for call coverage.
4. The call then routes to the terminal's coverage path, which directs the call to an announcement and/or disconnects.

### Attendant console misoperation

A misoperation occurs on an attendant console with calls on hold only when the system enters Night Service.

1. The system enters Night Service with calls on hold at an attendant console.
2. All calls on hold re-alert (as if the Held-Call Timed-Reminder had expired).
3. When the calls start re-alerting, a timer starts. The timer is set to the value assigned in the `Alerting (sec)` field on the Console-Parameters form.
4. If the attendant does not answer the calls before the timer expires, calls route to the system Night Service destination. Calls that are not answered at the night service destination before the night-service-disconnect timer expires are dropped.

## Interactions

---

- Attendant Lockout  
Attendant Lockout is temporarily disabled on calls that re-alert the attendant console following a misoperation. This allows an attendant to answer the calls.
- Bridged Appearances  
Misoperation Alerting calls do not re-alert on bridged call appearances.
- Voice Response Integration  
Do not use Misoperations Handling with this feature if you are using analog boards with Conversant.



## Modem Pooling

Modem Pooling allows switched connections between digital-data endpoints (data modules) and analog-data endpoints via pods of acoustic-coupled modems. The analog-data endpoint is either a trunk or a line circuit.

### How to administer Modem Pooling

#### Required forms for Integrated Modem Pooling

| Form                      | Field                          | Page                  |
|---------------------------|--------------------------------|-----------------------|
| Modem Pool Group          | ■ All                          | <a href="#">5-223</a> |
| Feature Access Code (FAC) | ■ Data Origination Access Code | <a href="#">5-113</a> |
| Data Module (all)         | ■ All                          | <a href="#">6-226</a> |

#### Required forms for Combined Modem Pooling

| Form                      | Field                          | Page                  |
|---------------------------|--------------------------------|-----------------------|
| Modem Pool Group          | ■ All                          | <a href="#">5-223</a> |
| Feature Access Code (FAC) | ■ Data Origination Access Code | <a href="#">5-113</a> |

### Detailed description

Data transmission between a digital data endpoint and an analog endpoint requires conversion via a modem, because the DCP format used by the data module is not compatible with the modulated signals of an analog modem. A modem translates DCP format into modulated signals and vice versa.

Modem Pooling feature provides pools of integrated-conversion modems and combined-conversion modems.

Integrated-conversion modem pools have functionality integrated on the TN758 Pooled Modem circuit pack, providing two modems. Each one emulates a TDM cabled to a 212 modem. Integrated are modem pools not available in countries that use A-law companding.

Combined-conversion modem pools are TDMs cabled to any TDM-compatible modem. Combined-conversion modem pools can be used with all systems.

When the system needs a modem, it queries the digital-data module associated with the call to determine if the module's options are compatible with those supported by the modem pools. If the options are not compatible, the originating user receives intercept treatment. If the options are compatible, the system

obtains a modem from the appropriate pool. If a modem is not available, the user receives reorder treatment.

The system can detect the needs for a modem. Data calls from an analog-data endpoint require that the user indicate the need for a modem, because the system considers such calls to be voice calls. Users indicate this need by dialing the data-origination access code before dialing the digital-data endpoint.

The system provides a Hold Time parameter to specify the maximum time any modem can be held but not used (while a data call is in queue).

The integrated-conversion modems support the following options:

- Receiver responds to remote loop
- Loss of carrier disconnect
- Send space disconnect
- Receive space disconnect
- CF-CB common
- Speed, duplex, and synch (administered)

Combined-conversion modems support the following:

- IBM bisynchronous protocols typically used in 3270 and 2780/3780 applications. Both require 2400 or 4800 bps, half-duplex, synchronous transmission.
- Interactive IBM-TSO applications using 1200 bps, half-duplex, asynchronous transmissions
- DATAPHONE II switched-network modems supporting asynchronous and synchronous communications, and autobaud at 300, 1200, or 2400 bps
- The DEFINITY ECS operating at up to 19.2 kbps
- Different pools with different data-transmission characteristics

## Considerations

- On data calls between a data module and an analog-data endpoint, Return-to-Voice releases the modem and returns it to the pool. The voice-terminal user connects to the analog-data endpoint.
- For traffic purposes, the system accumulates data on modem-pooling calls separate from voice calls. Measurements on the pools also accumulate.
- When a voice-terminal user places a data call to a digital-data endpoint, does not transfer the call to another digital-data endpoint, and uses a modem or acoustically-coupled modem, the user dials the data-origination access code before dialing the distant endpoint.

- Modem Pooling is not restricted. Queuing for modems is not provided, although calls queued on a hunt group retain reserved modems.
- Avoid mixing modems from different vendors within a combined pool because such modems may differ in transmission characteristics.
- When you administer data-transmission characteristics (speed, duplex, and synchronization mode), they must be identical to the TDM and optional modem selections made by the customer.
- Each data call that uses Modem Pooling uses four time slots (not just two). As a result, heavy usage of Modem Pooling could affect TDM bus-blocking characteristics.
- Tandem switches do not insert a pooled modem. The originating switch inserts a pooled modem.

## Interactions

---

- Call Detail Recording  
Data call CDR records the use of modem pools on trunk calls.
- Data Call Setup  
Data calls to or from a TDM cannot use Modem Pooling.
- Data Privacy and Data Restriction  
The insertion of a modem pool does not turn off Data Privacy or Data Restriction.
- Data-Only Off-Premises Extensions  
Calls to or from a Data-Only Off-Premises Extension cannot use Modem Pooling, when this type of digital-data endpoint uses a TDM.
- DMI Trunks  
If you place a data call from a local analog-data endpoint to a DMI trunk, you must dial the data-origination access code to obtain a modem. Data calls on DMI trunks to local analog-data endpoints automatically obtain modems.
- DS1 Tie Trunk Service  
Connect modems used for Modem Pooling to AVD DS1 tie trunks via Data Terminal Dialing or by dialing the feature-access code for data origination.

## Multiappearance Preselection and Preference

---

Multiappearance Preselection and Preference selects the call appearances you use to connect to when you lift the handset.

### How to administer Multiappearance Preselection and Preference

---

You do not have to administer Preselection.

#### Required forms

---

| Form                      | Field                         | Page                 |
|---------------------------|-------------------------------|----------------------|
| Station (multiappearance) | ■ Idle Appearance Preference  | <a href="#">6-14</a> |
|                           | ■ Select Last Used Appearance |                      |

---

### Detailed description

---

Multiappearance Preselection and Preference provides multiappearance voice-terminal users with the following options for placing or answering calls on selected call appearances.

- Ringing Appearance Preference

When a user lifts the handset to answer a call, the system automatically connects them to the ringing call appearance. If there is more than one call, the user automatically connects to the oldest (first-in) ringing call appearance. The in-use (red) lamp tracks the ringing appearance and the answered appearance.

- Idle Appearance Preference

When a user lifts the handset to place a call, the system automatically connects them to an idle appearance even if an incoming call is ringing at another appearance. The in-use (red) lamp tracks an idle appearance when the user lifts the handset.

- Last Appearance Preference

When a user lifts the handset, they connect to the call appearance or bridged appearance last used for a call, unless an audibly ringing call on a different appearance caused the line selection to move. If the line selection moves, a call may be originated, answered, or unheld, depending on the state of that appearance.

- Preselection

Before lifting the handset to place or answer a call, the user can press a call appearance button or a feature button to select an appearance when the in-use lamp is dark. Preselection reenters a held call or activates a feature or the speakerphone if the voice terminal is so equipped.

Preselection overrides both Preference options. If the user does not lift the handset within 5 seconds after using Preselection, the selected appearance returns to idle.

You can assign a preselection feature button. For example, if a user presses an Abbreviated Dialing button, a call appearance is automatically selected. If the user lifts the handset within 5 seconds, the system automatically places the call.

Preference dictates whether a user connects to the ringing call appearance or to an idle call appearance. If there is no call, users automatically connect to an idle call appearance when they lift the handset, regardless of which Preference option is assigned.

## Considerations

---

- Multiappearance voice terminals can have from 2 to 10 call appearances. One of these call appearances is reserved for placing calls or for receiving a Priority Calling call. If a voice terminal has 2 call appearances and one of them is active, a nonpriority call cannot access the other call appearance, even if the call appearance is idle. The default number of call appearances is 3.
- The reserved call appearance is not a fixed-position button; it is just the last-idle call appearance. For example, if a voice terminal has 10 call appearances, any 9 can be in use, but the tenth (last) is reserved.
- All incoming and outgoing calls require a call appearance. There are no hidden or free call appearances. For example, when a call rings a call-pickup group member, another member normally presses the Call Pickup button to answer the call. However, pressing the button only selects a call appearance for the call, if available. If a call appearance is not available, the call cannot be picked up.
- Similarly, calls placed by using Facility Busy Indication also require a call appearance. In this case, the call cannot complete unless an idle call appearance is available. A Facility Busy Indication button on the called voice terminal provides a visual indication of the busy or idle status of another facility, but it does not provide a talking path.

## Interactions

---

- Automatic Incoming Call Display  
Incoming calls are not displayed if Idle Appearance Preference is activated.
- Call Coverage  
If you administer Cover All Calls as the redirection criterion for a voice terminal, administer Idle Appearance Preference for the terminal. The called party can then lift the handset without accidentally connecting to a call that should be screened.
- Integrated Services Digital Network — Basic Rate Interface  
When an ISDN-BRI terminal (with Select Last Used Appearance enabled) transfers a call while off-hook by using the handset, the user hears dial tone on the last-used call appearance. Users of other voice-terminal types hear silence in this case.

## Music-on-Hold Access

Music-on-Hold Access automatically provides music, silence, or tone to a caller. Providing music lets the caller know that the connection is still active. The following table shows what happens when you administer one of the options.

| Caller Status                             | Music | Silence | Tone |
|---|-------|---------|------|
| On hold                                   | yes   | no      | yes  |
| On a trunk call that is being transferred | yes   | yes     | no   |
| Parked                                    | yes   | no      | yes  |
| Waiting in queue                          | yes   | no      | yes  |

### ⇒ NOTE:

If you use equipment that rebroadcasts music or other copyrighted materials, you may be required to obtain a copyright license from or pay fees to a third party such as the American Society of Composers, Artists, and Producers (ASCAP) or Broadcast Music Incorporated (BMI).

## How to administer Music-on-Hold Access

### Required forms

| Form                              | Field   | Page                  |
|-----------------------------------|---|-----------------------|
| Feature-Related System Parameters | ■ Music/Tone On Hold                            | <a href="#">5-123</a> |
|                                   | ■ Music Port                                    |                       |
|                                   | ■ Music (or Silence) on Transferred Trunk Calls |                       |
| Music Sources                     | ■ All   | <a href="#">5-243</a> |
| CPE trunk group                   | ■ All   | <a href="#">7-174</a> |
| Class of Restriction              | ■ Hear System Music on Hold                     | <a href="#">5-72</a>  |

## Consideration

- If the `Tenant Partitioning` field on the System-Parameters Customer-Options form is set to **y**, you *cannot* administer Music/Tone on Hold on the Feature-Related System Parameters form; you must use the Music Sources form.
- Any number of calls can simultaneously connect to music.
- The system does not provide music to callers in a multiple-party connection who are in queue, on hold, or parked.

## Interactions

---

- Automatic Call Distribution

If you administer `Music/Tone on Hold` to provide music, the system provides the music after the ACD split delayed announcement.

- Data Privacy and Data Restriction

If a call with either Data Privacy or Data Restriction activated is placed on hold, `Music/Tone on Hold` access is withheld to prevent transmission of a musical tone that a connected data service might falsely interpret as a data transmission.

- Hunting

If you administer `Music/Tone on Hold` to provide music, the system provides the music after the DDC group or UCD group delayed announcement.



## Night Service

---

DEFINITY ECS provides the following Night Service features:

- Hunt Group Night Service
- Night Console Service
- Night Station Service
- Trunk Answer from Any Station
- Trunk Group Night Service

### Hunt Group Night Service

---

Hunt Group Night Service allows an attendant or a split supervisor to assign a hunt group or split to Night Service mode. All calls for the hunt group then are redirected to the hunt group's designated Night Service extension (NSE). When a user activates Hunt Group Night Service, the associated button lamp lights.

### How to administer Hunt Group Night Service

#### Required forms

| Form                         | Field  | Page                  |
|------------------------------|--|-----------------------|
| Station<br>(multiappearance) | ■ Button/Feature Button Assignments<br>— hunt-ns | <a href="#">6-14</a>  |
| Attendant Console            | ■ Feature Button Assignments<br>— hunt-ns        | <a href="#">5-35</a>  |
| Hunt Group                   | ■ Night Service Destination                      | <a href="#">5-158</a> |

### Night Console Service

---

Night Console Service directs all calls for primary and daytime attendant consoles to a night console. When a user activates Night Console Service, the Night Service button for each attendant lights and all attendant-seeking calls (and calls waiting) in the queue are directed to the night console.

To activate and deactivate this feature, the attendant typically presses the Night button on the principal attendant console or designated console.

## How to administer Night Console Service

### Required forms

| Form              | Field          | Page                 |
|-------------------|----------------|----------------------|
| Attendant Console | ■ Console Type | <a href="#">5-35</a> |

## Night Station Service

Night Station Service directs incoming calls for the attendant to designated extensions. Attendants can activate Night Station Service by pressing the Night button on the principle console if there is not an active night console. If the night station is busy, calls (including emergency attendant calls) receive busy tone. They do not queue for the attendant.

When Night Station Service is active, incoming calls to the attendant route as follows:

- DID Listed Directory Number (LDN) calls route to a designated DID-LDN night extension.
- Internal calls route to the DID-LDN night extension (unless you administer the system so only DID-LDN calls can route to the LDN night extension).
- Non-DID calls route to the night destination that you specify for the trunk group or for the individual trunk. If you do not specify a night destination, the calls route to the DID-LDN night extension.

You can assign a unique extension as the night destination for each incoming central-office, foreign-exchange, or 800-Service trunk group. Both the extension assigned as a trunk group's night destination and the DID-LDN night extension can be voice terminals or answering groups (such as DDC group, UCD group, or TEG).

## How to administer Night Station Service

### Required forms

| Form                     | Field                       | Page                  |
|--------------------------|-----------------------------|-----------------------|
| Listed Directory Numbers | ■ Night Destination         | <a href="#">5-207</a> |
| Trunk Groups (All)       | ■ Night Service             | <a href="#">7-115</a> |
| Hunt Group               | ■ Night Service Destination | <a href="#">5-158</a> |

*Continued on next page*

**Required forms — Continued**

| Form                      | Field   | Page                 |
|---------------------------|---|----------------------|
| Attendant Console         | <ul style="list-style-type: none"> <li>■ Feature Button Assignments                             <ul style="list-style-type: none"> <li>— hunt-ns</li> <li>— night-ser</li> <li>— trunk-ns</li> </ul> </li> </ul>        | <a href="#">5-35</a> |
| Station (multiappearance) | <ul style="list-style-type: none"> <li>■ Button/Feature Button Assignments                             <ul style="list-style-type: none"> <li>— night-ser</li> <li>— hunt-ns</li> <li>— trunk-ns</li> </ul> </li> </ul> | <a href="#">6-14</a> |

**Trunk Answer from Any Station**

Trunk Answer from Any Station (TAAS) allows voice-terminal users to answer all incoming calls to the attendant when the attendant is not on duty and when other voice terminals have not been designated to answer the calls. The incoming call activates a gong, bell, or chime and a voice-terminal user dials an access code to answer the call.

Users can activate TAAS if each of the following conditions is met:

- The attendant has pressed the Night button on the primary console or a user (if the switch has no attendant) pressed the Night Service button on the designated Night Service voice terminal.
- A night console is not assigned or is not operational.
- Night Station Service is not active.

**How to administer TAAS**

**Required forms**

| Form                      | Field  | Page                  |
|---------------------------|--|-----------------------|
| Trunk Groups (All)        | <ul style="list-style-type: none"> <li>■ Night Service (blank)</li> </ul>                | <a href="#">7-115</a> |
| Feature Access Code (FAC) | <ul style="list-style-type: none"> <li>■ Trunk Answer Any Station Access Code</li> </ul> | <a href="#">5-113</a> |
| Console-Parameters        | <ul style="list-style-type: none"> <li>■ Ext Alert Port (TAAS)</li> </ul>                | <a href="#">5-86</a>  |

## Trunk Group Night Service

Trunk Group Night Service allows an attendant or a designated Night Service voice-terminal user to assign one or all trunk groups to Night Service mode. When a user activates Night Service, trunk groups that are assigned a Trunk Group Night Service termination change to Individual Trunk Night Service mode so that calls coming into the trunk group are redirected to the group's designated Night Service extension (NSE). Incoming calls on trunk groups that are not assigned to Trunk Group Night Service are queued in the attendant queue. If the call remains unanswered during the Night Service Disconnect Timer interval, the incoming trunk disconnects.

In addition, a user can assign all the trunk groups to the night service mode at the same time. Then all the trunk groups are in the System Night Service mode. Any incoming calls made on the trunk groups are redirected to their designated NSE. To assign all the trunk groups to System Night Service, the user presses the System Night Service button on the principal attendant console or the Night Service button on a designated voice terminal. You can assign a Night Service button to only one voice terminal.

You can activate Night Service for specific trunk groups (Trunk Group Night Service) by pressing the individual Trunk Night Service buttons on the attendant console or on a voice terminal. You can assign Trunk Night Service buttons on more than one voice terminal.

## How to administer Trunk Group Night Service

### Required forms

| Form                       | Field   | Page                  |
|----------------------------|---|-----------------------|
| Station (multi-appearance) | ■ Button/Feature Button Assignments<br>— trunk-ns | <a href="#">6-14</a>  |
| Attendant Console          | ■ Feature Button Assignments<br>— trunk-ns        | <a href="#">5-35</a>  |
| Listed Directory Numbers   | ■ Night Destination                               | <a href="#">5-207</a> |

## Considerations

### Considerations for Hunt Group Night Service

- Both Hunt Group Night Service and Trunk Group Night Service can be active at the same time. An incoming trunk call is redirected to the trunk group's designated NSE. If this NSE is a hunt group or split that is in Hunt Group Night Service mode, the call is redirected to the Hunt Group NSE.

- Calls in progress (such as talking, on hold, or waiting in queue) on the hunt group or split are not affected when the hunt group or split is put in Hunt Group Night Service mode.
- When a hunt-group queue becomes empty, all idle members are placed in a busy condition.
- If Night Service is activated for a hunt group or split and a power failure occurs, the hunt group or split automatically returns to the Night Service mode.

### **Considerations for Night Console Service**

- The night console must be identical to and have the same features as the primary console. A daytime console can double as the night console.
- Night Console Service calls to the attendant group are still handled by an attendant, even though the primary and daytime attendant consoles are out of service.
- Only one night console is allowed in the system. The night console can be activated only when the primary and daytime consoles have been deactivated.
- If Night Console Service is active and a power failure occurs, the system automatically returns to Night Console Service mode when it is powered up.

### **Considerations for Night Station Service**

- When Night Station Service is active but you have not established Night Station extensions, a user can activate Trunk Answer from Any Station (TAAS).
- You can assign a Night-Serv button to either an attendant extension or a voice-terminal extension. An individual trunk group or hunt group can be put into night service by either an attendant extension or a voice-terminal extension with the necessary button. When a user presses this button to activate Night Station Service, all calls to that particular trunk group or hunt group are routed to the Night Service extension assigned to that group.
- If a trunk without disconnect supervision goes to Night Service, the system drops the trunk after a period of time to avoid locking up the trunk. The call is not routed to the DID-LDN night extension.

### **Considerations for TAAS**

- If Night Service is active and a power failure occurs, the system, when brought back up, automatically returns to Night Service mode.

## Considerations for Trunk Group Night Service

- All incoming calls on Night Service trunk groups go to the trunk group's NSE unless the trunk group member has its own Trunk Group Member Night Destination, in which case the calls are redirected to that destination instead of the trunk group's NSE.
- Calls already in progress on a trunk group (such as talking, on hold, or waiting in queue), are not affected when the individual Trunk Group Night Service or System Night Service is activated.
- Trunk Group Night Service and System Night Service work independently of one another.
  - When a user activates System Night Service, any trunks that are controlled by individual Trunk Group Night Service buttons remain in day service. Trunk groups that are not currently assigned to Trunk Group Night Service are assigned to System Night Service.
  - Trunks with individual Trunk Group Night Service can be removed from Night Service even though the rest of the system remains in Night Service.
  - When a user deactivates System Night Service, any trunks that have individual Trunk Group Night Service still active remain in night service.
  - Trunks with individual Trunk Group Night Service can be placed into Night Service even though the rest of the system remains in day service.
- If a trunk is added to a trunk group while that trunk group is in Trunk Group Night Service, the trunk is brought up in night service.
- Individual Trunk Group Night Service does not apply to DID trunk groups.
- If Night Service is activated for a trunk group, and a power failure occurs, the trunk group automatically returns to the Night Service mode.
- If for some reason, a voice terminal with a trunk-ns button remains out-of-service after a system reboot and later comes back in service, the trunk-ns lamp shows the trunk status within 10 seconds of coming back in service. For example, a voice terminal with a trunk-ns button may be unplugged when the system is rebooted. If the voice terminal is later plugged back in, the trunk status is shown on the trunk-ns button within 10 seconds.

## Interactions

---

### Interactions for Hunt Group Night Service

- ACD

When Hunt Group Night Service is active for a split and the night-service destination is a hunt group, the caller hears the first forced announcement for the original split. The system then redirects the call to the Night Service destination hunt group. When an agent in the Night Service hunt group becomes available, the call goes to that agent. If all agents in the hunt group are busy, the caller hears the following: forced or delayed first announcement, ringback, music-on-hold or silence, and a second announcement.

- Call Coverage

When Hunt Group Night Service is active, the NSE's normal coverage criteria and path apply. If the coverage path destination is AUDIX, AUDIX answers with the mail of the original hunt group. If the NSE is a hunt group or split of any type, the hunt group or split's call coverage criteria and coverage path apply. The coverage criteria and path can be different from that assigned to the voice terminals that are members of that hunt group or split.

If a coverage point is a hunt group or split in Night Service, the system considers the point to be unavailable and does not forward the call to the coverage point's NSE.

- Call Forwarding All Calls

If a hunt group or split is in Hunt Group Night Service mode and the hunt group or split's NSE has Call Forwarding — All Calls active, the system forwards night-service calls terminating to that NSE to its designated call-forward extension.

If the forwarded-to destination is a hunt group or split in Night Service mode, the system terminates the call at the forwarding extension.

### Interactions for Night Console Service

- Trunk Group Night Service

Activation of Night Console Service for the attendant consoles also puts trunk groups into night service, except those trunk groups for which you administered a Trunk Group Night Service button.

## Interactions for Night Station Service

- Call Coverage

Calls routed to the night extension via Night Station Service follow the coverage path of the night extension under all coverage criteria except Send All Calls.

If a night extension has a coverage path in which Cover All Calls is administered, all attendant-seeking calls redirect to coverage. Changes to the protocol for handling DID-LDN calls (that is, forwarding attendant-seeking calls on or off premise from the night extension) do not work.
- Call Forwarding All Calls

Calls redirected to the attendant via Call Forwarding All Calls do not route to the DID-LDN extension.
- Inward Restriction

Inward-restricted voice terminals can be administered for Night Station Service. Night Service features override Inward Restriction.
- Night Console Service

Do not provide Night Console Service with this feature.
- Remote Access

A Remote Access extension can be specified as the Night Station extension on an incoming, non-DID, trunk group.
- Tenant Partitioning

Each tenant may have a designated night-service station. The system directs calls to an attendant group in night service to the night-service station of the appropriate tenant (when a night attendant is not available). When someone places an attendant group into night service, all trunk groups and hunt groups that belong to tenants served by that attendant group go into night service. In this case, the system routes incoming calls to the night-service destination of the appropriate tenant.

Each tenant can have its own listed directory number (LDN) night destination, trunk answer on any station (TAAS) port, or night attendant.
- Timed Reminder

Timed Reminder calls returning to a console that has been placed in Night Service and has an assigned DID-LDN night extension are not redirected to the DID-LDN night extension. Rather, they are dropped.
- Trunk Answer from Any Station

TAAS and Night Station Service can both be assigned within the same system, but cannot be assigned to the same trunk group.



## Interactions for TAAS

- Call Coverage

If Night Station Service is active, calls that are redirected to the attendant via Call Coverage can be answered via TAAS.
- Call Forwarding All Calls

If Night Station Service is active, calls that are redirected to the attendant via Call Forwarding All Calls can be answered via TAAS.
- Inward Restriction

Inward-restricted voice terminals can activate TAAS for incoming trunk calls. Night Service features override Inward Restriction.
- Night Console Service

Do not provide a Night Console Service with TAAS.
- Night Station Service

TAAS and Night Station Service can both be assigned within the same system, but cannot be assigned to the same trunk group. Activating Night Station Service also activates Night Service — Trunk Group for any trunk group without an individual trunk-group Night Service button.
- Tenant Partitioning

Each tenant can have its own listed directory number (LDN) night destination, trunk answer on any station (TAAS) port, or night attendant.

## Interactions for Trunk Group Night Service

- Call Forwarding All Calls

If the individual Trunk Group Night Service mode and the trunk group's NSE have Call Forwarding All Calls activated, the night service calls terminating to that NSE are forwarded to the designated extension.
- Forced First Announcements

An interaction occurs with System Night Service and Forced First Announcement. For example, if hunt group A has a forced first announcement, assign the incoming CO trunk to terminate at hunt group A. Assign the incoming trunk's night-service destination to be another hunt group (hunt group B). Assign a Night Service button to the attendant.

With night service active on the attendant, the incoming CO call routes to the night-service destination hunt group B and does not play the Forced First Announcement of the incoming destination's hunt group A.

- **Listed Directory Number**

In System Night Service mode, all incoming LDN calls (except those using DID trunks) which have activated night service are redirected to their corresponding trunk group's NSE. Incoming LDN calls using DID trunks are directed to the Night Console Service, Night Station Service, or Trunk Answer From Any Station, respectively, whichever applies first. Non-LDN DID trunk calls terminate at the dialed extension.

## Off-Premises Station

---

Off-Premises Station allows a voice terminal located outside the building where the switch is located to be connected to the system. If central office (CO) trunk circuits are used, the voice terminal must be analog and must be FCC-registered or, outside the US, registered by the appropriate governmental agency. See *DEFINITY Enterprise Communications Server Release 6 System Description Pocket Reference* for cabling distance information for the various voice terminal types.

Digital protocol communications (DPC) sets can be used as off-premises terminals with the addition of the DEFINITY extender.

### How to administer Off-Premises Station

---

You administer off-premises stations in the same way as on-premises voice terminals, with the following exceptions. For voice terminals used as off-premises stations:

- `Off-Premises Station` field must be administered as yes.
- `R Balance Network` field must be completed.

#### Required forms

---

| Form             | Field                 | Page                 |
|------------------|-----------------------|----------------------|
| Station (Analog) | ■ Off Premise Station | <a href="#">6-28</a> |
|                  | ■ R Balance Network   |                      |

---

### Detailed description

---

Off-Premises Station requires cross-connecting capabilities and one port on a TN742, TN746B, or TN769 analog line or TN767 or TN464 DS1 tie trunk circuit pack for each interface to be provided. The TN746B, which is a 16-port, 48-volt circuit pack, can support an off-premises station. The TN746, which is a 16-port, 24-volt circuit pack cannot support an off-premises station.

#### NOTE:

The use of a message waiting indicator lamp on an off-premises station is not supported.

### Considerations

---

- Off-premises stations are useful when it is necessary to have a voice terminal located away from the main location.
- The maximum loop distance for off-premises stations is 20,000 feet (6093.34 meters) without repeaters.

## Interactions

---

The Distinctive Ringing feature might function improperly at an off-premises station due to the distance. However, the Distinctive Ringing feature can be disabled when `Off-Premises Station` is administered. If the Distinctive Ringing feature is not used with an off-premises station, the terminal receives 1-burst ringing for all calls.

## On-Hook Dialing

---

On-Hook Dialing allows 6400- and 8400-series voice terminal users to use keypad dialing without first going off-hook.

### How to administer On-Hook Dialing

---

#### Required forms

---

| Form                              | Field                                    | Page                  |
|-----------------------------------|--|-----------------------|
| Feature Related System Parameters | ■ On-hook Dialing on 6400/8400 Terminals | <a href="#">5-113</a> |
| Station                           | ■ Speakerphone                           |                       |

### Detailed description

---

On-Hook Dialing activates the built-in 1-way or 2-way speakerphone on 6400- and 8400-series voice terminals. Administer the speakerphone on the Station form.

### Considerations

---

When you first activate On-Hook Dialing, to make sure that the phone is in the S-channel signaling mode, you must go on-hook and then off-hook.

### Interactions

---

None.

## PC Console

---

PC Console is a telephone application that provides all of the functionality of the attendant console on any Windows-based PC. It is used as a call-handling station to answer incoming calls and place outgoing calls, and to manage and monitor some system operations.

PC Console supports the following languages: English, Parisian French, Latin American Spanish, and German. You can customize any of these languages, or input your own language.

### How to administer PC Console

---

#### Required forms

---

| Form               | Field | Page                 |
|--------------------|-------|----------------------|
| Console-Parameters | ■ All | <a href="#">5-86</a> |
| Attendant Console  | ■ All | <a href="#">5-35</a> |

### Interactions

---

None.

## PC/PBX Connection

---

PC/PBX Connection provides an integrated-voice and data-workstation interface from DEFINITY ECS to a 6300 or other compatible personal computer (PC). The connection provides access to a variety of host computers, allowing the PC to act as a terminal for the host.

### How to administer PC/PBX Connection

---

#### Required forms

---

| Form              | Field | Page                  |
|-------------------|-------|-----------------------|
| Personal Computer | ■ All | <a href="#">6-153</a> |

### Detailed description

---

PC/PBX Connection is a PC application that runs on the PC/PBX platform. This feature brings the voice terminal and PC together into an integrated voice and data workstation. The PC can be any IBM-compatible PC.

Lucent Technologies provides the hardware for this connection. The hardware consists of a PC expansion card and a 7-foot 4-pair modular cord. The software includes a variety of packages available from different vendors. Contact your Lucent Technologies representative for more information.

### Security measures

---

There are two areas where unauthorized use may develop with this feature. The first involves unauthorized users with a PC attempting to make calls from it. The software in the PC has a security setting. A user can place the PC in security mode when it is left unattended. Automatic security is an option on the administration program. With Automatic security enabled, executing the software brings up the program in security mode. This mode is password-protected on the PC. Change the password often, and secure records of it.

The second area involves remote access to the PC over its data extension. Deleted or copied files store in the PC with this feature. This can be password-protected. Change the password frequently and secure. Consult the *BCS Product Security Handbook*, for additional steps to secure your system and to find out about obtaining information regularly about security developments.

## Considerations

---

- PC users with PC/PBX Connection are linked for easy access to other PCs, modem pooling, and on- and off-site computers.

## Interactions

---

- Call Log

When a station is optioned for PC/PBX Connection on the station form, and if using a display set, the call display is slightly altered. Omit the appearance identifier (a=, b=, c=, d=). If enabling the Call Log feature in the PC/PBX Connection software, the display information is captured to disk. You can search the log. Search criteria begins at the left of the displayed information. By omitting the appearance designator, a user can enter a search string without contending with the appearance identifiers in the displayed information.

## Software requirements

---

Install one of the following PC/PBX software packages on the PC:

- **PC/PBX Connection Package 1**

Provides features such as keyboard dialing, personal phone directory, directory dialing, and message retrieval. Hardware requirements include PC, 7404D voice terminal equipped with a message cartridge.

- **PC/PBX Connection Package 3**

Provides Package 1 services plus additional features (call log, higher file transfer rates, and the ability to take notes on a call). Hardware requirements include PC equipped with a DCP card and a 7400D series voice terminal. Package 3 provides an integrated voice and data workstation that supports:

- Dialing calls from the PC
- Use of customized phone features from the PC keyboard
- Creating a personal phone directory in the PC, searching the directory, and dialing voice and data calls from the directory
- Reading phone messages on the PC screen and having the PC automatically dial calls to users that have left messages
- Logging all incoming and outgoing calls (voice and data) and the ability to automatically recall them
- Using an associated speakerphone to make hands-free calls
- Use of a security feature to keep directory and message information private



- Use of the PC as a terminal connected to a variety of host computers
- Transferring files between the PC and another PC or host computer
- Setting up script programs to have the system perform selected data functions automatically
- Using voice and data functions simultaneously. Perform PC application while running the PC/PBX Connection software application in the background

■ **PC/PBX Connection Package 5**

Package 5 allows the PC to emulate a 3278/3279 terminal. This is a software enhancement to Package 3 and works with Package 3 hardware and software.

## Personal Station Access

---

Personal Station Access (PSA) allows a user whose station is translated to his or her own preferences and permissions to associate those preferences and permissions with any other compatible terminal. Preferences and permissions include the definition of terminal buttons, abbreviated dial lists, and COS and COR permissions assigned to the user's station. PSA requires the user to enter a security code. PSA can be used on-site or off-site.

### How to administer PSA

---

#### Required forms

---

| Form                              | Field  | Page                  |
|-----------------------------------|--|-----------------------|
| Feature-Related System Parameters | ■ TTI State  | <a href="#">5-123</a> |
|                                   | ■ Record PSA/TTI Transactions in History Log (optional)            |                       |
| Class of Service                  | ■ Personal Station Access  | <a href="#">5-81</a>  |
| Station                           | ■ Security Code  | <a href="#">6-28</a>  |
| Feature Access Code (FAC)         | ■ Personal Station Access (PSA) Associate Code and Dissociate Code | <a href="#">5-113</a> |

### Detailed description

---

PSA makes it convenient for different users to use the same bank of phones at different times. For example, several telecommuting employees can use the same office on different days of the week. The employees use PSA to “associate” with the office voice terminal — that is, make the terminal “theirs” for the day. Calls that an employee originates from the station are recognized and displayed as the employee's calls, and the calls routed to the employee's extension route to the voice terminal “associated” with that extension.

Many types of DCP terminals exist, and these terminals have different types and numbers of buttons. If you attempt to associate DCP stations with DCP terminals that have incompatible buttons, button mapping is unpredictable. This is also true of hybrid terminals. If you want a user to be able to use the terminal buttons and to have consistent displays, associate stations with terminals of the same type.

When the employee no longer needs to use the office, he or she “dissociates” from the terminal.

A telecommuting employee can also use PSA when working at home. For example, the employee installs a DCP terminal and a DEFINITY Extender at home, calls into the system, and uses PSA to associate the remote voice terminal

with their extension. The system associates the home terminal — that is, recognizes the home terminal as having the employee’s preferences and permission. When someone calls the employee’s extension, the call rings at the employee’s home.

The dissociate function within PSA allows a user to restrict the features available to a voice terminal. When a terminal has been dissociated using PSA, it can be used only to call an attendant or to accept a TTI or PSA request.

 **NOTE:**

Once a station has been associated with a terminal, anyone using the terminal has the capabilities of the associated station. Be sure to execute a dissociate request if the terminal can be accessed by unauthorized users. This is particularly important if you use PSA and DCP extenders to permit remote DCP access.

**End-user procedures**

The user executes the following steps to make a station his or hers. If a user enters more than 15 digits before entering the second #, the system generates intercept tone.

**Table 4-83. Personal Station Access procedures**

| User Action                             | System Response   | Result  |
|---|---|---|
| 1. Enter the PSA associate FAC.         | <ul style="list-style-type: none"> <li>■ Dial tone</li> <li>■ Intercept tone</li> </ul> | <p>The request is successful.</p> <p>The request is not successful because it was not made at an analog, hybrid, or DCP terminal.</p> <p>The request is not successful because the terminal is associated with or assigned to a station that does not have PSA permission in its COS.</p> |
| 2. Enter user extension, followed by #. | <ul style="list-style-type: none"> <li>■ No response</li> </ul>                         | <p>If the user is working at a terminal with display capabilities, this pound sign is the last character the system displays until the PSA sequence is completed.</p>   |

*Continued on next page*

Table 4-83. Personal Station Access procedures — *Continued*

| User Action   | System Response   | Result  |
|---|---|---|
| <p>3. Enter the Station Security Code (SSC) defined for the user's extension, followed by the second #.</p> | <ul style="list-style-type: none"> <li>■ Confirmation tone</li> </ul> | <p>The command sequence is complete and error free; the system queues the request.</p> <p>Under the following conditions, the user receives intercept tone <i>immediately</i> following the confirmation tone. If the user receives intercept tone, the user needs to execute the PSA request again.</p> <ul style="list-style-type: none"> <li>— TTI is not enabled for voice.</li> <li>— Either the dialed extension or the originating extension has an add, change, or remove action in progress.</li> </ul>  |
|   | <ul style="list-style-type: none"> <li>■ Intercept tone</li> </ul>    | <p>The request is not successful because the user entered incompatible extension and SSC information — that is, the extension is invalid, the SSC is invalid for the extension, or both. This will be logged as an invalid attempt by the Security Violation Notification (SVN) feature.</p> <p>The request is not successful because the user has requested association with a station that does not have PSA permission in its COS.</p> <p>The request is not successful because the user is attempting to associate a station in one tenant partition to a station in another partition.</p> |
|   | <ul style="list-style-type: none"> <li>■ Reorder tone</li> </ul>      | <p>The request is not successful because the dialed extension is in use.</p> <p>The request is not successful because an agent is logged in at the dialed extension.</p> <p>The request is not successful because the system load is too heavy to allow the requested action to occur. The user can try again later.</p>  |

## How to interrupt the associate command sequence

If the user realizes that he or she has entered incorrect information following the FAC and wishes to interrupt the command sequence and begin again, the user can enter an asterisk (\*) at any point before the second pound sign. When the user enters an asterisk, the system provides dial tone, and the user can begin the command sequence at the point of entering the user's extension. (The user should not enter the FAC again). The interrupted command sequence will not be recorded as an invalid attempt by the SVN feature.

## How to use PSA dissociate

The user enters the PSA dissociate FAC to dissociate his or her station from a terminal. The possible system responses to this request are described below.

- Confirmation tone  
The request is successful. The system provides confirmation tone if the system successfully dissociated the terminal and also if the terminal was not previously associated. In either case, the terminal is in the state requested by the user.
- Intercept tone  
The station does not have PSA permission in its COS.

## Considerations

---

- A user request for a PSA associate will automatically dissociate another station from the terminal.
- Extensions that do not have a COS, such as EAS agents or hunt groups, cannot use PSA.
- PSA-invalid attempts generate referral calls and are recorded by Security Violation Notification software, if that feature is enabled.
- If a user interrupts the PSA dialing sequence by pressing the release button or by hanging up, the system does not log the action as an invalid attempt.

- PSA functions only on analog, hybrid, and DCP terminals. In addition, the terminal at which the PSA request is made must be compatible with the terminal to which it is to be associated. The following table provides a list of permissible associations.

| Type of terminal at which PSA request is made | Type of Station to be associated |        |        |     |
|---|----------------------------------|--------|--------|-----|
|   | BRI                              | Analog | Hybrid | DCP |
| BRI   | No                               | No     | No     | No  |
| Analog  | No                               | Yes    | No     | No  |
| Hybrid  | No                               | No     | Yes    | No  |
| DCP   | No                               | No     | No     | Yes |

- The system does not limit the number of stations that can use PSA. However, heavy use of the associate and dissociate functions may temporarily impact system performance.
- PSA allows a dissociate request from a bridged appearance. However, when a user executes a dissociate command from Terminal B, even if the user is on a bridged appearance of an extension belonging to Terminal A, the user dissociates the station belonging to Terminal B.
- Stations and ports on different switches cannot be PSA associated. This includes stations on different switches (or nodes) within DCS environments.
- PSA commands cannot be successfully executed during a save translations.
- When a reset 3 or greater (reset 4, reset 5, and so on) occurs on the system, all associations revert to their state as of the last save translations.

## Interactions

---

- Adjunct/Switch Application Interface  
An ASAI link cannot use this feature because ASAI uses a BRI port. Do not assign an ASAI link to a COS that allows PSA.
- Bridged Appearance  
When a user executes a PSA dissociate request for the principal station, its bridged appearances remain active if the stations on which they appear have not been dissociated. When a call is made to the principal extension, any of its bridged appearances that can be alerted are alerted. Otherwise, the call follows the principal extension's coverage path.  
PSA dissociate requests executed at a bridged appearance dissociates the station that the bridged appearance is on.

## 4 Basic Features

### *Personal Station Access*

Page 4-479

- Call Management

PSA dissociate automatically logs out an ACD agent.

- Coverage

PSA does not change coverage path operations. If a station is dissociated, its calls still go to coverage unless they are forwarded.

- Property Management System

A station that is assigned to a room, rather than to a person who needs to work in multiple locations should not use PSA. Such a station should not have PSA in its COS.

- Security Violation Notification

PSA security violations are tracked and reported by SVN, if it is active.

- Tenant Partitioning

If a terminal is already associated, a user attempting a PSA associate request at that terminal must specify a station in the same partition as the station already associated with the terminal.

However, anyone, in any partition, can execute a PSA dissociate request at the terminal (if the associated station has PSA in its COS) and then execute a PSA associate request for a station in any tenant partition.

## Personalized Ringing

---

Personalized Ringing allows users of some voice terminals to have one of 8 ringing patterns for incoming calls. Users working closely in the same area can each specify a different ringing pattern. This enables the users to distinguish their own ringing voice terminal from other voice terminals in the same area.

### How to administer Personalized Ringing

---

#### Required forms

---

| Form                           | Field                          | Page                  |
|--------------------------------|--------------------------------|-----------------------|
| Station                        | ■ Personalized Ringing Pattern |                       |
| — 7303S, 7305S                 |                                | <a href="#">6-73</a>  |
| — 7404D                        |                                | <a href="#">6-90</a>  |
| — 7406D, 7406D+, 7407D, 7407D+ |                                | <a href="#">6-111</a> |
| — 7434D                        |                                | <a href="#">6-121</a> |
| — 8403B, 8405B, 8405B+, 8410B  |                                | <a href="#">6-172</a> |
| — 8405D, 8405D+, 8410D, 8434   |                                | <a href="#">6-180</a> |
| — 8411B, 8411D                 |                                | <a href="#">6-189</a> |
| — CALLMASTER II and III        |                                | <a href="#">6-141</a> |

You can administer Personalized Ringing for each voice terminal. Either you or the end-user can administer Personalized Ringing for a 7404D, 7406D, 7406D+, 7407D, or 7407D+programmable voice terminal.

### Detailed description

---

The eight administrable ringing patterns are different combinations of three tones:

- 750 Hz, 750 Hz, 750 Hz (normal ringing)
- 1060 Hz, 1060 Hz, 1060 Hz
- 530 Hz, 530 Hz, 530 Hz
- 530 Hz, 1060 Hz, 1060 Hz
- 1060 Hz, 1060 Hz, 530 Hz
- 1060 Hz, 530 Hz, 530 Hz
- 1060 Hz, 530 Hz, 1060 Hz
- 530 Hz, 1060 Hz, 530 Hz



## **End-user procedures**

The 7404D user can select the desired ringing pattern via the voice-terminal's menu options. The 7406D or 7407D user can select the desired ringing pattern by pressing the Shift key and the Select Ring button. The 7103A programmable voice-terminal user can select one of four ringing patterns via a slide switch on the voice terminal.

## **Power failures**

The user-specified ringing pattern for a 7404D, 7406D, 7407D, or CALLMASTER digital voice terminal is lost when the power fails. The user-specified ringing pattern is retained for ISDN-BRI voice terminals when the power fails.

## **Interactions**

---

- **Distinctive Ringing**

With Distinctive Ringing, you can administer the relationship between the number of ring bursts and the call type. The Personal Ringing Pattern selected is the same ringing pattern used in the Distinctive Ringing cycles.

## Power Failure Transfer

---

Power Failure Transfer provides service to and from the local telephone company central office (CO) during a power failure or when service is impaired.

Power Failure Transfer is also call Emergency Transfer; the terms are synonymous.

### How to administer Power Failure Transfer

---

None required

### Detailed description

---

Power Failure Transfer allows specific types of voice terminals to access the local CO and to answer incoming calls during a power failure.

Each DEFINITY ECS cabinet supports Power Failure Transfer panels via the AUX connectors on the rear panel. The Power Failure feature activates when:

- A transfer panel or associated cabinet loses power
- Manually activating the Emergency Transfer switch on the associated cabinet maintenance circuit pack
- Under software control when it is determined that service for that cabinet is severely impaired

You cannot activate any other system features during a complete system power failure.

Power Failure Transfer panels are available in multiples of five terminals.

Voice Terminals must be 500-type (rotary dial) or 2500-type (touch-tone or DTMF). You must use rotary dialing if the CO accepts dial pulses only. When a DEFINITY ECS system is not in Power Failure Transfer mode, power-failure transfer terminals can be used as regular extensions. Each voice terminal can be connected to a separate CO.

### Interactions

---

- Night Service  
If a power failure occurs when the system is in night service, the system automatically returns to night service when power returns.

## Priority Calling

---

Priority Calling provides a special form of call alerting between internal voice-terminal users, including the attendant. The called party receives a distinctive ring when the calling party uses Priority Calling.

### How to administer Priority Calling

---

#### Required forms

| Form                              | Field   | Page                  |
|-----------------------------------|---|-----------------------|
| Feature Access Code (FAC)         | ■ Priority Calling Access Code                    | <a href="#">5-113</a> |
| Class of Service                  | ■ Priority Calling                                | <a href="#">5-81</a>  |
| Attendant Console                 | ■ Feature Button Assignments<br>— priority        | <a href="#">5-35</a>  |
| Station (multiappearance)         | ■ Button/Feature Button Assignments<br>— priority | <a href="#">6-14</a>  |
| Feature-Related System Parameters | ■ Distinctive Audible Alerting                    | <a href="#">5-123</a> |

### Detailed description

---

You administer the priority-calling ringing-pattern system wide. Default is a 3-burst alerting signal. You allow feature use for each voice-terminal user by administering the user's class of service.

The following types of calls are always priority-calling calls:

- Call coverage consult
- Automatic callback
- Ringback queuing
- Attendant intrusion
- Security violation notification

The system generates the call waiting ringback tone that a single-line voice-terminal user hears even if the user is active on a call. In contrast, the system *does not* generate the pattern for a multiappearance voice-terminal if there are no idle call appearances. In this case the caller hears busy tone. However, the system does generate the pattern if the terminal has an idle call appearance, including the one reserved for call origination.

A user activates priority calling by dialing a priority-calling access code or pressing a priority button, followed by the desired extension. A user can change a normal call to a priority call even after it begins ringing at the called extension. The user does this by pressing the priority button.

## Interactions

---

- **Abbreviated Dialing**

If a priority call is to be made to a number in an abbreviated dial list, an Abbreviated Dial button must be used. If a user attempts to use Abbreviated Dialing (either by button or FAC) after dialing the Priority Access Code, the system denies the call.
- **Bridged Call Appearance**

A Bridged Call Appearance receives ringing on a priority call if its Bridged Call Alerting field on the Station form is **y**.
- **Call Coverage**

Priority Calling calls do not redirect to coverage unless the caller activates Go to Cover. If the call redirects, it remains a priority call, and the covering user receives a distinctive (default is three-burst) ringing signal.
- **Call Forwarding All Calls**

Priority Calling calls (except callback calls) are forwarded, and the forwarded call remains a priority call.
- **Call Vectoring**

The system generates intercept tone when someone attempts to activate Priority Calling toward a Vector Directory Number (VDN).
- **Call Waiting Termination**

A Priority Calling call waits on an active single-line voice terminal even if Call Waiting Termination is not assigned to the voice terminal. The active, single-line voice-terminal user receiving the call hears a distinctive (default is three-burst) priority Call Waiting tone.
- **Consult**

A Consult call acts as a priority call and waits at a single-line voice terminal, even if the terminal does not have Call Waiting Indication assigned.
- **Dial Access to Attendant**

A Priority Calling call to an attendant alerts the attendant as a non-priority call. The attendant can originate Priority Calling calls.

- Distributed Communications System

On a DCS tandem call to a single-line voice terminal, the called party does not receive priority ringing if the caller activates Priority Calling by pressing the priority button *after making a call*.

- Last Number Dialed

If a priority call is to be made to the last number dialed, the Last Number Dialed button must be used. The Last Number Dialed feature access code is not valid after Priority Calling has been activated.

Single-line voice terminals (2500 series) can be administered so that distinctive signals are not provided. In this case, 1-burst ringing is provided for priority calls.

- Security Violation Notification

Security Violation Notification calls are priority calls.

## Privacy — Attendant Lockout

---

Privacy — Attendant Lockout prevents an attendant from reentering a multiple-party connection held on the console unless recalled by a voice-terminal user.

### How to administer Privacy — Attendant Lockout

---

#### Required forms

---

| Form               | Field               | Page                 |
|--------------------|---------------------|----------------------|
| Console-Parameters | ■ Attendant Lockout | <a href="#">5-86</a> |

### Considerations

---

- Privacy — Attendant Lockout provides privacy for parties on a multiple-party call held on the console. The held parties can hold a private conversation without interruption by the attendant.

### Interactions

---

- Attendant Recall  
Use Attendant Recall to recall the attendant to a call that is originally conferenced or held by the attendant.
- Individual Attendant Access  
Privacy — Attendant Lockout applies only to attendant-group calls. It does not affect individual attendant calls.
- Trunk-to-Trunk Transfer  
Privacy — Attendant Lockout does not function when a call using Trunk-to-Trunk Transfer is held on the console.

## Privacy — Manual Exclusion

---

Privacy — Manual Exclusion allows multiappearance voice-terminal users to keep other users with appearances of the same extension from bridging onto an existing call.

### How to administer Privacy — Manual Exclusion.

---

#### Required forms

---

| Form                      | Field   | Page                 |
|---------------------------|---|----------------------|
| Station (multiappearance) | ■ Button/Feature Button Assignments — exclusion | <a href="#">6-14</a> |

---

### Detailed description

---

To activate Privacy — Manual Exclusion for a call, press the Exclusion button.

If you press the Exclusion button while other users are bridged onto the call, the other users are dropped from the call.

Privacy — Manual Exclusion is automatically deactivated when the Exclusion button is pressed a second time or when the party who activated Privacy — Manual Exclusion is dropped from the call.

### Considerations

---

Privacy — Manual Exclusion prevents users who have an appearance of another terminal's extension from bridging onto that extension.

### Interactions

---

- Bridged Call Appearance  
When Privacy — Manual Exclusion is activated, all other users are prevented from bridging onto the active call.
- Call Coverage  
When the principal user bridges onto a call that has gone to coverage and been answered at the coverage point, the principal user is not dropped when Privacy — Manual Exclusion is activated.

#### 4 Basic Features

##### *Privacy — Manual Exclusion*

Page 4-488

- Call Pickup

The called party is not dropped in the following scenario when Privacy — Manual Exclusion is activated: a call is made to a Station A and is picked up, using Call Pickup, by Station B. Station A then bridges onto the call by going off-hook on its call appearance. Station B activates Privacy — Manual Exclusion.



## Public Network Call Priority

---

Public Network Call Priority provides Call Retention, Forced Disconnect, Intrusion, Mode-of-Release Control, and Rering to switches on public networks. Different countries frequently refer to these capabilities by different names. Not all features are available in every country.

### How to administer Public Network Call Priority

---

#### Required forms for China

---

| Form   | Field  | Page                  |
|--|--|-----------------------|
| Multifrequency-Signaling-Related System-Parameters | ■ Incoming Forward Signal Types for group I and group II | <a href="#">5-228</a> |
|  | ■ Incoming Backward signal Types for group A and group B |                       |
| Trunk Group  | ■ Country (set to 18)                                    | <a href="#">7-115</a> |
|  | ■ Outgoing Dial Type (set to mf)                         |                       |
|  | ■ Incoming Dial Type (set to mf)                         |                       |

#### Required forms for Russia

---

| Form               | Field                          | Page                  |
|--------------------|--------------------------------|-----------------------|
| Trunk Group (DID)  | ■ Country (set to 15)          | <a href="#">7-178</a> |
|                    | ■ Protocol Type (set to Intol) |                       |
| Trunk Group (DIOD) | ■ Country (set to 15)          | <a href="#">7-183</a> |
|                    | ■ Protocol Type (set to Intol) |                       |

#### Required forms for Spain

---

| Form        | Field                 | Page                  |
|-------------|-----------------------|-----------------------|
| Trunk Group | ■ Country (set to 11) | <a href="#">7-115</a> |

## Detailed description for China

### Forced Disconnect

Forced Disconnect allows a network operator to disconnect a called party from a local call and connect the called party to an incoming toll call. Parties on the local call hear a warning tone before disconnect. Forced Disconnect is allowed only for callers on local single-station calls. It is ignored by DEFINITY ECS on conference, transferred, and forwarded calls. It is also ignored for calls to group users and tandem calls.

### Mode-of-Release Control

Mode-of-Release Control inhibits release of a trunk circuit when a caller goes on-hook, based on call type and direction. Instead of releasing the trunk circuit, DEFINITY ECS keeps the circuit active and reconnects the call if the caller goes back off-hook. Call types for which this applies are toll, local, or service. Direction is incoming or outgoing. There are three types of control.

#### Calling-Party Control

When Calling-Party Control is active, the trunk is not released until the caller goes on-hook. Several situations may occur.

- If the caller goes on-hook, the trunk is released immediately. The called party receives busy tone.
- If the called party goes on-hook, the trunk is not released until the caller goes on-hook or the re-answer timer for outgoing calls expires. The called party can re-answer the call and talk to the calling party. See [“Rering” on page 4-491](#).
- If the re-answer timer is activated and expired, the trunk is released on outgoing calls with Calling-Party Control.

#### Called-Party Control

When Called-Party Control is active, the trunk is not released until the called party goes on-hook. Several situations may occur.

- If the called party goes on-hook, the trunk is released immediately. The caller receives busy tone.
- If the caller goes on-hook, the trunk is not released until the called party goes on-hook. The caller can go off-hook again to reconnect. There is no timer involved with Called-Party Control.

#### First-Party Control

When First-Party Control is active, the trunk is released immediately regardless of whether the caller or called party goes on-hook first. The party that is still connected receives busy tone. The default or normal Mode-of-Release Control for DEFINITY ECS is First-Party Control.

## Rering

Rering occurs for incoming calls to DEFINITY ECS with Calling-Party Control. Basically, when the called party goes on-hook, the trunk is not released and Rering allows the CO operator to rering the called party and reconnect the call.

### Detailed description for Russia

#### Intrusion

Intrusion allows a network operator to break into a local call and announce an incoming toll call. Intrusion is allowed on local, single- and multiple-line station calls. It is ignored by DEFINITY ECS on conference calls, calls on hold, and other toll calls.

## Rering

Rering occurs when a call is interrupted by an operator-assisted incoming call and kept on hold so that it can be reconnected to a voice terminal. When the called party goes on-hook, the network toll operator can rering the called party and reconnect the call.

### Detailed description for Spain

#### Call Retention

When a caller makes an emergency call and then hangs up, the call is not disconnected, but put on hold. When the caller goes back off-hook, the caller's voice terminal reconnects to the emergency call. This feature works on both analog and digital voice terminals.

## Rering

Rering occurs when a call is interrupted by an operator-assisted incoming call and kept on hold so that it can be reconnected to a voice terminal. When the called party goes on-hook, the network toll operator can rering the called party and reconnect the call.

### Interactions

#### China Forced Disconnect Interactions

- Conference

If the network toll call terminates at a voice terminal involved in a conference, the Forced Disconnect signal is not sent by the network.

**4 Basic Features**

*Public Network Call Priority*

*Page 4-492*

- **Call Forwarding**  
For calls forwarded on-premises, on-net, or off-net, the Forced Disconnect signal is not forwarded.
- **Group Users**  
If a network toll call terminates to a group user, the Forced Disconnect signal is not sent by the network.
- **Non-Station Users**  
If a network toll call terminates to a non-station user, the Forced Disconnect signal is not sent by the network.
- **Tandem Trunks**  
DEFINITY ECS does not tandem a Forced Disconnect signal.
- **Transfer**  
If a network toll call is transferred, the Forced Disconnect signal is not sent by the network.

**China Mode-of-Release Control Interactions**

- **Conference**  
A call involved in a conference is changed to First-Party Control as the mode-of-release control.
- **Forward**  
A forwarded call on-premises, on-net, or off-net is changed to First-Party Control as the mode-of-release control.
- **Group Users (Hunt, Trunk, TEG, AUDIX, VDN)**  
Calls terminating to group users are changed to First-Party Control as the mode-of-release control.
- **Non-Station Users (Personal Attendant, Data-module, Announcement, Voice Synthesis)**  
Calls terminating to non-station users are changed to First-Party Control as the mode-of-release control.
- **Tandem Trunks**  
DEFINITY ECS terminates tandem calls, but the mode-of-release control is changed to First-Party Control.
- **Transfer**  
A transferred call is changed to First-Party Control as the mode-of-release control.

## China Rering Interactions

- Conference

A call involved in a conference is changed to First-Party Control as its mode-of-release control. First-Party Control calls do not rering.
- Call Forwarding

For calls forwarded on-premises, on-net, or off-net, Rering signals are not forwarded.
- Group Users (Hunt, Trunk, TEG, AUDIX, and VDN, etc.)

Rering signals sent to group users are ignored by DEFINITY ECS.
- Non-Station Users (Personal Attendant, Data-module, Announcement, Voice Synthesis)

Rering signals sent to non-station users are ignored by DEFINITY ECS.
- Tandem Trunks

DEFINITY ECS does not tandem rering signals.
- Transfer

A transferred call is changed to First-Party Control as its mode-of-release control. First-Party Control calls do not rering.

## Russia Intrusion and Rering Interactions

- Announcements

DEFINITY ECS ignores Intrusion and rering when directed toward an announcement port.
- Abbreviated Ringing and Delayed Ringing

Abbreviated Ringing and Delayed Ringing characteristics assigned using this feature do not apply to Rering. Rering has its own priority ringing.
- Administered Connections

Intrusion and rering do not apply to Administered Connections.
- Attendant Console

Intrusion and rering do not apply to attendant consoles. They do not apply to any call involving an attendant console.
- Attendant Serial Call

DEFINITY ECS ignores Intrusion and rering when directed toward an attendant serial call.
- Automatic Callback

Rering takes precedence over automatic callback on busy or no-answer calls.

## 4 Basic Features

### Public Network Call Priority

Page 4-494

- **Busy Verification and Attendant Intrusion**

While Intrusion or rering occurs, Busy Verification and Attendant Intrusion are denied. While Busy Verification or Attendant Intrusion occurs, Intrusion and rering are denied.
- **Call Coverage**

Rering overrides Call Coverage. However, if a station is busy and a coverage destination is free, an incoming toll call rings at the coverage destination instead of intruding on the busy call.
- **Call Forwarding**

Intrusion can be used with Call Forwarding. If a station is busy, an incoming toll call is forwarded instead of intruding on the busy call. rering, however, overrides all administered redirection.
- **Call Waiting**

If Call Waiting is active, calls are not intruded upon. Call Waiting takes precedence.
- **Conference**

Intrusion is not permitted to a call involved in a conference.
- **Data Calls**

Intrusion is not permitted to voice terminals that have data privacy, data restriction, or data protection active.
- **Distinctive Ringing**

Ringling characteristics assigned using this feature do not apply to rering. Rering has its own priority ringling.
- **Do Not Disturb**

Intrusion is not permitted while Do Not Disturb is active.
- **Emergency Access to the Attendant**

Intrusion is not permitted to an emergency call.
- **Hunt Group and Automatic Call Distribution**

If a hunt group queue is not busy, incoming toll calls are placed in the queue. Busy calls are not intruded upon.
- **Intercom (Automatic and Dial)**

Intrusion is permitted on Intercom (automatic and dial) calls.
- **Malicious Call Trace**

Intrusion is not permitted to a station that has Malicious Call Trace active.
- **Personal Station Access**

Intrusion is not permitted while Personal Station Access is used.

**4 Basic Features**

*Public Network Call Priority*

*Page 4-495*

- Pull Transfer  
Intrusion is not permitted while Pull Transfer is used.
- Restriction  
Intrusion is permitted regardless of COR.
- Ringback Queuing  
Intrusion is permitted with Ringback Queuing.
- Station Hunting  
Intrusion is permitted while Station Hunting is used.
- Tandem Trunks  
Intrusion is not permitted over trunk groups used as tandem trunks.

## Pull Transfer

---

Pull Transfer allows either the transferring or transferred-to party to press the TRANSFER button to complete the transfer operation.

### How to administer Pull Transfer

---

#### Required forms for Pull Transfer

---

| Form                              | Field  | Page                  |
|-----------------------------------|--|-----------------------|
| Feature-Related System Parameters | ■ Pull Transfer                                      | <a href="#">5-123</a> |
| Station                           | ■ All (including a Flash or Transfer feature button) | <a href="#">6-28</a>  |

---

### Considerations

---

When attendants control calls, called parties cannot use Pull Transfer. Attendants who are called parties cannot use Pull Transfer. When attendants have parties on hold they are transferred with the standard transfer process.

To use Pull Transfer, calling parties and called parties must be on the same switch, or called parties must be reached via Italian TGU/TGE tie trunks.

Called parties using analog telephones flash the switchhook or press the flash key or recall button to transfer calls. Called parties using digital phones press the transfer key to complete transfers.

### Interactions

---

- Analog Station Recall Operation and Feature Activation

When called parties initiate either analog-station recall or feature activation, callers are not put on hold for transfer, they are transferred via Pull Transfer.

- AUDIX

AUDIX does not work properly if Pull transfer is enabled.

- BRI stations

Callers using BRI Stations reach desired parties through an intermediate step by calling a party who calls a final destination. Intermediate parties activate pull transfer to complete transfers. Final called parties go off hook as if a new transfers was originated.

- Call Detail Recording

The switch checks to ensure that calls are correctly recorded with CDR when Pull Transfer is completed.



- Digital Station Transfer Operation

When called parties initiate transfer operations, callers are not put on hold for transfer; they are transferred via Pull Transfer.

- Non-BRI stations:

Callers using Non-BRI stations reach desired parties through an intermediate step by calling a party who calls a final destination. Each called party activates pull transfer.

## Recall Signaling

---

Recall Signaling allows the user of an analog station to place a call on hold, use the voice terminal for other call purposes, and then return to the original call.

### How to administer Recall Signaling

---

#### Required forms

---

| Form                              | Field                | Page                  |
|-----------------------------------|----------------------|-----------------------|
| Feature-Related System Parameters | ■ Flashhook Interval | <a href="#">5-123</a> |
|                                   | ■ Upper Bound        |                       |
|                                   | ■ Lower Bound        |                       |
| Station (Analog)                  | ■ Switchhook Flash   | <a href="#">6-14</a>  |

### Detailed description

---

To activate Recall Signaling:

- Press the flashhook
- Press the ground key on a rotary station
- Press the ground key or the Recall Button on a DTMF station

Recall Signaling allows the user of an analog station to place a call on hold and consult with another party or activate a feature. The user can then:

- Conference the third party with the original party by another recall signal
- Return to the original party by pressing the Recall button twice or by flashing the switchhook twice

Use Hold and Conference buttons on digital stations to perform these functions.

### Considerations

---

- You can disable Recall signaling for particular analog stations.
- You can administer how long the system recognizes the press of the flashhook as Recall Signaling or you may choose not to administer Recall Signaling at all.
- Using flashhook for Recall Signaling at times places a call on hold when the analog station user wanted to drop the previous call before dialing another party.

## **Interactions**

---

None.

## Recorded Announcement

---

The Recorded Announcement feature provides an announcement to callers under a variety of circumstances. For example, announcements let callers know that their call cannot be completed as dialed, that their call is in queue, or that all the lines are busy.

### How to administer Recorded Announcement

---

#### Required forms

| Form   | Field   | Page                  |
|--|---|-----------------------|
| Announcements/Audio Sources<br>(incl. Integrated Announcement<br>Translations) | ■ All   | <a href="#">5-26</a>  |
| Feature Access Code (FAC)  | ■ Announcement Access Code                              | <a href="#">5-113</a> |
| Station  | ■ COS   | <a href="#">6-4</a>   |
| Data Modules<br>(for Save/Restore/Copy)  | ■ All   | <a href="#">6-226</a> |
| — Netcon Data Module   |   | <a href="#">6-245</a> |
| — System Port Data Module (SAP)  |   | <a href="#">6-248</a> |
| — Announcement Data module   |   | <a href="#">6-233</a> |
| Circuit Packs <sup>1</sup>   | ■ All   | <a href="#">5-69</a>  |
| Feature-Related System Parameters <sup>2</sup>                                 | ■ DID/Tie/ISDN Intercept Treatment                      | <a href="#">5-123</a> |
|  | ■ Controlled Outward Restriction<br>Intercept Treatment |                       |
|  | ■ Controlled Termination<br>Restriction (DoNot Disturb) |                       |
|  | ■ Controlled Station-to-Station<br>Restriction          |                       |
| Hospitality <sup>2</sup>   | ■ Announcement Type                                     | <a href="#">10-30</a> |
|  | ■ Length of Time to Remain<br>Connected to Announcement |                       |
| Trunk Groups (All) <sup>2</sup>  | ■ Incoming Destination                                  | <a href="#">7-115</a> |

*Continued on next page*

### Required forms — *Continued*

| Form                       | Field                                   | Page                  |
|----------------------------|---|-----------------------|
| Coverage Path <sup>2</sup> | ■ Coverage Points                       | <a href="#">5-94</a>  |
| Hunt Group <sup>2</sup>    | ■ First Announcement Extension          | <a href="#">5-158</a> |
|                            | ■ Second Announcement Extension         |                       |
| Call Vector <sup>2</sup>   | ■ All fields that require announcements | <a href="#">9-207</a> |

1. You only need to complete the Circuit Pack form if you administer the Board Location on the Announcements/Audio Sources form or Data Module form and do not have the circuit pack plugged in.
2. You only need to complete this form if you plan to use Recorded Announcements with the form's associated feature. (For example, if you want to use announcements with the Hospitality features, you need to complete the Hospitality form.)

### Detailed description

The system supports several recorded announcement types.

#### Analog line

Requires an external announcement machine connected by way of an analog line port.

- Analog — Provides an analog voice-terminal interface via an analog line port for use with an announcement/audio sources devices that emulate analog voice terminals. DEFINITY ECS starts playback by applying ringing; the device indicates playback has stopped by going on-hook (opening the loop). DEFINITY ECS does not indicate to the device to stop playback. Use the analog type for announcements that play for a specific period and then go on-hook at the end. When the device goes on-hook to indicate that the playback ended, the caller listening to the announcement hears a click. (See ds1, aux-trk or integrated types for alternative types).
- Analog-m — Like the analog type, analog-m provides an analog line interface. However, ringing is not applied to start playback. Use this type for continuous playing music or audio sources. The device stays in an off-hook state when active and goes on-hook when the device is not playing, is turned off, or is disconnected.

## 4 Basic Features

### *Recorded Announcement*

Page 4-502

- Analog-fd — Like the analog type, analog-fd provides an analog line interface and ringing starts the playback. However, a forward disconnect signal (open loop for about one-half second) is sent to the device to stop playback when there are no callers left to hear it. This type would be used for a barge-in repeating announcement.

## DS1

The DS1 types provide analog-like interfaces via DS1 line ports — called Line Side DS1 or Line Side T1. Each of these types indicate to the announcement, music, or audio-source device to start playback via the Line Side T1 equivalent of ringing. The DS1 types also expect off-hook from the device to indicate that the playback is active and on-hook to indicate that the playback is not active.

The ds1-fd and ds1-sa types provide a forward disconnect via transitions of the “A” signaling bit to the device which indicates when playback should be stopped. Callers listening to announcements do not hear clicks when the device disconnects (goes on-hook).

- ds1-fd — Provides an EIA/TIA foreign-exchange (FX) type DS1 interface. The forward disconnect signal is a toggle of the “A” bit from 0 to 1 and then back to 0 after 600 msec. This type is used for CONVERSANT Line Side T1 ports when used as an analog-like announcement device and is the recommended method for interfacing.
- ds1-sa — Provides an EIA/TIA special-access type DS1 interface. The forward disconnect signal is a toggle of the “A” bit from 1 to 0 and then back to 1 after 600 msec.
- ds1-ops — Provides an EIA/TIA off-premises-station type DS1 interface used where the device does not support forward disconnect.

## Auxiliary trunk

Requires an external announcement machine connected via a 4-wire auxiliary trunk interface, such as a 15A announcement system. DEFINITY ECS indicates to the device to start or stop the playback on the S lead; the device indicates that the playback is active on the S1 lead.

## Integrated

Is stored internally on the switch on an Integrated Announcement circuit pack (TN750). Each circuit pack has 16 ports available for playing announcements. This is the recommended source for VDN of Origin Announcements as well as other general announcement needs.

## When to use the feature

This is a list of some useful applications for Recorded Announcements.

- DID calls cannot be completed as dialed.
- Incoming private-network-access calls cannot be completed as dialed.
- Calls enter a split or skill (first announcement).
- DDC, UCD, or direct-agent calls have been in queue for an assigned interval.
- ACD and Call Vectoring calls have been in queue for an assigned interval.
- A call's destination is a recorded-announcement extension.
- A call routes to a vector that contains an announcement step.
- An announcement extension is specified as a coverage point.
- An announcement is the incoming destination of a trunk group.
- VDN of origin announcement
- Security violation notification
- The Hospitality Automatic Wakeup feature is in use.

## About barge-in

Normally, the system connects multiple callers to the beginning of an announcement, regardless of announcement type. However, you can also administer auxiliary trunk announcements, DS1 announcements, and integrated announcements to allow callers to begin listening to an announcement after the system has begun playing its message. This capability is called "barge-in."

### What happens when you use barge-in

When you administer "barge-in", only one port plays the announcement at any one time. When the system routes a call to that announcement, the call immediately connects to the port and the caller hears the announcement as it is playing. Most administrators administer "barge-in" announcements to repeat continually while callers are connected to the port. In this way, the caller listens until the system plays the entire announcement.

### What happens when you do not use barge-in

If an announcement port is available when a call arrives, the system connects the call to the announcement.

If an announcement port is not available and the announcement is administered with "no" as the queue option, the caller hears busy or other feedback depending upon how the announcement was accessed.

If an announcement port is not available and the announcement is administered with "yes" as the queue option, the call enters the announcement queue. When a

port becomes available, the switch connects the calls waiting in the queue to the beginning of the announcement. The system first connects the call that has been waiting in queue the longest and then connects as many calls as it can.

## Integrated announcements and announcements recorded on external devices

Recorded Announcement allows you to administer either integrated announcements or announcements recorded on external devices. The external devices connect to the switch via analog-line circuit packs or auxiliary trunk interfaces, such as a TN2183 or a TN763.

The system stores an integrated announcement on a TN750 integrated-announcement circuit pack. The system can store multiple announcements on each circuit pack up to the system capacity. See *DEFINITY Enterprise Communications Server Release 5 System Description Pocket Reference* for capacity information.

Each Integrated Announcement circuit pack has 16 ports, and can play up to 16 simultaneous announcements. The system can connect multiple users to each of these announcements.

Any announcement stored on a circuit pack can play through any port on the circuit pack. Any announcement (not administered for "barge-in") can play simultaneously through multiple ports. All 16 ports could play the same announcement at the same time.

You must set the *Q* field to *y* (on the Announcements/Audio Sources form) for each extension that you want to queue for integrated announcements. Calls to hear integrated announcements at extensions that have queue assigned only queue when all 16 ports (on the circuit pack that contains the announcement) are busy. The same queuing pool is used over all boards. The system controls the announcement queue length for integrated announcements, but you must set the queue length for analog or aux-trunk announcements.

## Single integrated announcement boards

When your switch has only one integrated announcement circuit pack, the circuit pack can be either a TN750, a TN750B, or a TN750C.

### You need to back up a TN750 or TN750B circuit pack

You need to back up a TN750 or TN750B in the following situations:

- Before someone removes a TN750 or TN750B from the switch
- Before someone shuts down power to the switch

In both situations, the system loses any announcements stored on the circuit pack. Therefore, you need to backup announcements stored on the TN750 or TN750B circuit packs to the Mass Storage System (MSS). When someone inserts



or resets a circuit pack, or when someone powers up the system, the system checks the circuit pack for announcements. If the system determines that there are no announcements on the circuit pack, it automatically restores the announcements from the MSS.

 **CAUTION:**

*The announcements from MSS that are automatically restored are the last announcement saved to MSS. If multiple circuit packs are used, MSS might not contain the announcement for the B or A circuit pack.*

### You do not need to back up a TN750C circuit pack

The TN750C circuit pack has on-board FLASH memory backup, which substantially reduces the time required for power-up restore and eliminates the need for a manual save of the circuit pack contents.

The system retains announcements on the TN750C circuit packs, even when someone removes the circuit pack or when the system loses power. Therefore, the TN750C does not require the save and restore procedure. However, you can still use the save and restore procedure to copy the contents of a TN750C to another circuit pack.

### Multiple integrated announcement circuit packs

Multiple Integrated Announcement circuit packs can be installed in G3si and G3r switches. However, only one of these circuits can be a TN750 or TN750B. Any additional circuit packs must be TN750C circuit packs.

 **CAUTION:**

*Do not copy announcements from a TN750C to a TN750 or TN750B. This action may corrupt the announcement data.*

### Compression rates

The system stores integrated announcements on a TN750A at a compression rate of 32 Kbps. The system can store integrated announcements at one of three compression rates on the TN750B and TN750C circuit packs. You administer the compression rate separately for each announcement extension. In this way, the system can store announcements with different compression rates on the same circuit pack. During playback, the switch sets the port to the correct compression rate for the announcement that it is playing.

- A 64-Kbps compression rate allows for 128 seconds of recorded announcement per circuit pack.
- A 32-Kbps compression rate allows for 256 seconds of recorded announcement per circuit pack. This is the default compression rate.

## 4 Basic Features

### *Recorded Announcement*

Page 4-506

- A 16-Kbps compression rate allows for 512 seconds of recorded announcement per circuit pack. The 16-Kbps rate does not provide a high-quality recording. It is not recommended for customer announcements, but is adequate for VDN of Origin announcements.

## End-user procedures

End users record, play back, or delete integrated announcements by initiating an announcement session. However, these end users must have console permissions assigned to their Class of Service (COS) for the internal station or Remote Access barrier code in order to initiate an announcement session.

Announcement sessions always use port 0 on the integrated announcement circuit pack. To begin an announcement session, the user must dial the administered feature access code (FAC) followed by the announcement extension. If an announcement session is already in progress, or if a save or restore command is in progress, the user hears reorder tone (fast busy) and the system drops the call.

If port 0 is in use, the user hears reorder tone followed by silence. This indicates that the port will be reserved for an announcement session. The user should redial the FAC and extension every 45 seconds to gain access to the port.

Once an end user accesses an announcement session, the user can dial "1" to record an announcement, "2" to play an announcement, or "3" to delete an announcement. If the circuit pack memory is more than 90% full, the system gives stutter dial tone when the user gains access to an announcement session. Even if the user hears stutter tone, the user should begin speaking to record the announcement.

### **Begin the recording**

If the system user dials a "1", the switch attempts to start a recording session. If an announcement already exists and is protected (designated as protect=y), the user hears intercept tone. If the announcement is currently being played to callers, the user hears reorder tone. If the system is starting the recording session, the user hears record tone and can begin recording.

### **End the recording**

When the recording is complete, dial "#" from a hybrid or digital telephone or hang up from an analog telephone. If you are using an analog telephone, ending with a "#" puts a tone in the message. If you are using an analog telephone that is not connected via lineside T1 (DS1 type), the system records a click when you hang up. After hanging up, you can record another announcement for this extension or rerecord the same announcement before 15 seconds but you must wait 15 seconds to record a different announcement. If the circuit pack memory becomes full during recording, you will hear a reorder tone and the system drops you. The announcement is not retained.

## 4 Basic Features

### *Recorded Announcement*

Page 4-507

After you have completed a recording and hung up, do not immediately dial the extension. The announcement just recorded remains busy for approximately 15 seconds. The announcement just recorded can be played back by dialing the announcement feature access code, then the announcement extension, then "2" before the 15 second timer expires.

### **Play back the recording**

Upon completion of the recording session (drop), the system sets a 15-second timer. During this interval, the system restricts the user to one of two tasks: to listen to the announcement just recorded or to record another announcement.

If the user wants to listen to the announcement before it is available to others, the user dials the FAC, the extension, and "2." The system plays the announcement and then generates dial tone. The user can then perform another operation, such as record a message.

### **Delete the recording**

If the user dials "3", the system deletes the announcement and the user hears confirmation tone. If the announcement is protected or is currently being played, the system does not delete the announcement and the user hears reorder tone.

## **Interactions**

---

- **Automatic Call Distribution (ACD)**

Recorded announcements are used extensively for ACD, Call Vectoring, Call Prompting, Expert Agent Selection, VDN of Origin Announcement, Direct Department Calling, and UCD features. See the individual features for interaction details.

- **Automatic Wakeup**

Recorded Announcement allows Automatic Wakeup to use the built-in TN750B or later-suffix announcement circuit pack, in place of the Audichron adjunct.

If you use an integrated, multiple-integrated, or external type of announcement for Automatic Wakeup, you can also administer the announcement to repeat and to allow "barge-in" as a queue type. The benefit of repeating announcements and "barge-in" queues is that you do not need a separate port for each wakeup announcement. When guests go off-hook to receive an announcement at a particular time, they use only one port and the message repeats on the port until the last guest goes off-hook and the message ends.

## Recorded Telephone Dictation Access

Recorded Telephone Dictation Access permits voice-terminal users, including Remote Access and incoming tie-trunk users, to access dictation equipment.

Users start by dialing an access code or extension. Start/stop is controlled by voice or dialing. Initial activation and playback are controlled by dial codes.

### How to administer Recorded Telephone Dictation Access

#### Required forms

| <u>Form</u>         | <u>Field</u> | <u>Page</u>           |
|---------------------|--------------|-----------------------|
| CPE trunk group     | ■ All        | <a href="#">7-174</a> |
| 2500 Voice Terminal | ■ All        | <a href="#">6-47</a>  |

### Interactions

Recorded Telephone Dictation Access cannot be used with the following features:

- Automatic Route Selection
- Conference — Attendant
- Conference — Terminal

## Remote Access

---

Remote Access permits authorized callers from remote locations to access the system via the public network and then use its features and services.

Read the security information on [4-510](#) before administering this feature.

### SECURITY ALERT:

*Lucent Technologies has designed the Remote Access feature incorporated in this product that, when properly administered by the customer, enables the customer to minimize the ability of unauthorized persons to gain access to the network. It is the customer's responsibility to take the appropriate steps to properly implement the features, evaluate and administer the various restriction levels, protect access codes, and distribute them only to individuals who have been advised of the sensitive nature of the access information. Each authorized user should be instructed on the proper use and handling of access codes.*

*In rare instances, unauthorized individuals make connections to the telecommunications network through use of remote-access features. In such an event, applicable tariffs require that the customer pay all network charges for traffic. Lucent Technologies cannot be responsible for such charges, and does not make any allowance or give any credit for charges that result from unauthorized access.*

## How to administer Remote Access

---

### Required forms

| Form                             | Field                  | Page                  |                       |
|----------------------------------|------------------------|-----------------------|-----------------------|
| Remote Access                    | ■ All                  | <a href="#">5-258</a> |                       |
|                                  | or                     |                       |                       |
| Trunk Groups                     | ■ Permanently Disable? |                       |                       |
|                                  | ■ Incoming Destination | <a href="#">7-115</a> |                       |
|                                  | — CO                   | ■ Night Service       | <a href="#">7-168</a> |
|                                  | — FX                   |                       | <a href="#">7-193</a> |
|                                  | — ISDN-BRI             |                       | <a href="#">7-198</a> |
|                                  | — ISDN-PRI             |                       | <a href="#">7-219</a> |
|                                  | — WATS                 |                       | <a href="#">7-268</a> |
|                                  | — DID                  |                       | <a href="#">7-178</a> |
| Authorization Code — COR Mapping | ■ All                  | <a href="#">5-54</a>  |                       |

## Detailed description

---

Remote Access provides a caller with access to the system and its features from the public network. This allows an employee to make business calls from home or use Recorded Telephone Dictation Access to dictate a letter. Authorized users can also access system features from any on-site extension.

You can administer up to 10 barrier codes, each with a different COR and COS. Barrier codes can be from 4 to 7 digits, *but all codes must be the same length*. Barrier codes provide your system security and define calling privileges through the administered COR. You can also require that users enter an authorization code to use this feature. Both barrier codes and authorization codes are described under Security on [4-510](#).

Remote Access users can dial into the system using DID, CO, FX, or 800 Service trunks. When a call comes in on a trunk group dedicated to Remote Access, the system routes the call to the Remote Access extension that you have assigned. If DID is provided and the Remote Access extension is within the range of numbers that can be accessed by DID, Remote Access is accessed through DID.

Upon access to the feature, the user hears system dial tone. If you have administered your system to require a barrier code or authorization code, the system requires the user to enter it now. If the user enters the required codes, the system generates dial tone. The user can now place local or long-distance calls as allowed.

The destination of incoming non-DID trunk calls can be an attendant or an extension. The destination is specified on each individual trunk group. When the trunk group is dedicated to Remote Access, the Remote Access extension is specified. In this case, the user does all dialing. If an attendant is needed on a call, the user dials the public network telephone number assigned, the barrier code, and the attendant access code.

You can administer your system to provide attendant-assisted calling during the day but Remote Access after normal business hours. You do this by setting the trunk group `Incoming Destination` field to **attd** (the attendant), and specifying the Remote Access extension as the Night Service extension.

## Security

---

The system provides the ability to check the status of the remote access feature and barrier codes. The **status remote-access** command displays information that can help in determining why and when use of Remote Access or a particular barrier code was denied. The display indicates if Remote Access is:

- Not administered
- Enabled

- Disabled
- Disabled following detection of a security violation

It also gives the date and time that Remote Access was last modified.

For each barrier code, the command displays:

- Date the code was administered, reactivated, or modified
- Expiration date
- Number of calls that can be placed with the code
- Number of calls that have been placed using the code
- Whether the code is active or expired
- Date and reason a code expired

For a detailed description of the status remote-access command and display, see the *BCS Products Security Handbook*.

## Barrier Codes

Remote Access has inherent risks; it can lead to large-scale unauthorized long-distance use. To increase your system's security, use a 7-digit barrier code with Remote Access Barrier Code Aging. You can administer the Remote Access Barrier Code Aging feature to:

- Limit the length of time an access code remains valid
- Limit the number of times an access code can be used
- Both of the above

A barrier code automatically expires if an expiration date or number of accesses has exceeded the limits you set. If both a time interval and access limits are administered for a barrier code, the barrier code expires when one of the conditions is satisfied.

You must administer expiration dates and access limits for each of the possible 10 barrier codes. If your system has more than 10 Remote Access users, they must share codes.

When you no longer need a barrier code, remove it from the system. Barrier codes should be safeguarded both by you and their users.

If barrier codes are administered, a special answer-back tone causes a calling modem to leave dial mode. A modem's dialer is sometimes used to gain access (this tone also cancels echo suppressors in the network, preventing DTMF tones from breaking dial tone from a switch). Barrier codes can be used alone or with authorization codes.

Use the status remote-access command to view the status of a Remote Access barrier code.

 **NOTE:**

Barrier codes are *not* tracked by Call Detail Recording (CDR). Barrier codes are incoming access codes, whereas, authorization codes are primarily outgoing access codes.

## Authorization Codes

You can also administer authorization codes to manage access to your system. You can then use CDR to track code use. Use these guidelines to manage your system's authorization codes.

- Assigning codes — Create random codes; do not allow them to follow a predictable pattern. Use the maximum code length allowed and assign a unique code to each person responsible for protecting the code.
- Changing codes — Change codes often.
- Deleting codes — Delete codes when they are no longer needed.
- Monitoring use — Use CDR reports to analyze code use.

## Alternate Facility Restriction Levels

Consider changing FRLs with AFRL after normal business hours to restrict where calls can be made over your facilities. Take care, however, not to restrict callers from summoning emergency services after hours.

## Class of Restriction

The COR of an authorization code supersedes that of a barrier code.

- Time of Day Routing — Controlled by the time-of-day entries in COR or by the partition.
- Toll Restriction and Analysis — Controlled by COR.
- Trunk Access Code — Interacts with toll restriction. You can translate your switch so that users can make toll calls via Alternate Route Selection (ARS) without using a trunk access code.
- Trunk Administration — Remote Access trunks can be restricted.

See the *BCS Products Security Handbook* for additional steps to secure your system and to find out about obtaining security information on a regular basis.



## Logoff Notification

Use Logoff Notification when Remote Access is enabled, but not actively used. Logoff Notification notifies you at logoff that Remote Access is enabled. It guards against inadvertently leaving Remote Access active and can also alert you to unauthorized feature activation. Logoff Notification is administered by login ID.

## End-user procedures

Users can access the system, group, and enhanced Abbreviated Dialing lists via the remote-access trunk. To set up an Abbreviated Dialing list on a remote-access trunk, complete the following steps:

1. Set up the Abbreviated Dialing list on the Console form.
2. Administer the Abbreviated Dialing list entries.
3. Dial into the system over the remote-access trunk.
4. If a barrier code and authorization code are administered, dial them.
5. Dial the feature access code followed by the dial code of the list entry.

## Considerations

- Ringback Queuing and Automatic Callback cannot be used on a Remote Access call since the system does not have access to the calling (outside) number.
- Any feature requiring recall dial tone (for example, Hold and Transfer) cannot be accessed remotely.
- The Remote Access caller must use a touch-tone voice terminal, or equivalent.
- After a DTDM's baud rate is changed from 9600 to 1200, the DTDM cannot be accessed by Remote Access until an internal call is made to the DTDM.

## Interactions

- Authorization Codes  
When a Remote Access caller dials the assigned Remote Access extension and connects to the system, the system may request the caller to dial an authorization code in addition to a barrier code. Dial Tone between the barrier code and authorization code is optional. Calling privileges associated with the COR assigned to the authorization code supersede those assigned to the barrier code.
- Class of Restriction  
COR restrictions do not block access to the Remote Access feature.

- Integrated Services Digital Network Primary Rate Interface

A problem may exist when attempting to make a Remote Access call via a public and private trunk. For example, a caller dials 957-5730. The caller receives the beep-beep tones for Remote Access, and dials the barrier code. At this point, the caller may still hear the system dial tone, indicating that the digits are *not* being received by PBX#1. To correct the problem, change the UDP table on PBX#2 to give the extension its own RNX of 555.

- Night Service

The Remote Access extension can be specified as the Night Service extension on an incoming, non-DID, trunk group.

## Restricted/Unrestricted Call Lists

---

Restricted/Unrestricted Call Lists controls outgoing call access.

### How to administer Restricted/Unrestricted Call Lists

---

#### Required forms

---

| Form                 | Field           | Page                  |
|----------------------|-----------------|-----------------------|
| Toll Analysis        | ■ Dialed String | <a href="#">5-299</a> |
|                      | ■ Min/Max       |                       |
|                      | ■ RCL           |                       |
|                      | ■ UCL (1-10)    |                       |
| Class of Restriction | ■ RCL           | <a href="#">5-72</a>  |
|                      | ■ UCL (1-10)    |                       |

---

#### Detailed description

---

DEFINITY ECS uses call lists to complete or deny outgoing calls. There can be one restricted call list (RCL) and up to 10 unrestricted call lists (UCL). The Class of Restriction (COR) is assigned to the calling facility. It is checked against the RCL and UCLs.

UCLs are checked when:

- COR is "all-toll" or "tac-toll"
- COR UCL field references one or more UCLs

The call completes if the COR is associated with a UCL whose dialed string matches the dialed number and the COR is not associated with the RCL.

The call is denied if the COR is associated with the RCL and the dialed string matches a RCL dialed string. The caller receives intercept treatment. The RCL takes precedence over the UCL.

The following Authorization Check Flowchart depicts the order of call-processing functions that occur as a result of user dialed numbers and associated entries on the Toll Analysis form and the caller's COR form.

#### 4 Basic Features

##### *Restricted/Unrestricted Call Lists*

Page 4-516

Checks are made as follows:

1. The first check determines if the dialed string is associated with the `RCL` (Restricted Call List) on the Toll Analysis form. If it is, the `RCL` field on the COR form associated with the caller's station is checked. If the field is `y`, the call is denied; otherwise, checking continues.
2. The next check determines if the `Calling Party Restriction` field on the COR form is **all-toll** or **tac-toll**. If it is, checking continues; otherwise the call is allowed.
3. The next check determines if the dialed string is associated with the `Toll List` on the Toll Analysis form. If it is, checking continues; otherwise, the call is allowed.
4. The next check determines if the dialed string is associated with a Unrestricted Call List number on the Toll Analysis form. If it is, the COR form is checked to determine if the UCL number is entered on the `Unrestricted Call List` field on the form. If it is, the call is allowed; otherwise, the call is denied.

In summary, calls from facilities are processed based on the COR assigned the facility, the COR's association with the System's RCL, UCL, and Toll List, and the specific digits dialed.

4 Basic Features

Restricted/Unrestricted Call Lists

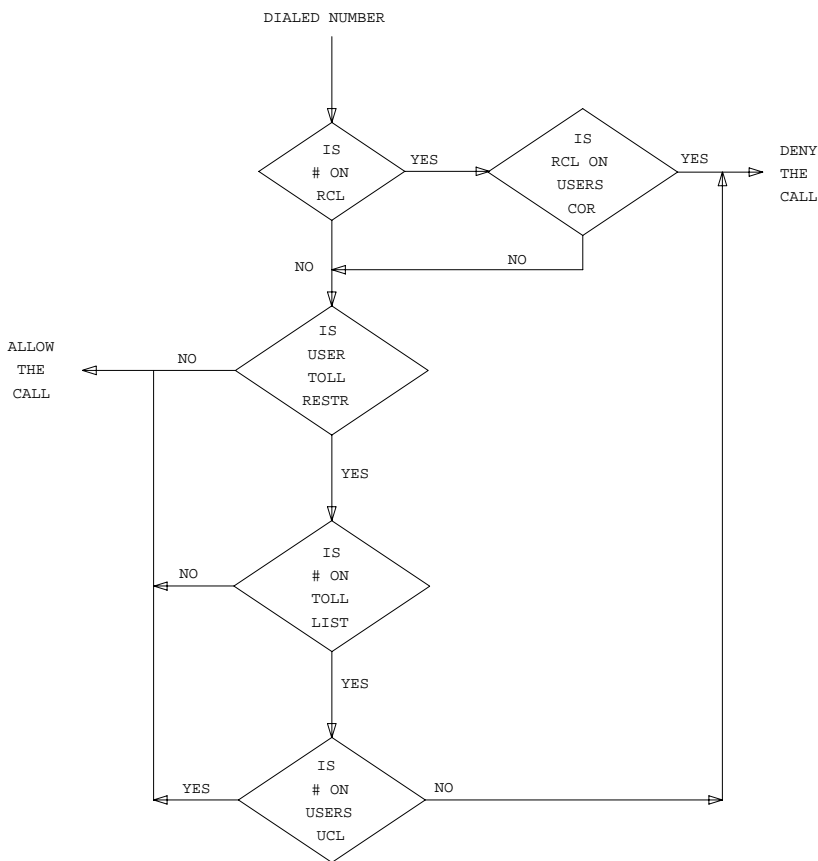

THIS FLOWCHART DOES NOT REFLECT ANY FEATURE INTERACTIONS THAT MIGHT TAKE PLACE, SUCH AS WITH AUTHORIZATION CODES

Figure 4-5. Authorization Check Flowchart

Interactions

None

## Restriction — Controlled

---

Controlled Restrictions allow a voice-terminal user with console permission to activate or deactivate specific restrictions.

### How to administer Controlled Restrictions

---

#### Required forms

---

| Form                              | Field   | Page                  |
|-----------------------------------|---|-----------------------|
| Feature Access Code (FAC)         | ■ User Control Restrict Activation and Deactivation   | <a href="#">5-113</a> |
|                                   | ■ Group Control Restrict Activation and Deactivation  |                       |
| Feature-Related System Parameters | ■ Controlled Outward Restriction Intercept Treatment  | <a href="#">5-123</a> |
|                                   | ■ Controlled Termination Restriction (Do Not Disturb) |                       |
|                                   | ■ Controlled Station-to-Station Restriction           |                       |

---

### Detailed description

---

Use Controlled Restriction to administer the following restrictions:

- **Outward** — The voice terminal cannot place calls to the public network.
- **Total** — The voice terminal cannot place or receive calls. (Allowed calls include calls to a remote-access extension, terminating-trunk transmission tests, and Emergency Access to Attendant calls.)  
Direct Inward Dialing (DID) calls are routed to the attendant or a recorded announcement. All other calls receive intercept tone.
- **Termination** — The voice terminal cannot receive any calls. Incoming calls are routed to the attendant, are redirected via Call Coverage, or receive intercept treatment.
- **Station-to-Station** — The voice terminal cannot place or receive station-to-station calls.

To activate Controlled Restriction:

1. Dial the group or extension feature access code.

## 4 Basic Features

### Restriction — Controlled

Page 4-519

2. Dial the number for the type of restriction desired:
  - 1 for outward
  - 2 for total
  - 3 for termination
  - 4 for station-to-station
3. Dial the voice-terminal extension (Attendant Control — Extension) or the Class of Restriction (COR) for a group of voice terminals (Attendant Control — COR).

## Considerations

---

- All voice terminals with the same COR are affected by a group restriction. When a call is placed, both individual and group restrictions are checked.

## Interactions

---

- Call Coverage  
Controlled Restrictions are not checked for covering users.
- Call Forwarding  
Controlled Restrictions for the forwarded-to extension are checked when Call Forwarding All Calls is active.
- Class of Restriction  
COR is checked when a call is authorized.
- Priority Call  
If a station user or a Station-to-Station Restricted user activates priority calling before they dial another station, they receive intercept tone. They receive this tone whether you set `Controlled Station to Station Restriction` on the Feature-Related System Parameters form to **y** or to **n**.
- Uniform Call Distribution  
Calls dialed through the UDP are not restricted by Outward Restriction.

## Ringback Queuing

---

Ringback Queuing places outgoing calls in an ordered queue (first-in, first-out) when all trunks are busy. The voice-terminal user is automatically called back when a trunk becomes available.

### How to administer Ringback Queuing

---

#### Required forms

| Form                              | Field  | Page                  |
|-----------------------------------|--|-----------------------|
| Trunk Groups                      | ■ Queue Length                                       | <a href="#">7-115</a> |
| Feature-Related System Parameters | ■ Automatic Callback-No Answer Timeout Interval      | <a href="#">5-123</a> |
| Feature Access Code (FAC)         | ■ Automatic Callback Activation/ Deactivation        | <a href="#">5-113</a> |
| Station (multiappearance)         | ■ Buttons/Feature Button Assignments<br>— auto-cback | <a href="#">6-14</a>  |

#### NOTE:

Automatic Callback and Ringback Queuing share the same intervals, codes, and buttons.

### Detailed description

---

If a multiappearance voice-terminal user has an idle Automatic Callback button and tries to access an all-trunks-busy trunk group, Ringback Queuing is activated automatically. The lamp associated with the Automatic Callback button lights and confirmation tone is heard.

Ringback Queuing is automatic for a single-line voice terminal. After dialing is complete, the user hears confirmation tone if the queue is available. No action is required.

The callback call is automatically placed to the terminal when a trunk becomes available. When the user answers the callback call (designated by a 3-burst alerting signal), the original call automatically continues. Redialing is not required.

Queuing can be specified for any non-DCS outgoing-only trunk group, or for the outward direction of a non-DCS 2-way trunk group.



## Considerations

---

- Queuing can reduce the number of trunks required.
- A multiappearance voice terminal can have one callback call associated with each Automatic Callback button assigned to the terminal.
- A single-line voice terminal can have only one automatic-callback call waiting at a time.
- Queue requests are canceled when:
  - A trunk is not available within 30 minutes.
  - The user does not answer the callback call within the administered interval.
  - The voice terminal is busy when the callback call is attempted.
  - The user dials the Ringback Queuing cancellation code or presses the Automatic Callback button associated with the queued call.
- Incoming tie-trunk calls cannot queue on an outgoing trunk group. The system does not know the calling number and cannot originate the callback call.
- The system checks the busy/idle status of the trunk group just once. If all trunks are busy, the call queues, even if a trunk has become available by the time the caller has completed dialing. This occasionally results in the caller being called back immediately after receiving confirmation tone and going on-hook.
- A trunk may appear to be available, yet outgoing calls are queued. The trunk is not free, because it is reserved for a previous Automatic Callback request.

## Interactions

---

- Automatic Callback

If you provide Ringback Queuing, you must also provide Automatic Callback.
- Automatic Route Selection

If a multiappearance voice-terminal user has an Automatic Callback button, makes an ARS call, and all trunks are busy, Ringback Queuing is activated automatically.
- Bridged Call Appearance

Ringback Queuing is not provided on calls placed from a bridged call appearance.
- Call Coverage

Callback calls do not redirect, even if Send All Calls is active.

- Call Forwarding All Calls  
Callback calls are not forwarded.
- Call Pickup  
Callback calls cannot be picked up.
- Conference or Transfer  
A single-line voice terminal cannot receive a callback call while it has a call on hold. It can have only one active call at a time.
- Internal Automatic Answer  
Automatic calls generated by Ringback Queuing are not eligible for IAA.
- Remote Access  
Callback calls cannot be made to Remote Access users because the system does not know the calling number.

## Ringer Cutoff

Ringer Cutoff allows multiappearance voice-terminal users to turn audible ringing signals on and off. This feature does not affect visual alerting.

When this feature is enabled, only Priority ring (by default 3-burst), Redirect Notification, Intercom ring, and manual signaling ring at the voice terminal. Internal and external calls do not ring.

### How to administer Ringer Cutoff

#### Required forms

| Form                      | Field   | Page                 |
|---------------------------|---|----------------------|
| Station (multiappearance) | <ul style="list-style-type: none"> <li>■ Redirect Notification</li> <li>■ Button/Feature Button Assignments<br/>— ringer-off</li> </ul> | <a href="#">6-14</a> |

### Detailed description

The following table summarizes which calls are affected by Ringer Cutoff.

| Call Type                        | Redirect notification is |           |
|----------------------------------|--------------------------|-----------|
|                                  | Inactive                 | Active    |
| Voice terminal to voice terminal | no                       | ring ping |
| Attendant to voice terminal      | no                       | ring ping |
| Internal tie to voice terminal   | no                       | ring ping |
| APLT trunk to voice terminal     | no                       | ring ping |
| Trunk to voice terminal          | no                       | ring ping |
| Priority call to voice terminal  | yes                      | yes       |
| Intercom call to voice terminal  | yes                      | yes       |
| Manual signaling                 | yes                      | yes       |

#### NOTE:

If Call Coverage is set to Cover All and Ringer Cutoff and Redirect Notification are both active, then Redirect Notification is received. If Redirect Notification is not active, no audible alerting is received.

A user may not wish to be disturbed by the arrival of incoming calls, yet not want calls to be redirected immediately to coverage. For example, an executive may want a secretary to answer calls before they redirect to coverage. The bridging user (the secretary) is not affected by the executive's activation of Ringer Cutoff.

To activate Ringer Cutoff, the user presses the voice-terminal Ringer-Cutoff button. The associated status lamp lights. Ringing is silenced. If Ringer Cutoff is activated while the voice terminal is ringing with an internal or external call, the ringer is silenced.

To deactivate Ringer Cutoff, the user presses the Ringer-Cutoff button again. Ringing returns to audible. If the selected call is active, other incoming calls do not start ringing. If the selected call is in the ringing state, the ringer becomes audible.

## Considerations

---

- A multiappearance voice terminal may have just one Ringer Cutoff button.
- If a primary extension and all other users with bridged appearances of the primary extension activate Ringer Cutoff, an incoming call silently alerts all of the terminals and then redirects to coverage.

## Interactions

---

- Automatic Callback  
If Ringer Cutoff is active, an Automatic Callback call returns to the user's voice terminal with the normal 3-burst ring.
- Bridging  
A bridging user is not affected by a primary extension's activation of Ringer Cutoff. Nor is the primary extension affected by the bridging user's activation of Ringer Cutoff.
- Call Forwarding All Calls  
If Ringer Cutoff and Call Forwarding All Calls are active, the user receives redirect notification, if you set `Redirection Notification` to **y** for the extension.
- Distinctive Ringing  
Ringer Cutoff turns off only the distinctive ringing of internal and external calls. Intercom ringing, priority ringing, redirect notification, and manual signaling are not turned off.
- Intercom (Automatic and Dial)  
If Ringer Cutoff is active, intercom calls still ring the user's voice terminal.

- Manual Signaling  
If Ringer Cutoff is active, Manual Signaling still rings the user's voice terminal.
- Ringback Queuing  
If Ringer Cutoff is active, the return call for Ringback Queuing still rings the user's voice terminal with a 3-burst alerting signal.
- Priority Calling  
If Ringer Cutoff is active, priority calls still ring at the user's voice terminal.
- Send All Calls  
When Ringer Cutoff and Send All Calls are both active, the user receives redirect notification, when `Redirection Notification` is set to `y` for that extension.

## Ringling — Abbreviated and Delayed

---

Ringling — Abbreviated and Delayed allows you to assign one of four ring types to each call appearance on a voice terminal. Whatever treatment is assigned to a call appearance is automatically assigned to each of its bridged call appearances.

### How to administer Ringling — Abbreviated and Delayed

---

#### Required forms

---

| Form                              | Field  | Page                  |
|-----------------------------------|--|-----------------------|
| Feature-Related System Parameters | ■ Auto Abbreviated/Delayed Transition Interval (rings) | <a href="#">5-123</a> |
| Station                           | ■ Per Button Ring Control<br>■ Feature Buttons         | <a href="#">6-14</a>  |

---

### Detailed description

---

Ring types fall into two categories:

- Those that alert consistently and don't change:
  - Ringling, in which the lamp flashes and audible ringing occurs
  - Silent ringing, in which the lamp flashes and audible ringing does not occur
- Those that transition from one ringing state to another:
  - Abbreviated ringing, in which ringing continues for as many cycles as specified by the automatic abbreviated/delayed transition interval and then changes to silent alerting
  - Delayed ringing, in which visual alerting continues for as many cycles as specified by the automatic abbreviated/delayed transition interval and then changes to ringing

For a station with call appearances that have either abbreviated or delayed ringing, an abbreviated-ring button associated with that station's extension can be assigned on a different station. When one of those call appearances is being alerted, pressing the button forces immediate transition of the alerting — that is, from ringing to silence or from silence to ringing.

## 4 Basic Features

### *Ringling — Abbreviated and Delayed*

Page 4-527

This feature is most useful in bridging situations in which some users want to be:

- Audibly alerted to a call immediately upon its arrival
- Audibly notified if the call has not been answered within a specified number of rings or if they have indicated.
- Able to stop the audible alerting if the call is not being answered by the principal and the user is not able to answer the call.

Because ring type can be specified on a per-station basis, mixing ring-type specifications within a station's access to a particular extension is possible.

For Ringling — Abbreviated and Delayed, each call appearance must be:

- Assigned a ring type
- Administered to transition when the:
  - Abbreviated/delayed transition interval is reached or when the voice-terminal user presses the abbreviated ring button
  - Voice-terminal user presses the abbreviated ring button, regardless of the abbreviated/delayed transition interval

## Ring options

You assign one of the following ring types to each line button.

- Abbreviated Ring  
A call rings the terminal until the automatic or manual abbreviated/delayed transition occurs. Then the call silently alerts the terminal.
- Delayed Ring  
A call silently alerts the terminal until the automatic or manual abbreviated/delayed transition occurs. Then the call rings the terminal.
- No Ring  
A call silently alerts the terminal and does not transition.
- Ring  
A call rings the terminal and does not transition.

## End user operation

- You can administer Ringling — Abbreviated and Delayed to transition automatically and manually for each call appearance. Automatic transition does not require any user action. The transition occurs based on the administered abbreviated/delayed transition interval.
- Manual transition does require user action. Users press the abbreviated-ring button on their terminal. This action forces the abbreviated/delayed transition to occur for all calls at the administered extension. Calls to other extensions that alert the terminal are not affected.

## 4 Basic Features

### *Ringling — Abbreviated and Delayed*

Page 4-528

## **Considerations**

---

- You cannot assign Ringling — Abbreviated and Delayed to a system console.
- At any one time, a voice terminal can have separate calls visually alerting and audibly alerting.
- If you administer a call appearance for delayed or abbreviated ringling and do not administer the call appearance for automatic abbreviated/delayed transition, assign an abbreviated-ring button to the call appearance extension on that terminal for that call appearance's extension.
- You can assign Ringling — Abbreviated and Delayed to analog stations, whether they are administered as a primary call appearance or a bridged call appearance set. However, because analog stations cannot visually alert, a user may unexpectedly answer an incoming call while intending to originate a call.

## **Interactions**

---

When one of the following features attempts to alert a station, the ringling presented to the user is influenced by the ring-type translations specified for Ringling — Abbreviated and Delayed. Undesirable feature operation may result if these translations are set inappropriately. For example, a ring type of no ringling results in the station not being alerted audibly.

- Automatic Callback
- Automatic Call Distribution (ACD)/Hunting
- Automatic Circuit Assurance (ACA)
- Busy Verification of Terminals
- Consult
- Night Service (Unattended Console Service)
- Personal Central Office Line (PCOL)
- Priority Calling
- Ringback Queuing
- Security Violation Notification (SVN)
- Terminating Extension Group (TEG)
- Active Station Ringling

This feature determines when a station is audibly alerted. Active Station Ringling determines if the ring is to be permitted, shortened to a single ring cycle, or suppressed. Single ring timing begins when the call rings at each station that has access to the appearance. In this way, even though



## 4 Basic Features

### *Ringling — Abbreviated and Delayed*

Page 4-529

a call has been alerting other ringing or abbreviated-ringing stations for more than one ring cycle, the delayed-ringing stations have a full cycle of ring beginning at the abbreviated/delayed transition.

- Administration Without Hardware

It is possible to assign Ringling — Abbreviated and Delayed to stations administered without a specified port. When stations are associated with ports, these assignments become effective.

- Attendant Console

Ringling — Abbreviated and Delayed cannot be assigned to an attendant console.

- Call Coverage

If the number-of-rings interval for coverage is shorter than the automatic transition interval, a call redirects to coverage before audibly alerting a call appearance that has delayed ringing. However, timing continues for the automatic transition interval in case no coverage point is available and the call continues to alert at the station.

When a call is immediately redirected to coverage (because of Cover Active, Cover All, Cover Busy, or Send All Calls), the Ringling — Abbreviated and Delayed feature has no effect.

- Call Forwarding — Busy/Don't Answer

When a call is forwarded because it is not answered in the specified time, the call stops alerting the station and is not affected by the Ringling — Abbreviated and Delayed feature. However, timing continues for the automatic transition interval in case forwarding fails and the call continues to alert at the station.

If the call forward don't answer interval is shorter than the automatic transition interval, the call redirects to the forwarded-to extension before ringing a station with a ring type of delayed ringing.

- Call Vectoring — Expert Agent Selection — Logical Agents

Calls routed to a logical agent use the translations for the Ringling — Abbreviated and Delayed feature of the station being used by the agent.

- Data Extension Calls

Data Extension calls are not affected by the ring values, but continue to be directed by the bridged call alerting administration.

- Distinctive Alerting (Ringling)

The Ringling — Abbreviated and Delayed feature affects all audible alerting using the 1-, 2-, or 3-burst pattern.

- Hospitality Features — Do Not Disturb

The Do Not Disturb feature takes precedence over the Ringling — Abbreviated and Delayed feature in blocking ringing to the station.

## 4 Basic Features

### *Ring*ing — *Abbreviated and Delayed*

Page 4-530

- Integrated Services Digital Network — World Class Basic Rate Interface

Several of the protocol variations supported by the World Class BRI feature do not permit the messaging required for control of the station's ringer by Ringing — Abbreviated and Delayed. In this case, ring type is forced to a value of ring.

- Multiappearance Preselection and Preference

The system automatically selects any alerting call on a station whether or not it is ringing if the `Per Button Ring Control` field is set to **n**. If the field is set to **y**, it selects only audibly ringing calls.

- Off-Premises Station and Off-Premises Extension Lines

The ring type assigned to OPS and OPX lines are forced to a value of ring.

- PCOL Calls

PCOL calls are not affected by the ring values, but continue to be directed by the bridged call alerting administration.

- Redirection Notification

If Redirection Notification is enabled, terminals only receive redirection notification if the alerting button or the first call appearance has an assigned ring value of ring or abbreviated ring. Bridged terminals only receive redirection notification for a forwarded call if the `Per Button Ring Control` field is set to **y** and the call appearance has an assigned ring value of ring or abbreviated ring.

- Ringer Cutoff

Ringer Cutoff takes precedence over Ringing — Abbreviated and Delayed. Pressing the ringer cutoff button turns off audible alerting at all call appearances and bridged appearances on the terminal.

- Temporary Bridged Appearances

Temporary Bridged Appearances are not affected by the Ringing — Abbreviated and Delayed feature. They always silently alert a station.

- Terminating Extension Group Calls

TEG calls are not affected by the ring values, but continue to be directed by the bridged call alerting administration.

- Voice Mail Systems

Voice mail systems may look for ringing applied to a port to trigger call answer. Undesirable adjunct operation may result if ring-type translations are inappropriately set for ports serving these adjuncts.

## Security Violation Notification

---

Security Violation Notification (SVN) allows you to set security-related parameters and to receive notification when the limits that you have established are exceeded. You can run reports related to invalid access attempts. You can also disable a login ID or remote access authorization that is associated with a security violation.

When a security violation occurs, SVN notifies a designated referral point. This can be an attendant console, a display-equipped voice terminal, or a voice terminal without display for SVN referral calls with announcements.

The system monitors and reports on the following types of security violations:

- Login violations
- Remote access barrier code violations
- Authorization code violations
- Station security code violations

DEFINITY ECS provides the option to log a major alarm if a security violation occurs involving a Lucent Technologies services login ID. Lucent Technologies is responsible for retiring the alarm.

*DEFINITY ECS Release 6 System Monitoring and Reporting* provides more information on how to run reports, and respond to security violations.

### How to administer SVN

---

**Table 4-84. Required forms**

| Form                               | Field  | Page                  |
|------------------------------------|--|-----------------------|
| Security-Related System Parameters | ■ All  | <a href="#">5-266</a> |
| Station (multi-appearance)         | ■ Button Assignments (if needed)<br>— asvn-halt<br>— lsvn-halt<br>— rsvn-halt<br>— ssvn-halt | <a href="#">6-14</a>  |

---

*Continued on next page*

**Table 4-84. Required forms — Continued**

| Form                              | Field   | Page                  |
|-----------------------------------|---|-----------------------|
| Remote Access                     | ■ Disable Following A Security Violation?               | <a href="#">5-258</a> |
| Login Administration              | ■ Disable Following A Security Violation?               | <a href="#">2-7</a>   |
| Recorded Announcements (optional) | ■ All — one announcement for each type of referral call | <a href="#">5-26</a>  |

## Detailed description

To effectively monitor the security of your system, you need to know how often both valid and invalid attempts at system entry are normally made. Then you will know if the number of invalid attempts is unusually high. A significant increase in such attempts can mean the system is being compromised.

### NOTE:

It is recommended that you print and clear the security-violation measurement reports at least once a month. In a busy system, once a week is not too frequent.

## Security violation thresholds and notification

As an example, you may determine that during a forty-hour week, it's normal for users to submit about 1,000 valid barrier codes and 150 invalid barrier codes; that is, about 3.75 invalid barrier codes are submitted per hour.

With this information, you may decide to declare that a security violation occurs during any hour in which 8 invalid barrier codes are submitted. If you know that during an 8-hour period, about 30 invalid codes are submitted, you might set the threshold to count a security violation when 40 invalid codes are submitted within eight hours.

You can administer SVN to place a referral call to the location of your choice whenever the established thresholds are reached.

Invalid attempts accumulate at different rates in the various security arenas (login, authorization code, remote access, and station security code), depending on feature usage and the number of users on a server. For this reason, you administer thresholds separately for each type of violation.

## Sequence of events

The following is the sequence of events that occur when a SVN is enabled and a security violation is detected:

1. SVN parameters are exceeded (the number of invalid attempts permitted in a specified time interval is exceeded).
2. A SVN referral call (with announcements, if assigned) is placed to a designated point, and SVN provides an audit trail containing information about each attempt to access the switch.
3. SVN disables a login ID or Remote Access following the security violation.
4. The login ID or Remote Access remains disabled until re-enabled by an authorized login ID, with the correct permissions.

## Reporting

The system reports information about security violations in the following ways:

- **In real time** — you can use the **monitor security-violations** command to monitor security violations as they may be occurring. Enter this command, followed by the type of security violation you want to monitor (logins, remote-access, authorization-codes, or station-security-codes).
- **On an immediate basis** — when a security violation occurs, the system sends a priority call to a designated referral point (attendant console or voice terminal). Thus, there is some chance of apprehending the violator during the attempted violation.

Upon notification, you can request the Security Violations Status Reports, which show details of the last sixteen security violations of each type. The Barrier Code and Authorization Code reports also include the calling party number from which the attempt was made, where available.

- **On a historical basis** — the number of security violations of each type, as well as other security measurements, are collected and displayed in the Security Violations Summary and Detail reports. These reports show summary information since the counters were reset by the **clear measurements security-violations** command or since system initialization. They do not show all aspects of the individual security violations.

## SVN- halt buttons

You can administer buttons for the notification extension to stop notification calls. However, this may pose a security risk. Do not use these buttons if you do not really need them.

To find out what svn-halt buttons exist in the system, enter the command:

**display svn-button-location**

The SVN Button Locations screen appears.

```
-----  
-----  
SVN BUTTON LOCATIONS  
  
LOGIN SECURITY VIOLATIONS  
  
Name: Administrator_____  
Extension: 81234_____  
  
REMOTE ACCESS SECURITY VIOLATIONS  
  
Name: Administrator_____  
Extension: 81234_____  
  
AUTHORIZATION CODE SECURITY VIOLATIONS  
  
Name: Administrator II_____  
Extension: 81235_____  
  
STATION SECURITY CODE VIOLATIONS  
  
Name: Administrator II_____  
Extension: 81235_____  
  
-----  
-----
```

#### Screen 4-5. SVN Button Locations

### SVN Referral Call With Announcement

The SVN Referral Call with Announcement option has the capacity to provide a recorded message identifying the type of violation accompanying the SVN referral call. Using Call Forwarding, Call Coverage, or Call Vector Time-of-Day Routing (to route to an extension or a number off the switch), SVN referral calls with announcements can terminate to a point on or off the switch.

Use of other means to route SVN referral calls to alternate destinations are not supported at this time. An attempt to use an alternate method to route SVN referral calls may result in a failure to receive the call or to hear the announcement.

### Dealing with security violations

When a security violation has occurred, there are steps that you can take to ensure that this same attempt is not successful in the future.

## Enable/disable a login ID

The Login Administration form `Disable Following a Security Violation` field is used to set the SVN parameters for a single login. When set to **y**, SVN disables the specified login ID if it is involved in a security violation. The `Disable a Login ID Following a Security Violation` field is dynamic and only appears when the login component of SVN is enabled.

To enable a login ID that has been disabled by a security violation, or disabled manually with the command **disable login**:

1. Log in to the switch using a login ID with the correct permissions.
2. Enter the command **enable login <login ID>**.

To disable a login ID:

1. Log in to the switch using a login ID with the correct permissions.
2. Enter the command **disable login <login ID>**.

## List the status of a login ID

To list the status of a login ID:

1. Log in to the switch using a login ID with the correct permissions.
2. Enter the command **list login**.

You see a display indicating the status of the specified login ID. A login ID status can be listed as:

- Disabled — The login ID was disabled manually using the **disable login** command.
- Svn-disabled — A security violation was detected for that login ID and the login was disabled by the SVN feature.
- Active — The login ID is currently logged in.
- Inactive — The login ID is not logged in.

## Enable/disable Remote Access

The Remote Access form `Disable Following a Security Violation` field is used to set the SVN parameters for Remote Access on a system-wide basis. When set to **y**, SVN disables Remote Access for the entire system if a remote access security violation occurs. The `Disable Following a Security Violation` field is dynamic and only appears when the remote access component of SVN is enabled.

## 4 Basic Features

### Security Violation Notification

Page 4-536

To enable remote access that has been disabled following a security violation, or disabled manually with the command **disable remote access**:

1. Log in to the switch using a login ID with the correct permissions.
2. Enter the command **enable remote-access**.

To disable Remote Access:

1. Log in to the switch using a login ID with the correct permissions.
2. Enter the command **disable remote-access**.

## View the status of Remote Access

You can check the status of remote access and barrier codes.

To list the status of a login ID:

1. Log in to the switch using a login ID with the correct permissions.
2. Enter the command **status remote-access[print]**.

This command shows whether remote access is enabled or disabled, the existing barrier codes, their expiration dates, and their status. See [“Remote Access” on page 5-258](#) for more information.

## Considerations

---

- You may only administer one referral destination per system for each type of violation.
- Exercise caution when administering bridged appearances for stations that are used as SVN referral destinations. SVN referral calls terminating to bridged appearances *must* be accompanied by an announcement message or *must* route to bridge appearances equipped with a display module. SVN referral calls that do not have an announcement and terminate to a bridged appearance not having a display will not provide an indication of the nature of the call.
- An authorization code violation with remote access generates two SVNs -- one displaying “authorization code violation” and one displaying “barrier code violation,” even though the correct barrier code was input. These two displays help you determine that the violation took place in the context of a remote access attempt, not an attempt to place an outgoing call to an ARS trunk.



## **Interactions**

---

- **Call Coverage, Call Forwarding, and Call Pickup**  
These features are supported for SVN only if you use recorded announcements.
- **Centralized Attendant Services**  
CAS attendants cannot receive referral calls from branch locations.
- **DCS**  
SVN does not support referral calls across a DCS network.
- **Priority Calling**  
All SVN referral calls are priority calls.

## Send All Calls

---

Send All Calls allows users to temporarily direct all incoming calls to coverage regardless of the assigned call-coverage redirection criteria. Covering users can temporarily remove their voice terminals from the coverage path.

### How to administer Send All Calls

---

#### Required forms

---

| Form                      | Field  | Page                  |
|---------------------------|--|-----------------------|
| Feature Access Code (FAC) | ■ Send All Calls Activation and Deactivation     | <a href="#">5-113</a> |
| Station (multiappearance) | ■ Button/Feature Button Assignments — send-calls | <a href="#">6-14</a>  |
| Coverage Path             | ■ DND/SAC/Goto Cover                             | <a href="#">5-94</a>  |

### Interactions

---

- Automatic Call Distribution  
With Send All Calls active, an ACD agent is still available for ACD calls.
- Automatic Callback  
Send All Calls does not work with Automatic Callback calls.
- Call Coverage  
Refer to Call Coverage in this document to learn about that feature and its impact on Send All Calls.
- Direct Department Calling/Uniform Call Distribution  
With Send All Calls active, a member of a DDC/UCD hunt group is not available for calls.
- Internal Automatic Answer  
IAA does not apply to calls to the original called extension when that extension has Send All Calls active.
- Night Service  
With the console in Night Service and Send All Calls active, a call covers after the “no answer” ring interval.

## Service Observing

---

Service Observing allows a specified user, such as a supervisor, to observe or monitor another user's calls. In this section, "observer" refers to the supervisor who is observing calls. "Agent" refers to the terminal, attendant, or logical agent being observed. A vector directory number (VDN) call can also be observed. Observers can observe in listen-only or listen-and-talk mode.

Note that you set up Service Observing to observe a particular extension, not all calls to all extensions at a terminal.

 **NOTE:**

Service Observing may be subject to federal, state, or local laws, rules, or regulations or require the consent of one or both of the call parties. Familiarize yourself and comply with all applicable laws, rules, and regulations before using this feature.

### How to administer Service Observing

---

#### Required forms

---

| Form                                  | Field   | Page                  |
|---------------------------------------|---|-----------------------|
| System Parameters<br>Customer-Options | <ul style="list-style-type: none"> <li>■ Service Observing (Basic) — for basic or Logical Agent ID observing</li> </ul>   | <a href="#">5-277</a> |
|                                       | <ul style="list-style-type: none"> <li>■ Service Observing (Basic) and Service Observing (Remote/By FAC) — for remote observing or observing via feature access code</li> </ul> |                       |
|                                       | <ul style="list-style-type: none"> <li>■ Service Observing (Basic) and the Service Observing (VDNs) — for VDN observing</li> </ul>  |                       |
|                                       | <ul style="list-style-type: none"> <li>■ Vectoring (Prompting) — for vector-initiated observing</li> </ul>  |                       |
| Class of Restriction                  | <ul style="list-style-type: none"> <li>■ Can Be Service Observed</li> </ul>   | <a href="#">5-72</a>  |
|                                       | <ul style="list-style-type: none"> <li>■ Can Be Service Observer</li> </ul>   |                       |
|                                       | <ul style="list-style-type: none"> <li>■ Service Observing COR Table</li> </ul>   |                       |

---

*Continued on next page*

**Required forms — Continued**

| Form                              | Field  | Page                  |
|-----------------------------------|--|-----------------------|
| Feature-Related System Parameters | ■ Service Observing Warning Tone   | <a href="#">5-123</a> |
|                                   | ■ Expert Agent Selection (Logical Agent ID)  |                       |
| Station (multiappearance)         | ■ Button/Feature Button Assignment (basic, VDN, Logical Agent ID)                  | <a href="#">6-28</a>  |
|                                   | — serv-obsrv   |                       |
| Feature Access Code (FAC)         | ■ Service Observing Listen Only Access Code (remote/by FAC, VDN, Logical Agent ID) | <a href="#">5-113</a> |
|                                   | ■ Service Observing Listen/Talk Access Code (remote/by FAC, VDN, Logical Agent ID) |                       |

- Class of Restriction form
  - On the agent's COR form, set `Can Be Service Observed` to **yes** to allow the extension to be observed.
  - On the observer's COR form, set `Can Be Service Observer` to **yes** to allow the extension owner to observe others' extensions.
  - On the observer's COR form, grant permission to observe specific CORs. On the Service Observing COR table, enter **y** next to the CORs to be observed.

**Detailed description**

To begin observing, the observer presses the Service Observing button plus the agent's extension number. Initially, the observer is in listen-only mode. The observer presses the Service Observing button to toggle between listen-only and listen/talk mode. The lamp indicates which mode the observer is in.

To deactivate Service Observing, the observer hangs up, selects another call appearance, or presses the disconnect or release button.

An observer can observe an agent who is not active on a call. The observer is in the wait state until the agent receives a call, then the observer is bridged onto the call.

You can administer a warning tone on each system to let agents and callers know when someone is observing a call. Before connection, the conference tone may add 2-3 seconds delay if enabled. The parties hear a 2-second, 440-Hz warning tone before an observer connects to a call, followed by a half-second burst of this tone every 12 seconds during observation.

### **Observing logical-agent IDs**

With EAS, an observer can observe agents based on their logical-agent ID rather than their physical voice terminal. The observer enters the logical-agent ID extension number of an agent, who must be logged in to a voice terminal. The observer can monitor every ACD, personal, and Direct Agent call delivered to or placed by the agent, including calls placed to the physical extension.

Only one observer can observe a physical terminal at one time. An observer cannot observe a logical agent ID extension at a physical terminal that is already being observed. Likewise, an observer cannot observe a physical extension that is being observed as a logical-agent ID extension.

### **Observing VDNs**

To observe a VDN, the observer enters a specific VDN extension and bridges onto calls (one call at a time) that have started vector processing for that VDN. The observer hears all tones, call prompting, caller dialing, announcements, music, and speech that the agent and caller hear. If an observer is in a COR administered to hear VDN of Origin announcements and has a VOA Repeat button, he or she can hear and replay VDN of Origin announcements.

The observer sees the name of the VDN, agent, or trunk as each is accessed in sequence by the VDN. For example, during vector processing the VDN name is displayed, but when the call connects to an agent, the agent name is displayed.

When the observer connects to a call in vector processing, the system maintains the connection until the call is disconnected or the observer hangs up, even if the call is routed or transferred externally. If the observer does not disconnect after one observed call is disconnected, the observer is connected to another call on the same VDN. Observing is listen-only as long as the call is in vector processing. Once the call is out of vector processing, an observer with listen/talk capability can talk as well as listen.

### **Observing remotely or by FAC**

Observers can observe calls from a remote location or local terminal using Service Observing FACs. When observing remotely, observers must use FACs. Different FACs are required for listen-only and listen/talk modes. When observing locally or remotely by FAC, the observer cannot toggle between modes. Physical extensions, logical-agent ID extensions, and VDNs can be observed remotely.

Remote observing is initiated through Remote Access or Call Vectoring.

- With Remote Access, an observer accesses a switch via a trunk group dedicated to Remote Access or via a DID to the Remote Access extension. Remote observing works with all types of DID trunks, including ISDN-PRI and tie trunks, and DCS over analog, T1, or PRI.
- With Call Vectoring, an observer accesses a switch by dialing a VDN extension or a central office (CO) trunk that has a VDN extension as its incoming destination. Using route-to commands, you can design a Service Observing vector to allow a VDN call to directly access a specific extension to be observed or a Service Observing dial tone. At the dial tone, observers can enter any extension that they are authorized to observe. The following is a simple example of a Service Observing vector.

```

1.wait-time 0 seconds hearing ringing
2.collect 5 digits announcement 2300
  ("please dial your 5- digit security code")
3.goto step 5 if digits = 12345
4.disconnect after announcement 2000
5.collect 1 digits announcement 2310
  ("enter 1 to observe sales, 2 to observe billing")
6.route-to number 113001 with cov n if digit = 1
  (11=listen-only observe, 3001="Sales" VDN)
7.route-to number 113002 with cov n if digit = 2
  (11=listen-only observe, 3002="Billing" VDN)
8.goto step 5 if unconditionally
    
```

You can combine Call Prompting and Call Vectoring to provide security and to limit observation. See *DEFINITY Enterprise Communications Server Call Vectoring/EAS Guide* for information about creating a Service Observing vector.

## Service Observing indicators

[Table 4-85](#) shows general Service Observing indicators that observers receive.

**Table 4-85. General Indications to Observer**

| Condition               | Button Lamp        | Tone   |
|-------------------------|--------------------|--|
| Not active              | Dark               | None   |
| Denied activation       | Broken flutter     | Intercept/busy/reorder                                       |
| Activated               | Steady/Winking     | Confirmation tone followed by silence or connection to call. |
| Observing (listen only) | Steady             | Hear call  |
| Observing (listen/talk) | Winking            | Hear/talk on call  |
| In wait state           | Flash              | None   |
| Denied observing        | Flash (wait state) | Silence/ineligible tone followed by silence                  |

Table 4-86 through Table 4-88 show the indicators that observers receive when they activate and use Service Observing. In these tables:

- Wait state means that the observer has activated Service Observing but there are no calls or a call cannot be observed. A call appearance is not reserved. The observer must have an idle call appearance available to be used by Service Observing when an observable call comes in.
- Ineligible tone is heard when an observed call becomes ineligible for observation. See [“Considerations” on page 4-547](#) for conditions that make a call ineligible. This tone is the “hold confirmation tone”— a rapid series of 5 short 440-Hz beeps. The observer does not hear this tone if the agent receiving the ineligible call hears zip tone.

**Table 4-86. Feedback When Activation Denied**

| Condition                                       | State  | Lamp           | Tone      |
|---|--------|----------------|-----------|
| No such extension                               | denied | broken flutter | intercept |
| Extension not observable                        | denied | broken flutter | intercept |
| Not allowed COR <sup>1</sup>                    | denied | broken flutter | intercept |
| Extension has Data Restriction                  | denied | broken flutter | intercept |
| Extension has Exclusion Active                  | denied | broken flutter | busy      |
| Extension has Data Privacy Active on call       | denied | broken flutter | busy      |
| Extension already observed                      | denied | broken flutter | busy      |
| Extension is an observer                        | denied | broken flutter | busy      |
| Extension being busy-verified                   | denied | broken flutter | reorder   |
| Extension has a 6-party conference              | denied | broken flutter | reorder   |
| COR doesn't allow SO activation                 | denied | broken flutter | intercept |
| Observe VDN not optioned                        | denied | broken flutter | intercept |
| Logical ID not logged In                        | denied | broken flutter | busy      |
| Activation to logical with physical observed    | denied | broken flutter | busy      |
| Activation to physical with logical ID observed | denied | broken flutter | busy      |
| Maximum VDNs being observed                     | denied | broken flutter | reorder   |

1. Extension COR cannot be observed or COR for observer calling permission does not allow observing the COR of extension to be observed.

**Table 4-87. Feedback When Activation Allowed — At Time of Activation**

| Condition                       | State      | Lamp               | Tone  |
|---------------------------------|------------|--------------------|---|
| Active-eligible call            | observing  | steady/<br>winking | confirmation tone followed by<br>connection to call |
| No active call                  | wait state | flash              | confirmation tone followed by<br>silence            |
| Call ineligible                 | wait state | flash              | confirmation tone followed by<br>silence            |
| Call has "No Observe" COR       | wait state | flash              | confirmation tone followed by<br>silence            |
| VDN call already being observed | wait state | flash              | silence   |

**Table 4-88. Feedback When Activation Allowed — After Observe Activated**

| Condition  | State          | Lamp    | Tone              |
|--|----------------|---------|-------------------|
| No active/eligible Call                          | wait state     | flash   | silence           |
| Call in 6-party conference                       | wait state     | flash   | silence           |
| Call already being observed                      | wait state     | flash   | silence           |
| Call is being busy-verified                      | wait state     | flash   | silence           |
| Call has Data Privacy active                     | wait state     | flash   | silence           |
| Call has Data Restriction                        | wait state     | flash   | silence           |
| Call has Exclusion Active                        | wait state     | flash   | silence           |
| Active-eligible call (in listen-only mode)       | SO listen      | steady  | hear call         |
| Active-eligible call (in listen/talk mode)       | SO listen/talk | winking | hear/talk on call |
| Press button while observing in listen-only mode | SO listen/talk | winking | hear/talk on call |
| Observer presses Release                         | not observing  | dark    | none              |
| Call has "No Observe" COR                        | wait state     | flash   | silence           |

*Continued on next page*



**Table 4-88. Feedback When Activation Allowed — After Observe Activated**  
— *Continued*

| Condition  | State                 | Lamp               | Tone                                |
|--|-----------------------|--------------------|-------------------------------------|
| VDN call already being observed                              | wait state            | flash              | silence                             |
| No active eligible call                                      | wait state            | flash              | silence                             |
| Eligible VDN call  | observing             | steady/<br>winking | hear call                           |
| Eligible VDN call (in vector processing)                     | SO listen             | steady             | hear call                           |
| Eligible VDN call (out of vector processing in listen-only)  | SO listen             | steady             | hear call                           |
| Eligible VDN call (out of vector processing in listen/ talk) | SO listen/talk        | winking            | hear/talk on call                   |
| Press button while observing in vector processing            | SO listen             | steady             | no change to mode                   |
| Press button while not in vector and in listen-only          | SO listen/talk        | winking            | hear/talk on call                   |
| Call being observed becomes ineligible                       | wait state            | flash              | ineligible tone followed by silence |
| Active call disconnects                                      | wait state            | flash              | silence                             |
| Logical agent logs out                                       | denied                | broken flutter     | busy, then silence                  |
| Observer (without button) hangs up                           | deactivates observing | n/a                | n/a                                 |

While observing, the observer should press only the following buttons:

- Call Appearance
- Service Observing
- Position Busy
- Auto-ckt Assure
- Release (ACD)  
(This will end Service Observing)
- Bridged Appearance
- Auxiliary Work

- Queue Status (NQC, OQT, AQC, and AQT)
- System Night Service
- Hold (ignored)

## SECURITY ALERT:

### General security

Use the following COR restrictions to prevent unauthorized observing.

- For the observer, set `Can Be An Observer` on the COR form to **y**.
- For the agent to be observed, set `Can Be Observed` on the COR form to **y**.
- For the observer, grant permissions to all CORs to be observed on the Service Observing Permissions COR table.

### VDN-call security

Use the following COR restrictions for VDN-call observing.

- For the VDN extension to be observed, set `Can Be Observed` on the COR form to **y**.
- For the VDN destination, set `Can Be Observed` on the COR form to **y**.
- Enter the VDN extensions to be observed in the observer's Service Observing Permissions COR table.

### Vector-initiated security

Use the following guidelines for vector-initiated observing.

- Use Call prompting commands in Service Observing vectors to provide passcode protection and limit access to specific destinations or vector-verified, caller-entered digits.
- Use Time of Day/Day of Week checks in Service Observing vectors.
- Create a vector used exclusively for Service Observing.
- If you use route-to commands to observe a VDN extension, ensure the extension has an observable COR.
- If the observer is observing locally, grant calling permission to the observer on the VDN's COR.

In vector-initiated Service Observing, the COR assigned to the VDN used to initiate Service Observing, the COR assigned to the internal caller extension, and the COR assigned to agent to be observed are used to determine if Service Observing will be allowed. If the agent's COR is not observable, observation fails

regardless of the VDN or caller COR. When a call routes through multiple VDNs, the COR of the last VDN is used for calling/observing permissions regardless of VDN Override settings.

If you have administered the optional warning tone, the caller and the observer hear the tone only when the system connects the call to the answering or routed-to destination after vector processing is finished. The periodic tone is heard during the call even if the call is transferred off-switch. Use a warning announcement at the beginning of vector processing to inform the caller of observation since the system cannot give a warning tone until the call is out of vector processing.

## Remote-access security

Use the following guidelines for remote observing.

- Use Barrier Codes and Authorization Codes to limit the use of Remote Access to authorized users. See [“Remote Access” on page 4-509](#) for information about these codes and other Remote Access security measures.
- Use different Authorization Codes for different Service Observing permissions.
- Use Facility Restriction Levels (FRLs) and restrictions such as the Authorization Code COR to restrict Remote Access service observer access to other destinations (for example, stations or trunks).
- Use Call Prompting to create additional access security.

Assign the VDN, Barrier Code, and Authorization Code calling and Service Observing permissions and set Can Be Observer to yes on the associated COR form. The last COR encountered is used to determine observer permissions.

## Considerations

---

### Observability

Although an agent can be a member of multiple splits or skills, an agent can be observed by only one observer at a time. If two agents with different supervisors are observed and one agent calls the other, the originator's supervisor observes the call, and the other supervisor is placed in the wait state.

An attendant can be observed but *cannot* be an observer.

## Ineligibility

A call to an agent extension or VDN is ineligible for observing when the call:

- Is already being observed
- Is being busy-verified
- Has Data Privacy active
- Has Data Restriction active, is conferenced with an extension that has Data Restriction active, or is a VDN call that reached an extension that has Data Restriction active
- Has Privacy — Manual Exclusion active, is conferenced with an extension that has Privacy — Manual Exclusion active, or is a VDN call that reached an extension that has Privacy — Manual Exclusion active
- Is in a conference where adding the observer results in more than 6 parties (see [“Conferenced calls” on page 4-548](#) for more detail on conferences)
- Is a VDN-observed call that reaches an unobservable extension or VDN. (Note that the COR of the hunt group, split, or skill used to distribute the call to the station/agent is not checked. The CORs of stations/agents conferenced with the call are not checked.)

## Trunk calls

If an agent being observed makes an trunk-call, observation starts after the agent finishes dialing. For central office (CO) trunks, dialing is considered complete when answer supervision is returned or when answer supervision timeout occurs.

## Multiple observers

Multiple observers can observe a single VDN simultaneously, but only one observer is observing a given call to the VDN. There is no limit to the number of observers observing a single VDN as long as the total number of observers actively observing VDNs does not exceed 50.

## Conferenced calls

An observer cannot initiate a conference while observing.

If an observed agent conferences a call and the number of conferenced parties is less than 6, the observer is placed in the wait state until the call is connected. Then the observer observes the conference. In addition, the observer is bridged onto any call on which the agent becomes active before the conference is complete. When the conference is complete, the observer is again bridged onto that call.

If an observed agent conferences a call and the number of conferenced parties (including the observer) is 6, the conference is denied.

A call to an observed VDN cannot be monitored if the observer, caller, and other parties bridged onto the call constitutes more than 6 parties.

If a conference is being observed because an observed agent entered the conference, when the agent hangs up, the conference is no longer observed. If a conference is being observed because an observed VDN call entered the conference, observing continues until the call is routed to an unobservable destination.

Conference members are observed during a conference regardless of their COR setting.

If a VDN call being observed is conferenced to an agent call being observed, the VDN observer continues to observe and the agent observer goes into wait state. If two observers (of either VDN or agent calls) are conferenced to a call, the first observer conferenced-in continues to observe and the second observer goes into the wait state. VDN or agent call observers hear the ineligible tone before going into wait state.

The same rules apply when multiple observers monitor transferred calls.

## Transferred calls

Observers cannot initiate a transfer while observing.

If an agent being observed transfers a call, the observer is placed in wait state. The observer is bridged on after the transfer is complete.

A VDN observer continues to monitor the transferred call until it is transferred or routed to a unobservable destination.

## Interactions

---

- ASAI

A call to an observed VDN continues to be observed after it routes to an adjunct. A call can be routed to a Service Observing FAC by the adjunct routing command in the same way that it can be with the route-to command.

- Assist

A VDN observer continues to observe a call during an assist operation. The observer observes the caller on hold and the conference, when the agent conferences the assist call with the VDN call.

- BCMS

BCMS does not report on Service Observing. BCMS reports show normal measured-call and agent activity related to Service Observing calls. When a physical agent (non-EAS) is observed, the BCMS Report By Login ID shows the physical extension along with the login ID.

- Bridged appearances

If an observer observes agent extension 3082, the observer is bridged onto calls only to 3082. If the agent with extension 3082 has a bridged appearance for extension 3282, calls to extension 3282 are not observed. Although extensions 3082 and 3282 have a call appearance on the same terminal, the observer cannot observe both extensions at the same time.

- Busy-verification

An observer cannot observe an agent call that is bridged onto by busy-verification. Also, an agent's call that is being bridged onto by an observer cannot be busy-verified.

- Call Coverage/Call Pickup

An observer cannot observe a call answered by a covering agent or member of a pickup group until the called agent bridges onto the call. The observer continues observing a call to an observed VDN call if the call is routed to a destination that forwards the call (via Call Coverage, Call Forwarding, or Call Pickup).

- Call Park

An observer cannot park a call while observing the call. An observer observing a VDN continues observing after a call is parked.

- Call Waiting

A call cannot wait on a single-line voice terminal that is being observed.

- Call Work Codes/Integrated Directory

The observer does not hear agent dialing with these features because the digits are passed to the switch in S-channel messages.

- CMS

When an observer is bridged onto a VDN call, CMS is notified.

- Converse command

Converse-split extension ports can be observed as physical extensions. A call to an observed VDN continues to be observed if the call is answered by a VRU through the converse command.

- DCS

To observe stations on another node (a DCS station extension), you must set up remote-access service observing. A DCS station can only observe another node using remote service observing. Service observing displays are not supported across DCS.

- Dialed Number Identification Service  
Observing by VDN provides monitoring by DNIS since the VDNs represent the DNIS of the service dialed.
- Direct Agent Calling  
A Direct Agent call to a logical-agent ID is monitored by observing the Logical Agent not by monitoring the physical extension.
- Hold  
Observers cannot place calls on hold while observing.  
If an observed agent places a call on hold, the observer is put in wait state. A VDN observer continues to monitor the caller placed on hold.
- Leave Word Calling  
Parties on an observed call cannot use LWC.
- Look Ahead Interflow  
If an observed VDN call routes to another location via Look Ahead Interflow, the call continues to be observed. The observer hears a warning tone, if administered at the sending switch, when the call arrives at the receiving switch. The observer continues to hear the periodic tone while observing the VDN call.
- Move Agent/Change Skills  
Moves or changes of physical or logical agents being observed occur according to the move or change rules. Observing continues.
- Multiple Call Handling  
While an agent extension or logical ID is observed, only the active call is monitored. If all calls are put on hold, the observer hears silence.
- Music-on-Delay/Music-on-Hold  
If an observer is in listen/talk mode, neither caller nor observer hears music-on-hold. If an observer is in listen-only mode, the caller hears music-on-hold, but the observer does not. A VDN observer hears music provided to the caller.
- Night Service  
A VDN observer continues to observe when a call routes to night service.
- Recorded Announcement  
A VDN observer continues to monitor a call connected to an announcement. A Verify Announcement call placed by an observed physical or logical agent can also be observed.
- Redirection on No Answer  
A VDN observer continues observing a call after it is redirected or rings “in limbo”.

- Trunks without disconnect supervision

Service observing cannot be activated over no-disconnect-supervision trunks. The caller hears denial indication.

- VDN in a Coverage Path

Observers can observe calls that route to a VDN that is being observed or VDN calls that route to another VDN.

- VDN Return Destination

You can create a prompting VDN with a return destination assigned so that, if you activate observing and it fails or the denial indication times out, the prompting VDN allows you to retry activation. This is true only if the denial and disconnection occur after the call leaves vector processing.

If a vector step fails, the system proceeds to the next vector step. Disconnect or busy commands cause calls to be dropped and do not trigger return destination.

When return destination is triggered, the call is monitored through each return destination operation until the caller disconnects.

- Voice-terminal displays

Non-remote observers' voice-terminal displays mirror exactly what is displayed on the observed physical or logical agent's display. For example:

```
a="3035001234 to Sales SO"
```

While observing a VDN, an observer sees displayed the name of the VDN being observed while in vector processing. After the call leaves vector processing, the name of the agent or trunk group that the call is connected to is displayed.

- VuStats

Nonremote observers using 2-line displays can activate VuStats for an agent. An observer must activate VuStats before using Service Observing. The agent's statistics appear on the second line of the observer's display.

- Zip tone

VDN observers do not hear the zip tone that the answering agent hears.



## Single-Digit Dialing and Mixed Station Numbering

---

Single-Digit Dialing and Mixed Station Numbering allows easy guest access to internal hotel/motel services and provides the capability to associate room numbers with guest-room voice terminals.

### How to administer Single-Digit Dialing and Mixed Station Numbering

---

#### Required forms

| Form                              | Field                      | Page                  |
|-----------------------------------|----------------------------|-----------------------|
| Dial Plan Record                  | ■ All                      | <a href="#">5-99</a>  |
| Feature-Related System Parameters | ■ Short Interdigit Timeout | <a href="#">5-123</a> |

### Detailed description

---

You must create a dial plan for hotel/motel services and room numbers. Some suggestions follow.

- Assign a single-digit extension to internal hotel/motel services such as room service. Assign single-digit extensions to individual-voice terminals or to a group of voice terminals (for example, to service the front desk).
- Assign a prefixed extension to guest rooms.

A prefixed extension is made up of a prefix and an extension up to five digits. The prefix identifies the call type. The switch collects dialed digits, removes the prefix digit, and uses the extension for further processing.

- Mixed station numbering extensions can have from one to five digits and can begin with any digit from 0 to 9.

The first digit, in combination with the number of digits dialed, defines the call type. To differentiate between two numbers with the same leading digit but different lengths, the system monitors the interval after a digit is dialed and before the next digit is dialed. If the interval extends past the administered interdigit timeout, the system assumes that dialing is complete and calculates the number of digits dialed up to that point.

## Examples

Table 4-89. Sample Hotel/Motel Dial Plan 1

| First Digit | Length |     |     |      |      |   |
|-------------|--------|-----|-----|------|------|---|
|             | 1      | 2   | 3   | 4    | 5    | 6 |
| 1           |        | DAC |     |      |      |   |
| 2           | EXT    |     |     |      |      |   |
| 3           | EXT    |     |     |      |      |   |
| 4           | EXT    |     |     |      |      |   |
| 5           |        |     | EXT |      |      |   |
| 6           |        |     |     | PEXT |      |   |
| 7           |        |     |     |      | PEXT |   |
| 8           | DAC    |     |     |      |      |   |
| 9           | DAC    |     |     |      |      |   |
| 0           | ATTD   |     |     |      |      |   |
| *           |        | FAC |     |      |      |   |
| #           |        | FAC |     |      |      |   |

Dial plan 1 allows the following dial access:

- Single-digit access to three hotel/motel services (2, 3, and 4)
- Nonprefixed access to as many as 100 hotel/motel staff extensions (500 through 599)
- Ten dial-access codes (DACs) beginning with the digit 1 (10 through 19)
- Toll-call access via DAC 8
- Toll-call access via DAC 9
- Single-digit access to the hotel/motel attendant (0)
- 2-digit feature-access codes (FACs) [\* or # plus another digit]
- Guest room extensions for as many as 100 floors
  - Access to floors 1 through 9 (prefix digit 6 + [100 through 999])
  - Access to floors 10 through 99 (prefix digit 7 + [1000 through 9999])

Table 4-90. Sample Hotel/Motel Dial Plan 2

| First Digit | Length |     |     |   |   |   |
|-------------|--------|-----|-----|---|---|---|
|             | 1      | 2   | 3   | 4 | 5 | 6 |
| 1           | EXT    | EXT | EXT |   |   |   |
| 2           | EXT    | EXT | EXT |   |   |   |
| 3           | EXT    | EXT | EXT |   |   |   |
| 4           | EXT    | EXT | EXT |   |   |   |
| 5           | EXT    | EXT | EXT |   |   |   |
| 6           | EXT    | EXT | EXT |   |   |   |
| 7           | EXT    | EXT | EXT |   |   |   |
| 8           | DAC    |     |     |   |   |   |
| 9           | DAC    |     |     |   |   |   |
| 0           | ATTD   |     |     |   |   |   |
| *           |        | FAC |     |   |   |   |
| #           |        | FAC |     |   |   |   |
|             |        |     |     |   |   |   |

Dial plan 2 allows the following dial access:

- Single-digit access to the hotel/motel attendant (0)
- Single-digit access to seven hotel/motel services (1 through 7)
- Toll-calling access via DAC 8
- Toll-calling access via DAC 9
- 2-digit access to 60 hotel/motel services (10 through 70)
- 2-digit FACs (\* or # plus another digit)
- Guest-room extensions for floors 1 through 7 (100 through 799)

Cancel timeout intervals if the user dials # after dialing all required digits.

### Considerations

- Mixed Station Numbering allows guest room numbers and room extensions to be the same.
- You cannot assign prefixed extensions longer than five digits (including prefix) to intercom lists.

## 4 Basic Features

### *Single-Digit Dialing and Mixed Station Numbering*

Page 4-556

- A trunk access code (TAC) and an extension can share a first digit only if the extension is shorter than the TAC.
- Although extensions with the same first digit can have different lengths, data-channel extensions must have the maximum number of digits to avoid timeout problems for data calls that the switch automatically sets up, for example, via the Call Detail Recording (CDR) link.
- An extension and a FAC can share the same first digit only if the extension is longer as long as they are not used for Automatic Alternate Routing/Automatic Route Selection (AAR/ARS) faxes. These extensions work only within the switch; they do not work as remote uniform dialing plan (UDP) extensions.

## Interactions

- Attendant Display and Voice Terminal Display  
Prefixed extensions display without the prefix. The return call button causes the prefix to dial, even though it does not display.
- Property Management System (PMS)  
Remove prefixes before messages containing the extension are sent to the PMS.  
Five-digit extensions do not exchange with PMS until modifications are made to the PMS interface.
- Uniform Dial Plan  
The following limitations apply to a distributed communications system (DCS) environment:
  - Extensions that differ in length from the UDP do not distribute to other switches.
  - If the first two digits of an extension correspond to the floor number, floors cannot be serviced by more than one switch.

## Station Hunting

---

Station Hunting routes calls made to a busy station down a chain of stations until one is found that is not active.

### How to administer Station Hunting

---

#### Required forms

---

| Form          | Field                 | Page                 |
|---------------|-----------------------|----------------------|
| Coverage Path | ■ Hunt After Coverage | <a href="#">5-94</a> |
| Station       | ■ Hunt-to Station     | <a href="#">6-14</a> |

### Detailed description

---

To use Station Hunting, you create a station hunting chain that governs the order in which a call routes from one station to the next when the called station is busy. Each station in the chain links to only one subsequent station. However, any number of stations may link to one station.

The system updates the calling party's display with "h" when the system begins checking the station-hunting chain. Likewise, the system updates the display of the station that is hunted-to (the station that takes the call) with an "h."

Calls route through the chain as follows.

**Table 4-91. Station Hunting Characteristics**

| Condition   | Response                                 |
|---|--|
| Encounters an idle extension                                      | Rings extension                          |
| Encounters an active extension                                    | Routes to next extension in chain        |
| Encounters an extension with a blank hunt-to station field        | Returns busy tone if no station was idle |
| Encounters any station a second time                              | Returns busy tone                        |
| Has checked 30 stations in the chain, without finding an idle one | Returns busy tone                        |

There is no limit to the number of extensions that can be in a station-hunting chain.

## Station Hunting examples

In this example ([Table 4-92](#)), extension 2 is the called extension. Because extension 2 is busy, the system follows the station-hunting chain to find an idle extension. The system cannot find an idle extension so it returns busy tone to the caller. Note that the chain terminates with extension 5. This means that the system cannot route the call to extension 1 even though it is an idle extension in the chain.

**Table 4-92. Station-Hunting Chain — Example 1**

| Extension | State  | Rings on extension |
|-----------|--------|--------------------|
| 1         | Idle   | 2                  |
| 2         | Busy   | 3                  |
| 3         | Active | 4                  |
| 4         | Active | 5                  |
| 5         | Busy   |                    |

In this example ([Table 4-93](#)), extension 2 is the called extension. Because extension 2 is busy, the system follows the station-hunting chain to find an idle extension. The call is answered at extension 1.

**Table 4-93. Station-Hunting Chain — Example 2**

| Extension | State  | Rings on extension |
|-----------|--------|--------------------|
| 1         | Idle   | 2                  |
| 2         | Busy   | 3                  |
| 3         | Busy   | 4                  |
| 4         | Active | 5                  |
| 5         | Active | 1                  |

In this example ([Table 4-94](#)), extension 2 is the called extension. Because extension 2 is busy, the system follows the station-hunting chain to find an idle extension. The system encounters extension 3 a second time without finding an idle station. The system stops checking the station-hunting chain and returns busy tone to the caller. Notice that both extensions 5 and 2 link to extension 3.

**Table 4-94. Station-Hunting Chain — Example 3**

| Extension | State | Rings on extension |
|-----------|-------|--------------------|
| 1         | Idle  | 2                  |
| 2         | Busy  | 3                  |
| 3         | Busy  | 4                  |
| 4         | Busy  | 5                  |
| 5         | Busy  | 3                  |

### Administration commands

When you remove a station, the system attempts to maintain a station-hunting chain. Consider the following examples:

- Station 1 links to 2 and 2 links to 3. If you remove station 2, the system links 1 to 3.
- Station 1 links to 2. Station 2 does not link to another extension. If you remove station 2, 1 no longer links to another extension.

When you duplicate a station, the extension in the hunt-to station field is not copied into the duplicated station.

When you execute “list usage extension xxxxx,” the system displays all stations that contain the station’s extension as their hunt-to station.

### Interactions

Remember that the system checks the station-hunting chain only for idle and available extensions.

- Adjunct Switch Applications Interface  
 The system attempts Station Hunting when ASAI routes to an extension with a hunt-to station.
- Administration without Hardware  
 You can assign a hunt-to station to a station administered without hardware. It is treated as unavailable and skipped.
- Automatic Call Distribution  
 An agent extension can be part of a station-hunting chain. The system hunts the agent’s chain only when the call is made directly to the agent’s extension. Calls distributed through hunt groups to an ACD agent do not hunt the agent’s station-hunting chain. Calls made to an extension for logical agents do not hunt the agent’s station-hunting chain.

- Automatic Callback

The system does not hunt the chain of the called extension when the call is a callback-return call.

- Bridged Appearance

The system hunts the extension's station-hunting chain if the principal station has no call appearance at which the call can terminate, even though it may have available bridged appearances on other stations.

- Busy Verification

The system does not attempt Station Hunting for busy-verify calls.

- Call Coverage

Call Coverage has precedence over Station Hunting.

Station Hunting is applied to the final coverage point when the following conditions occur:

- The Call Coverage form's `Hunt After Coverage` field is `y`.
- The last coverage point is unavailable (busy or no answer).
- The last coverage point is an station with an assigned hunt-to station.
- No one in the coverage path answered the call.

Coverage — Don't Answer will cover the call after hunt if the call can terminate, but no one answers.

- Call Detail Recording

CDR records the called extension, not the answering extension.

- Call Forwarding

Call Forwarding has precedence over Station Hunting.

If an idle station has Call Forwarding active, the system forwards the call. If a busy station has Call Forwarding active, a call to the station forwards. If the forwarded-to station is busy, the call follows that forwarded-to station's hunting chain.

If the system finds Call Forwarding active at one of the stations in a station-hunting chain, it considers the station busy and bypasses it. The call goes to the next station in the chain.

- Call Park

The system does not attempt Station Hunting on callpark-return calls.

- Call Pickup

Call Pickup functions the same for calls terminating at a point in a station-hunting chain as it does for a regular calls.



- **Call Vectoring**

You cannot assign a Vector Directory Number as a hunt-to station.

If coverage is set to yes, calls to a vector with a route-to step that routes to a busy station follow the hunt-to chain of the busy station. If coverage is set to no, vector processing continues.
- **Call Waiting/Attendant Call Waiting**

Station Hunting has precedence over Call Waiting.

If a called extension has Call Waiting active, and the extension is already busy on a call, the system hunts the station-hunting chain. If the system cannot terminate the call to a member of the chain, then the call waits at the called extension.

If the system finds Call Waiting active at an extension in a station-hunting chain, it considers the extension busy and bypasses it.
- **Class of Restriction**

The system checks the COR of the called extension; it does not check the COR of the hunt-to stations in the chain.
- **Distributed Communications System**

Station Hunting is not a DCS feature. All members of a station-hunting chain must be on the same switch.
- **Extension Number Portability**

You cannot assign a remote ENP extension as a hunt-to station.
- **Hunting/Hunting Group**

You cannot assign a direct departmental calling or Uniform Call Distribution extension as a hunt-to station.
- **Intercom Call**

The system denies Station Hunting for intercom calls to a busy extension.
- **Leave Word Calling**

If a caller initiates Leave Word Calling (LWC), the LWC message is left at the called extension even if the system uses Station Hunting in an attempt to complete the call.
- **Multimedia**

Calls to multimedia endpoints must convert to voice before station hunting.
- **Night Service**

The system denies Station Hunting when a night service call is made to a busy night-console extension.

- **Outgoing Trunk Queueing**  
The system does not attempt Station Hunting for an OTQ callback-return call.
- **Personal Central Office Line**  
The system does not attempt Station Hunting for a PCOL call.
- **Personal Station Access**  
The system considers a station with PSA dissociated as busy and bypasses it in the station-hunting chain.
- **Priority Call**  
The system denies Station Hunting for priority calls.
- **Send All Calls**  
Station Hunting is blocked for an extension with Send All Calls active.
- **Tenant Partitioning**  
The system applies normal tenant restrictions to a call to the called extension. However, the system does not check tenant restrictions on hunt-to stations.
- **Terminal Translation Initialization**  
The system considers a station with TTI separation as busy and bypasses it in the station-hunting chain.
- **Terminating Extension Group**  
You cannot assign a TEG as a hunt-to station.
- **Uniform Dial Plan**  
You cannot assign a remote UDP extension as a hunt-to station.
- **Voice Terminal Restriction**  
The system applies proper intercept treatment to a restricted, called extension. However, the system does not check restrictions on hunt-to stations.

## Station Security Codes

Station Security Codes (SSC) provide security to station users by preventing other users from accessing functions associated with the user's station. Each station user can change their own SSC if they know the station's current settings.

You must create a system-wide SSC change feature access code (FAC) before users can change their SSC. You must also provide users with their individual SSCs. A user cannot change a blank SSC.

### How to administer SSC

#### Required forms

| Form                               | Field                                  | Page                  |
|------------------------------------|--|-----------------------|
| Feature Access Code (FAC)          | ■ Station Security Change              | <a href="#">5-113</a> |
| Security-Related System Parameters | ■ Minimum Station Security Code Length | <a href="#">5-266</a> |
| Station                            | ■ Station Security Code                | <a href="#">6-4</a>   |

### End-user procedures

Table 4-95. How to change an existing station security code

| Information the user enters            | System response  | Explanation  |
|--|------------------|--|
| 1. Station security code (SSC)<br>FAC  | ■ Dial tone      | System is prompting for the extension, #, SSC, and #.  |
|  | ■ Intercept tone | The user entered an FAC not defined in the system or not allowed for this user.  |
| 2. Extension, followed by #, or only # | ■ No response    | The single # indicates that the user is referring to the extension associated with the terminal at which the user is entering the information.<br><br>If the user is using a voice terminal with a display, the # is the last character that the user sees until the command sequence is complete. |

*Continued on next page*

Table 4-95. How to change an existing station security code — *Continued*

| Information the user enters                               | System response     | Explanation   |
|---|---------------------|---|
| 3. SSC for the extension entered in step 2, followed by # | ■ Dial tone         | The system is prompting for the new SSC.  |
|   | ■ Intercept tone    | The extension is not in the numbering plan. Or the combination of the extension entered in step 2 and the SSC entered in step 3 is not valid. |
| 4. New SSC, followed by #                                 | ■ Dial tone         | The system is prompting for the new SSC again.  |
|   | ■ Intercept tone    | The SSC is shorter than the system-wide minimum station security code length or is longer than 8 digits.                                      |
| 5. New SSC again, followed by #                           | ■ Confirmation tone | The request is successful — the code is changed.  |
|   | ■ Intercept tone    | The user did not enter the same SSC in steps 4 and 5.   |
|   | ■ Reorder tone      | The station is being administered.  |

### Interrupting the command sequence and logging invalid attempts

If the user hears intercept tone after step 3, the system logs an invalid attempt via the Security Violation Notification (SVN) feature. This is true even if the user attempts to interrupt the change sequence with an asterisk.

If the user stops the change sequence by hanging up or pressing the disconnect or recall button before hearing intercept tone in step 3, the system does not log an invalid attempt.

If a user wishes to interrupt the change sequence after the FAC has been entered and before the final #, the user can enter \* to begin again. The system responds with dial tone.

If the user enters \* before the second # in step 3, the user must begin the change sequence at the point of entering the user's extension in step 2. (The user should not enter the FAC again.)

If the user enters \* in steps 4 or 5, the user must begin the change sequence at the point of entering the new SSC in step 4.

If the user hears intercept tone in any step, the command sequence has been invalidated for some reason and they must restart the process at step 1.

## **Interactions**

---

A user needs an SSC to use the following system capabilities:

- Demand printing
- Extended User Administration of Redirected Calls
- Leave Word Calling
- Personal Station Access
- Voice Message Retrieval

## Temporary Bridged Appearance

---

Temporary Bridged Appearance allows multiappearance voice terminal users in a terminating extension group (TEG) or personal central office line (PCOL) group to bridge onto an existing group call. If a call has been answered using the Call Pickup feature, the originally called party can bridge onto the call. This feature also allows a called party to bridge onto a call that redirects to coverage before the called party can answer it.

### How to administer Temporary Bridged Appearance

---

#### Required forms

---

| Form                              | Field                             | Page                  |
|-----------------------------------|-----------------------------------|-----------------------|
| Feature-Related System Parameters | ■ Keep Held SBA at Coverage Point | <a href="#">5-123</a> |

---

#### Detailed description

---

An incoming call to a TEG or PCOL group is not a call to an individual, although one particular member of the group can be the most qualified person to handle the given call. If this individual did not answer the call originally, this individual can bridge onto the call; the call does not have to be transferred.

A call to an individual can be answered by a call pickup group member. If the called party returns while the call is still connected, the called party bridges onto the call and the answering party hangs up.

Call Coverage provides redirection of calls to alternate answering positions (covering users). A temporary bridged appearance is maintained at the called voice terminal.

The called party can answer the call at any time, even if it is already answered by a covering user. If the called party does not bridge onto the call, the covering user can use the Consult function of Call Coverage to determine if the called party wants to accept the call. The Consult function uses the temporary bridged appearance maintained on the call. When the consult call is finished, the temporary bridged appearance is removed.

Stations that normally have a temporary bridged appearance with their coverage point do not have a temporary bridged appearance if the coverage point is AUDIX.

## Considerations

---

- Temporary Bridged Appearance allows the desired party to bridge onto a call without manually transferring the call, providing convenience of operation and saving time.
- Temporary Bridged Appearance does not provide any call originating capability or the capability to answer another party's calls. These capabilities are provided by the Bridged Call Appearance feature.
- If two parties are bridged together on an active call with a third party, and if the Conference Tone feature is enabled, conference tone is heard.
- The Bridged Call Appearance feature enhances Temporary Bridged Appearance by allowing more than one call to an extension to be bridged and by allowing calls to be originated from bridged appearances.

## Interactions

---

- Call Coverage

Calls redirected to Call Coverage maintain a temporary bridged appearance on the called voice terminal if a call appearance is available to handle the call. The called party can bridge onto the call at any time. The system can be administered to allow a temporary bridged appearance of the call to either remain at or be removed from the covering voice terminal after the principal bridges onto the call. If two parties are bridged together on an active call with a third party, and the bridging tone is administered to yes, all three parties hear the bridging tone.
- Consult

Consult calls use the temporary bridged appearance maintained on the call. At the conclusion of a consult call, the bridged appearance is no longer maintained. If the principal chooses not to talk with the calling party, the principal cannot bridge onto the call later.
- Conference and Transfer

If a call has, or has had, a temporary bridged appearance; is conferenced or transferred; and redirects to coverage again; a temporary bridged appearance is not maintained at the conferenced-to or transferred-to extension.
- Privacy — Manual Exclusion

When Privacy — Manual Exclusion is activated, other users are prevented from bridging onto a call. A user who attempts to bridge onto a call when this feature is active is dropped.

## Tenant Partitioning

---

Tenant Partitioning provides telecommunications services to multiple independent groups of users through a single DEFINITY ECS. Most commonly, Tenant Partitioning provides these services from a single provider to multiple tenants of an office complex. This eliminates the need for each tenant to purchase services separately, while still giving each tenant the appearance of a dedicated DEFINITY ECS. You can also use this feature to provide group services, such as departmental attendants, on a single-customer DEFINITY ECS. Tenant Partitioning also allows you to assign a unique music source for each tenant partition for callers who are put on hold.

### NOTE:

If you use equipment that rebroadcasts music or other copyrighted materials, you may be required to obtain a copyright license from, or pay fees to, a third party such as the American Society of Composers, Artists, and Producers (ASCAP) or Broadcast Music Incorporated (BMI). You can purchase a Magic-on-Hold<sup>®</sup> system from AT&T, which does not require such a license.

## How to administer Tenant Partitioning

---

### Required forms

| Form                        | Field                  | Page                  |
|-----------------------------|------------------------|-----------------------|
| Tenant                      | ■ All                  | <a href="#">5-292</a> |
| Attendant Console           | ■ Group Number<br>■ TN | <a href="#">5-35</a>  |
| Access Endpoint             | ■ TN                   | <a href="#">7-72</a>  |
| Agent LoginID               | ■ TN                   | <a href="#">9-193</a> |
| Announcements/Audio Sources | ■ TN                   | <a href="#">5-26</a>  |
| Console-Parameters          | ■ TN                   | <a href="#">5-86</a>  |
| Data Modules                | ■ TN                   | <a href="#">6-230</a> |
| Hunt Groups                 | ■ TN                   | <a href="#">5-158</a> |
| Loudspeaker Paging          | ■ TN (1–9, All)        | <a href="#">5-209</a> |
| Remote Access               | ■ TN                   | <a href="#">5-258</a> |
| Station                     | ■ TN                   | <a href="#">6-28</a>  |

*Continued on next page*



**Required forms — Continued**

| Form                        | Field | Page                  |
|-----------------------------|-------|-----------------------|
| Terminating Extension Group | ■ TN  | <a href="#">5-295</a> |
| Trunk Groups                | ■ TN  | <a href="#">7-115</a> |
| Vector Directory Number     | ■ TN  | <a href="#">9-214</a> |

**How to administer Multiple Music-on-Hold**

**Required forms**

| Form          | Field          | Page                  |
|---------------|----------------|-----------------------|
| Music Sources | ■ All          | <a href="#">5-243</a> |
| Tenant        | ■ Music source | <a href="#">5-292</a> |

**Detailed description of Tenant Partitioning**

Tenants are defined and assigned by you, the system administrator. You must have the same authorization as that required for COR administration.

Because some features are not partitioned, you must take care to administer these features to prevent inter-tenant access. See [“Interactions” on page 4-574](#) for a list of these features.

You must ensure that:

- All tenants can call and be called by partition 1. This is the system default. If you change this default some call types fail. For example, *dial 0 fails*, as do SVN calls, ACA calls, etc.
- All stations in a call-pickup group are under control of the same tenant
- All stations with bridged appearances are under control of the same tenant
- Stations in different departments (for the purposes of attendant services) can call each other

See *DEFINITY Enterprise Communications Server Release 6 System Description Pocket Reference* to determine the number of tenants that your system allows.

You must assign a tenant partition number to each object (endpoint, virtual endpoint, or other entity) that has an assigned COR. The exceptions are authorization codes and fixed-assignment virtual endpoints.

You administer Tenant Partitioning via the Tenant Partitioning form; you need to administer one form for each tenant partition. Begin the initial administration of the Tenant Partitioning feature by completing the tenant partitioning form. Keep in mind that you must specify an attendant group for each tenant that you define, even if there are no consoles assigned to the attendant group. You must also assign an attendant console to a tenant partition and you must assign a group number to the Attendant Console form.

## Tenant Partitioning capabilities

Tenant Partitioning can provide the following services to tenants: telephone equipment, building wiring, public and private network access, and attendant services. In addition, the feature can provide a full range of DEFINITY ECS capabilities to even the smallest tenant office, including Call Coverage, Remote Access, Night Service Routing, and others. Tenants can also purchase DEFINITY ECS adjuncts available on the switch, such as CMS activity reporting.

Tenant Partitioning provides advantages to both the telecommunications service provider and individual tenants:

- Shared resources offer enhanced services at lower cost to the tenant, with increased profit for the service provider.
- The tenant has the appearance of a dedicated DEFINITY ECS without the expense.
- All tenants can have attendant services.
- A trained, full-time system administrator can install, administer, and maintain the switch.

With proper administration, tenant resources, including trunking facilities, and all other switch endpoints can be protected from access by other tenants.

## Partitioning tenants

The default for Tenant Partitioning is one universal tenant for the system. This tenant, partition 1, is usually reserved for the service provider. By default it has access to all facilities and any other tenant can access it.

The service provider creates additional partitions based on tenant requirements. When deciding which tenant partitions to create, remember:

- You can assign each switch endpoint to one and only one tenant partition. And, you must pass each switch endpoint to a partition. For example, you must assign each voice terminal, attendant console, trunk, and virtual endpoint, such as an LDN or VDN, to a tenant partition.
- Most tenant partitions are discrete, separate units. By default, the system prevents all tenants, except partition 1, from accessing stations or trunking facilities belonging to other tenants. However, you can change this default. You can give explicit permission for one tenant to access another. For example, you can allow tenant 6 to call tenants 9 and 16 only.

 **NOTE:**

If a tenant has permission to call another tenant, it has access to every endpoint belonging to that tenant. For example, if tenant 6 has permission to call tenant 9, tenant 6 can also use any trunking facilities present in tenant partition 9.

- Even if two extensions are blocked from calling each other by Tenant Partitioning restrictions, either extension can still reach the other by dialing the extension's Direct Inward Dialing (DID) number via the public network.
- If any facilities are to be shared among tenants who do not want complete access to each other's facilities, you must group the shared facilities in a separate partition. For example, if two tenants share a trunk, but do not have direct access to each other's voice terminals, that trunk will need to be placed in its own partition so that both tenants can access it.

It is also important to consider the following constraints and requirements of access control, attendant services, music sources on hold, and network route selection when you establish or assign partitions.

### Access control

Features such as call coverage are limited by tenant-to-tenant access restrictions. For example, suppose tenant 1 includes a voice terminal from tenant 2 in its coverage path. If tenant 3 has permission to call tenant 1 but not tenant 2, a call from tenant 3 to tenant 1 skips the tenant 2 coverage point.

You may also want to set up tenants with special access privileges. For example, you might give a restaurant in an office complex permission to be called by any other tenant. Likewise, permission to call or be called by other tenants is helpful for building security or DEFINITY ECS administration or troubleshooting.

You can also assign all CO trunks to one tenant partition that can then be accessed by all other tenants.

### Attendant services

Tenant Partitioning allows you to provide personalized attendant services to each tenant.

The system provides one principal and one night or day/night attendant per attendant group. You assign each tenant an attendant group for service. Each attendant group has a separate queue. Queue warning lamps remain dark when Tenant Partitioning is active. However, information displayed when someone presses a queue-status button reflects the status of the attendant-group queue. The total number of calls queued for all tenants cannot exceed the system limit.

Attendant groups may serve more than one tenant. In this case, the attendant group cannot extend a call from one tenant via facilities belonging to another tenant, unless the former tenant has permission to access the other's facilities.

Each tenant may have a designated night-service station. The system directs calls to an attendant group in night service to the night-service station of the appropriate tenant (when a night attendant is not available). When someone places an attendant group into night service, all trunk groups and hunt groups that belong to tenants served by that attendant group go into night service. In this case, the system routes incoming calls to the night-service destination of the appropriate tenant. Each tenant can have its own listed directory number (LDN) night destination, trunk answer on any station (TAAS) port, or night attendant.

An attendant can specify that access to a trunk group is under attendant control if the trunk group is assigned to a tenant served by that attendant's group. The system directs any valid user attempt to access the trunk group to the attendant group serving the tenant.

### Network route selection

You can place trunk groups belonging to different tenants in the same route pattern. Calls routing to that pattern select the first trunk group in the pattern with access permission by the calling tenant (subject to normal constraints).

## Tenant partitioning examples

The following is a simple example of how you might administer Tenant Partitioning in an office complex.

You assign tenant partition 1, the universal tenant, as the service provider. All other tenants can call and be called by the service provider.

You assign tenant partitions 2–15 to individual businesses in the complex. You maintain the system-default restrictions for these tenants. That is, tenants cannot access voice terminals, trunking facilities, or other switch endpoints belonging to other tenants.

You assign tenant partition 16 to the restaurant in the building complex. You give all tenants permission to call this tenant. However, to prevent the restaurant from accessing trunks and other facilities belonging to tenants, you do not permit the restaurant to call any other tenants.

You assign tenant partition 17 to all CO trunk groups. You give all tenants permission to call this tenant.

You assign tenant partition 18 to a trunk group that tenants 3 and 7 want to share. You give Tenants 3 and 7 access to this partition; you deny all other tenants access. To prevent toll fraud, you do not allow tenant 18 to call itself.

The ARS route pattern can be the same for all tenants. In this example, the trunk for tenant partition 18 (the private trunk shared by tenants 3 and 7) is first in the route pattern. Tenant partition 17 is second. Tenants 3 and 7 route first to partition 18 and then as a second choice to partition 17. You deny all other tenants access to partition 18 and so the system routes them directly to partition 17.

All facilities that are not shared, including trunk groups, VDNs, voice terminals, attendant consoles, and other endpoints, are assigned to the tenant partition that they serve.

[Table 4-96](#) summarizes the calling permissions for the different partitions. Yes indicates that the partitions have permission to call and be called by each other; no indicates that partitions cannot call or be called by each other.

**Table 4-96. Calling permissions for partitions**

| Calling tenant partition number | Called tenant partition number |   |   |     |     |     |
|---------------------------------|--------------------------------|---|---|-----|-----|-----|
|                                 | 1                              | 2, 4—6, 8—15                                      | 3,7   | 16  | 17  | 18  |
| 1                               | yes                            | yes   | yes   | yes | yes | yes |
| 2, 4-6, 8-15                    | yes                            | Each partition can call itself but not the others | no  | yes | yes | no  |
| 3,7                             | yes                            | no  | Each partition can call itself but not the others | yes | yes | yes |
| 16                              | yes                            | no  | no  | yes | yes | no  |
| 17                              | yes                            | yes   | yes   | yes | yes | no  |
| 18                              | yes                            | no  | yes   | no  | no  | no  |

### Detailed description of Multiple Music-on-Hold

Tenant Partitioning allows you to assign each tenant a music source, unique to each tenant partition, to be heard when a call is placed on hold. This capability allows you to tailor the music or messages for the business needs of each tenant partition. However, keep in mind that the caller on hold hears the music source assigned to the partition at which the call initially terminates. For example, if calls coming into the DEFINITY ECS route first to an INTUITY automated attendant that then routes the call to the appropriate tenant partition, the caller on hold hears the music source of the INTUITY automated attendant, not the tenant partition to which it is routed. Likewise, if a caller in tenant partition 2 makes an out-going call using tenant partition 1's trunk groups, the caller will hear the music source assigned to tenant partition 1.

The maximum number of music sources allowed is the same as the maximum number of tenant partitions allowed; each music source can be used by one or more tenant partitions.

You can assign one of the following music-on-hold types to each tenant partition.

**Table 4-97. Music-on-Hold Types**

---

| Type  | System Response for a caller placed on hold  |
|-------|--|
| none  | silence  |
| tone  | system-wide administered tone  |
| music | the music associated with the administered port. The number of possible music sources equals the number of possible tenant partitions. Each partition can have its own music source. |

---

## Interactions

---

Tenant-partition identification is not passed between switches. A network of DEFINITY ECS systems does not enforce Tenant Partitioning restrictions without special administration. For example, Tenant Partitioning on a network of DEFINITY ECS systems does not enforce tenant-specific tie trunks.

Administration of the following features requires special care to avoid undesired intertenant access.

- Bridging
- Call Pickup
- Controlled Restriction
- Facility Busy Indication
- Facility Test Calls
- Integrated Directory
- Inter-PBX Attendant Calls
- Main/Satellite/Tributary
- Malicious Call Trace
- Personal CO line
- Private Networking (AAR)
- Uniform Dial Plan

The function of any feature that specifies a tenant partition is affected by tenant-to-tenant restrictions, as follows.

- AAR/ARS

Do not confuse tenant partitions with Time-of-Day Plan Numbers and Partition Groups in AAR/ARS. You can still use Time-of-Day Plan Numbers and Partition Groups can still be used to select one of eight route patterns for AAR/ARS routing when Tenant Partitioning is in effect.

- Attendant and Attendant Group Features

Tenant Partitioning creates multiple attendant groups. Attendant operations such as direct-station or trunk-group select (DCS/DTGS) are subject to tenant-to-tenant restrictions, both at selection time and at split time.

All calls put on hold by an attendant from the attendant group hear the music source from the attendant group.

- Attendant Control of Trunk-Group Access

An attendant group controls access only to trunk groups that belong to tenants that are served by that attendant group.

- AUDIX, DEFINITY AUDIX, and AUDIX Voice Power

AUDIX voice and data ports are subject to the same tenant-to-tenant restrictions as any other endpoint.

AUDIX can restrict one group of subscribers from sending voice mail to another group. The tenant-partitioning provider can create up to 10 different communities within each AUDIX that either have or do not have permission to send voice messages across community boundaries.

- Automatic Wakeup

Wakeup music will be the music source assigned to the wakeup station's tenant partition.

- Bridged Call Appearance

All stations with bridged call appearances should be administered to be under control of the same tenant.

- Call Coverage

Tenant-to-Tenant access restrictions apply to coverage paths. If a tenant cannot access a particular tenant, it cannot access that tenant as part of another tenant's coverage point.

When an attendant is specified as part of a coverage path, the attendant group of the called tenant, not the calling tenant, is accessed.

When a call goes to coverage, is answered, and is put on hold, the music on hold is the music source assigned to the tenant partition of the terminal that was originally called.

- Call Detail Record (CDR)

CDR does not report the tenant partition number of the extension or trunk group used. You must infer the tenant partition number from the extension or trunk-group number.
- Call Pickup

Administer all stations in a call-pickup group to be under control of the same tenant. The system supports Call Pickup only if the caller and the called party can both call the pickup user. The caller and the called party do not need to be in the same pickup group.
- Call Vectoring/VDN

A caller routed to a new destination by a vector step hears the music assigned to the new destination.
- CMS

You can administer CMS to provide CMS reports to each tenant. You can restrict each CMS login to control, on a permission basis, only those entities that are assigned to a particular tenant. Outputs to separate printers allow any tenant to print their own CMS reports. The tenant-partitioning provider must administer CMS to provide this separation of tenant permissions.
- Dial Access to Attendant

When a tenant dials an attendant, it accesses its own assigned attendant group.
- Emergency Access to the Attendant

When a tenant dials emergency access, it accesses its own assigned attendant group.
- Intercept Treatment

When access to the attendant is designated as intercept treatment, the caller accesses their assigned attendant group.
- Malicious Call Trace

By default, Malicious Call Trace extensions are assigned to tenant partition 1. Therefore, if Malicious Call Trace is enabled, any voice terminal with permission to call tenant partition 1 can use it.
- Multiple Listed Directory Numbers

Each Listed Directory Number is assigned to a tenant partition.
- Multiple Audio/Music Sources for Vector Delay

When music is administered on the wait-time vector step, the music played is the music source of the VDN's tenant number.



## 4 Basic Features

### Tenant Partitioning

Page 4-577

- Music-on-Hold Access

When `Tenant Partitioning` is enabled, you can assign a unique source for music to each tenant. If `Tenant Partitioning` on the System-Parameters Customer-Options form is set to **y**, you must use the Music Sources form to administer music-on-hold.

- Night Service

Each tenant can have its own Listed Directory Number (LDN) night destination, Trunk Answer on Any Station (TAAS) port, or night attendant.

- PC Interfaces

You must assign each PC interface to a tenant partition.

- PC/PBX Connections

You must assign each PC/PBX Connection to a tenant partition.

- PC/ISDN

You must assign each PC/ISDN to a tenant partition.

- Remote Access

You must assign each Remote Access barrier code to a tenant.

- Traffic Studies

Traffic studies do not report the tenant partition number of the extension or trunk group used. You must infer the tenant partition number must be inferred from the extension or trunk-group number.

- Uniform Dial Plan

If a Uniform Dial Plan is in place between switches, tenant partition identification is not passed between the switches, and so tenant-partition restrictions are not enforced between the switches without special administration.



**NOTE:**

Tenant Partitioning restrictions do not override COR restrictions. COR restrictions are independent of tenant partitions.

## Terminal Self Administration

---

Terminal Self-Administration (TSA) allows users to administer some of their own feature buttons from their own terminal. Users are prompted, via the terminal's display, to choose features to assign to buttons on their voice terminals. TSA can be administered on 6400-series display voice terminals or display voice terminals that have a firmware upgrade to support the Admin mode, provide at least four softkeys, and have 2 X 24 displays.

### How to administer TSA

---

Before administering TSA, make sure that:

- The voice terminal is plugged into its jack.
- The voice terminal is defined with an extension and an assigned port location.

### To administer the Admin button

On the 6400 Station form, administer the Admin button as "admin." You can assign this button to a feature button or a softkey.

### To administer whether a security code is needed to enter TSA

On page 2 of the Change System-Parameters Security form:

- Type **y** in the `Security Code for Terminal Self-Administration Required?` field if the user will have to enter a security code after they press the Admin button.
- Type **n** if the user will not have to enter a security code.



**NOTE:**

If you type **y** in this field, assign the user a security code on the first page of the 6400 Station form.

### To administer user-defined language for displayed messages

If the displayed language is set to "user-defined" for any user in the system, change the translation for each "user-defined" message to the language that the user requests.

1. Use the **change display-messages self-administration** command to access the 3-page Change Display-Messages Self-Administration form.
2. Change the translation for each "user-defined" message to the language that the user requests.

## Detailed description

---

Before a user can enter the TSA Admin mode, their terminal must be completely idle. If the terminal is not idle, the user receives a beep tone and the button press is ignored.

After a user presses the Admin button and enters a security code (if necessary), they are prompted, via the terminal's display, to choose features to administer to buttons on their voice terminal. The user can add, replace, or delete any of the following feature-button types from their voice terminal. Also, the user can change some, but not all, auxiliary data associated with these buttons.

- CDR Account Code
- Automatic Dial
- Blank
- Call Forwarding
- Call Park
- Call Pickup
- Directed Call Pickup
- Group Page
- Send All Calls
- Activate Whisper Page
- Answerback for Whisper Page
- Whisper Page Off

End-user button changes are recorded in the system history log and security code attempts and successes are recorded in the Security Violations Notification (SVN) log so that remote services can know what translations are changed.

See *6400-Series Single-Line Telephone User's Guide (555-230-738)* and *6400-Series Multi-Line Telephone User's Guide (555-230-739)* for more information about user interactions.

## Considerations

---

### Security

To prevent people from either accidentally or maliciously changing other people's phone administration, TSA provides a system-wide option of requiring a security code before the user can enter the Admin mode to administer their buttons. The security code used by this feature is the same as the Personal Station Access (PSA) code, which is also used by the telecommuting feature, Call Coverage — Off-Net.

If this administrable option is turned on, after pressing the Admin button on 6400 terminals, the user is prompted for their PSA security code. They must enter it, followed by either pressing the pound sign (#) button or the Done softkey. If the user enters the wrong security code, they see an appropriate error message on the display. All of the security violation thresholds, reports, and measurements that currently apply to the entry of PSA security codes during PSA feature activation also apply to the entry of PSA security codes during TSA.

To prevent voice terminals from accidentally being left in the Admin mode, the switch returns a voice terminal from the Admin mode to the Normal mode five minutes after the voice terminal enters the Admin mode or successfully programs a button, whichever is later.

## Interactions

---

### NOTE:

When a terminal is in the Admin mode, the terminal cannot accept any calls — the terminal is treated as if it were busy. Also, a user cannot make calls while in the Admin mode.

Any button state a voice terminal is in when the voice terminal enters the Admin mode stays active while the voice terminal is in the Admin mode.

- ACD Agents

ACD agents who wish access to the Admin mode of TSA must be logged off before pressing the Admin button. If they are not logged off when they attempt to enter the Admin mode, they receive a denial (single-beep) tone.

- Administered Connections

A voice terminal that is an endpoint of an administered connection is always active on a call, therefore TSA cannot be used.

- Attendant Direct Extension Selection with Busy Lamp

The attendant console's voice terminal status module shows voice terminals in the Admin mode as busy.

- Attendant Intrusion

Attendant intrusion is not possible on a voice terminal that is in the Admin mode.

- Automatic Callback

Automatic Callback stays active if a switch-generated automatic callback call comes in while a voice terminal is in the Admin mode. The call-back call is redirected to coverage.

- Automatic Wakeup

Automatic Wakeup treats a voice terminal in the Admin mode as busy.

## 4 Basic Features

### Terminal Self Administration

Page 4-581

- **Busy Verification**

Busy Verification shows a voice terminal in the Admin mode as busy.
- **Call Coverage**

A Call Coverage path is followed when the terminal is in the Admin mode because the switch treats the phone as being busy.
- **Call Forwarding**

Call Forwarding can be active and works correctly in the Admin mode. An active Call Forwarding button cannot be removed when the terminal is in the Admin mode.
- **Call Forwarding — Busy/Don't Answer**

A Call Forwarding — Busy/Don't Answer can be active and works correctly in the Admin mode.
- **Call Park**

Call Park can be active and works correctly in the Admin mode.

If a parked call times out while the parking extension is in the Admin mode, the call is treated the same as if all appearances on the parking set had been busy. The call routes to the attendant, a night service extension, or the coverage path; or is dropped.
- **CAS Backup**

CAS Backup can be active and works correctly in the Admin mode.
- **Class of Service**

All classes of service can access this feature.
- **Facility Busy Indication**

A facility busy indication button for a voice terminal in the Admin mode appears as busy.
- **Headset**

Since the terminal must be on-hook to go into the Admin mode, the Headset On/Off button must be in the OFF position.
- **Intrusion and Rering**

This feature blocks Russian and Chinese intrusion. A voice terminal cannot enter the Admin mode while it has a call appearance on hold awaiting Russian or Spanish rering because it is not considered completely idle.
- **Personal Station Access (PSA)**

A voice terminal that is in the Admin mode of TSA cannot be remotely unmerged by the PSA feature.

**4 Basic Features**

*Terminal Self Administration*

*Page 4-582*

- Ringing — Abbreviated and Delayed

If this feature is active, a call can be silently ringing at a voice terminal and the user may not realize it. This prevents the user from entering the Admin mode of TSA.

- Send All Calls (SAC)

Send All Calls can be active for a terminal in the Admin mode. The SAC state is unaffected by the terminal being in the Admin mode.

## Terminal Translation Initialization

Terminal Translation Initialization (TTI) allows you to merge an Administered Without Hardware (AWOH) station to a valid port by dialing a system-wide TTI security code and the extension from a terminal connected to that port. TTI also allows you to separate a station from its port by dialing a similar separate digit sequence. This action causes the station to be administered without hardware.

### How to administer TTI

#### Required forms

| Form                              | Field   | Page                  |
|-----------------------------------|---|-----------------------|
| Feature-Related System Parameters | ■ TTI Enabled   | <a href="#">5-123</a> |
|                                   | ■ TTI State   |                       |
|                                   | ■ TTI Security Code                                   |                       |
| Feature Access Code (FAC)         | ■ Terminal Translation Initialization Merge Code      | <a href="#">5-113</a> |
|                                   | ■ Terminal Translation Initialization Separation Code |                       |
| Station                           | ■ All   | <a href="#">6-28</a>  |
| Attendant Console                 | ■ All   | <a href="#">5-35</a>  |
| Data Module                       | ■ All   | <a href="#">6-230</a> |

### Detailed description

If TTI is active, and you want to disassociate a station, set `Port` to **X** (Station, Attendant, and Data Module forms). If TTI is not active, then a port that is separated from its station or data module becomes an unadministered port.

When TTI is enabled for voice, all voice ports (except BRI ports) become TTI ports or ports from which a TTI merge sequence can occur.

TTI can be used for implementing station and data module moves from office to office. That is, the user separates the station from its port with TTI, unplugs the station from the jack, plugs the station in a jack in a different office, and merges the station to its new port with TTI. To activate a station, dial the FAC, TTI Security Code, and the extension at the new location.

## TTI merge from a voice TTI port

Before you can merge a voice station, you must set **TTI State** to **voice** on the Feature-Related System-Parameters form. You also must set the station to match the port type of the TTI port making the merge request. For example, a digital terminal type can merge only to a port on a digital board.

### **CAUTION:**

*You can destroy your hardware if you attempt to connect an analog station to a digital port.*

To merge a station and a terminal with TTI, complete the following steps from the terminal to which the station is to be merged:

1. Dial the TTI merge FAC.
  - If the code is correct, you receive dial tone.
  - If the code is not correct, you receive intercept tone.
2. Dial the TTI security code from the terminal to which the station is to be merged.
  - If the code is correct, you receive dial tone.
  - If the code is not correct, you receive intercept tone.
3. Dial the extension of the station to be merged.
  - If the extension is valid, you receive confirmation tone, which may be followed by dial tone. (It is possible to receive intercept tone immediately following the confirmation tone. If this happens, you need to attempt the merge again.)
  - If the extension is valid, but the extension is being administered, you receive reorder tone. Try the merge again later.
  - If the extension is invalid, you receive intercept tone.
  - If the system is busy and cannot complete the merge, you receive reorder tone. Try the merge again later.
  - If the station has a download status of pending, you receive reorder tone. You need to change the download status to complete to successfully complete the TTI merge.



## TTI separation from a voice station

To complete a TTI separation, complete the following steps from the terminal that needs to be separated:

1. Dial the TTI separate FAC.
2. Dial the TTI security code.
  - If the code is correct, you receive dial tone.
  - If the code is not correct, you receive intercept tone.
3. Dial the extension of the station to be separated.
  - If you have dialed the extension of the station currently merged with this terminal, you receive confirmation tone.
  - If you have dialed the extension of the station currently merged with this terminal, but the extension is being administered, you receive reorder tone. Try the separation again later.
  - If you have not dialed the extension of the station currently merged with this terminal, you receive intercept tone.
  - If the system is busy and cannot complete the separation, you receive reorder tone. Try the separation again later.

## Terminal separation from other terminals

The previous examples are for voice terminals. TTI also supports attendants, data modules, voice/data terminals, and ISDN-BRI terminals.

### Attendants

In order for attendants to use TTI, you must assign an extension to the attendant console. TTI port translations are the same for digital voice terminals and attendant consoles. To merge a digital TTI voice port and an attendant, you must first administer the attendant as AWOH. Then a digital voice station must be plugged into the jack assigned to the attendant console, and the TTI merge digit sequence must be entered on the digital voice station. Once the TTI merge has been completed for the attendant console, the digital station must be unplugged and the attendant plugged into the jack.

An attendant console can be separated from its port only through administration. A TTI separate request from an attendant console gives the user intercept treatment.

### Data modules

Data modules have different tones and digit sequences.

In the merge and separate control flow, different tones are given to the voice terminal user to give the current status of the TTI operation. Instead of audible tones, status messages are displayed on a terminal connected to a data module

## 4 Basic Features

### Terminal Translation Initialization

Page 4-586

when activating the TTI sequence through keyboard dialing. If `TTI State` is set to **data**, you see the data display messages. If `TTI State` is set to **voice**, you hear the tones.

For a stand alone data module, the TTI merge/separate digit sequence is entered in one line at a dial prompt:

- DIAL: <TTI feature access code><TTI security code><AWOH ext>

Separate prompts are not given for the TTI security code and extension.

### Voice/data terminals

A station with a data terminal (DTDM) is treated as a voice terminal in the TTI merge and separation sequence. The DTDM is merged with and separated from its hardware translation at the same time the station is merged or separated. The TTI merge and separate sequence can only be initiated through the voice station for DTDMs; it cannot be initiated through the data port.

### ISDN BRI terminals

The TTI separation sequence for Automatic-TEI SPID-initializing BRI terminals is identical to the sequence used for voice terminals. However, the merge sequence is different.

- Separation sequence
  1. Feature Access Code
  2. Security Code
  3. Extension
- Merge sequence
  1. Connect the station to any port to get power.
  2. Program the SPID to the extension with which it will be merged.
  3. Unplug the station (this is necessary even if the station is connected to its intended port).
  4. Connect the station to its intended port (this port should indicate Equipment Type: TTI Port).
  5. Receive dial tone.
    - If there is dial tone, the merge is complete.
    - If there is no dial tone, the terminal's SPID is not an available extension.

You can dial the TTI merge sequence for BRI sets only if a user separates a BRI extension from its set and then wants to undo the process by reassociating the set to the same extension. Note that you cannot use the SAT to put an X in the port field of a BRI set that is still connected to the switch. You must use the TTI separation sequence from the set.

## Analog Queue Warning Ports and External Alert Ports

The analog queue warning port (used for hunt groups) and the external alert port may be AWOH. These extensions can be merged to an analog port via TTI. The merge must be done by an analog set, and then the analog set is unplugged from the port. These extensions cannot be separated from their port location with the TTI feature. A TTI separate request from one of these ports gives you intercept treatment.

### Security measures

---



#### SECURITY ALERT:

*If you do not manage this feature carefully, its unauthorized use may cause you security problems. For example, someone who knows the TTI security code could disrupt normal business functions by separating voice or data terminals. You can help protect against this action by frequently changing the TTI security code. You can further enhance system security by removing the FAC from the system when it does not need to be used (for example, there are no moves going on at present). Consult the BCS Systems Security Handbook for additional steps to secure your system and find out about obtaining information regularly about security developments.*

### Considerations

---

- The `TTI Ports` field on the System Capacity form shows the number of TTI ports used in a switch. This field shows only the number of TTI ports being administered. This is a required field. If a TTI exceeds the maximum number of ports, the port is not administered and cannot be added. In that case, a station cannot be added.

BRI endpoints are only counted as one TTI port. For example, for every two BRI endpoints, one TTI port is counted. As such, you can have two stations assigned to one port. If either endpoint is administered, the TTI port count is decremented by 1. You can verify this by using the **list configuration station** command.

- The total number of translated voice terminals and Voice TTI ports in a system is limited to the maximum number of administered stations supported in the system. The total number of translated data terminals and Data TTI ports in a system is limited to the maximum number of administered data modules allowed in the system.
- Set `TTI State` to **voice** and then set `TTI State` to **data**. When you use this order, voice and then data, you reduce the chance of a user trying to use TTI on a data-only terminal that does not have TTI port translation. This can happen when the number of voice terminals allowed by the system is twice the number of data terminals. For example, if the system

## 4 Basic Features

### Terminal Translation Initialization

Page 4-588

limit for voice terminals is 15,000 and 7,500 for data, then when TTI was turned on for data first, only the first 7,500 unadministered ports would get TTI port translations.

- When TTI is activated for the system, the following actions take place:
  - If `TTI State` was previously activated but in a different state (such as, a voice to data state), the old TTI translations are removed and the new ones added on a board by board basis.
  - If `TTI State` is set to **voice**, then default TTI translations are generated for every unadministered port on all digital, hybrid, and analog boards.
  - If `TTI State` is set to **data**, then default TTI translations are generated for every unadministered port on all digital and data line boards in the system.
  - Whenever a new digital board is inserted when the system is in TTI Data mode, or when a digital, hybrid, or analog board is inserted when the system is in TTI Voice mode, the unadministered ports on the board become TTI ports.
  - When TTI is deactivated, all translation for the TTI ports are removed in the system; the ports return to an unadministered state.
- When a set is successfully merged or separated through the use of TTI, the transaction appears in the system transaction log.

## Interactions

---

- Attendant

Because the attendant is a central focus for incoming calls, you should have the attendant in Position Busy mode. This routes incoming calls away from an attendant attempting to separate. It is possible to have the attendant in Position Available Mode and still separate. Any calls queued, held, or seen as active for the attendant prevent separation.
- Attendant Night Service

The night service station cannot be separated while in night service.
- Attendant Release Loop Operation

All calls held with the release loop operation by the attendant are reclassified as attendant group calls if the attendant separates before the attendant-timed reminder-interval expires.
- Automatic Callback

If a station has Automatic Callback active for another station, executing TTI separate for either station breaks the automatic callback sequence.

## 4 Basic Features

### *Terminal Translation Initialization*

Page 4-589

- Bridged Call Appearance

If a station has a bridged call appearance of an off-hook station, the station with the bridged call appearance can separate at any time and not disrupt a call in progress. Likewise, the principal can separate without disrupting an active call on its bridged appearance.

If a station with a bridged call appearance merges itself while the extension for the bridged appearance is active on a call, that station can join the call after it has completed the merge sequence.

- Call Coverage

If a station separates while Send All Calls or Goto Coverage is active, these features remain active while the station has no hardware translation.

You can separate a station that is the target of Send All Calls or Goto Coverage; the features function as if the station were busy.

- Call Coverage Answer Group

If a station was AWOH, then rejoins the group as a result of a TTI merge, a PSA associate, or administrative port assignment, that station is excluded from all transactions already active in the call coverage answer group.

- Call Forwarding

A station can separate while Call Forwarding is active. If a destination extension for call forwarding separates, Call Forwarding to that extension remains active. Calls forwarded while the station is separated hear a busy signal.

- Call Pickup

If a line appearance is available, a member of a call pickup group may separate at any time. If a call is attempting to terminate, and a member of a group associates, that member does not join the group for the call that is currently in progress, but is available for all subsequent calls to that group.

- Customer Provided Equipment Alarm

A station administered with a CPE alarm will retain that alarm indication when it is merged.

- Expert Agent Selection

Station user records cannot be shared between TTI ports and EAS login ID extensions. This reduces the number of possible TTI ports your system provides, depending on the number of administered EAS login IDs. For example, if you administer 2,000 EAS login IDs, the maximum number of TTI ports that the system can provide is reduced by 2,000.

- Hunt Group Uniform Call Distribution/Direct Department Calling

The system excludes stations previously AWOH as a result of a TTI separate, a PSA dissociate, or administration from all transactions already active in the hunt group when the station is merged.

## 4 Basic Features

### *Terminal Translation Initialization*

Page 4-590

- Message Light

Messages need not be deleted prior to separation. If a station receives messages while it is in the untranslated state, the message lamp is updated when the terminal receives hardware translation.

- Personal Station Access

TTI must be enabled for the system to use PSA to allow an individual user to have TTI-like capabilities for a single station.

- Save translations

All port translations made using TTI are saved when you save translations.

- Send All Calls

Send All Calls remains active when a station becomes separated.

- Terminating Extension Group

If any member of the TEG previously AWOH as a result of TTI, PSA or station administration is merged, that member is excluded from all transactions already taking place in the TEG when that member is merged. This means that a member that merges does not have access to a call already active in the TEG. The member is able to join in all subsequent calls to the group.

- Transfer

After a connection has been established from the first to the third party, the second party, the one who performed the transfer, can be separated.

## Terminating Extension Group

---

Terminating Extension Group (TEG) allows an incoming call to ring as many as 4 voice terminals at one time. Any user in the group can answer the call.

### How to administer TEG

---

#### Required forms

---

| Form                        | Field   | Page                  |
|-----------------------------|---|-----------------------|
| Terminating Extension Group | <ul style="list-style-type: none"> <li>■ All</li> </ul>   | <a href="#">5-295</a> |
| Station (multiappearance)   | <ul style="list-style-type: none"> <li>■ Button/Feature Button Assignments                             <ul style="list-style-type: none"> <li>— term-x-gr (Grp:___)</li> <li>— exclusion</li> <li>— send-term (Grp:___)</li> <li>— aut-msg-wt (Ext:___)</li> </ul> </li> <li>■ Bridged Call Alerting</li> </ul> | <a href="#">6-14</a>  |

### Detailed description

---

You can administer any voice terminal as a TEG member; however, only a multiappearance voice terminal can be assigned a TEG button with merged-status lamp. The TEG button allows the user to select a TEG call appearance for answering or bridging onto an existing call but not for call origination.

When an incoming call is answered by a TEG member, a temporary bridged appearance is maintained at the multiappearance voice terminals in the group. However, this appearance is not visible. Any TEG members can bridge onto the call by pressing the TEG button.

### Considerations

---

- A voice-terminal user can be a member of more than one TEG, but can have only one TEG button for each group.
- A TEG can handle only one TEG call at a time. Additional calls do not reach the TEG. If a coverage path is assigned to the TEG, the additional calls route accordingly.

## Interactions

---

- Automatic Callback

This feature cannot be active for a TEG.
- Bridged Call Appearance

Calls to a TEG cannot be bridged, except via a Temporary Bridged Appearance.
- Call Coverage

A TEG can have a Call Coverage path assigned, but cannot be a point in a Call Coverage path.

A Send Term button for the TEG can be assigned to group members who have multiappearance voice terminals. When a user presses Send Term, calls to the TEG redirect to coverage. The merged status lamp lights on all voice terminals with a Send Term button. Any member with a Send Term button can deactivate Send Term by pressing the button. Incoming calls are again directed to the group.
- Call Park

A TEG call cannot be parked on the group extension. However, a group member answering a call can park a TEG call on their own extension.
- Direct Department Calling and Uniform Call Distribution

A TEG cannot be a member of a DDC or UCD group.
- Internal Automatic Answer

TEG calls are not eligible for IAA; however, calls placed to an individual extension are eligible.
- Leave Word Calling

LWC messages can be stored for a TEG and can be retrieved by a member of the group, a covering user of the group, or a system-wide message retriever. Voice Terminal Display and proper authorization can be assigned to the message retriever. Also, a remote Automatic Message Waiting lamp can be assigned to a group member to provide a visual indication that a message has been stored for the group. One indicator is allowed per TEG.
- Privacy — Manual Exclusion

Privacy — Manual Exclusion can be assigned to any of the voice terminals in a TEG to prohibit bridging by other group members. A TEG member who attempts to bridge onto a call with Privacy — Manual Exclusion active is dropped.



**4 Basic Features**

*Terminating Extension Group*

*Page 4-593*

- **Temporary Bridged Appearance**

At multiappearance voice terminals in the TEG, a temporary bridged appearance is maintained after a call is answered. Other members of the group can thus bridge onto the call.

## Timed Reminder and Attendant Timers

---

Timed Reminder automatically alerts the attendant after an administered time interval. The attendant can reenter the call and decide whether to terminate the call or permit the waiting to continue.

### How to administer Timed Reminder and Attendant Timers

---

#### Required forms

---

| Form               | Field                    | Page                 |
|--------------------|--------------------------|----------------------|
| Console-Parameters | ■ No Answer Timeout      | <a href="#">5-86</a> |
|                    | ■ Alerting               |                      |
|                    | ■ Timed Reminder on Hold |                      |
|                    | ■ Return Call Timeout    |                      |

---

### Detailed description

---

Use this feature for the following types of calls:

- Extended calls waiting to be answered or waiting to be connected to a busy single-line voice terminal
- One-party calls placed on hold by an attendant
- Incoming calls that are answered by a voice-terminal user, transferred and unanswered.

Attendant Timers include:

- Unanswered DID Call Timer — Specifies how long a DID call can go unanswered before it routes to the administered DID/TIE/ISDN Intercept Treatment.
- Attendant Return Call Timer — For unanswered calls that were extended by the attendant, they are returned to the same attendant who released them if the attendant is available. Otherwise they return to the attendant-group queue. The Attendant Return Call Timer is not set for calls extended from one attendant to another individual attendant.

## 4 Basic Features

### *Timed Reminder and Attendant Timers*

Page 4-595

- **Attendant Timed Reminder of Held Call Timer** — Specifies how long a call is held. When the timer expires, the held call alerts the attendant. The message `hc` appears on the attendant display. You can administer either a high-pitched ring or a primary alert.

**Attendant No-Answer Timer** — Specifies how long a call that terminates at an attendant console can ring with primary alerting. When the call reaches this interval setting, it rings with a secondary, higher-pitch ring. A disabled Attendant No Answer Timer's ringing pattern does not change over from the primary to the secondary pattern. If the call remains unanswered during this interval, it routes to the attendant group and console where the call was placed in a Position Busy state. This feature does not apply to calls placed to the attendant's personal number or to calls originated by the attendant.

- **Attendant Alerting Interval (Timed Reminder)** — Specifies how long a call that terminates at an attendant console can ring with secondary alerting. When the call reaches this interval, the attendant console is placed into position busy mode and the call forwards to the attendant group. If the console where the alerting interval is reached is the last active day console, then the system goes into night service if night service is enabled. This feature does not apply to calls placed to the attendant's personal number or to calls originated by the attendant.

You can disable the alerting interval. In this case, a call continues to ring at the original attendant's extension until the caller hangs up or another feature disconnects the call (for example, reaching the timeout limit for unanswered DID calls during night service.)

- **Line Intercept Tone Timer** — Specifies how long line intercept can be. For example: `LITT:10` seconds means that line intercept stops after 10 seconds.

The attendant no answer and alerting timers do not apply to calls placed to the attendant's extension. And they do not apply to calls originated by the attendant.

## Considerations

- Timed Reminder informs the attendant that a call requires additional attention. After the attendant reconnects to the call, the attendant explains that the user can either try another extension, hang up, or continue to wait. This personal attention can help establish rapport with clients and customers.
- Assign the Timed Reminder intervals separately for calls waiting for connection and for calls placed on hold. Each interval can be from 10 seconds to 17 minutes.
- If a call routes to each attendant and remains unanswered, the system goes into night service. If this happens too frequently, you can lengthen the timer intervals.

## Interactions

---

- Attendant Call Waiting

An attendant-extended call to a busy single-line voice terminal returns to an attendant if the Timed Reminder Interval expires before the call answers or redirects to coverage.

- Call Coverage

If a voice-terminal user transfers a call to an on-premises voice terminal and the call remains unanswered at the expiration of the Timed Reminder Interval, the call redirects to an attendant. Redirection occurs even if the call redirects via Call Coverage or Call Forwarding from the transferred-to voice terminal.

An attendant-extended call redirects to coverage instead of returning to an attendant if the coverage criteria are met before the Timed Reminder Interval expires. However, unanswered calls return to an attendant at the expiration of the interval.

If a call alerts an attendant as a coverage call (unanswered station-to-station call with the "attd" (attendant) in the called station's coverage path form), the secondary alerting tone does not sound.

- Centralized Attendant Service

If an attendant at the main location transfers a call from a branch location to an extension at the main location, the timed reminder does not apply and the call does not return to the attendant if unanswered.

- Transfer

A transferred call that times out redirects to an attendant after an interval equal to the Attendant Return Call timer.

## Transfer

---

Transfer allows voice-terminal users to transfer trunk or internal calls to other voice terminals or trunks without attendant assistance.

### How to administer Transfer

---

#### Required forms

---

| Form                              | Field   | Page                  |
|-----------------------------------|---|-----------------------|
| Feature-Related System Parameters | ■ Music on Transferred Trunk Calls              | <a href="#">5-123</a> |
|                                   | ■ Intercept Treatment on Failed Trunk Transfers |                       |

---

### Considerations

---

- You can administer transferred-trunk calls to receive either music or silence if the first part of the transfer places the call on hold.
- Multiappearance voice terminals must have an idle appearance to transfer a call.
- Single-line voice-terminal users momentarily flash the switchhook or press Recall, dial the desired extension, and hang up. Multiappearance voice-terminal users press Transfer, dial the desired extension, and press Transfer again.

### Interactions

---

- Attendant Conference

This may not operate properly if the CO does not provide answer supervision. In that case, `Answer Supervision Timeout` and `Outgoing End of Dial` (on the CO Trunk Group form) must be set to the same non-zero number. `Receive Answer Supervision` must be set to **n**.

If the CO does provide answer supervision, `Answer Supervision Timeout` and `Outgoing End of Dial` must be set to **0** and `Receive Answer Supervision` must be set to **y**.
- Integrated Services Digital Network Basic Rate Interface (ISDN-BRI)

When an ISDN-BRI station, assigned with `Select Last Used Appearance` set to **y**, completes a transfer while off-hook using the handset, the user is left listening to dial tone on the last-used appearance.
- Internal Automatic Answer

Transferred calls can be answered automatically via IAA.

- QSIG Networking

If calls over an ISDN-PRI trunk are administered for Supplementary QSIG, then additional call information may display.

- Station

When a multifunction station (BRI/digital/hybrid) dials enough digits to route a call, but the call could route differently if additional digits were dialed, the station does not recognize the Conference Or Transfer buttons. The user must delay dialing for 3 seconds or dial # to indicate that the call can be routed based on the digits already dialed. The Conference Or Transfer buttons then are recognized and the switch completes the operation.

Station users cannot transfer the attendant.

## Transfer — Outgoing Trunk to Outgoing Trunk

---

Outgoing Trunk to Outgoing Trunk Transfer (OTTOTT) permits a controlling party (such as a station user or attendant) to initiate two or more outgoing trunk calls and then connect the trunks. This operation removes the controlling party from the connection and conferences the outgoing trunks. Alternatively, the controlling party can establish a conference call with the outgoing trunks and then drop out of the conference, leaving only the outgoing trunks on the conference.

### NOTE:

This is an optional enhancement to Trunk-to-Trunk Transfer and requires careful administration and use. Distributed Communication System (DCS) Trunk Turnaround may be an acceptable and safer alternative to this feature.

OTTOTT allows calls to be established in which the only parties involved are external to the switch and are on outgoing trunks. This type of call can result in locked-up trunks, such as trunks that cannot be disconnected except by busy-ing-out and releasing the affected trunk circuit. To clear the lockup, a service technician must reseal the trunk board, or busy-out and release the affected trunk.

### How to administer OTTOTT

---

#### Required forms

| Form                              | Field                        | Page                  |
|-----------------------------------|------------------------------|-----------------------|
| Trunk Group                       |                              | <a href="#">7-115</a> |
| — Access Endpoint                 | ■ Disconnect Supervision-Out | <a href="#">7-72</a>  |
| — APLT                            | ■ Disconnect Supervision-Out | <a href="#">7-156</a> |
| — CO (Central office)             | ■ Disconnect Supervision-Out | <a href="#">7-168</a> |
| — DIOD                            | ■ Disconnect Supervision-Out | <a href="#">7-183</a> |
| — DMI-BOS                         | ■ Disconnect Supervision-Out | <a href="#">7-188</a> |
| — FX (Foreign exchange)           | ■ Disconnect Supervision-Out | <a href="#">7-193</a> |
| — ISDN-PRI                        | ■ Disconnect Supervision-Out | <a href="#">7-219</a> |
| — Tandem                          | ■ Disconnect Supervision-Out | <a href="#">7-257</a> |
| — Tie                             | ■ Disconnect Supervision-Out | <a href="#">7-262</a> |
| — WATS                            | ■ Disconnect Supervision-Out | <a href="#">7-268</a> |
| Feature-Related System Parameters | ■ Trunk-to-Trunk Transfer    | <a href="#">5-123</a> |

## Detailed Description

---

You must administer at least one outgoing trunk to support OTTOTT and the network must provide network-answer supervision. The answer supervision test increases the probability, but does not guarantee, that a disconnect signal is received from the remote end of the trunk. To mitigate problems associated with its accidental use, this feature is administrable only on trunk groups on the Trunk Group form. It is not a system option.

DCS networks provide a similar but more restrictive version of this feature, called DCS Trunk Turn Around, which permits two outgoing trunks to be connected when the switch at the remote end of one of the trunks agrees to turn around the logical direction of the trunk. DCS trunk turnaround is permitted, when some other party involved in the call (at the remote switch) can provide disconnect supervision.

Without OTTOTT or DCS, a conference involving two or more outgoing trunks is permitted only when at least one remaining conference party is an attendant, incoming trunk, or station.

## Considerations

---

- OTTOTT is not intended for use in DCS networks, since DCS Trunk Turnaround provides comparable capabilities much more safely. However, use of OTTOTT with DCS is not prohibited, and may be useful when one or more of the trunks goes off the DCS network.

## Security Measures

---

### SECURITY ALERT:

*You are cautioned that this feature can be used to transfer an outside party to a trunk over which toll calls might be made. Since trunks have to be specifically administered for OTTOTT, you should examine the Class of Restriction (COR) and Facility Restriction Level (FRL) of that trunk group to determine if they are appropriate.*

### SECURITY ALERT:

*OTTOTT is not a system-wide parameter. It is administered on a trunk-group basis. You must enable Trunk-to-Trunk Transfer on the Feature-Related System Parameters form for this feature to work. If you deem that the feature is not relevant to your business practices, do not enable it. Alternately, if a temporary need presents itself, you can temporarily enable this feature and then turn it off.*



## Interactions

---

### ■ DCS Trunk Turnaround

OTTOTT increases the set of cases in which DCS Trunk Turnaround may be accepted. However, use of OTTOTT in combination with a DCS network is strongly discouraged. The following algorithm describes the DCS Trunk Turnaround request process.

- a. If any party on the call receives a local-dial, busy, intercept, or reorder tone, deny turnaround.
- b. If any remaining party is an answered station or attendant, accept turnaround.
- c. If any remaining party is on an incoming trunk, accept turnaround. For the purposes of this check, an outgoing DCS trunk that has been turned around an odd number of times via a DCS trunk turnaround is considered an incoming trunk with disconnect supervision. Similarly, an incoming DCS trunk that has been turned around an odd number of times is considered an outgoing trunk.
- d. If any remaining party is an outgoing trunk administered for OTTOTT that has received answer supervision, accept turnaround.
- e. If any remaining party is an outgoing DCS trunk, forward the turnaround request.
- f. Otherwise, deny turnaround.

### ■ Incoming Disconnect Supervision

Outside of the U.S., incoming disconnect supervision is a switch capability that restricts transfers or conferences for certain incoming trunks. In the U.S., all incoming trunks are assumed to provide disconnect supervision. In some countries this assumption is not valid, so administer whether or not an incoming trunk provides disconnect supervision for each trunk group.

### ■ Personal Central Office Lines

Transfer of personal CO lines (PCOLs) is not subject to the normal restrictions applied to transfer of other trunks. These transfers are allowed since the PCOL appearance remains on one or more stations as a feature button. System users must be aware that the DROP button cannot be used to disconnect the transferred-to party from the call. Hence, if an outgoing PCOL is transferred to an outgoing trunk and neither of the trunks can supply a disconnect signal, the two trunks lock up.

### ■ QSIG Global Networking

If either call is over an ISDN-PRI trunk administered with Supplementary Service Protocol b (QSIG), additional call information may display.

#### 4 Basic Features

##### Transfer — Outgoing Trunk to Outgoing Trunk

Page 4-602

- Release Link Trunks

RLTs are used by Centralized Attendant Service (CAS). An outgoing RLT at a remote branch is used to access an attendant at the main. The attendant at the main can transfer the incoming caller to a station or trunk at the branch. The RLT is typically used only for a short period of time and is usually idled after the transfer is established.

A station at a branch can transfer an outgoing trunk to the attendant at the main. This transfer could be viewed as an OTTOTT (the attendant is accessed via an outgoing RLT). Since administering outgoing disconnect supervision for RLT trunks provides no additional capability, this administration is not provided for RLT trunks.

- Restriction

Restrictions on the transferring party may block a transfer or drop operation even when Outgoing Disconnect Supervision is provided.

- Trunk-to-Trunk Transfer

If this feature-related system parameter is set to restricted, all trunk-to-trunk transfer/release/drop operations for public trunks (CO, CPE, CAS, DID, DIOD, FX, and WATS) have calls terminated or receive denial. If the parameter is set to none, all trunk-to-trunk transfers (except CAS and DCS) have calls terminated or receive denial.

Hence, this option must be set to all to enable OTTOTT operation for these types of trunks. The number of public-network trunks allowed on a conference call is administrable. This number defaults to 1, so if OTTOTT is being used to connect two or more public network trunks, you must increase this limit on the Feature-Related System Parameters form.

- Trunks (CO, FX, and WATS)

You cannot have two CO, FX, or WATS trunks in a OTTOTT connection, even if `Disconnect Supervision - Out` is set to **y**.

## Trunk Flash

---

Trunk Flash allows a feature or function button on a multifunction voice terminal or attendant console to be assigned as a Flash button. Pressing this button while connected to a trunk (which must have been administered to allow trunk flash) causes the System to send a flash signal out over the connected trunk.

Trunk Flash enables multifunction voice terminals to access central office customized services that are provided by the far-end or Central Office (CO) located directly behind the DEFINITY System. These central office customized services are electronic features, such as conference and transfer, that are accessed by a sequence of flash signal and dial signals from the DEFINITY System station on an active trunk call. The Trunk Flash feature can help to reduce the number of trunk lines connected to the DEFINITY switch by:

- Performing trunk-to-trunk call transfers at the far-end or CO, which eliminates the use of a second trunk line for the duration of the call and frees the original trunk line for the duration of the call.
- Performing a conference call with a second outside call party, which eliminates the need for a second trunk line for the duration of the call.



**NOTE:**

Some analog Dual-Tone Multi-Frequency (DTMF) telephone sets used in Italy and the United Kingdom are equipped with a FLASH button that, when pressed, generates a rotary digit 1. When an analog station which is administered as a DTMF station (for example, as a 2500 or 71nn-type station) transmits a rotary digit 1, the system treats the signal as a recall signal from the station set to the DEFINITY ECS.

### How to administer Trunk Flash

---

#### Required forms

| Form                             | Field               | Page                  |
|----------------------------------|---------------------|-----------------------|
| Attendant Console                | ■ All               | <a href="#">5-35</a>  |
| Feature Access Code (FAC)        | ■ Flash Access Code | <a href="#">5-113</a> |
| Station (10-MET, 20-MET, 30-MET) | ■ All               | <a href="#">6-14</a>  |

*Continued on next page*

**Required forms — Continued**

| Form                               | Field | Page                  |
|------------------------------------|-------|-----------------------|
| Station (multiappearance)          | ■ All |                       |
| — 7303S, 7305D, 7309H              |       | <a href="#">6-73</a>  |
| — 7401D, 7403D, 7404D              |       | <a href="#">6-90</a>  |
| — 7405D                            |       | <a href="#">6-99</a>  |
| — 7406D, 7404D                     |       | <a href="#">6-111</a> |
| — 7434D                            |       | <a href="#">6-121</a> |
| — 8403B, 8405B, 8405B+ 8410B       |       | <a href="#">6-172</a> |
| — 8405D, 8405D+, 8410D, 8434       |       | <a href="#">6-180</a> |
| — 8411B, 8411D                     |       | <a href="#">6-189</a> |
| — 603 CALLMASTER Terminal          |       | <a href="#">6-141</a> |
| — 515 BCT                          |       | <a href="#">6-55</a>  |
| Trunk Group                        | ■ All |                       |
| — CO                               |       | <a href="#">7-168</a> |
| — FX                               |       | <a href="#">7-193</a> |
| — WATS                             |       | <a href="#">7-268</a> |
| — Tie (for digital TN464 & TnN767) |       | <a href="#">7-262</a> |

**Detailed description**

When used by a Centralized Attendant Service (CAS) attendant connected to an Release Link Trunk (RLT), the flash controls certain CAS features at the branch. When used by a multifunction voice terminal or non-CAS attendant connected to a CO, FX, or WATS trunk, the flash controls certain features (such as add-on) at the connected CO.

Trunk Flash is not available on Personal Central Office Line (PCOL) groups.

The system supports the Trunk Flash signal for incoming, outgoing, or 2-way call directions on selected 2-wire analog (ground-start or loop-start) or digital (DS1) trunks or Tie trunks on DS1.

If the trunk group is a DS1 trunk in Italy, the Trunk Flash feature applies only to outgoing calls.

This feature may also be activated by dialing the Trunk Flash FAC as administered on the Feature Access Codes form.

When a system user presses the Trunk Flash (Flash) button, the call can involve only one trunk line. This trunk must have been administered with Trunk Flash.

If the trunk is not directly connected to the far end or CO providing the customized services, use of the Trunk Flash signal may cause the call to be disconnected by the far end or CO.

Calls made after the Flash are not recorded in Call Detail Recording (CDR) records.

## Considerations

---

### NOTE:

The Trunk Flash feature allows the station user to receive central office dial tone, and place a call that is not monitored by the DEFINITY system, and is not subject to restrictions (toll, FRL, COR, etc.). Therefore you should enable this feature with caution.

- A Trunk Flash button can be assigned on CAS attendant consoles, non-CAS attendant consoles, and multifunction stations. For CAS attendants, use of this button is limited to certain CAS features via RLT trunks. For multifunction and non-CAS attendant consoles, this button is used for the Trunk Flash feature.
- FAC activation of the trunk flash feature is allowed.
- The Flash button is used by the Trunk Flash and CAS features.
- System features (such as internal conference call, transfer, and call park) may be combined with custom services (that is, CO-based features that are activated/controlled by sending a flash signal over the trunk to the CO). However, mixing DEFINITY ECS features with custom services causes complications for the user when tracking a call. DEFINITY Systems cannot give the local station user status information on the custom services.
- The Trunk Flash feature may only be accessed if the call has only one trunk, the trunk must be outgoing from the PBX's perspective, and the trunk group of that trunk has Trunk Flash enabled. The Trunk Flash feature is disabled when the call involves more than one trunk, even if all the trunks have Trunk Flash enabled.
- Any DEFINITY ECS station can flash and dial a FAC to access the Trunk Flash feature; any DEFINITY ECS station with a flash button can access the Trunk Flash feature by hitting the flash button. The system allows as many as five stations to participate in a conference call with the trunk line party. However, to access the Trunk Flash feature, at least one of the stations must have a Flash button.

- In a call involving more than one station, one of the stations may press the Flash button, and another station may dial the phone number. The station that dials the phone number is not required to have a Flash button.
- If the far-end/CO does not support custom services, the call may be dropped by the far-end/CO on sending the flash signal or the signal may be ignored and a click-click sound is heard.

## Interactions

---

None.

## Trunk Group Busy/Warning Indicators to Attendant

---

Trunk Group Busy/Warning Indicators to Attendant provides the attendant with a visual indication that the number of busy trunks in a group is reaching an administered level.

### How to administer Trunk Group Busy/Warning Indicators to Attendant

---

#### Required forms

| Form              | Field                               | Page                  |
|-------------------|-------------------------------------|-----------------------|
| Attendant Console | ■ Direct Trunk Group Select Buttons | <a href="#">5-35</a>  |
| Trunk Groups:     | ■ Busy Threshold                    | <a href="#">7-115</a> |
| — Access          |                                     | <a href="#">7-150</a> |
| — APLT            |                                     | <a href="#">7-156</a> |
| — CO              |                                     | <a href="#">7-168</a> |
| — CPE             |                                     | <a href="#">7-174</a> |
| — DMI-BOS         |                                     | <a href="#">7-188</a> |
| — FX              |                                     | <a href="#">7-193</a> |
| — ISDN-PRI        |                                     | <a href="#">7-219</a> |
| — RLT             |                                     | <a href="#">7-252</a> |
| — Tandem          |                                     | <a href="#">7-257</a> |
| — Tie             |                                     | <a href="#">7-262</a> |
| — WATS            |                                     | <a href="#">7-268</a> |

#### Detailed description

---

The feature also provides a visual indication when all trunks in a group are busy.

The two lamps that provide the visual indications are:

- Warn Lamp

Located on Trunk Hundreds Select buttons that have three lamps. The lamp lights when a preset number (warning threshold) of trunks in the associated trunk group are busy.

**4 Basic Features**

*Trunk Group Busy/Warning Indicators to Attendant*

*Page 4-608*

- **Busy Lamp**

Located at each of the 12 Fixed Trunk Hundreds Select buttons and on each feature button administered as a Trunk Hundreds Select button. The lamp lights when all trunks in the associated trunk group are busy.

- The indicators are particularly useful when you are providing Attendant Control of Trunk Group Access.

## **Interactions**

---

- **Loudspeaker Paging Access**

Trunk Group Busy Indicators allow attendants to see whether paging zones are busy or idle.



## Trunk Identification by Attendant

---

Trunk Identification by Attendant allows an attendant or display-equipped voice-terminal user to identify the trunk used on a call.

### How to administer Trunk Identification by Attendant

---

#### Required forms

---

| Form                   | Field                                    | Page                 |
|------------------------|--|----------------------|
| Attendant Console      | ■ Feature Button Assignments<br>— trk-id | <a href="#">5-35</a> |
|                        | ■ Display Language                       |                      |
| Station (7400D Series) | ■ Feature Button Assignments<br>— trk-id | <a href="#">6-90</a> |
|                        | ■ Display Language                       |                      |

---

#### Detailed description

---

Use this feature when a user is on one of the following established trunk calls:

- An incoming trunk call
- An outgoing trunk call
- A transferred or conferenced call involving a trunk
- A trunk-to-trunk call

Use the Trunk ID button during an established call, while seizing a trunk, while outpulsing digits on a trunk, or during intervals between digit outpulsing.

When you connect a user to a trunk, and press the Trunk ID button, the trunk displays. The trunk ID consists of the 1–4 digit trunk-access code for that trunk group and the 3-digit trunk-group member number.

The trunk ID that is displayed depends on the type of call in process. If the call is incoming, the incoming trunk ID displays. If the call is outgoing, the outgoing trunk ID displays. If the call is trunk-to-trunk, the last trunk added to the call displays.

## Considerations

---

- This feature is particularly useful for identification of a faulty trunk. That trunk can be removed from service and the problem quickly corrected.
- Allow a maximum of one Trunk ID button per attendant and voice-terminal with a display.
- The feature is denied if there are more than two trunks on the call or if there are exactly two trunks on the call and the station pressing the Trunk ID button is not the controlling party.
- When a conference results from an incoming call followed by an outgoing call, the last trunk added to the conference is the incoming one.

## Interactions

---

- Attendant Display and Voice Terminal Display

Any action by the user or the system that changes the display removes the trunk ID currently displayed. The Trunk ID button lamp remains lighted as long as the call is active. When the lamp lights, the user can use the associated button to redisplay the trunk ID.

If the Trunk ID button is pressed during a call origination (before all digits are dialed), the trunk ID appears. On a voice terminal-display, any subsequently dialed digits do not display. On an attendant display, the subsequently dialed digits overwrite other digits on the display.

- Busy Verification

A trunk being busy-verified can be identified.

- Hold

A trunk held by a user cannot be identified.

## Trunk-to-Trunk Transfer

---

Trunk-to-Trunk Transfer allows the attendant or voice-terminal user to connect an incoming trunk call to an outgoing trunk.

### **SECURITY ALERT:**

*Trunk-to-trunk transfer poses a significant security risk. Use this feature only with extreme caution.*

## How to administer Trunk-to-Trunk Transfer

---

### Required forms

---

| Form                              | Field                   | Page                  |
|-----------------------------------|-------------------------|-----------------------|
| Feature-Related System Parameters | Trunk-to-Trunk Transfer | <a href="#">5-123</a> |

The system provides three levels of administration for this feature: system-wide, COR-to-COR, and COS.

To administer Trunk-to-Trunk Transfer system-wide, complete the Feature-Related System Parameters form. To restrict Trunk-to-Trunk Transfer on a trunk-group basis, assign COR-to-COR calling-party restrictions on the Class of Restriction (COR) form. To allow individual users to control Trunk-to-Trunk Transfers, assign capabilities on the Class of Service (COS) form.

## Considerations

---

- Trunk-to-Trunk Transfer is particularly useful when a caller outside the system calls a user or attendant and requests a transfer to another outside number. For example, a worker, away on business, can call in and have the call transferred elsewhere.
- Transferred trunk calls can be administered to receive either music or silence.
- Some central office (CO) trunks do not signal the PBX when the CO user disconnects from a call. The system ensures that incoming CO trunks without Disconnect Supervision are not transferred to outgoing trunks or to other incoming CO trunks without Disconnect Supervision.
- An attendant-assisted call connecting an outgoing trunk or incoming trunk without Disconnect Supervision to an outgoing trunk must be held on the console. The system does not allow the attendant to release the call. The attendant can, however, use the Forced Release button and disconnect all parties associated with the call.

- If a voice-terminal user has connected two outgoing trunks or an outgoing call and an incoming call without Disconnect Supervision, the user must remain on the call. Otherwise, the call is dropped. An incoming trunk with Disconnect Supervision can be connected to an outgoing trunk without the user remaining on the call. An incoming trunk can also be connected to another incoming trunk without the user remaining on the call if one of the incoming trunks has Disconnect Supervision.

## Interactions

---

- Attendant Lockout  
Attendant Lockout does not function on Trunk-to-Trunk Transfer.
- Call Vectoring  
Station control of Trunk-to-Trunk Transfer does not affect routing of incoming trunks to a VDN that ultimately routes to a destination off-net.  
A route to a number off the switch does *not* require you to enable trunk-to-trunk transfer.
- Tenant Partitioning  
Station control of Trunk-to-Trunk Transfer is prohibited between trunks in different tenant partitions if those partitions are restricted.

## Visually Impaired Attendant Service

---

Visually Impaired Attendant Service (VIAS) allows a visually-impaired attendant to listen to voiced information about each button in Inspect mode.

### How to administer VIAS

---

#### Required forms

---

| Form              | Field  | Page                 |
|-------------------|--|----------------------|
| Attendant Console | <ul style="list-style-type: none"><li>■ Feature Button Assignments VIAS Act/Deact<ul style="list-style-type: none"><li>— console</li><li>— display</li><li>— dtgs-stat</li><li>— last-mess</li><li>— last-op</li></ul></li></ul> | <a href="#">5-35</a> |

---

### Detailed description

---

VIAS provides voice feedback to a visually-impaired attendant in either Italian or British English.

The six VIAS attendant buttons are:

- Visually Impaired Service Activation/Deactivation button: activates or deactivates the feature. All ringers previously disabled (for example, recall and incoming calls) become reenabled.
- Console Status button: voices whether the console is in Position Available or Position Busy state, whether the console is a night console, the status of the attendant queue, and the status of system alarms.
- Display Status button: voices what is shown on the console display. VIAS support is not available for all display features (for example, class-of-restriction information, personal names, and some call purposes).
- Last Operation button: voices the last operation performed.
- Last Voiced Message button: repeats the last voiced message.
- Direct Trunk Group Selection Status button: voices the status of an attendant-monitored trunk group.

The attendant presses the Inspect mode to locate each button and then presses a feature button to determine the feature assigned to the button without actually executing the feature. To end Inspect mode, the attendant presses the Normal button.

## Considerations

---

- Some changes on the attendant console automatically voiced (for example, alarms reported, night service activated, and call thresholds reached).
- VIAS does not automatically activate after system initialization. After a warm restart operation, VIAS remains activated if already activated. After recovery and cold restart operations, VIAS does not automatically activate even if already activated. Finally, whenever the attendant console goes to a busyout state and VIAS activates, VIAS automatically deactivates.

## Interactions

---

- Auto Start — Is always enabled when VIAS activates.
- Don't Split — The attendant can activate Don't Split as usual. The Don't Split automatically deactivates when the attendant deactivates VIAS.

## Voice Message Retrieval

---

Voice Message Retrieval allows attendants, voice-terminal users, and remote-access users to retrieve Leave Word Calling (LWC) and Call Coverage messages.

### How to administer Voice Message Retrieval

---

#### Required forms

---

| Form                              | Field  | Page                  |
|-----------------------------------|--|-----------------------|
| Feature Access Code (FAC)         | ■ LWC Message Retrieval Lock                     | <a href="#">5-113</a> |
|                                   | ■ LWC Message Retrieval Unlock                   |                       |
|                                   | ■ Voice Coverage Message Retrieval Access Code   |                       |
|                                   | ■ Voice Principal Message Retrieval Access Code  |                       |
| Feature-Related System Parameters | ■ Stations With System-Wide Retrieval Permission | <a href="#">5-123</a> |
|                                   | ■ Message Waiting Lamp Indicates Status For      |                       |
| Station                           | ■ Security Code                                  | <a href="#">6-28</a>  |

### Detailed description

---

Voice Message Retrieval is used only for the retrieval of messages. It can be used to retrieve a user's own messages or messages for another user. However, a different user's messages can be retrieved only by a user at a voice terminal or attendant console in the coverage path, by an administered system-wide message retriever, or by a remote-access user when the extension and associated security code are known.

The system restricts unauthorized users from retrieving messages. The Lock function restricts a voice terminal and the Unlock function releases the restriction. Users activate Lock by dialing a system-wide access code. They cancel Lock by dialing a system-wide access code and then an Unlock security code unique to the voice terminal. These functions apply only to the voice terminal where the function is active. The system-wide access codes and security code used for the Lock and Unlock functions are the same as those used for LWC message retrieval by display. You can assign a status lamp to show the lock status of the voice terminal.

## End-user procedures

Voice Message Retrieval is activated as follows:

- To retrieve your own messages:  
Dial the access code for Voice Message Retrieval of LWC messages. Then dial # to indicate the dialing extension, or enter a specific extension and corresponding password (same as the security code used for the Lock and Unlock functions).
- To retrieve someone else's messages:  
Dial the access code for Voice Message Retrieval of Call Coverage messages, then dial the extension of the user (within the same coverage path) whose messages are to be retrieved.

Users can get out of Voice Message Retrieval mode by:

- Hanging up
- Pressing the Drop or Disconnect button
- Activating CALL

## Considerations

- When a terminal is in Voice Message Retrieval mode, it cannot be used to make calls or access other features.
- Voice Message Retrieval cannot be accessed from rotary voice terminals.
- Certain voice terminals and attendants can be designated for system-wide message retrieval. These system-wide retrievers are the same as those used for Display Message Retrieval and have the same privileges.
- The number of simultaneous Voice Message Retrieval users possible depends on the number of speech-synthesizer circuit packs used in the system.

## Interactions

- AUDIX Interface  
Retrieval of LWC messages via Voice Message Retrieval is separate and distinct from retrieval of messages via INTUITY. LWC messages left for a principal on AUDIX may not be accessed via Voice Message Retrieval; however, the caller of Voice Message Retrieval is told if there are any new messages for the principal on AUDIX:
  - Voice Message Retrieval voices that there are AUDIX messages.
  - The Display Message Retrieval displays "Message Center AUDIX Call."



If your system has a voice-synthesizer circuit pack and LWC Activation is active, users can retrieve messages from two locations:

- Users can retrieve LWC messages with Voice Message Retrieval.
- Users can retrieve all other messages with AUDIX.

If you do not have a TN725B speech-synthesizer board, then non-display voice-terminal users cannot retrieve LWC messages that were sent via the LWC button on a voice terminal.

■ Bridged Call Appearance

Voice Message Retrieval on a Bridged Call Appearance functions the same as if it were activated by the primary extension associated with the bridged call appearance.

■ Leave Word Calling

Voice Message Retrieval enhances LWC by allowing any authorized touch-tone voice-terminal user to retrieve messages.

## Voice Messaging Systems

---

DEFINITY ECS supports several Lucent voice or multimedia messaging systems. These systems let users send, get, store, and forward messages, as well as perform many other tasks associated with messages. The systems DEFINITY ECS supports are:

**INTUITY AUDIX** INTUITY AUDIX runs on a separate MAP/5, MAP/40, or MAP/100 PC. The switch communicates with INTUITY AUDIX over analog voice ports and a data link. The switch can also communicate with INTUITY AUDIX without the data link. In this case, the switch and INTUITY AUDIX communicate by sending and receiving special strings of touch-tone codes (dual tone multifrequency tones) over the analog voice ports. These touch-tone codes are called *mode codes* and carry data such as calling party ID, called party ID, and type of call.

### NOTE:

If your system is a DEFINITY ECS R6csi (compact modular cabinet) or later, you must use the mode code integration with Intuity AUDIX.

INTUITY AUDIX allows up to 64 ports. This means up to 64 people can be simultaneously getting or leaving messages. INTUITY AUDIX also supports fax and e-mail messaging.

For more information, see *INTUITY AUDIX System Description* or *INTUITY AUDIX Administration*

**DEFINITY AUDIX** DEFINITY AUDIX runs on a TN 566 or TN567 circuit pack assembly. This assembly, called a multifunction board, fits into 5 contiguous slots in the DEFINITY switch. DEFINITY AUDIX communicates with the switch over analog voice ports with a data link. DEFINITY AUDIX can also communicate exclusively over analog voice ports when set up to emulate a digital phone set.

DEFINITY AUDIX allows up to 16 ports.

For more information, see *DEFINITY AUDIX System Feature Descriptions*, *DEFINITY AUDIX System Administration*, or *DEFINITY AUDIX System Forms Reference*

Other non-Lucent messaging systems may also use mode codes to work with DEFINITY ECS.

**How to administer the switch for voice messaging**

A service technician typically completes the initial installation and set up of your messaging system. However, the procedures on how to administer the switch for voice messaging are fully described in one of the following documents:

- For INTUITY      *INTUITY Integration with System 75 and DEFINITY*  
AUDIX            *Communications System Generic 1 and Generic 3,*  
                      585-310-214, Issue 6
  
- For DEFINITY    *Switch Administration for the DEFINITY AUDIX System,*  
AUDIX            585-300-509, Issue 6
  
- For AUDIX R1    *Switch Administration for AUDIX Voice Messaging,*  
                      585-305-505

**Related Forms**

**Related forms**

| <b>Form</b>                         | <b>Field</b>                             | <b>Page</b>  |
|-------------------------------------|--|--|
| Circuit Packs                       | ■ All on Pages 4 and 5 of the form       | <a href="#">5-69</a>                                 |
| Data Modules                        | ■ All (for one AUDIX link)               | <a href="#">6-226</a>                                |
| Packet Gateway Board (PGATE)        | ■ All                                    | <a href="#">5-246</a>                                |
| User Defined Adjunct Names          | ■ All                                    | <a href="#">5-303</a>                                |
| Interface Links                     | ■ All (for one AUDIX link)               | <a href="#">5-179</a>                                |
| Processor Channel Assignment        | ■ All (for one AUDIX link)               | <a href="#">5-248</a><br>or<br><a href="#">5-252</a> |
| Mode Code Related System Parameters | ■ All                                    | <a href="#">5-220</a>                                |
| Station                             | ■ All (for messaging system voice ports) | <a href="#">6-28</a>                                 |
| Feature Access Code (FAC)           | ■ Transfer Into AUDIX                    | <a href="#">5-113</a>                                |
| Hunt Group                          | ■ All (as required)                      | <a href="#">5-158</a>                                |

*Continued on next page*

**Related forms — Continued**

| Form                                   | Field   | Page                 |
|--|---|----------------------|
| Station<br>(User stations as required) | <ul style="list-style-type: none"> <li>■ COS</li> <li>■ LWC Reception</li> <li>■ LWC Activation</li> <li>■ Data Restriction</li> <li>■ Redirect Notification</li> <li>■ Coverage Path</li> <li>■ Call Waiting Indication</li> <li>■ Button/Feature Button Assignments               <ul style="list-style-type: none"> <li>— call-fwd</li> <li>— goto-cover</li> <li>— lwc-store</li> <li>— send-calls</li> </ul> </li> </ul> | <a href="#">6-28</a> |
| Class of Service                       | Call Fwd-All Calls  | <a href="#">5-81</a> |
| Coverage Path                          | All   | <a href="#">5-94</a> |

**How to administer voice messaging for a DCS configuration**

See [“Distributed Communications System” on page 12-11](#) for a listing of required forms.

**Security Measures**

 **SECURITY ALERT:**

*Fraudulent long-distance calls can be placed through INTUITY AUDIX, DEFINITY AUDIX, and AUDIX R1 if proper security precautions are not implemented.*

The following actions help secure your system from unauthorized use.

- For INTUITY AUDIX, DEFINITY AUDIX, and AUDIX R1
  - To help prevent exchange of information through unassigned Voice Mail, remove any unused or unassigned mail.
  - Secure system lines that serve AUDIX and control where calls can be placed. Pay special attention to assigning restrictive COR, COS, and FRL to the station lines and trunks serving AUDIX. Use switch CDR reports to determine if the lines are being used for calls that are normally not within your sphere of business.
  - Change default passwords on voice mailboxes immediately after installation and use random numbers for passwords.
  - Require passwords with at least 5 digits.
  - Change system administration passwords to alphanumeric codes.
  - INTUITY AUDIX, AUDIX R1, and DEFINITY AUDIX provide a maintenance/administration port. A remote port security device provides an added layer of security to prevent unauthorized access to this port.
- For INTUITY AUDIX and DEFINITY AUDIX
  - Determine whether to allow transfers only to other AUDIX subscribers or to any extension of the correct length. The most secure approach is to allow transfers only to other AUDIX subscribers. If you decide to allow transfers to any extension, administer the COR on the AUDIX ports to prevent calls outside the PBX or immediate DCS site network.
- For AUDIX only
  - To help prevent having billable calls placed from unauthorized transfers outside of the system, activate Enhanced Call Transfer (ECT). ECT performs call transfer over the data link between AUDIX and the DEFINITY ECS. (The destination extensions must be administered on the switch dial plan.)

## Considerations

- In addition to supporting multiple AUDIX systems, DEFINITY can have multiple hunt groups associated with a single AUDIX system. This allows partitioning of the voice ports into different hunt groups and different coverage paths to cover different voice ports. Thus voice ports can be reserved for particular users or groups of users (for example, those that use particular coverage path).

- The following features do not use coverage paths:
  - Transfer into AUDIX with the feature access code or the GOTO COVER button
  - Last Call
- If a local AUDIX and a remote AUDIX use the same hunt-group numbers, calls route to the local hunt group.

## Interactions

---

- Attendant Conference

An attendant who has split a call can conference the call with AUDIX by dialing the Transfer Into AUDIX access code. The attendant presses Release to drop out of the conference call.
- Automatic Call Distribution (external AUDIX only)

You can administer a hunt group as an AUDIX ACD split. You can then obtain AUDIX traffic measurements with the ACD Call Management System. Login occurs when AUDIX signals the switch to make a voice port available for AUDIX service. Logout occurs when AUDIX signals the switch to disable the port.

AUDIX and ACD CMS must be connected to the same switch. If AUDIX in the DCS feature is active, a CMS located on a switch other than the host switch (AUDIX location) does not provide measurements for the AUDIX ports.

Because AUDIX frequently takes voice ports in and out of service for maintenance testing, high login activity may be seen for the AUDIX split in the measurement reports.

On CMS reports that display an agent's login ID, AUDIX voice ports always show a login ID that is the same as the extension, even if you have not administered login IDs on the switch.
- Call Coverage

When a coverage call successfully completes to AUDIX or routes from a remote switch to the host switch because of coverage, the principal is dropped from the call (no temporary bridge appearance is maintained).

Coverage calls from a remote switch that fail to reach AUDIX as a coverage point cannot be returned to the original coverage path on the remote switch.
- Call Forwarding

An AUDIX user can forward calls to a remote AUDIX hunt group or to the host AUDIX hunt group. You must correctly administer the AUDIX destination for the remote AUDIX hunt group.

- Call Monitoring

Call Monitoring allows users to pick up the handset after the call goes to AUDIX to listen to the message being left by the caller. This allows the user to determine whether they want to talk to the caller or let them complete their message.

- Call Transfer

A call transfer out of AUDIX can be to a UDP extension. If the UDP extension is on a remote switch, the call is treated as a direct call. Additional trunks are used for calls transferred between DCS nodes.

Calls may be transferred into AUDIX by users handling redirected calls for principals who are AUDIX subscribers.

- Class of Restriction

A high FRL assigned in the COR allows callers to transfer to long-distance numbers.

To prevent toll fraud, assign a low FRL to the AUDIX system ports.

- DCS — Leave Word Calling (external only)

In a DCS network, the called party may be on a different switch than the calling party. If the DCS link is down, attempts to store Leave Word Cancel messages are denied and intercept tone is returned. LWC requests are always denied for principals with AUDIX LWC; in some instances, the request to cancel LWC may appear to be active when it actually is not (see [“Leave Word Calling” on page 4-405](#)).

When the local switch communicates with INTUITY AUDIX via mode codes, INTUITY AUDIX cannot support remote DCS switches.

- Facility Test Call

Unauthorized calls can be placed using the facility test-call access code.

To prevent toll fraud, remove the facility test call access code.

- Leave Word Calling

You can have a principal's LWC messages kept by AUDIX. The principal can retrieve a message by calling AUDIX. The principal cannot retrieve the message using other retrieval methods, but is notified of its existence by AUDIX.

For other messaging services, you can have AUDIX report the existence of waiting LWC messages for the principal, but not the message content. The principal can retrieve the message using other retrieval methods, but is still notified of the existence of AUDIX messages.

If the data link between the system and AUDIX is down, attempts to activate LWC for an AUDIX-covered principal are denied and reorder tone is returned.

If a caller attempts to cancel a LWC message sent to AUDIX, the caller receives intercept tone if the called party is on the same switch. The caller receives confirmation tone if the called party is on another switch in the DCS network as long as the DCS data link to the called party's switch is operational, even though the message is not actually canceled.

When the local switch communicates with INTUITY AUDIX via mode codes, INTUITY AUDIX does not accept or store LWC messages in user mailboxes.

- Ringback Queueing

Ringback Queueing does not apply to AUDIX calls. On direct calls to a remote AUDIX, if all trunks to the host AUDIX are busy, busy tone is returned. On coverage calls, if all trunks are busy, AUDIX is treated as a busy coverage point. If there are coverage points after AUDIX, then the call terminates at those points.

- Single-Digit Dialing and Mixed-Station Numbering

AUDIX is designed for use with a Uniform Dial Plan. It supports only one extension length (3-, 4-, or 5-digit) that is used by AUDIX subscribers. Single-Digit and Mixed Station Numbering cannot be used. However, nothing prohibits connecting a switch to AUDIX that provides these features, as long as all AUDIX subscribers have the same extension length.

- Temporary Bridged Appearance

Stations that normally have a temporary bridged appearance with their coverage point do not have that appearance if the coverage point is AUDIX.



## Voice Terminal Alerting Options

---

Voice Terminal Alerting Options provide a range of audible ringing treatments for digital and hybrid multiappearance voice-terminals calls to off-hook and active/idle CALLMASTER voice terminals.

### How to administer Voice Terminal Alerting Options

---

#### Required forms

---

| Form   | Field                    | Page                 |
|--|--------------------------|----------------------|
| Station<br>(Digital, Hybrid, and CALLMASTER) | ■ Active Station Ringing | <a href="#">6-28</a> |

---

### Considerations

---

- Voice Terminal Alerting Options do not affect ringing to on-hook terminals. These terminals always ring audibly until the call is answered, redirected, or abandoned.
- This option is not available with analog voice terminals, multibutton electronic telephones (MET), and ISDN-BRI voice terminals.

### Interactions

---

- Bridged Call Alerting  
Bridged call appearances ring audibly when a call is directed to that station. The audible alerting applied to the station is determined by the Voice Terminal Alerting Option that you administered on the station that is ringing.
- Distinctive Ringing  
A system can still be administered for Distinctive Ringing.
- Priority Calling  
When the Voice Terminal Alerting Option is set to audible ringing, priority calls still receive distinctive audible alerting.
- Ringing — Abbreviated and Delayed  
When you enable per-button ring control, this feature is disabled.

## Voice Terminal Display

---

Voice-terminal displays provide multiappearance voice-terminal users with updated call and message information. The information displayed depends upon the display mode selected by the user. Users may also select any of the following as the display language: English (default), French, Italian, Spanish, or user-defined.

This feature provides an instant display of information associated with certain system features, functions, and services. Information that allows personalized call answering is available on many calls. Retrieving stored information, such as messages and directory information, is easy as well as convenient.

### How to administer voice terminal displays

---

#### Required forms

---

| Form                                      | Field   | Page                 |
|---|---|----------------------|
| Station (7400D and 8400D voice terminals) |   | <a href="#">6-90</a> |
| — Station page                            | <ul style="list-style-type: none"> <li>■ Data Module</li> <li>■ Display Module</li> <li>■ Display Language</li> </ul> |                      |
| — Data Module page                        | <ul style="list-style-type: none"> <li>■ All</li> </ul>   |                      |
| — Display Module page                     | <ul style="list-style-type: none"> <li>■ All</li> </ul>   |                      |

### Detailed description

---

You can assign several modes to buttons. Users access these modes by pressing the assigned button on the display module or voice terminal. All buttons are administrable.

- Normal mode

Displays call-related information for the active call appearance. This display includes information identifying the call appearance, calling- or called-party name, and calling or called number, depending on the type of call.

Elapsed Time is a display feature that can be invoked anytime the display is in Normal mode. It displays elapsed time in hours, minutes, and seconds. Timing starts or stops when the button is pressed.

- Inspect mode

Displays call-related information for an incoming call when the user is active on a different call appearance.

- Stored Number mode

Displays one of the following numbers:

- The last number that the user dialed (Last Number Dialed)
- The number stored in an Abbreviated Dialing button administered to the voice terminal
- A number stored in an Abbreviated Dialing list
- A number assigned to a button that was administered via Facility Busy Indication

- Date and Time mode

Displays the current date and time of day.

- Integrated Directory mode

Turns off the touch-tone signals and allows the user to use the touch-tone buttons to enter the name of a system user. After a name is entered, the display shows the name and extension.

Integrated Directory can use 1 additional button:

- Call-Disp  
Automatically returns the call requested by the currently-displayed message or the currently-displayed name and extension.

- Message Retrieval mode

Retrieves messages for voice-terminal users. If no messages are stored, display shows `NO MESSAGES`. Messages can be retrieved even if the retriever is active on a call.

Message Retrieval can use 3 additional related buttons:

- Next Message  
Retrieves the next message or displays `END OF FILE, PUSH Next TO REPEAT` when in Retrieval mode.
- Delete  
Deletes the currently displayed message.
- Call-Disp  
Automatically returns the call requested by the currently-displayed message or the currently-displayed name and extension.

- Coverage Message Retrieval Mode

Retrieves messages for voice-terminal users who do not have a display module assigned to their voice terminal. You must administer retrieval permission for a user to be able to retrieve another user's messages. The retriever does not need to lift the handset to retrieve messages. Messages can be retrieved even if the retriever is active on a call.

Coverage Message Retrieval can use 3 additional related buttons:

— Next Message

Retrieves the next message or displays `END OF FILE, PUSH Next TO REPEAT` when in Retrieval mode.

— Delete

Deletes the currently displayed message.

— Call-Disp

Automatically returns the call requested by the currently-displayed message or the currently-displayed name and extension.

DEFINITY ECS provides the following call-related information:

■ Call Appearance Identification

The call appearance buttons are designated on the display by a lowercase letter. The display shows `a=` for a call incoming on the first button, `b=` for a call incoming on the second button, and so on.

■ Calling Party Identification

When a call is from inside the system, the display shows the caller's name or a unique identification administered for the voice terminal being used, along with the calling party's extension. When the call is from outside the system, the display shows the trunk group name (such as CHICAGO) and the trunk access code assigned to the trunk group used for the call. If a user is active on a call, and receives a subsequent call the display automatically shows the identification of the subsequent caller for a few seconds, then automatically restores the display associated with the active call appearance.

■ Called Party Identification

On calls to a system user, the display shows the digits as they are dialed. After the dialing is complete, the display shows the called party's name and extension. If no name is accessed, the dialed digits are displayed.

On outgoing calls, the display shows the digits as they are dialed. After dialing is complete, the display shows the name and trunk access code assigned to the trunk group being called. Optionally on a trunk-group basis, the display can show only the dialed digits, not the trunk group name and trunk access code.

■ Call Purpose

This identifies the reason for an incoming call or a redirected call. (A normal incoming call is not identified by a call purpose.) The following identifiers may be displayed:

- b — Busy — The called voice-terminal user is active on a call, and has a temporary bridged appearance of the call.
- B — Busy — The called voice-terminal user is active on a call, and does not have a temporary bridged appearance of the call.
- c — Cover All — The called user has Cover All criteria assigned.
- callback — The call is an Automatic Callback call from the system.
- d — Coverage on Don't Answer — The call was redirected because the called voice terminal was not answered. Also indicates that the called voice-terminal user has a temporary bridged appearance of the call.
- f — Call Forwarding — Another user has forwarded calls to this voice terminal.
- h — Station hunt — The called voice-terminal user is active on a call and station hunt was used to route the call.
- ICOM — The call is an Intercom call.
- p — Pickup — The user answered a Call Pickup group member's call.
- park — The user parked a call.
- priority — The call has priority status.
- s — Send All Calls — The called user is temporarily sending all calls to coverage and the call has been redirected to this voice terminal.

## Considerations

- Certain voice terminals and the attendant group can be designated for systemwide message retrieval. Users of these voice terminals or consoles can retrieve Leave Word Calling (LWC) and Call Coverage messages for other voice-terminal users, including Direct Department Calling (DDC) groups, Uniform Call Distribution (UCD) groups, and Terminating Extension Groups (TEG). You can assign systemwide retrieving voice terminals or consoles on the Feature-Related System Parameters form.
- If the following conditions are met, messages for a voice-terminal user can be retrieved at selected terminals or any attendant console:
  - The retriever is in the user's Call Coverage path.
  - Permission to retrieve messages is assigned for the user's voice terminal.

- When all messages have been displayed and deleted for an extension, the Message lamp on the voice terminal and any associated Remote Message Waiting indicator, if assigned, go dark.
- Due to space limitations, some name displays are truncated to 15 characters. These include displays for transferred or covered calls, non-DCS ISDN-PRI call displays, VDN service observing displays, and when accessing Leave Word Calling messages or checking the queue status of an agent.

### Examples of Voice Terminal Displays

The following figures provide examples of typical voice terminal displays:

- Internal call

dialed digits

a=3602

then

a=TOM BROWN 3062

or, if no name is available

a=EXT 3602 3062

- Outgoing trunk call

b=87843541

Where 8 is the trunk access code and 784-3541 is the number dialed

then

b=OUTSIDE CALL 8

or

b=WATS 101

- Incoming trunk call

a=OUTSIDE CALL 102

Where 102 is the trunk access code of the incoming trunk group

- Conference call

b= CONFERENCE 4

Where 4 is the number of conferees, not including the conference-call originator

- Internal call redirected to coverage

b=EXT 3174 to EXT 3077 d

or

b=BOB SMITH to JOYCE THOMAS d

Where d indicates that Go To Cover is active for the calling user

- Incoming trunk call redirected to coverage

b=OUTSIDE CALL to DON SMITH s

Where s indicates that Send All Calls is active for the called user

- Message Retrieval

IN PROGRESS

then

MESSAGES FOR BETTY R. SIMS

then

JOE JONES 10/16 11:40a 2 CALL 3124

Joe Jones called Betty Sims at 11:40 a.m. on October 16. Joe wants Betty to call his extension, 3124.

- Integrated Directory mode

CARTER, ANN 3408 3

This display shows the name and extension. The 3 indicates that three buttons were pressed to reach this display.

## Interactions

---

- Bridged Call Appearance

A call from the primary extension or a bridged call appearance of the primary extension is displayed as a call from the primary extension.
- Last Number Dialed

If the Last Number Dialed feature access code is dialed after the stored number button is pressed, the last number dialed is not displayed. However, if the Last Number Dialed button is pressed after the stored number button is pressed, the last number dialed is displayed.
- Single-Digit Dialing and Mixed-Station Numbering

If prefixed extensions are used in the system's dial plan, the prefix is not displayed when the extension is displayed. The Return Call button can be used to dial prefixed extensions, because the system dials the prefix, even though it is not displayed.



## Whisper Page

---

Whisper Page allows station users to make and receive barge-in announcements to and from other station users without anyone else on the calls being aware of the announcements. The TN2182, TN768, or TN780 circuit pack must be administered. These station users must have an administered class of restriction (COR) that provides for intraswitch calling.

### How to administer Whisper Page

---

#### To administer a COR that provides for intraswitch calling

On the Station form, assign a COR that provides for intraswitch calling.

#### To administer an FAC for users who do not have feature buttons

On page 3 of the Feature Access Code form, assign a FAC in the `Whisper Page Activation Access Code` field.

Make sure the code conforms to the system-wide dial plan.

#### To administer a barge-in tone that is different from the default tone

##### NOTE:

You can only use a barge-in tone that is different from the default tone if you have the TN2182 or TN780 circuit pack administered. If you have the TN768 circuit pack administered, you must use the default tone. If you have a mixture of different tone/clock circuit packs in your system, you should not administer a barge-in tone that is different from the default tone.

1. On the first page of the System-Parameters form that has no tone assigned, enter **whisper page** in the `Tone Name` field.
2. Enter a tone frequency and level in the `Tone Frequency/Level` field.

You can press help to see available options.

#### To administer buttons

On the Station form, administer the new buttons.

## To administer user-defined language for displayed messages

If the displayed language is set to “user-defined” for any user in the system, change the translation for each “user-defined” message to the language that the user requests.

1. Enter **change display-messages self-administration** command to access the 3-page change display-messages self-administration form.
2. Change the translation for each “user-defined” message to the language that the user requests.

## Detailed description

---

You administer Whisper Page by assigning a FAC or programming a feature button with a lamp to the terminal. To activate Whisper Page, a user dials the FAC or presses the feature button, and then dials the extension of the user they are trying to reach.

- If the paged party is not busy, this Whisper Page activation is converted to a nondivertable priority station-to-station call. This priority call is labeled as nondivertable because all switch diversion features are overridden by this call. For example, if the station user has Call Forwarding — All Calls enabled, this nondivertable priority call still rings the dialed station in which “normal” priority calls follow the forwarding treatment of the station.
- If the paged party is busy, the paging party, the paged party, and all parties on the call hear a tone being played to announce the intrusion. After the tone is complete, the paging party is able to speak to the paged party only. The paging party is not heard by any other party, and the paged party is not able to hear any portion of the existing call. The paged party can ignore the page or choose to answer it.

The station forms for all the supported multifunction terminals need to include the new button types that are administrable on station buttons.

These new feature buttons are:

- Answerback -> “whisp -anbk”
- Whisper Page Activation -> “whisp -act”
- Whisper Page Off -> “whisp -off”

Any station user who anticipates receiving Whisper Pages may wish to be administered with a whisp-anbk button. Attendant consoles are only permitted to have the whisp-act feature button administered on the console, because they can never be recipients of Whisper Page.

An error message displays when administering whisp-off on a soft key. This button cannot be allowed to be administered on a softkey, because there is no simple means to remind the station user that the feature is active on the terminal.

An error message displays when someone attempts to administer any of these buttons on an unsupported terminal type or on any terminal where the G3 version is not set to V6 or greater.

A new tone type, Whisper Page Announce, allows customers to customize the tones to whatever they desire. This tone plays during the activation of the Whisper Page feature. It plays to all parties on the call, including the originator, to indicate that a page is occurring. The default tone is 440-Hz for a duration of 600 msec. There is a new keyword for the set of keywords for the `Tone Name` field. This keyword is "whisper-page."

Any station user who wishes to answer Whisper Pages can have an answerback feature button administered on their terminal. By pressing this button on the terminal, the paged party places the original caller on hold on the active call appearance, and automatically establishes a 2-way communication path with the paging party on another call appearance. The paged party can treat the paging party and the original call as two separate calls through standard call processing.

A station user can turn the Whisper Page feature off by pressing a Whisper Page Off button before call setup or during the call duration. You cannot administer this feature button on a softkey, and you program it on a feature button associated with a lamp. The lamp with this feature button indicates to the user when they are and are not available for "Whisper Pages" from other users.

The 6400-, 7400-, 8400-, and 9400-series DCP terminals support the use of the Whisper Page feature.

See *6400-Series Single-Line Telephone User's Guide* (555-230-738) and *6400-Series Multi-Line Telephone User's Guide* (555-230-739) for more information about user interactions.

## Interactions

---

- Attendant Auto-Manual Splitting  
If this feature is active against a specified station, any Whisper Page activation towards that station is denied.
- Attendant Display — 8 Character  
The display shows the extension number of the station that the attendant is paging.
- Attendant Display — 40 Character  
The display shows "Whisper to" and the name and extension of the station that the attendant is paging.

- Attendant Intrusion

If this feature is active against a specified station, any Whisper Page activation toward that station is denied. Also, when a Whisper Page is active on a station, Attendant Intrusion activation against that extension is denied. The attendant receives reorder tone and a lamp flutter when the feature is activated from a feature button.

- Attendant Override of Diversion Features

Whisper Page provides override capability for the following system-level diversion features:

- Call Forward All Calls
- Call Forward Busy
- Call Forward Don't Answer
- Send All Calls
- Go To Cover
- Call Coverage

In cases in which these features are active and the station user is not busy, the station rings with priority ringing. This is done to alert the primary extension owner to an important call.

In the case in which these features are active and the user is busy, Whisper Page operates normally.

- Automatic Incoming Call Display

The automatic incoming call display shows “Whisper to” and the name and extension of the station that the attendant is paging.

The following items indicate the required interactions with the incoming display when other display affecting features are enabled on the paged party's terminal:

- Bridged Call Appearance
  - Only the terminal designated as the principal extension owner is given the “Whisper from...” message.
- Conference Call
  - Only the member of the conference call that is paged receives the update to the display with the “Whisper from...” message. All other members of the conference call do not experience a screen update.
- Date/Time Display
  - For terminals that support 1- x40-character and 2- x24-character displays, the incoming string displays for a short period of time and then is rewritten with the date/time information. For terminals

supporting 2x40-character displays, the date/time information is relocated to the bottom right-hand portion of the screen, leaving the top line for incoming messages.

An incoming Whisper Page to an idle terminal is converted to a nondivertable priority call. The normal display information for priority calls prevails when providing display updates to the paged party.

— Elapsed Timers

On receipt of the “Whisper from ...” message, the timer is relocated to the lower right hand portion of the screen on the 2-line displays. Displays with only a single line keep the timer resident toward the end of the line and only allow the beginning characters of the display to present incoming messages.

— Integrated Directory, Stored Number Display, and Message Retrieval

The standard operation for normal incoming calls prevails in these cases. No new operation is defined. Stations with Auto-Inspect enabled allow the screen update to occur temporarily, and the switch returns the user to the previous function.

■ Bridged Call Appearance

The Whisper Page feature is intended to reach a specific station user associated with a given extension number. In the case of bridged call appearances, the owner of the extension also known as the primary extension owner is the intended recipient of the Whisper Page. Whisper Page activation causes tone to be played to all parties on the call and then the announcement to only the primary station if the primary station is already online. This case is similar to a simple 2-party or multiparty conference call.

In cases in which a station other than the one associated with the primary extension is using the bridged appearance, the Whisper Page rings the primary station user’s terminal with priority ringing. This is done to alert the primary extension owner to an important call.

In cases in which all stations associated with a bridged call appearance are idle, the primary extension owner’s extension rings with priority ringing and the display is that of a normal incoming priority call.

The display for an incoming Whisper Page at the primary extension owner’s terminal is the only terminal with that call appearance that receives the incoming display message. All other terminals with the bridged call appearance do not receive a screen update.

- Busy Verification of Terminals and Trunks

When Busy Verification of Terminals is in use against a specific extension, Whisper Page is blocked from usage by any other station user in the system. The opposite is true when Whisper Page is in use and another station user attempts to perform a busy verification of the same station extension.

- Calling Number Display

Calling number display is provided in the incoming Whisper Page display message.

- Call Pick-Up Groups

If a Whisper Page activation turns into a priority call at a station that is a member of a Call Pick-Up group, that call is able to be picked up by any member of that group.

- Character Voice Terminal Display

See [“Automatic Incoming Call Display” on page 4-636](#).

- Class of Restriction (COR)

A station user must have a COR that allows for station-to-station calling in order to perform Whisper Paging to a member outside of their own COR. Inbound/Outbound calling restrictions also determine which station users can make and receive Whisper Pages. The appropriate COR must also be in place to allow attendants and other users to perform interpartition Whisper Paging within a Tenant Partition environment.

- Conference

Whisper Page activation plays the barge-in tone to all parties on the conference call while only playing the subsequent announcement from the page initiator to the owner of the station that is being paged. Whisper Page origination is denied if the page is initiated towards a station with a conference that already has the maximum number of parties and trunks. This activation is denied to prevent degradation in voice quality within the conference call.

Additional parties cannot be added to a conference call if an active Whisper Page is on the call.

- Data Privacy — Permanent

Any station that has Data Privacy enabled at the time of activation is not available for a Whisper Page activation.

- Data Privacy — Temporary

Any station that has Data Privacy enabled at the time of activations is not available for a Whisper Page activation.

- Data/Time Terminal Display

See [“Automatic Incoming Call Display” on page 4-636](#).

- Direct Agent Calling Via Logical Agent ID

Whisper Page is not permitted to an Automatic Call Distribution (ACD) agent when the originator of the page uses the Whisper Page activate button followed by Direct Agent calling via Logical Agent ID. Whisper Page may only be permitted to ACD agents if the originator knows the physical extension.
- Direct Department Calling (DDC)

A Whisper Page attempt to an extension defined as a DDC extension is denied, because it is not possible to Whisper Page a group answering environment.
- Distributed Communication System (DCS)

This feature is not a DCS feature.
- Do Not Disturb

Any station user who has Do Not Disturb active on his or her station set is not available for Whisper Page terminations.
- Elapsed Timer

See [“Automatic Incoming Call Display” on page 4-636](#).
- Electronic Tandem Network (ETN)

This feature does not operate in the ETN environment.
- Flexible Language Display

See [“Automatic Incoming Call Display” on page 4-636](#).
- Go to Cover

A Whisper Pager origination is not canceled by pressing the Go to Cover button. Pressing the Go to Cover button while Whisper Page is being activated is ignored. The opposite is true as well. If a user has activated Go to Cover, pressing the Whisper Page activation button does not override the coverage treatment.
- Group Listen

The Group Listening feature, available on the 6400-series terminals, allows a user to use his or her handset for full-duplex communication while having their speakerphone turned on with the microphone muted. When this feature is active, any incoming Whisper Page is heard over both the handset and the speaker.
- Group Paging

See [“Group Listen” on page 4-639](#).
- Hunt Groups

A Whisper Page attempt to an extension defined as any type of hunt group extension is denied, because it is not possible to Whisper Page a group answering environment.

- Last Number Dialed  
Whisper Page activation is tracked as a last number dialed.
- Multilanguage Display  
See [“Automatic Incoming Call Display” on page 4-636](#).
- Priority Calling  
Whisper Page activation against a station that is not busy becomes a nondivertable priority call that is not subject to diversion treatment through any of the Call Forwarding features.
- Privacy — Attendant Lockout  
Whisper Page is denied at those stations in which the user has enabled the Privacy — Attendant Lockout feature.
- QSIG  
This feature does not operate in the QSIG environment.
- Send All Calls  
Whisper Page overrides a station user’s activation of Send All Calls. A Whisper Page activation is similar to a priority call, therefore, it ignores Send All Calls.
- Service Observing — Observe Agents or Non-Agents  
Whisper page is allowed if the paging party has paged the service observer or ACD agent by directly dialing the station extension and not an ACD number or vector directory number (VDN), the paged party must be on a supported set, and both the paging and paged parties must be on the same switch.
- Service Observing — Observe Analog Sets  
In this case, only the service observer can receive a Whisper Page if the observer is on a DCP set. The observed user on the analog set cannot receive a Whisper Page because the system does not allow Whisper Paging to analog sets.
- Service Observing — Observe Digital Sets  
Whisper Page is permitted if the originator of the page has paged the service observer or ACD agent by directly dialing the station extension and not an ACD number or VDN, the paged party is on a supported set, and the paging and paged parties are on the same switch.
- Service Observing — Observe Logical Agents IDs  
A Whisper Page to a Agent Logical ID is denied. A Whisper Page to the service observer is permitted if the service observer has been dialed directly, is on a supported terminal, and both the paging and paged parties are on the same switch.



- Service Observing — Observe Remote By FAC

Whisper Page is permitted if the originator of the page has paged the service observer or ACD agent by directly dialing the station extension and not an ACD number, VDN, or Logical Agent ID; and the paged party must be on a supported set. Both the paging party and the paged party must be local to the switch or the attempt is denied.

- Tenant Partitioning

Whisper Paging is permitted across tenant partitions if the CORs allow for intercom calling between members of different partitions. Attendants who serve multiple partitions make the most use of this feature. It is important for system administrators to make sure that this capability is managed appropriately so that tenants aren't barged-in upon by other tenants that should not have this functionality.

- Terminating Extension Group

Any Whisper Page activation against an extension associated with a Terminating Extension Group is denied because Whisper Page cannot be used in a group answering environment.

- Temporary Bridged Appearances

See [“Bridged Call Appearance” on page 4-637](#).

- Transfer

If a call has an active Whisper Page, the call cannot be transferred.

- Uniform Call Distribution (UCD)

A Whisper Page attempt to an extension defined as a UCD extension is denied, because it is not possible to Whisper Page a group answering environment.

- Voice Terminal Restrictions — Origination

This feature does not allow outbound call originations; therefore, Whisper Page is not allowed.

- Voice Terminal Restrictions — Termination

This feature does not allow inbound calls, therefore Whisper Page is not allowed.

## World-Class Tone Detection

---

World-Class Tone Detection allows DEFINITY ECS to identify and handle different types of call-progress tones. The tone detector and identification is used to display on Data Terminal Dialing and for deciding when to send digits on trunk calls through Abbreviated Dialing, ARS, AAR, and Data Terminal Dialing.

### How to administer World-Class Tone Detection

---

#### Required forms

---

| Form                                 | Field  | Page                  |
|--------------------------------------|--|-----------------------|
| System-Parameters<br>Country-Options | <ul style="list-style-type: none"> <li>■ Tone Detection Mode</li> <li>■ Dial Tone Validation Timer</li> <li>■ Outpulse Without Tone y/n</li> <li>■ Interdigit Pause</li> </ul> | <a href="#">5-271</a> |
| Feature-Related<br>System-Parameters | <ul style="list-style-type: none"> <li>■ Level of Tone Detection</li> <li>■ Off Premises Tone Detection Timeout</li> </ul>   | <a href="#">5-123</a> |

#### NOTE:

The Route Pattern form used with AAR and ARS allows entry of special characters + and! to indicate when to wait for a dial tone. The Abbreviated Dialing form allows entry of ~w and ~W for the same purpose. Configure World-Class Tone Detection to match the characteristics of the dial tone that is to be detected.

### Interactions

---

- Data Modules

Multiline Data Terminal Dialing is disabled if the Multiple-line Level of Tone Detection is **medium** or **broadband**. It is enabled if the Level of Tone Detection is **precise**.

## World-Class Tone Generation

---

World-Class Tone Generation allows you to define call-progress tones. You can select values for frequency and cadence. If you do not define a call-progress tone, DEFINITY ECS sends silence.

### How to administer World-Class Tone Generation

---

#### Required forms

---

| Form              | Field                    | Page                  |
|-------------------|--------------------------|-----------------------|
| System-Parameters | ■ Companding Mode        | <a href="#">5-271</a> |
| Country-Options   | ■ Analog Ringing Cadence |                       |
|                   | ■ Digital Loss Plan      |                       |

---

 **NOTE:**

Brief call-waiting tones are optimal because, while a tone is sounding, speech cannot be heard.



## Basic Forms

# 5

---

This section contains DEFINITY ECS Basic forms.

## Abbreviated Dialing List — Enhanced List

---

This form implements an Enhanced Abbreviated Dialing List. The Enhanced List can consist of ten separate forms numbered from 0 through 9 that allow up to 1000 numbers to be assigned or the Enhanced List can consist of 100 separate forms numbered 0 through 99 that allow up to 10,000 members to be assigned. These two options are discussed below. Regardless of the option you select, the Enhanced List can be accessed by users to place local, long-distance, and international calls; to activate/deactivate features; or to access remote computer equipment.

**⇒ NOTE:**

The Abbreviated Dialing Enhanced List field must be enabled on the System-Parameters Customer-Options form before an Enhanced List can be administered.

Form 0 assigns dial code list entries 000 to 099, form 1—100 to 199, form 2—200 to 299, form 3—300 to 399, form 4—400 to 499, form 5—500 to 599, form 6—600 to 699, form 7—700 to 799, form 8—800 to 899, and form 9—900 to 999 (the form number indicates the first digit of the dial code).

Only one Enhanced Abbreviated Dialing List can be assigned in the system. The list is controlled by the System Administrator.

For attendants with abbreviated dialing, the Console-Parameters form must also be administered.

### Administration commands

---

Use the following commands to administer the Abbreviated Dialing — Enhanced List form.

| Action  | Object                       | Qualifier <sup>1</sup> |
|---------|------------------------------|------------------------|
| add     | abbreviated-dialing enhanced | Enter form number      |
| change  | abbreviated-dialing enhanced | Enter form number      |
| display | abbreviated-dialing enhanced | Enter form number      |
| remove  | abbreviated-dialing enhanced | Enter form number      |

1. If Enhanced Abbreviated Dial Length on the Feature-Related System-Parameters form is set to **3**, enter form number 0 through 9; if the field is set to **4**, enter form number 00 through 99.

## Form instructions

---

Make assignments as required for the following fields on each page of the form. The example screen form shows only form 0.

### Page 1 of the form

Page 1 of 4

ABBREVIATED DIALING LIST  
Enhanced List  
Size (multiple of 5): 5 Privileged? n

DIAL CODE

100: \_\_\_\_\_  
101: \_\_\_\_\_  
102: \_\_\_\_\_  
103: \_\_\_\_\_  
104: \_\_\_\_\_  
105: \_\_\_\_\_

### Screen 5-1. Abbreviated Dialing Enhanced List — form 1 (page 1 of 4)

- **Size (multiple of 5)** — Enter the number of dial code list entries that will be entered on the form. Up to 100 entries per form are allowed. The size must be entered in multiples of 5 up to 100. Default is **5**.
- **Privileged** — Enter **y** or **n** (default). If **y** is entered, the originating party's class of restriction (COR) is never checked and any number in the list will be dialed. If **n** is entered, the COR is checked to determine if the number can be dialed.

## Implementation notes

---

The default value for the `Size` field is **5**. Therefore, only DIAL CODEs 100 through 104 will display initially.

### Pages 1 through 4 of the form

- **DIAL CODE** — Enter the numbers you want to assign to each dial code.



**NOTE:**

A Vector Directory Number extension may also be assigned.

Up to 24 characters can be used for each entry.

Valid entries for each dial code are:

- Digits 0–9
- \* (star) used for a feature activation or deactivation code
- # (pound) used for a feature activation or deactivation code
- Special characters (count as two characters each):
  - ~p (1.5 second pause between digits)
  - ~w (wait for dial tone)
  - ~m (change to output pulse DTMF digits at the end-to-end rate)
  - ~s (start suppressing display of the digits being outputted)
  - ~W (indefinite wait)



**NOTE:**

If W is used, the switch waits indefinitely for dial tone. This should be used only where network response time is more than 30 seconds.



**NOTE:**

While the system is waiting, a call progress tone receiver is tied up, and, since there are a limited number of receivers in the system, outgoing calling capability may be impaired.

See [“Abbreviated Dialing” on page 4-1](#) for a detailed description of the special characters.



## Abbreviated Dialing List — Group List

This form implements the Abbreviated Dialing Group List. The Group Lists are controlled by the System Administrator. Up to 100 numbers can be entered per group list that can be accessed by users to place local, long-distance, and international calls; to activate/deactivate features; or to access remote computer equipment.

### Administration commands

Use the following commands to administer the Abbreviated Dialing Group List form.

| Action  | Object                    | Qualifier <sup>1</sup>  |
|---------|---------------------------|---|
| add     | abbreviated-dialing group | 1-MAX (or 'next')   |
| change  | abbreviated-dialing group | 1-MAX   |
| display | abbreviated-dialing group | 1-MAX ['print' or 'schedule']                                     |
| list    | abbreviated-dialing group | [xx]['number' x]['to-number' x]['count' n]['print' or 'schedule'] |
| remove  | abbreviated-dialing group | 1-MAX   |

1. Brackets [ ] indicate the qualifier is optional. Single quotes ( ' ' ) indicate the text inside the quote must be entered exactly as shown or an abbreviated form of the word may be entered. MAX is the maximum number available in your system configuration.

### Form instructions

Make assignments, as required, for the following fields on each page of the form.

## Page 1 of the form

Page 1 of X

ABBREVIATED DIALING LIST

Group List: \_\_\_\_\_

Size (multiple of 5): 5 Program Ext: \_\_\_\_\_ Privileged? n

DIAL CODE

01: \_\_\_\_\_

02: \_\_\_\_\_

03: \_\_\_\_\_

04: \_\_\_\_\_

05: \_\_\_\_\_

Screen 5-2. Abbreviated Dialing Group List form (page 1 of X)

- **Group List** — Enter a group number when completing a paper form. This is a display-only field when the form is accessed using an administration command such as **add** or **change**.
- **Size (multiple of 5)** — Enter the number of abbreviated dialing codes you want to assign. The number must be entered in multiples of five. Default is 5.
- **Program Ext** — Enter the extension that has permission to program the Group List.
- **Privileged** — Enter **y** or **n** (default). If **y** is entered, the calling voice terminal's class of restriction (COR) is never checked and any number in the group list will be dialed. If **n** is entered, the calling voice terminal's COR is checked to determine if the number can be dialed.

## Implementation notes

The default value for the *Size* field is **5**. Therefore, only DIAL CODEs 01 through 05 will be displayed initially. This form becomes two pages for *Size* field entries of 31 through 60, three pages for entries of 61 through 90, and four pages for entries 91 through 00.

Depending on entry setup on System Parameters — Customer Options, A/D Grp/Sys list dialing start at (01) list items may start at 00 or 01 Abbreviated Dialing List forms: <\$startrange> Group List form.

## Pages 1 through 3 of the form

- **DIAL CODE** — Enter the numbers you want to assign to each dial code.



**NOTE:**

A Vector Directory Number extension may also be assigned.

Up to 24 characters can be used for each entry.

Valid entries for each dial code are:

- Digits 0–9
- \* (star) used for a feature activation or deactivation code
- # (pound) used for a feature activation or deactivation code. # can be the first digit of any FAC.
- Special characters (count as two characters each):
  - ~p (1.5 second pause between digits)
  - ~w (wait for dial tone)
  - ~m (change to outpulse DTMF digits at the end-to-end rate)
  - ~s (start suppressing display of the digits being outpulsed)
  - ~W (indefinite wait)



**NOTE:**

If ~W is used, the switch waits indefinitely for dial tone. This should be used only where network response time is more than 30 seconds.



**NOTE:**

While the system is waiting, a call progress tone receiver is tied up, and, since there are a limited number receivers in the system, outgoing calling capability may be impaired.

## Abbreviated Dialing List — Personal List

---

This form establishes a personal dialing list for voice terminal/data module users. The personal list must first be assigned to the voice terminal by the System Administrator before the voice terminal user can add entries in the list. The lists can be accessed by users to place local, long-distance, and international calls; to activate/deactivate features; or to access remote computer equipment.

### Administration commands

---

Use the following commands to administer the Abbreviated Dialing — Personal List form.

| Action  | Object                       | Qualifier <sup>1</sup>  |
|---------|------------------------------|---|
| change  | abbreviated-dialing personal | xxxx (extension number of assigned personal list) and List 1-3                            |
| display | abbreviated-dialing personal | xxxx (extension number of assigned personal list) and List 1-3<br>['print' or 'schedule'] |
| list    | abbreviated-dialing personal | [xxxx (extension)]['ext' x]['to-ext' x]['count' n] ['print' or 'schedule']                |

1. Brackets [] indicate the qualifier is optional. Single quotes ( ' ') indicate the text inside the quote must be entered exactly as shown or an abbreviated form of the word may be entered. MAX is the maximum number available in your system configuration.

## Form instructions

---

Page 1 of 4

ABBREVIATED DIALING LIST

Personal List: \_\_\_\_\_ List Number: \_\_\_\_  
Size (multiple of 5): 5

DIAL CODE

01: \_\_\_\_\_  
02: \_\_\_\_\_  
03: \_\_\_\_\_  
04: \_\_\_\_\_  
05: \_\_\_\_\_  
06: \_\_\_\_\_  
07: \_\_\_\_\_  
08: \_\_\_\_\_  
09: \_\_\_\_\_  
00: \_\_\_\_\_

Screen 5-3. Abbreviated Dialing Personal List form (page 1 of 1)

Make assignments, as required, for the following fields on the form.

- **Personal List** — Enter the extension number of the voice terminal that will use this list.
- **List Number** — Enter a number from 1 to 3. This number identifies each of the three personal lists that can be assigned to the voice terminal.
- **Size (multiple of 5)** — Enter the number of abbreviated dialing numbers to be assigned. This number must be entered in multiples of 5, up to 100. Default is 5.
- **DIAL CODE** — Enter the numbers you want to assign to each dial code.



**NOTE:**

A Vector Directory Number extension may also be assigned.

Up to 24 characters can be used for each entry.

Valid entries for each dial code are:

- Digits 0–9
- \* (star) used for a feature activation or deactivation code
- # (pound) used for a feature activation or deactivation code
- Special characters (count as two characters each):
  - ~p (1.5 second pause between digits)
  - ~w (wait for dial tone)
  - ~m (change to outpulse DTMF digits at the end-to-end rate)

5 Basic Forms

*Abbreviated Dialing List — Personal List*

Page 5-10

~s (start suppressing display of the digits being outpulsed)

~W (indefinite wait)

 **NOTE:**

If ~W is used, the switch waits indefinitely for dial tone. This should be used only where network response time is more than 30 seconds.

 **NOTE:**

While the system is waiting, a call progress tone receiver is tied up, and, since there are a limited number of receivers in the system, outgoing calling capability may be impaired.

### Implementation note

---

The default value for `Size` is **5**. Therefore, only DIAL CODEs 1 through 5 will be displayed initially. DIAL CODEs 6 through 0 will also be displayed if the `Size` field is "10". DEFINITY ECS allows up to 100 DIAL CODEs.

Depending on entry setup on System Parameters — Customer Options, A/D Grp/Sys list dialing start at (01) list items may start at 00 or 01.

## Abbreviated Dialing List — System List

---

This form implements a system abbreviated dialing list. Only one system list can be assigned and is administered by the System Administrator. The list can be accessed by users to place local, long-distance, and international calls; to activate/deactivate features; or to access remote computer equipment.

### Administration commands

---

Use the following commands to administer the Abbreviated Dialing System List form.

| Action  | Object                     | Qualifier <sup>1</sup>  |
|---------|----------------------------|-------------------------|
| add     | abbreviated-dialing system | —                       |
| change  | abbreviated-dialing system | —                       |
| display | abbreviated-dialing system | ['print' or 'schedule'] |
| remove  | abbreviated-dialing system | —                       |

- 
1. Brackets [] indicate the qualifier is optional.

### Form instructions

---

Make assignments, as required, for the following fields on each page of the form.

## Page 1 of 4 of the form

Page 1 of X

ABBREVIATED DIALING LIST  
System List

| DIAL CODE | Size (multiple of 5): 5 | Privileged? n |
|-----------|-------------------------|---------------|
| 01:       | _____                   |               |
| 02:       | _____                   |               |
| 03:       | _____                   |               |
| 04:       | _____                   |               |
| 05:       | _____                   |               |
| 06:       | _____                   |               |
| 07:       | _____                   |               |
| 08:       | _____                   |               |
| 09:       | _____                   |               |
| 10:       | _____                   |               |
| 11:       | _____                   |               |
| 12:       | _____                   |               |
| 13:       | _____                   |               |
| 14:       | _____                   |               |
| 15:       | _____                   |               |

### Screen 5-4. Abbreviated Dialing System List form (page 1 of X)

- **Size (multiple of 5)** — Enter the number of abbreviated dialing numbers to be assigned. This number must be entered in multiples of 5, up to 100. Default is 5.
- **Privileged** — Enter **y** if the originating party's class of restriction (COR) is never checked and any number in the list can be dialed. Enter **n** (default) if the COR is to be checked to determine if the number can be dialed.

### Pages 1 through 3 of the form

- **DIAL CODE** — Enter the numbers you want to assign to each dial code.



#### NOTE:

A Vector Directory Number extension may also be assigned.

Up to 36 characters can be used for each entry.

Valid entries for each dial code are:

- Digits 0–9
- \* (star) used for a feature activation or deactivation code
- # (pound) used for a feature activation or deactivation code
- Special characters (count as two characters each):
  - ~p (1.5 second pause between digits)
  - ~w (wait for dial tone)



5 Basic Forms

*Abbreviated Dialing List — System List*

Page 5-13

~m (change to outpulse DTMF digits at the end-to-end rate)

~s (start suppressing display of the digits being outpulsed)

~W (indefinite wait)

 **NOTE:**

If ~W is used, the switch waits indefinitely for dial tone. This should be used only where network response time is more than 30 seconds.

 **NOTE:**

While the system is waiting, a call progress tone receiver is tied up, and, since there are a limited number of receivers in the system, outgoing calling capability may be impaired.

Depending on entry setup on System Parameters — Customer Options, A/D Grp/Sys list dialing start at (01) list items may start at 00 or 01.

## Implementation notes

---

The default value for the *Size* field is **5**. Therefore, only DIAL CODEs 01 through 05 will be displayed initially. This form becomes two pages for *Size* field entries of 31 through 60, three pages for entries of 61 through 90, and four pages for entries 91 through 00.

## Abbreviated Dialing List — 7103A Button List

---

This form assigns abbreviated dialing numbers to the 7103A voice terminal buttons. The entries can then be accessed by 7103A voice terminal users to place local, long-distance, and international calls; activate/deactivate features; or to access remote computer equipment. This form applies only to 7103A fixed feature voice terminals. Only one 7103A abbreviated dialing list can be implemented in the system and it applies to all 7103A fixed feature voice terminals in the system. This list is controlled by the System Administrator.

### Administration commands

---

Use the following commands to administer the Abbreviated Dialing — 7103A List form.

| Action  | Object                            | Qualifier               |
|---------|-----------------------------------|-------------------------|
| add     | abbreviated-dialing 7103A-buttons | —                       |
| change  | abbreviated-dialing 7103A-buttons | —                       |
| display | abbreviated-dialing 7103A-buttons | ['print' or 'schedule'] |
| remove  | abbreviated-dialing 7103A-buttons | —                       |

### Form instructions

---

Make assignments, as required, for the following fields on each page of the form.

(In the following, the dial code numbers 1 through 8 as shown on the form relate to the buttons on the 7103A voice terminal.)

## Pages 1 through 4 of the form

Page 1 of 1

ABBREVIATED DIALING LIST  
7103A Button List

DIAL CODE (FOR THE 7103A STATION BUTTONS)

|          |          |
|----------|----------|
| 1: _____ | 5. _____ |
| 2: _____ | 6. _____ |
| 3: _____ | 7. _____ |
| 4: _____ | 8. _____ |

### Screen 5-5. Abbreviated Dialing List — 7103A Button List

- **DIAL CODE FOR THE 7103a STATION BUTTONS** — Enter the number you want to assign to each dial code (button). Any additions or changes apply to all 7103A fixed feature voice terminals.



**NOTE:**

A Vector Directory Number extension may also be assigned.

Up to 24 characters can be used for each entry.

Valid entries for each dial code are:

- Digits 0–9
- \* (star) used for a feature activation or deactivation code
- # (pound) used for a feature activation or deactivation code
- Special characters (count as two characters each):
  - ~p (pause)
  - ~w (wait)
  - ~m (mark)
  - ~s (suppress)
  - ~W (indefinite wait)



**NOTE:**

If ~W is used, the switch waits indefinitely for dial tone. This should be used only where network response time is more than 30 seconds.

While the system is waiting, a call progress tone receiver is tied up, and, since there are only two receivers per tone decoder, outgoing calling capability may be impaired.

## **Implementation**

---

The default value for the `Size` field is **5**. Therefore, only DIAL CODEs 01 through 05 will be displayed initially. This form becomes two pages for `Size` field entries of 31 through 60, three pages for entries of 61 through 90, and four pages for entries 91 through 00.

Depending on entry setup on System Parameters — Customer Options, A/D Grp/Sys list dialing start at (01) list items may start at 00 or 01.

## Administered Connection

---

This form assigns an end-to-end Administered Connection (AC) between two access endpoints or data endpoints. The AC is established automatically by the system whenever the system restarts or the AC is due to be active. See [“Administered Connections” on page 4-13](#) and [“Access Endpoint” on page 7-72](#) in this book for additional information.

### Administration commands

---

Use the following commands to administer the Administered Connection form.

| Action    | Object                  | Qualifier <sup>1</sup>                        |
|-----------|-------------------------|---|
| add       | administered-connection | 1-MAX (or 'next')                             |
| change    | administered-connection | 1-MAX (or 'next')                             |
| display   | administered-connection | 1-MAX (or 'next') ['print' or 'schedule']     |
| duplicate | administered-connection | 1-MAX (or 'next')                             |
| remove    | administered-connection | 1-MAX (or 'next')                             |
| list      | administered-connection | 1-MAX ['count' 1-MAX] ['print' or 'schedule'] |

- 
1. Brackets [ ] indicate the qualifier is optional. Single quotes ( ' ' ) indicate the text inside the quote must be entered exactly as shown or an abbreviated form of the word may be entered. MAX is the maximum number available in your system configuration.

## Form instructions

---

```

                                                                 Page 1 of 1
                ADMINISTERED CONNECTION
Connection Number: 1                                     Enable? y
  Originator: _____
  Destination: _____
      Name: _____
AUTHORIZED TIME OF DAY
  Continuous? n
    Sun? n Mon? n Tue? n Wed? n Thu? n Fri? n Sat? n
  Start Time: 00:00
    Duration: 000:00
MISENTRYANEOUS PARAMETERS
  Alarm Type: warning                                   Alarm Threshold: 5
  Retry Interval: 2                                     Auto Restoration? y
    Priority: 5
```

### Screen 5-6. Administered Connection form (page 1 of 1)

Make assignments as required for the following fields on the form:

- **Connection Number** — This is a display-only field when the form is accessed using an administration command such as **change** or **display**. Enter an unassigned AC number.
- **Enable** — Enter **y** (default) to indicate an attempt will be made to establish the AC when the AC is due to be active.
- **Originator** — Enter the assigned extension of the originating access endpoint or data endpoint. The endpoint must be local to the switch on which the AC is administered. Endpoints may be:
  - Nonsignaling DS1 trunk or analog tie trunk
  - TN726 data line circuit pack
    - Asynchronous EIA 232C compatible equipment
  - TN754 digital line circuit pack connections, including:
    - MPDM (700D), MTDM (700B, 700C, 700E), 7400D data module
    - 7400A, 7400B, 7400C HSL, 8400B data module
    - 7401D Voice Terminal with 7400B or 8400B data module
    - 7403D/7405D/7407D/7410D/7434D voice terminal with DTDM or 7400B or 8400B data module
    - 7404D or 7406D voice terminal
    - 510D personal terminal

- 515 BCT, 615 BCT, or 715 BCT terminal
- PC/PBX connection
- TN556 ISDN-BRI line circuit pack connections, including:
  - 7500 data module
  - 7505D/7506D/7507D voice terminal with ADM

Default is blank.

- **Destination** — Used to route the AC to a desired endpoint. Enter the address of the destination access or data endpoint. This endpoint is the terminating party of the AC and need not be local to the switch on which the AC is assigned. Valid entries are the digits 0 through 9, \*, #, and special characters ~**m** (mark), ~**s** (suppress), ~**p** (pause), ~**w** (wait), ~**W** (indefinite wait). The entry must be consistent with the local switch's dial plan (that is, the first digits are assigned as an extension, feature access code, or trunk access code, or DDD Number). If a local extension is entered, it must be assigned to either an access or data endpoint. Up to 36 characters may be entered. Special characters count as two characters. Abbreviated Dialing entries may be used in this field. Default is blank.

 **NOTE:**

If ~W is used, the switch waits indefinitely for dial tone. This should be used only where network response time is more than 30 seconds.

While the system waits, a call progress tone receiver is tied up, and, since there are only two receivers per tone decoder, outgoing calling capability may be impaired.

- **Name** — Enter a short identification of the AC. This entry is optional. Up to 27 printable alphanumeric characters may be entered. Default is blank.
- **Continuous** — Enter **y** (default) to indicate that the AC is continuous (that is, not scheduled to be active at a certain time). If **y** is entered, the seven *Start Days* and associated *Duration* fields are not displayed.
- **Start Days (Sun through Sat)** — Only displays if the *Continuous* field is **n**. Enter **y** in each of the required days of the week fields to indicate that an attempt will be made to establish the AC. Default is **n**.

 **NOTE:**

These fields indicate only the days on which an attempt will be made to establish the AC and not necessarily the days on which the AC is active. A scheduled AC may be active over a number of days, and, in this situation, these fields should be used only to specify the days on which the AC starts and not other days on which the AC may be active.

- **Start Time** — Only displays if the **Continuous** field is **n**. Enter the time of the day when an attempt should begin to establish a scheduled AC. The time is specified in two fields separated by a colon. Valid entries are in the range **00:00** through **23:59**. Default is **00:00**.
- **Duration** — Only displays if the **Continuous** field is **n**. Enter the period of time that the scheduled AC should remain active. This period is specified in two fields separated by a colon. The maximum duration is 167 hours and 59 minutes (that is, 1 minute less than 1 week). Valid entries are **000** through **167** for the hour field and **00** through **59** for the minute field. Default is **000:00**.
- **Alarm Type** — Enter the type of alarm to be generated if the AC cannot be initially established, or fails and cannot be reestablished, and the number of consecutive failures equals the alarm threshold. The alarm notification may be disabled for this AC by entering **none** in this field. Valid entries are **major**, **minor**, **warning** (default), or **none**.

 **NOTE:**

All AC alarms and the errors that caused the alarms are recorded in the system's alarm and error log. In addition, a status lamp associated with an attendant console or voice terminal feature button (ac-alarm) may be used to indicate the AC alarm.

- **Alarm Threshold** — Only displays if an entry of other than **none** is entered in the **Alarm Type** field. Enter the number of times an attempt to establish or reestablish an AC must fail consecutively before an AC alarm generates. An alarm generates on the first failure if **1** is entered in this field. Valid entries are **1** through **10**. Default is **5** (an alarm will be generated after the fourth retry has failed, thus, with the default retry interval of 2 minutes, an alarm will be generated approximately 8 minutes after the first failure occurs).
- **Retry Interval** — Enter the number of minutes between attempts to establish or reestablish the AC. Valid entries are **1** through **60**. Default is **2**.
- **Auto Restoration** — Enter **y** to indicate that an attempt is to be made to reestablish an AC that failed. Auto Restoration is available only for an AC that is established over an ISDN Software Defined Data Network (SDDN) trunk group. A **y** (default) entered in this field is ignored in all other situations.
- **Priority** — Enter a number in the range from **1** through **8** that is to be used to determine the order in which ACs are to be established (1 is the highest and 8 the lowest priority). Default is **5**.



## Alias Station

---

This form administers new voice terminal types not supported by system software. This form allows the mapping of new terminal types to the supported terminal types. This mapping does not guarantee compatibility, but allows nonsupported terminals to be administered and tracked by their own names.

System administration must refer to customer voice terminal documentation for supported types and associated manuals for non-supported types to avoid type mismatches between the new terminal and the supported terminal.

### NOTE:

Data Communication Protocol (DCP) terminal types must be mapped (aliased) to DCP terminal types, hybrid types to hybrid types, and analog to analog types.

See [“Enhanced Voice Terminal Display” on page 4-322](#) in this book for additional information.

## Administration commands

---

Use the following commands to administer the Alias Station form.

| Action  | Object        | Qualifier <sup>1</sup>  |
|---------|---------------|-------------------------|
| change  | alias station | —                       |
| display | alias station | ['print' or 'schedule'] |

---

1. Brackets [ ] indicate the qualifier is optional.

## Form instructions

---

Page 1 of 1

| ALIAS STATION  |                    |
|----------------|--------------------|
| Alias Set Type | Supported Set Type |
| _____          | _____              |
| _____          | _____              |
| _____          | _____              |
| _____          | _____              |
| _____          | _____              |
| _____          | _____              |
| _____          | _____              |
| _____          | _____              |
| _____          | _____              |
| _____          | _____              |

'#' indicates previously aliased set type is now native

### Screen 5-7. Alias Station form (page 1 of 1)

Make assignments as required for the following fields on the form:

- **Alias Set Type** — Enter the nonsupported voice terminal type to be aliased to a similar supported voice terminal type. Up to six characters (all printable characters except blank characters) are allowed.



**NOTE:**

A duplicate nonsupported type entry is not allowed on the form (that is, SET20 and Set20 are considered as duplicates).

- **Supported Set Type** — Enter the supported voice terminal type to be mapped or aliased to the nonsupported type entered immediately to the left in *Alias Set Type*. Up to five characters (all printable characters except blank characters) are allowed. Supported voice terminal types are summarized in [“Voice terminals — general” on page 6-4](#).

## Implementation notes

---

When a system containing an alias set type is upgraded to a new release that supports the previously aliased set type as a native set type, the last character of the aliased set type appends a “#.” This indicates that it is no longer necessary to alias the set type to another supported type. If the set type takes up all six characters, the “#” replaces the last character.

It is recommended (though not required) that stations using the alias set type be changed to use the newly supported set type, and the alias set type be removed from the Alias Station form.

## Alphanumeric Dialing Table

---

This form associates alpha-names to dialed digit strings. This allows terminal users to place a *data call* by simply typing the alpha-name. Users need only remember far-end alpha-names instead of the actual digit strings.

The form consists of paired Alpha-name/Mapped String fields. Entries may be made in any order on the form. However, before the form is displayed for changing or reviewing, the entries in the table are sorted alphanumerically by the alpha-name. All entries will be moved to the beginning of the table, leaving all blank entries at the end.

### Administration commands

---

Use the following commands to administer the Alphanumeric Dialing Table form.

| Action  | Object                  | Qualifier <sup>1</sup> |
|---------|-------------------------|------------------------|
| change  | alphanumeric-dial-table | —                      |
| display | alphanumeric-dial-table | [print]                |

---

1. Brackets [ ] indicate the qualifier is optional.

### Form instructions

Page 1 of 2

ALPHANUMERIC DIALING TABLE

XXX of XXX administered

| Alpha-name | Mapped String | Alpha-name | Mapped String |
|------------|---------------|------------|---------------|
| _____      | _____         | _____      | _____         |
| _____      | _____         | _____      | _____         |
| _____      | _____         | _____      | _____         |
| _____      | _____         | _____      | _____         |
| _____      | _____         | _____      | _____         |
| _____      | _____         | _____      | _____         |
| _____      | _____         | _____      | _____         |
| _____      | _____         | _____      | _____         |
| _____      | _____         | _____      | _____         |
| _____      | _____         | _____      | _____         |
| _____      | _____         | _____      | _____         |
| _____      | _____         | _____      | _____         |
| _____      | _____         | _____      | _____         |
| _____      | _____         | _____      | _____         |
| _____      | _____         | _____      | _____         |
| _____      | _____         | _____      | _____         |
| _____      | _____         | _____      | _____         |
| _____      | _____         | _____      | _____         |
| _____      | _____         | _____      | _____         |
| _____      | _____         | _____      | _____         |
| _____      | _____         | _____      | _____         |
| _____      | _____         | _____      | _____         |

Screen 5-8. Alphanumeric Dialing form (page 1 of 2)

Make assignments as required for the following fields on the form:

- **Alpha-name** — Enter from one to eight alphanumeric characters. The entry must start with an alphabetic character and may not have blank spaces between characters. All alpha-names in the table must be unique and cannot be referenced in their own "Mapped String". The alpha-names can be used in any other "Mapped String" and multiple times in a "Mapped String". Default is blank.
- **Mapped String** — Enter from 1 to 24 characters that may contain alphanumeric, readability, delimiters, and/or special characters. The entry is used to generate the final dialing string and can include Facility Access Codes. The following characters are allowed:

**Numeric** — Digits **0** through **9**.

**Alpha** — **A** through **Z**, **a** through **z** (note uppercase entries are mapped to lowercase).

**Readability** — Character delimiters used for easy reading of the dial string. The characters are "(", ")", "/", "-", and the space character.

 **NOTE:**

A Mapped String may not contain an Alpha-Name whose Mapped String also contains an Alpha-Name.

- **Special Characters** — Used to identify a special operation. The characters are:

"#" and "\*" — Each treated as a numeric.

"^" — Treated as a readability character.

"~w" — Suspend digit outputting until a dial tone is detected.

"~p" — Pause 1.5 seconds. (Used only for outgoing trunk calls. If used internally, the 1.5 second pause is ignored.)

"~m" — Digits following this character are for end-to-end signaling. Following digits to be outputted as tones regardless of type of trunk signaling, pulse, or tone.

Delimiters can consist of both readability and special characters and are used to separate tokens of "alpha-names" or numeric sub-strings. For example, "(205) mt-1234+0000".

## Announcements/Audio Sources

---

This form assigns analog, DS1, auxiliary trunk, or integrated announcements, audio/music sources, or any desired combination of announcements and audio sources. Integrated announcements are assigned and recorded on all TN750A, B, and C announcement circuit packs.

The analog announcements are assigned to analog line circuit packs, such as TN746 or TN2183, that are connected to external recording or playback equipment. External announcement equipment can also be connected via an auxiliary trunk (TN763). DS1 announcements are assigned to DS1 ports on circuit packs, such as TN767 or TN464.

Each announcement is accessed by dialing an extension number that is assigned to each announcement.

Integrated announcements on the TN750B and TN750C circuit packs can be recorded at 16 kbps (for 8 minutes and 32 seconds of total announcement time), 32 kbps (for 4 minutes and 16 seconds of total announcement time), or 64 kbps (for 2 minutes and 8 seconds of total announcement time) depending on administration. A different recording speed may be used for each integrated announcement. These capacities are different if a combination of different recording speeds is used.

A R5r and later configurations support a maximum of 10 integrated announcement circuit packs (TN750Cs). At 16 kbps this provides 5120 seconds (1 hour and 24 minutes) of announcement time. At 32 kbps this provides 2560 seconds (42 minutes) of announcement time.

### CAUTION:

*Do not copy, save, or restore announcements from a TN750C to a TN750 or TN750B, as it may corrupt the announcement data.*

## Copy Announcements

---

Copy announcements is used to copy MSS announcement files from disk to tape or tape to disk.

The TN750C circuit pack contains FLASH memory which provides internal backup of announcements on the circuit packs. Thus, the TN750C circuit pack does not need the Save and Restore processes still available for the TN750 and TN750B circuit packs. However, you can use the save and restore processes to copy announcements between TN750B/C circuit packs. See [Appendix B, "Administration Commands"](#) for information on the save announcement and restore announcement commands.

## Save Announcements

Save Announcements is used to save announcements from the announcement circuit pack to MSS.

## Restore Announcements

Restore Announcements is used to restore announcements from MSS to the announcement circuit pack.

## Erase Announcements

You can erase the existing announcements stored on a TN750C circuit pack's FLASH and DRAM memory by executing the erase announcements command. You must supply the circuit pack location of the circuit pack as part of the command argument. When you execute a valid erase announcements command, you will see a warning message:

### **WARNING:**

*This erase announcement command will erase the specified circuit packs flash and DRAM memory.*

If you respond by pressing the enter key, the announcement circuit pack is erased. If you respond by pressing the cancel key, the announcement circuit pack is not erased. The erase command outputs the status (busy, success, etc.) of the flash memory after executing the erase command.

## Remove Announcement

Use the change announcements command to remove an existing announcement. You need only blank out the extension and type fields of the existing entry. The integrated announcement will be removed from the integrated announcement circuit pack; it will not be removed from the backup tape or disk. Use the delete announcement FAC before you change announcements. Otherwise, the recording time used by the announcement will not be made available.

## Administration commands

Use the following administration commands to administer the recorded announcements form. In some cases, just the most commonly used commands are shown. See [Appendix B, "Administration Commands"](#), for a complete listing of all administration commands, the command structure, and the use of abbreviated command words when entering a command.

5 Basic Forms

Announcements/Audio Sources

| Action  | Object                 | Qualifier <sup>1</sup>   |
|---------|------------------------|--|
| change  | announcements          | —  |
| change  | integ-annc-brd-loc     |  |
| display | announcements          | ['print' or 'schedule']  |
| display | integrated-annc-boards | ['print' or 'schedule']  |
| erase   | announcements          | board-location   |
| list    | integrated-annc-boards | board-location<br>['print' or 'schedule']<br>This qualifier is optional. |
| copy    | announcements          | 2  |
| restore | announcements          | <u>2</u>   |
| save    | announcements          | <u>2</u>   |

- 
1. Brackets [ ] indicate the qualifier is optional.
  2. See [Appendix B, "Administration Commands"](#) in this manual for more information.
- 

## Form instructions

Make assignments as required for the following fields on the form:



5 Basic Forms

Announcements/Audio Sources

Pages 1 through 8 of the form

| ANNOUNCEMENTS/AUDIO SOURCES |            |     |    |                |   |      |     |      |        |
|-----------------------------|------------|-----|----|----------------|---|------|-----|------|--------|
| Ext.                        | Type       | COR | TN | Name           | Q | QLen | Pro | Rate | Port   |
| 1: 1701_                    | analog     | 1_  | 1_ | busy           | y | 1000 | N/A | N/A  | 1B0404 |
| 2: 1702_                    | analog     | 1_  | 1_ | out of service |   | N/A  | N/A | N/A  | 1B1701 |
| 3: 1703_                    | integrated | 1_  | 1_ | please dial    | n | N/A  | n   | 32   | 1B18   |
| 4: 1704_                    | aux-trunk  | 1_  | 1_ | call-back      | y | 20   | N/A | N/A  | 2C0902 |
| 5: _____                    | _____      | 1_  | 1_ | _____          | n |      |     |      |        |
| 6: _____                    | _____      | 1_  | 1_ | _____          | n |      |     |      |        |
| 7: _____                    | _____      | 1_  | 1_ | _____          | n |      |     |      |        |
| 8: _____                    | _____      | 1_  | 1_ | _____          | n |      |     |      |        |
| 9: _____                    | _____      | 1_  | 1_ | _____          | n |      |     |      |        |
| 10: _____                   | _____      | 1_  | 1_ | _____          | n |      |     |      |        |
| 11: _____                   | _____      | 1_  | 1_ | _____          | n |      |     |      |        |
| 12: _____                   | _____      | 1_  | 1_ | _____          | n |      |     |      |        |
| 13: _____                   | _____      | 1_  | 1_ | _____          | n |      |     |      |        |
| 14: _____                   | _____      | 1_  | 1_ | _____          | n |      |     |      |        |
| 15: _____                   | _____      | 1_  | 1_ | _____          | n |      |     |      |        |
| 16: _____                   | _____      | 1_  | 1_ | _____          | n |      |     |      |        |

Screen 5-9. Recorded Announcements form (page 1 of X)

- **Ext** — Enter a 1- to 5-digit unassigned extension number that agrees with the dial plan. References to a particular announcement "Ext" may be from the following forms: Hunt Group, Coverage Path, Trunk Group (Incoming Destination and Night Destination), Vector, and Feature-Related System Parameters (DID/Tie/ISDN Intercept Treatment, Controlled Restriction fields).
- **Type** — Enter the type of announcement you want to assign to this extension number. Valid entries are **analog-m**, **analog**, **analog-fd**, **aux-trunk** (auxiliary trunk, for using external announcement device with a 4-wire "aux" interface), **aux-trk-m**, **ds1-fd**, **ds1-ops**, **ds1-sa**, **integ-rep** (integrated repeating), and **integrated**.

If **integrated** or **integ-rep** is entered, complete the **Protect**, **Rate**, and **Port** fields. If **analog**, **ds1-fd**, **ds1-sa**, **ds1-ops**, or **aux-trunk** is entered, complete the **QLen** (if **Q** is **y**) and **Port** fields.

Integrated announcements have a pre-set queue length (used over all installed circuit packs) based on the DEFINITY ECS configuration, but the **Q** field must be **y** if you want to enable queueing.

- **COR** — Enter the desired class of restriction (COR) number from **0** through **95**. Default is **1**.
- **TN** — Enter the Tenant Partition number. Default is **1**.
- **Name** — Enter up to 27 alphanumeric characters to describe the announcement message.

- **Q (Queue)** — Enter **y** in this queue field to queue calls for the announcement. If the type is either **integ-rep** or **aux-trunk**, enter **y** to queue calls or **b** to enable barge-in. Default is **n** (no queue and no barge-in). You can enter **b** only if **Type** is **aux-trunk** or **integrated**. This field should always be **y** for ACD and Vectoring delay announcements. The **QLen** (Queue Length) field only applies if **y** is entered in this field with analog, DS1, and aux types.
- **QLen (Queue Length)** — Applicable if the **Q** (Queue) field is **y** and the **Type** field is **analog** or **aux-trunk**. Enter the number of calls that can be queued for this analog announcement. The sum of the queue entries for all analog announcements cannot exceed the maximum number allowed for your system configuration. Default is **0**. When the **Type** field entry is **integrated** or **integ-rep**, “N/A” displays in this field.
- **Pro** — Enter **y** to protect the integrated announcement from being deleted or changed by any user. Enter “**n**” (default) to allow only users with a console permission COS to change or delete an announcement. When the **Type** field is **analog**, **ds1**, or **aux-trunk**, then “N/A” displays in this field.
- **Rate** — Used to specify the recording speed (in 1000 bits/second) when recording announcements on the TN750B or TN750C Integrated circuit pack. Valid entries are **16**, **32** (default), or **64**. When the **Type** field is **analog**, **ds1**, or **aux-trunk**, then “N/A” displays in this field.
- **Port** — You can enter an integrated announcement circuit pack location in this field or an aux trunk, analog line, or DS1 port location (a station/single line voice terminal form is not to be administered). When a port location is changed for an integrated announcement, the recording on the previous circuit pack location is erased. To change the port locations for all announcement extensions assigned to a circuit pack location to another circuit pack location without erasing the announcements on the original circuit pack, change the Integrated Announcement Translations form.

An integrated announcement circuit pack location breaks down as follows:

| Characters | Meaning        | Value         |
|------------|----------------|---------------|
| 1-2        | Cabinet Number | 01 through 44 |
|            |                | 01 through 03 |
|            |                | 01 (G3s)      |
| 3          | Carrier        | A through E   |
| 4-5        | Slot Number    | 01 through 20 |

An aux or analog location breaks down as follows:

| Characters | Meaning        | Value  |
|------------|----------------|--|
| 1-2        | Cabinet Number | 01 through 44                                      |
|            |                | 01 through 03                                      |
|            |                | 01 (G3s)   |
| 3          | Carrier        | A through E  |
| 4-5        | Slot Number    | 01 through 20                                      |
| 6-7        | Circuit Number | 01 through 16 (analog)<br>01 through 04 aux-trunk) |

## Implementation notes

Announcements 1 and 3 show the fields that are assigned to the analog and integrated announcement, respectively.

The `QLen` field only displays when the `Type` field is **analog**, **ds1**, or **aux-trunk** and the `Queue` field is **y**.

The `Prot` field only displays when the `Type` field is **integrated**.

Only one TN750 or TN750B circuit pack is allowed per system. You can use TN750C circuit packs exclusively or use one TN750B with multiple TN750C circuit packs.

INTEGRATED ANNOUNCEMENT BOARDS

Last Board Location Saved 02C09 on 07/24/94 0:30 am

| Board<br>Loc. | Sfx | Time Remaining<br>at 32Kbps | Number of<br>Recordings | Checksum ID |
|---------------|-----|-----------------------------|-------------------------|-------------|
| 1: 01B04      | B   | 30                          | 25                      |             |
| 2: 01B05      | C   | 256                         | 0                       | 0000        |
| 3: 02C09      | C   | 65                          | 15                      | 0015        |
| 4: 02C11      | C   | 95                          | 45                      | 00A8        |
| 5:            |     |                             |                         |             |
| 6:            |     |                             |                         |             |
| 7:            |     |                             |                         |             |
| 8:            |     |                             |                         |             |
| 9:            |     |                             |                         |             |
| 10:           |     |                             |                         |             |

Screen 5-10. Example Display Integrated Announcement Boards

- The number of lines displayed corresponds to the number of announcement circuit packs plugged in with the maximum dictated by the system maximum.
- Time Remaining displays the time, in seconds, that can be recorded in the remaining memory at 32 Kbps. Length in Seconds displays the amount of time that the recording would take at 32 Kbp. It does not convert the length to reflect the actual length if the recording was at 16 or 64 Kbps. The sum of the Length in Seconds and Time Remaining fields is always 256 seconds.
- Number of Recordings is the count of non-zero length recordings on the circuit pack.
- Checksum ID is a four character hexadecimal value (the first two characters are always 00) returned from the TN750C circuit pack. The checksum is calculated from the announcements stored on the circuit pack. The circuit pack internally updates this value every time an announcement is recorded or deleted. The checksum is 0000 when nothing is recorded on the circuit pack. Circuit packs other than the TN750C do not provide the Checksum ID and will display a blank in the Checksum ID column.
- The date, time, and location of the announcement circuit pack most recently saved on MSS displays after the "Last Board Location Saved" heading. This date is part of the translation data so you must run "save translations" to retain the date. These fields are set to N/A if a circuit pack has not been saved using the save announcement command or the save translations were not run before rebooting. The information here may not be the same time as displayed on "list config software". (If the time is not

the same, the announcements for a TN750 or TN750B should be saved again.) "List config software" presents the date of the announcement saved on MSS.

- The **List Config** command reports the date on which the save announcement was last executed successfully. It is the date for MSS announcements; not translation data.
- The Display Integrated command reports the date on which the save announcement was last executed successfully. It is translation data and will be lost if you do not run save translations.

```

Page 1 of X

INTEGRATED ANNOUNCEMENTS

Board Location: 01B04                               Time Remaining at 32Kbps: 25

Internal      Announcement
Number        Extension    Name          Rate          Length in
              Ext #       (Name)        (Kbps)        Seconds
-----
1             Ext #       (Name)        16            3
2             16003      sales ad      32            18
3             15003      sales 1st delay 32            210
4             15005      sales 2nd delay 64            0
    
```

Screen 5-11. Example List Integrated Announcements (page 1 of X)

- The **List Integrated Announcements** command provides information on all integrated announcement circuit packs (default) or only a selected circuit pack. Use this command to verify announcement extension assignments.
- If a circuit pack does not have announcements on it and does not have announcements administered on it, then no information about the circuit pack will be presented with the list command.
- Announcements that are recorded on the circuit pack, but which are not assigned to an extension, are displayed without an extension and name. You can see this in the first line of the example.
- An R5r and later configuration can list a maximum of 256 announcements. An R5si and later can list a maximum of 128.
- `Internal Number` is the internal announcement number referring to a specific announcement on the circuit pack that you requested. It does not correspond to the reference number that is displayed on the Announcement form.

5 Basic Forms

Announcements/Audio Sources

Page 5-34

- `Announcement Extension` is the extension that was mapped to the internal number when the extension was administered on the Announcement form.
- `Name` is the name administered on the Announcement form.
- `Rate` is administered on the Announcement form.
- `Length in Seconds` is the length of the announcement at 32 kbps at the circuit pack location pointed to by the internal number.
- `Time Remaining` displays the time, in seconds, that can be recorded in the remaining memory at 32 kbps. Double this time for recording at 16 kbps or halve the time for recording a 64 kbps.

CHANGE INTEGRATED ANNOUNCEMENT TRANSLATIONS

Change all board location translations from board: \_\_\_\_\_ to: \_\_\_\_\_

Changing board locations using this command will change all currently administered "from" board locations on the "ANNOUNCEMENTS/AUDIO SOURCES" screen to the "to" board location.

Screen 5-12. Change Integrated Announcement Translations form

## Attendant Console

This form assigns an Attendant Console to the system.

### Administration commands

Use the following commands to administer the Attendant Console form.

| Action  | Object    | Qualifier <sup>1</sup>        |
|---------|-----------|-------------------------------|
| add     | attendant | 1-MAX                         |
| change  | attendant | 1-MAX                         |
| display | attendant | 1-MAX ['print' or 'schedule'] |
| remove  | attendant | 1-MAX                         |

1. Brackets [ ] indicate the qualifier is optional. MAX is the maximum number available in your system configuration.

### Form instructions

```

Page 1 of 3
ATTENDANT CONSOLE 1

Type: console           Name: 27 character attd cons name
Extension: 1000         Group: 1           Auto Answer: none
Console Type: principal TN: 1           Data Module? n
Port: 01C1106          COR: 1           Disp Client Redir? n
                      COS: 1           Display Language: english

DIRECT TRUNK GROUP SELECT BUTTON ASSIGNMENTS (Trunk Access Codes)
  Local Remote          Local Remote          Local Remote
1: 9                    5:                    9:
2: 82                   6:                    10:
3:                      7:                    11:
4:                      8:                    12:

HUNDREDS SELECT BUTTON ASSIGNMENTS
1:          5:          9:          13:          17:
2:          6:          10:         14:          18:
3:          7:          11:         15:          19:
4:          8:          12:         16:          20:
```

Screen 5-13. Attendant Console form (page 1 of X)

Make assignments as required for the following fields on each page of the form:

**Page 1 of the form**

- **Attendant Console x** — Enter the console number when completing a paper form. This is a display-only field when the form is accessed using an administration command such as **add** or **change**.
- **Type** — Indicates the type of attendant console being administered. Valid options are **console** (default) and **302B1**.
- **Extension (Optional)** — Enter the extension for the individual attendant console. If an extension is not assigned, the attendant can only be addressed as a member of the attendant group. If the attendant has a data module, the extension field cannot be blank. Default is blank. Once administered, the individual attendant extension can also be entered in any of the following:
  - Any coverage point in a call coverage path (Coverage Path form)
  - CAS Backup Extension (Console Parameters form)
  - Hunt Group Supervisor Extension (Hunt Group form)
  - LDN Night Extension (Listed Directory Numbers form)
  - Stations with system-wide Message Retrieval Permission (Feature-Related System Parameters form)
  - Member of a Hunt Group (Hunt Group form)
  - Incoming Destination for a Trunk Group (Trunk Group forms)
  - Night Service Destination for a Hunt Group (Hunt Group form)
- **Console Type** — Enter this console's intended use. Valid entries are **principal**, **day-only**, **night-only**, or **day/night**. Default is blank. There can only be one night-only or one day/night console in the system unless Tenant Partitioning is administered. Night Service is activated from the principal console or from the one station set per-system that has a nite-serv button.
- **Port** — Enter seven characters.

The entry breaks down as follows:

| Characters | Meaning        | Value         |
|------------|----------------|---------------|
| 1-2        | Cabinet Number | 01 through 44 |
|            |                | 01 through 03 |
|            |                | 01            |



| Characters | Meaning        | Value   |
|------------|----------------|---|
| 3          | Carrier        | A through E   |
| 4-5        | Slot Number    | 01 through 20   |
| 6-7        | Circuit Number | 01 through 08 (digital line circuit pack)<br>01 through 16 (2-wire digital circuit pack)<br>01 through 24 (2-wire digital circuit pack<br>TN2224) |

 **NOTE:**

When using the Administration Without Hardware feature, place an **X** in this field to indicate that there is no hardware associated with this port assignment. An individual attendant extension must be assigned in the `Extension` field.

Each attendant console requires a port on a digital line circuit pack. For reliability, the attendant consoles should not be assigned to ports on the same digital line circuit pack. For example, if three attendant consoles are to be provided, assign each console to a port on three different digital line circuit pack, if possible. However, if required, all attendant consoles can be assigned to ports on the same digital line circuit pack.

- **Name** — Enter the name of this console (up to 27 alphanumeric characters). Any entry is accepted, default is blank.
- **Group** — Enter the Attendant Group number. Default is **1**.
- **TN** — Enter the Tenant Partition number. Default is **1**.
- **COS** — Enter the class of service (COS) for this attendant console (**0** through **15**). Default is **1**.
- **COR** — Enter the class of restriction (**0** through **95**) that reflects the desired restriction. Default is **1**.
- **Auto Answer** — Entering **all** in this field indicates an incoming call to an idle attendant will be answered automatically without any action (no button presses required) by the attendant. Entering **acd** for indicates only ACD split/skill calls and direct agent calls can auto answer. Non-ACD calls terminated to an attendant console with Auto Answer set to **acd** ring audibly. Entering **none** causes all calls terminated to this attendant console to receive some sort of audible ringing treatment. Default is **none**.
- **Data Module** — Enter **y** if the console is to be connected to a data terminal via 7400B or 8400 Data Module. If **y** is entered, complete the Data Module form (page 4). Default is **n**.
- **Disp Client Redir** — This field is administrable only if the `Hospitality` feature has been enabled on the System-Parameters Customer-Options form. This field affects the station's display on calls originated from a station with Client Room Class of Service. When the field is **n** (default), then for all calls originating from a Client Room (even redirected calls) that terminate to this station, this station's display will not show the redirection

information. Only the client name and extension (or room, depending on what is administered on the Hospitality form) displays. When the field is **y**, the redirection information for a call originating from a Client Room and terminating to this station displays.

 **NOTE:**

For stations with an “audix” station type, AUDIX Voice Power ports, or ports for any other type of messaging that needs display information, this field must be **y**.

- **Display Language** — Enter the language in which you want console messages displayed. Valid entries are **English, French, Italian, Spanish,** and **user-defined**. Default is **English**.
- **DIRECT TRUNK GROUP SELECT BUTTON ASSIGNMENTS (Trunk Access Codes)** — Enter the trunk access codes (TACs) for local and remote PBXs. (There are fields for one local TAC and one remote TAC per button labeled *Local* and *Remote*.) The local TAC (1 to 4 digits) refers to a trunk group or Loudspeaker Paging zone on this PBX. Remote TACs are only useful in a private network (including DCS) network. The remote TAC (1 to 3 digits) refers to a trunk group on the remote PBX. If a remote TAC is given, then the local TAC must refer to a trunk group that connects directly to the remote PBX and is also limited to 1 to 3 digits.

Lucent recommends a DCS trunk be specified as the local TAC between the local and remote switches. If the TAC specified as local between the local and remote switches is not a DCS trunk, the remote trunk cannot be monitored by the local switch.

- **HUNDREDS SELECT BUTTON ASSIGNMENTS** — Enter in the appropriate field (1 through 20), the hundreds group to be associated with a Hundreds Group Select button located on an optional selector console. Fields 1 through 8 are used when the selector console is a 24A-type console (See [Figure 5-3](#)) and fields 1 through 20 are used when the console is a 26A-type console (See [Figure 5-3](#)). The hundreds group number entered in the field represents all but the last two digits of an extension number (for example, the Hundreds Select Button — on the selector console — for extension 3822 would be “38”; the Hundreds Select Button for extension 27105 would be “271”). The last two digits of an extension number are obtained (after pressing a Hundreds Group Select button) by pressing the appropriate extension button (00 through 99) on the console.

Page 2 of the form

```

                                     STATION
                                     Page 2 of 4
DATA MODULE
  Data Extension: ____      BCC: 2      ITC: restricted
      Name: _____      COR: 1_     COS: 1_
                                     TN: 1_

ABBREVIATED DIALING
List1: _____

SPECIAL DIALING OPTION: default
  DEFAULT DIALING
    Abbreviated Dialing Dial Code (From above list): _
ASSIGNED MEMBER ( Station with a data extension button for this data module )
  Ext      Name
  1:
  
```

Screen 5-14. Attendant Console Data Module form (page 2 of 4)

This page displays if the Data Module field on Page 1 is **y**. Complete the Data Module form as follows:

- **Data Extension** — Enter the extension number assigned to the data module. A data extension can be a 1- to 5-digit number and must agree with the system's Dial Plan.
  - **BCC** — Display-only field. Only displays when the ISDN-PRI or ISDN-BRI Trunks field is enabled on the System-Parameters Customer-Options form.
-  **NOTE:**  
 The BCC value is used to determine compatibility when non-ISDN facilities are connected to ISDN facilities (ISDN Interworking feature).
- **ITC** — Enter **restricted** or **unrestricted**.
  - **Name** — Enter the name of the user associated with the data module. The name is optional, it can be left blank.
  - **COR** — Enter the desired class of restriction (COR) number from **0** through **95**. Default is **1**.
  - **TN** — Enter the Tenant Partitioning number. Default is **1**.
  - **COS** — Enter the desired (COS) number from **0** through **15** to designate allowed features. See ["Class of Service" on page 4-277](#) for additional information on the allowed features. Default is **1**.
  - **ABBREVIATED DIALING List1:** — Enter **s** (system), **g** (group), **p** (personal), or **e** (enhanced). If **g** or **p** is entered, a group number or personal list number also is required.
  - **SPECIAL DIALING OPTION** — Enter one of three dialing options that are available. This identifies the destination of all calls when this data module originates calls. Valid entries are **hot-line**, **default**, or leave blank.

- **HOT LINE DESTINATION — Abbreviated Dialing Dial Code** — Only displays when the `Special Dialing Option` field is **hot-line**. Enter a dial code within the range of the abbreviated dialing list type. The associated AD number is dialed when the user goes off-hook on a Data Hot Line call.
- **DEFAULT DIALING Abbreviated Dialing Dial Code** — Only displays when the `Special Dialing Option` field is **default**. Enter a dial code within the range of the abbreviated dialing list type. The associated AD number is dialed when the user goes off-hook and enters a carriage return following the “DIAL” prompt. The data call originator also can perform data terminal dialing by specifying a dial string that may or may not contain alphanumeric names.
- **Ext** — Display-only field. This is the extension number of a previously administered user who has an associated Data Extension button and who will share the use of the module.
- **Name** — Display-only field. Contains the name assigned to the above extension number.

Page 3 of the form (page 2 if the Data Module form is not displayed)

|                                |  |                  |
|--------------------------------|--|------------------|
| ATTENDANT CONSOLE              |  | Page Y of X      |
| FEATURE BUTTON ASSIGNMENTS     |  |                  |
| 1: split_____                  |  | 13: _____        |
| 2: _____                       |  | 14: _____        |
| 3: _____                       |  | 15: _____        |
| 4: _____                       |  | 16: _____        |
| 5: _____                       |  | 17: _____        |
| 6: hold _____ *                |  | 18: _____        |
| 7: _____                       |  | 19: forced-rel   |
| 8: aux-work      RC:      Grp: |  | 20: _____        |
| 9: _____                       |  | 21: _____        |
| 10: _____                      |  | 22: _____        |
| 11: _____                      |  | 23: night-serv * |
| 12: _____                      |  | 24: pos-busy_ *  |

Screen 5-15. Attendant Console form (page Y of X)

- **FEATURE BUTTON ASSIGNMENTS** — Enter the feature buttons from [“Attendant Console Feature Button Characteristics”](#) table that you want to assign to the attendant console. The fixed buttons that cannot be changed (that is, split and forced release) are shown on the form. The hold, night-serv, and pos-busy buttons are shown in the system default locations. These buttons can be administered elsewhere on the form. The following provides descriptions of feature buttons that are unique to the

attendant console. See the Button Assignment Tables in this section and to the ["Voice-terminal feature button descriptions" on page 6-14](#) for a description of the feature buttons.

- Audible Tones On/Off
  - **cw-ringoff** — Call waiting ringer off; turns on/off the audible tone for call waiting on attendant console (1 per console).
  - **in-ringoff** — Incoming call ringer off; turns on/off the audible tone for incoming call ringer (1 per console).
  - **re-ringoff** — Timed reminder ringer off; turns on/off the audible tone for timer reminder ringer (1 per console).
- Alternate FRL (**alt-frl**) — Alternate facility restriction level; allows the attendant to activate or deactivate the AFRL feature. When activated, this allows the originating device (lines or trunks) to use an alternate set of the facility restriction levels to originate a call (1 per console).
- Attendant Control of Trunk Group Access
  - **act-tr-grp** — Activate trunk group access; allows the attendant to control a trunk group. All calls going to the trunks are routed to the attendant (1 per console).
  - **deact-tr-g** — Deactivate trunk group access; allows the attendant to release control of a trunk group (1 per console).
- Display Class of Restriction (**class-rstr**) — Used to display the COR associated with a call (1 per console).
- Emergency Access to the Attendant (**em-acc-att**) — The associated status lamp is flashed when there is one or more calls on the emergency attendant queue (1 per console).
- Hold (**hold**) — When the Hold button is pressed while the attendant is active on a loop, the party on the loop is put on hold and the "call type" button associated with the loop is lit (1 per console).
- Position Busy (**pos-busy**) — When this button is pushed, the attendant is put into position busy mode, the "Pos Avail" light is turned off, and the light associated with the pos-busy button is lit. Pushing the pos-busy button a second time takes the console out of "position busy" mode, turns on the "Pos Avail" light and turns off the light associated with the pos-busy button.

If the pos-busy button is administered on a 2-LED button, the top LED flashes when the last attendant goes into "Position Busy" mode. Otherwise, if the button has only one LED, the single LED associated with the pos-busy button flashes (1 per console).
- Serial Call (**serial-cal**) — This button allows the attendant-extended calls to return to the same attendant if the trunk remains off-hook (1 per console).

- Attendant Override (**override**) — This button enables the attendant to override diversion features such as, Call Forwarding, Call Coverage, and so on (1 per console).
- Call Offer (**intrusion**) — Depression of this button allows the attendant to extend a call when the called party is active on another call (1 per console).
- Don't Split (**dont-split**) — This button allows the attendant to not split away a call when dialing (1 per console).
- Visually Impaired Attendant Service (**vis**) — This button activates visually impaired service for the attendant. When this service is activated, the attendant can listen to console status or messages by pressing buttons that have been translated as follows:
  - "con-stat" repeats the console status.
  - "display" calls out display contents.
  - "dtgs-stat" calls out the DTGS status.
  - "last-mess" repeats the last message.
  - "last-op" calls out the last operation.
- Trunk Group Select — In addition to the 12 Direct Trunk Group Selection (DTGS) Button Assignments on Page 1 of the form, up to 12 single lamp DTGS buttons can be administered on this page. The status lamp associated with the feature button is used to monitor the busy/idle status of the trunk. Trunk groups administered on these buttons cannot be controlled using Attendant Control of Trunk Group Select buttons. The single lamp DTGS buttons can be administered as follows:
  - **local-tgs** — Local trunk group select; allows the attendant to access trunk groups on the local PBX (combination of 12 local-tgs/remote-tgs per console).
  - **remote-tgs** — Remote trunk group select; allows the attendant to access trunk groups on a remote PBX (combination of 12 local-tgs/remote-tgs per console).
  - **hundred-sel** — Hundreds group select; in addition to the fixed HGS buttons on Page 1 of the form, a user can administer hundreds group select feature buttons on this page. When a feature button is administered as "hundred-sel," a subfield appears that must then be administered in the same manner as the fixed HGS button fields (a 1 to 3 digit hundreds group plus prefix, if needed). Administered "hundred-sel" feature buttons operate in the same manner as fixed HGS buttons.

The total number of hundreds group select buttons (fixed and administered) allowed on a console is 20. Thus, if all 20 fixed HGS buttons have been administered, no "hundrd-sel" feature buttons can be administered.

 NOTE:

If no fixed HGS buttons are administered, 19 "hundrd-sel" feature buttons are available. This is because 5 of the 24 feature buttons must be used for required feature buttons (hold, pos-busy, night-serv, forced-rel, and split).

- Group Display (**group-disp**) — Allows the attendant to see a display of extensions currently being tracked on the DXS module.
- Group Select (**group-sel**) — Allows the attendant to select a specific group of hundreds by dialing the first 2 or 3 digits of the hundreds group.
- Attendant Room Status
  - **occ-rooms** — Occupied rooms; allows the attendant to see which rooms are occupied.
  - **maid-stat** — Maid status; allows the attendant to see which rooms are in one of six specified states.
- VuStats (**vu-display**) — This button allows users with display terminals and attendants to turn on the VuStats display. The limit to the number of VuStats feature buttons you can administer depends on how many feature buttons are available on the attendant console you are administering. The system is designed to allow you to set up a separate VuStats display format for each feature button. Therefore, agents can change the type of measurements on their display by selecting a different VuStats feature button.
  - If 12 HGS buttons are assigned on page 2 of the form, it is recommended that the "night," "pos-busy," and "hold" buttons be reassigned to locations 20, 21, and 3, respectively. The HGS buttons should then be assigned to the right-most three columns, as required.

## Implementation note

---

- \* These buttons are shown here in their system default locations. However, you can administer these buttons in other locations on the form.

Page 4 of the form (page 3 if the Data Module form is not displayed)

|                                   |               |             |
|-----------------------------------|---------------|-------------|
| ATTENDANT CONSOLE                 |               | Page Y of X |
| DISPLAY MODULE BUTTON ASSIGNMENTS |               |             |
| 1: normal_____                    | 5: delete-msg |             |
| 2: inspect_____                   | 6: call-disp_ |             |
| 3: cov-msg-rt                     | 7: date-time_ |             |
| 4: next_____                      | 8: timer_____ |             |

Screen 5-16. Attendant Console form (page Y of X)

- **DISPLAY MODULE BUTTON ASSIGNMENTS** — Enter the desired feature or functions from [Table 5-1](#). Display-type buttons obtain display functions on the associated alphanumeric display. These buttons are noted as [display button] in the Feature or Function column on the table. Also, several feature buttons can be administered so that their associated status lamps can be used to provide visual indications of the associated feature or function. In some cases, the button itself is not operational. These buttons are noted as [status lamp]. If a Call Cover Msg Rt (cov-msg-rt) button is assigned, a Leave Word Calling Delete Msg (delete-msg) button and a Next (next) button must also be assigned.

**Implementation note**

---

Default feature buttons shown above. Other display feature buttons as noted on Basic Console Feature Button Assignment table can be administered here, as required.



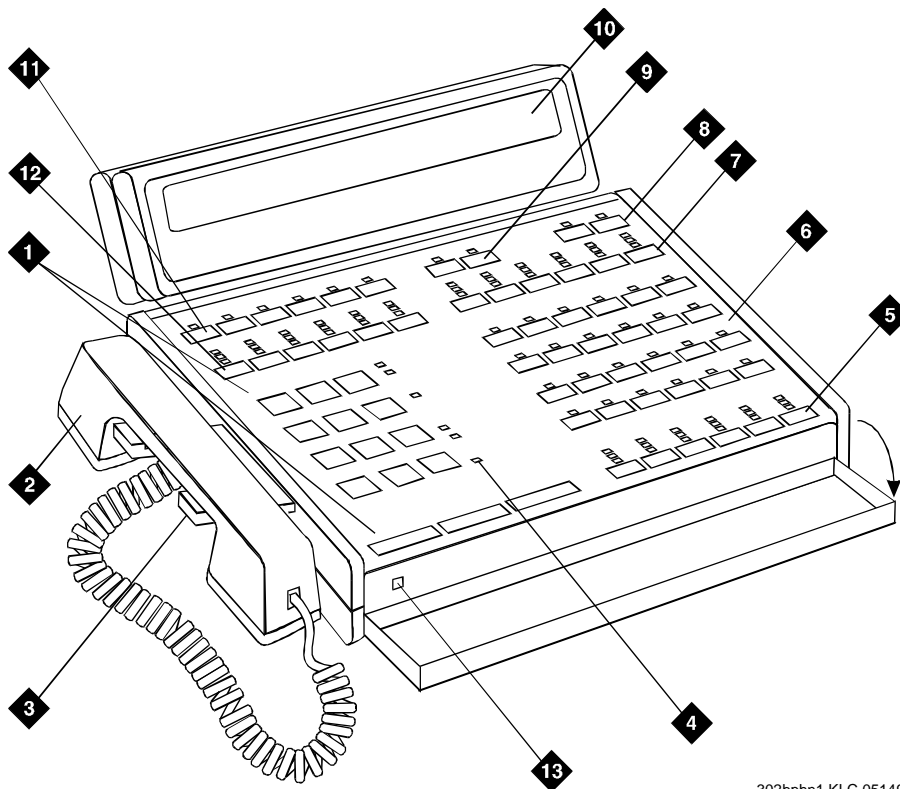

302bphn1 KLC 051496

Figure Notes

- |   |                                |
|---|--------------------------------|
| 1. Call processing area                 | 8. Volume control buttons      |
| 2. Handset                              | 9. Display buttons             |
| 3. Handset cradle                       | 10. Console display panel      |
| 4. Warning lamps and call waiting lamps | 11. Display buttons            |
| 5. Call appearance buttons              | 12. Trunk group select buttons |
| 6. Feature area                         | 13. Lamp Test Switch           |
| 7. Trunk group select buttons           |                                |

Figure 5-1. 302A and 302B Attendant Console

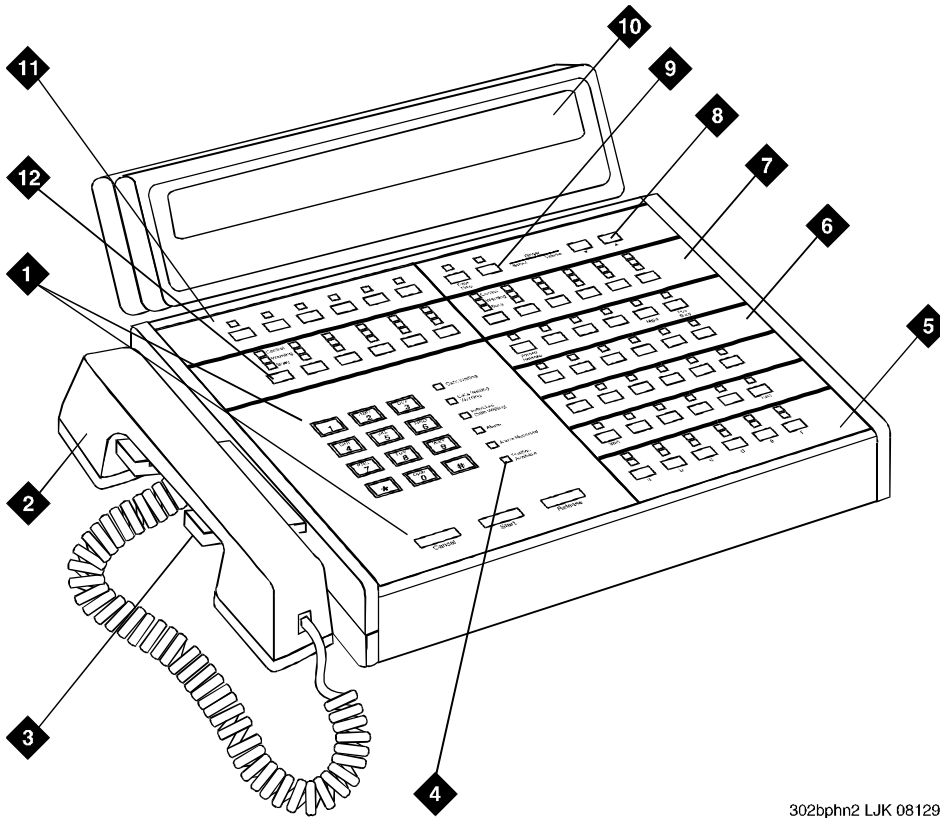

302bphn2 LJK 081296

Figure Notes

- |   |                                |
|---|--------------------------------|
| 1. Call processing area                 | 7. Trunk group select buttons  |
| 2. Handset                              | 8. Volume control buttons      |
| 3. Handset cradle                       | 9. Display buttons             |
| 4. Warning lamps and call waiting lamps | 10. Console display panel      |
| 5. Call appearance buttons              | 11. Display buttons            |
| 6. Feature area                         | 12. Trunk group select buttons |

Figure 5-2. 302C Attendant Console

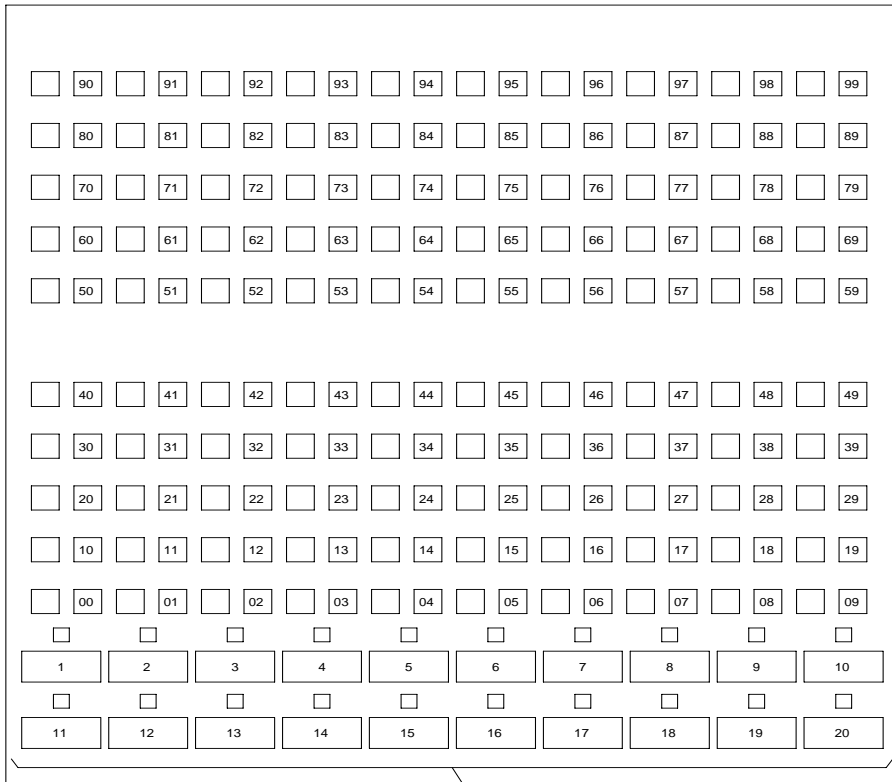

TWENTY ADMINISTRABLE  
HUNDREDS GROUP  
SELECT BUTTONS  
(NUMBERS 1-20 ARE  
FOR IDENTIFICATION  
ONLY)

Figure 5-3. Enhanced Selector Console (26A) Administrable Hundreds Group Select Buttons

**Table 5-1. Attendant Console Feature Button Characteristics**

| <b>Feature or Function</b>                           | <b>Recommended Button Label</b> | <b>Name Entered on Station form</b> | <b>Maximum Allowed</b> | <b>Notes</b> |
|--|---------------------------------|-------------------------------------|------------------------|--------------|
| Abbreviated Dialing                                  | AD                              | abrv-dial (List:___ DC:___)         | 1 per List/DC          | 1            |
| Administered Connection [status lamp]                | AC Alarm                        | ac-alarm                            | 1                      |              |
| Alert Agent of Change to Split/Skill Hunt Group      | Alert Agent                     | alrt-agchg                          | 1                      |              |
| Automatic Call Distribution (ACD)                    | After Call Work                 | after-call (Grp. No. __)            | N                      | 2            |
|  | Assist                          | assist (Grp. No: __)                | 1 per split group      | <u>2</u>     |
|  | Auto In                         | auto-in (Grp. No. __)               | 1 per split group      | <u>2</u>     |
|  | Auxiliary Work                  | aux-work (Grp. No. __)              | 1 per split group      | <u>2</u>     |
|  | Manual-In                       | manual-in (Grp. No. __)             | 1 per split group      | <u>2</u>     |
|  | Release                         | release                             | 1                      |              |
|  | Work Code                       | work-code                           | 1                      |              |
|  | Stroke (0-9)                    | stroke-cnt (Code:_)                 | 1                      | 3            |
| Attendant Console (Calls Waiting)                    | CW Aud Off                      | cw-ringoff                          | 1                      |              |
| Attendant Control of Trunk Group Access (Activate)   | Cont Act                        | act-tr-grp                          | 1                      |              |
| Attendant Control of Trunk Group Access (Deactivate) | Cont Deact                      | deact-tr-g                          | 1                      |              |
| Attendant Direct Trunk Group Select                  | Local TG Remote TG              | local-tgs remote-tgs                | 12                     | 4            |
| Attendant Crisis Alert                               | Crisis Alert                    | crss-alert                          | 1                      |              |
| Attendant Display [display buttons]                  | Date/Time                       | date-time                           | 1                      |              |
|  | Inspect Mode                    | inspect                             | 1                      |              |
|  | Normal Mode                     | normal                              | 1                      |              |
|  | Stored Number                   | stored-num                          | 1                      |              |

*Continued on next page*

Table 5-1. Attendant Console Feature Button Characteristics — *Continued*

| Feature or Function                            | Recommended Button Label | Name Entered on Station form | Maximum Allowed | Notes             |
|--|--------------------------|------------------------------|-----------------|-------------------|
| Attendant Hundreds Group Select                | Group Select _           | hundrd-sel (Grp:_)           | 20 per console  | 5                 |
| Attendant Room Status                          | Occupied Rooms Status    | occ-rooms                    | 1               | 6                 |
|  | Maid Status              | maid-stat                    | 1               | <a href="#">6</a> |
| Attendant Override                             | Override                 | override                     | 1               |                   |
| Automatic Circuit Assurance                    | ACA                      | aca-halt                     | 1 per system    |                   |
| Automatic Wakeup (Hospitality)                 | Auto Wakeup              | auto-wkup                    | 1               |                   |
| Busy Verification                              | Busy Verify              | verify                       | 1               |                   |
| Call Coverage                                  | Cover Cback              | cov-cback                    | 1               |                   |
|  | Consult                  | consult                      | 1               |                   |
|  | Go To Cover              | goto-cover                   | 1               |                   |
| Call Coverage [display button]                 | Cover Msg Rt             | cov-msg-rt                   | 1               |                   |
| Call Offer (Intrusion)                         | Intrusion                | intrusion                    | 1               |                   |
| Call Prompting [display button]                | Caller Info              | callr-info                   | 1               |                   |
| Call Type                                      | Call Type                | type-disp                    | 1               | 7                 |
| Centralized Attendant Service                  | CAS-Backup               | cas-backup                   | 1               |                   |
| Check In/Out (Hospitality) [display buttons]   | Check In                 | check-in                     | 1               |                   |
|  | Check Out                | check-out                    | 1               |                   |
| Class of Restriction [display button]          | COR                      | class-rstr                   | 1               |                   |
| Demand Print                                   | Print Msgs               | print-msgs                   | 1               |                   |
| Do Not Disturb (Hospitality)                   | Do Not Disturb           | dn-dst                       | 1               |                   |
| Do Not Disturb (Hospitality) [display buttons] | Do Not Disturb Ext       | ext-dn-dst                   | 1               |                   |
|  | Do Not Disturb Grp       | grp-dn-dst                   | 1               |                   |

*Continued on next page*

Table 5-1. Attendant Console Feature Button Characteristics — *Continued*

| Feature or Function                    | Recommended Button Label                      | Name Entered on Station form | Maximum Allowed | Notes |
|--|---|------------------------------|-----------------|-------|
| Don't Split                            | Don't Split                                   | dont-split                   | 1               |       |
| Emergency Access To the Attendant      | Emerg. Access To Atndt                        | em-acc-att                   | 1               |       |
| Facility Busy Indication [status lamp] | Busy (trunk or extension#)                    | busy-ind (TAC/Ext: _)        | 1 per TAC/Ext.  | 8     |
| Facility Test Calls [status lamp]      | FTC Alarm                                     | trk-ac-alm                   | 1               |       |
| Group Display                          | Group Display                                 | group-disp                   | 1               | 9     |
| Group Select                           | Group Select                                  | group-sel                    | 1               |       |
| Hardware Failure [status lamps]        | Major Hdwe Failure                            | major-alm                    | 10 per system   |       |
|  | Auto Wakeup                                   | pr-awu-alm                   | 1               |       |
|  | DS1 (facility)                                | ds1-alarm                    | 10 per system   |       |
|  | PMS Failure                                   | pms-alarm                    | 1               |       |
|  | PMS Ptr Alm                                   | pr-pms-alm                   | 1               |       |
|  | CDR 1 Failure                                 | cdr1-alm                     | 1               |       |
|  | CDR 2 Failure                                 | cdr2-alm                     | 1               |       |
|  | Sys Ptr Alm                                   | pr-sys-alm                   | 1               |       |
| Hold                                   | Hold  | hold                         | 1               |       |
| Integrated Directory [display button]  | Integrtd Directory                            | directory                    | 1               |       |
| Incoming Call Identification           | Coverage (Group number, type, name, or ext.#) | in-call-id                   | N               |       |
| Intrusion (Call Offer)                 | Intrusion                                     | intrusion                    | 1               |       |
| Leave Word Calling                     | Cancel LWC                                    | lwc-cancel                   | 1               |       |
|  | LWC   | lwc-store                    | 1               |       |
| Leave Word Calling [display buttons]   | Delete Msg                                    | delete-msg                   | 1               |       |
|  | Next  | next                         | 1               |       |
|  | Call Display                                  | call-disp                    | 1               |       |

*Continued on next page*

Table 5-1. Attendant Console Feature Button Characteristics — Continued

| Feature or Function                                       | Recommended Button Label         | Name Entered on Station form | Maximum Allowed   | Notes              |
|---|----------------------------------|------------------------------|-------------------|--------------------|
| Leave Word Calling (Remote Message Waiting) [status lamp] | Msg (name or extension #)        | aut-msg-wt (Ext:___)         | N                 | <a href="#">8</a>  |
| Link Failure  | Link Failure (Link No. __)       | link-alarm (Link No. __)     | 1 per Link #      | 10                 |
| Login Security Violation                                  | lsvn-halt                        | lsvn-halt                    | 1 per system      |                    |
| Night Service   | Trunk Grp. NS                    | trunk-ns (Grp. No. __)       | 1 per trunk group | 11                 |
| PMS Interface [display buttons]                           | Message Waiting Act.             | mwn-act                      | 1 per system      |                    |
|   | Message Waiting Deact.           | mwn-deact                    | 1 per system      |                    |
| Priority Calling  | Prior Call                       | priority                     | N                 |                    |
| Position Busy   | Position Busy                    | pos-busy                     | 1                 |                    |
| Queue Status Indications (ACD) [display buttons]          | AQC                              | atd-qcalls                   | 1                 |                    |
|   | AQT                              | atd-qtime                    |                   |                    |
| Queue Status Indications (ACD) [status lamps]             | NQC                              | q-calls (Grp:_)              | 1                 | 12                 |
|   | OQT                              | q-time Grp:_)                | 1 per hunt group  | <a href="#">12</a> |
| Remote Access Security Violation                          | rsvn-halt                        | rsvn-halt                    | 1 per system      |                    |
| Ringling  | In Aud Off                       | in-ringoff                   | 1                 |                    |
| Security Violation Notification Halt                      | ssvn-halt                        | ssvn-halt                    | 1 per system      | <a href="#">7</a>  |
| Serial Call   | Serial Call                      | serial-cal                   | 1                 |                    |
| System Reset Alert  | System Reset Alert [status lamp] | rs-alert                     | 1                 |                    |
| Station Security Code Notification Halt                   | ssvn-halt                        | ssvn-halt                    | 1 per system      |                    |
| Night Service (ACD)                                       | Hunt Group                       | hunt-ns (Grp. No. __)        | 3 per hunt group  | 12                 |

Continued on next page

**Table 5-1. Attendant Console Feature Button Characteristics — Continued**

| Feature or Function                      | Recommended Button Label | Name Entered on Station form | Maximum Allowed | Notes  |
|--|--------------------------|------------------------------|-----------------|--------|
| Time of Day Routing<br>[display buttons] | Immediate Override       | man-ovrid                    | 1               |        |
|  | Clocked Override         | clk-overid                   | 1               |        |
| Timed Reminder                           | RC Aud Off               | re-ringoff                   | 1               |        |
| Timer                                    | Timer                    | timer                        | 1               |        |
| Trunk Identification<br>[display button] | Trunk-ID                 | trk-id                       | 1               |        |
| Trunk Group Name<br>[display button]     | Trunk-Name               | trunk-name                   | 1               |        |
| Visually Impaired Service (VIAS)         | VIS                      | vis                          | 1               |        |
|  | Console Status           | con-stat                     | 1               |        |
|  | Display                  | display                      | 1               |        |
|  | DTGS Status              | dtgs-stat                    | 1               |        |
|  | Last Message             | last-mess                    | 1               |        |
|  | Last Operation           | last-op                      | 1               |        |
| VDN of Origin Announcement Repeat        | VOA Repeat               | voa-repeat                   | 1               | 13, 14 |
| VuStats                                  | VuStats                  | vu-display                   | 1               | 13     |

N = any number of buttons on the voice terminal can be assigned to this feature. Feature button descriptions are provided in [“Voice-terminal feature button descriptions” on page 6-14.](#)



- List: List number 1 to 3 where the destination number is stored.  
DC: Dial codes of destination number.
- Grp: The split group number for ACD.
- Code: Enter a stroke code (0 through 9).
- TAC: local-tgs — TAC of local TG  
remote-tgs — (L-TAC) TAC of TG to remote PBX  
remote-tgs — (R-TAC) TAC of TG on remote PBX  
The combination of local-tgs/remote-tgs per console must not exceed 12 (maximum).  
Label associated button appropriately so as to easily identify the trunk group.
- Grp: Enter a hundreds group number (1 through 20).
- Enhanced Hospitality must be optioned on the System-Parameters Customer-Options form.



**5 Basic Forms**  
*Attendant Console*

*Page 5-53*

7. May be assigned either to a voice terminal or an attendant console.
  8. Ext: May be a VDN extension.
  9. This button can be administered as either an attendant display button or a feature button.
  10. Link: A link number — 1 to 8 for multi-carrier cabinets, 1 to 4 for single-carrier cabinets.
  11. Grp: A trunk group number.
  12. Grp: Group number of the hunt group.
  13. VDN of Origin must be enabled.
  14. When this button is pressed, "Call Type 1" (answered public network call), "Call Type 2" (unanswered public network call), or "Call Type 3" (all other calls) displays for 1 second.
-

## Authorization Code — COR Mapping

This form assigns authorization codes and associates them with classes of restriction (CORs). On an internal originating call, the COR assigned the facility (such as station) being used to originate the call and its Partition Group Number (PGN) (when assigned) is used to select a routing pattern. With this, the calling party can dial a 4- to 7-digit authorization code to override the FRL assigned the COR (may be associated with voice/data terminals, incoming trunk groups, remote access trunk groups, or attendant consoles). This allows users within each PGN to have access to all seven FRLs (when assigned) and still remain partitioned. On an incoming remote access call, dialing an authorization code as part of the call dialing sequence selects the COR and the associated PGN to be used in processing the call.

### NOTE:

The use of authorization codes when accessing a Vector Directory Number extension will be denied.

To maximize the security of the system, the following should be considered:

1. Authorization Codes should be administered to the maximum length allowed by the system.
2. Authorization Codes should be nonconsecutive (random) and changed at least quarterly.
3. Authorization Codes should be deactivated immediately if a user leaves the company or changes assignments.
4. Assign each Authorization Code the minimum level of calling permissions required.

### Administration commands

Use the following commands to administer the Authorization Codes form.

| Action  | Object             | Qualifier               |
|---------|--------------------|-------------------------|
| change  | authorization-code | auth (4-7 digit number) |
| display | authorization-code | auth (4-7 digit number) |
| list    | authorization-code | none                    |

### Form instructions

Page 1 of 1

Authorization Code - COR Mapping

Note: XX codes administered. Use "list" to display all codes.

| AC    | COR   | AC    | COR   | AC    | COR   | AC    | COR   | AC    | COR   | AC    | COR   |
|-------|-------|-------|-------|-------|-------|-------|-------|-------|-------|-------|-------|
| _____ | _____ | _____ | _____ | _____ | _____ | _____ | _____ | _____ | _____ | _____ | _____ |
| _____ | _____ | _____ | _____ | _____ | _____ | _____ | _____ | _____ | _____ | _____ | _____ |
| _____ | _____ | _____ | _____ | _____ | _____ | _____ | _____ | _____ | _____ | _____ | _____ |
| _____ | _____ | _____ | _____ | _____ | _____ | _____ | _____ | _____ | _____ | _____ | _____ |
| _____ | _____ | _____ | _____ | _____ | _____ | _____ | _____ | _____ | _____ | _____ | _____ |
| _____ | _____ | _____ | _____ | _____ | _____ | _____ | _____ | _____ | _____ | _____ | _____ |
| _____ | _____ | _____ | _____ | _____ | _____ | _____ | _____ | _____ | _____ | _____ | _____ |
| _____ | _____ | _____ | _____ | _____ | _____ | _____ | _____ | _____ | _____ | _____ | _____ |
| _____ | _____ | _____ | _____ | _____ | _____ | _____ | _____ | _____ | _____ | _____ | _____ |
| _____ | _____ | _____ | _____ | _____ | _____ | _____ | _____ | _____ | _____ | _____ | _____ |
| _____ | _____ | _____ | _____ | _____ | _____ | _____ | _____ | _____ | _____ | _____ | _____ |
| _____ | _____ | _____ | _____ | _____ | _____ | _____ | _____ | _____ | _____ | _____ | _____ |
| _____ | _____ | _____ | _____ | _____ | _____ | _____ | _____ | _____ | _____ | _____ | _____ |
| _____ | _____ | _____ | _____ | _____ | _____ | _____ | _____ | _____ | _____ | _____ | _____ |
| _____ | _____ | _____ | _____ | _____ | _____ | _____ | _____ | _____ | _____ | _____ | _____ |
| _____ | _____ | _____ | _____ | _____ | _____ | _____ | _____ | _____ | _____ | _____ | _____ |
| _____ | _____ | _____ | _____ | _____ | _____ | _____ | _____ | _____ | _____ | _____ | _____ |
| _____ | _____ | _____ | _____ | _____ | _____ | _____ | _____ | _____ | _____ | _____ | _____ |
| _____ | _____ | _____ | _____ | _____ | _____ | _____ | _____ | _____ | _____ | _____ | _____ |
| _____ | _____ | _____ | _____ | _____ | _____ | _____ | _____ | _____ | _____ | _____ | _____ |

Screen 5-17. Authorization Code — COR Mapping form (page 1 of 1)

- Make assignments as required for the following fields on the form:
- **Number of Codes Administered** — This is a display-only field and contains the sum of the number of Authorization Codes that has been administered using the Authorization Codes form.
  - **AC** — Enter the 4- to 7-digit authorization code the user must dial. The number of digits entered must agree with the number assigned to the Authorization Code Length field on the Feature-Related System Parameters form.
-  **NOTE:**  
To enhance system security, choose Authorization Codes of seven random digits.
- **COR** — Enter the desired COR number from **0** through **95**.

## Bulletin Board

---

The Bulletin Board form allows you to change and display the information in the bulletin board.

### Administration commands

---

Use the following commands to administer the Bulletin Board..

| Action  | Object         | Qualifier <sup>1</sup> |
|---------|----------------|------------------------|
| change  | bulletin-board |                        |
| display | bulletin-board | [print or schedule]    |

---

1. Brackets [ ] indicate the qualifier is optional.

### Form instructions

---

#### General Information

##### Creating Bulletin Board Messages

The message line for all pages and all lines of the form will allow you to enter 40 characters. If you enter a blank line, it will display. If you enter two or more succeeding blank lines, the system will consolidate them and only store one. The system will also remove a blank line if it is in line 1 of any of the pages. Blank line consolidation for the first ten lines of Page 1 is independent of blank line consolidation performed for lines 11 through 19 of Page 1.

Tabs are not allowed. If you use a tab, it will move the cursor to the next field.

Any of the following characters are valid for all pages and all lines of the form:

- A through Z
- a through z
- Blank
- 0 through 9
- !@#\$%^&\*()\_+=[{}|\~";:','<.>/?

##### Deleting Bulletin Board Messages

You delete a line from the bulletin board by entering a space as the first character of an existing line. You can, however, add a message line with blank as the first character.

## Storing Bulletin Board Messages

You store the information that you have entered just as you do any other SAT command. That is, you hit the PF3 or <enter> key, depending on your terminal type.

### Page 1 of the Bulletin form

Page 1 of 3

| Message (* indicates high-priority)       | Date     |
|---|----------|
| *Lucent is in the process of              | 03/02/93 |
| *investigating your trunk lockup problem. | 03/02/93 |
| *The Bulletin Board will be updated as    | 03/02/93 |
| *we find information.                     | 03/02/93 |
| * We have identified the problem.         | 03/04/93 |
| *The trunk you added does not provide     | 03/04/93 |
| *disconnect supervision. However, the     | 03/04/93 |
| *trunk group was administered as such.    | 03/04/93 |
| *Please call Pat J. for details.          | 03/04/93 |
| <br>                                      |          |
| We recently added a new trunk group (14)  | 03/02/93 |
| and have had many of the members getting  | 03/02/93 |
| locked up.                                | 03/02/93 |
| We see the error - thanks for checking.   | 03/05/93 |

### Screen 5-18. Sample Bulletin Board form (page 1 of 3)

**Lines 1 through 10** — Lines 1 through 10 of the bulletin board are reserved for high priority messages. These lines are noted with an asterisk (\*) in the first column on the left. If you have an init or inads login you can enter high-priority information to trigger the high-priority message at login time.

**Lines 11 through 19** — Enter any additional information.

**Date** — This is a display-only field. The system enters the date that the line of information was entered or last changed.

### Page 2 and 3 of the Bulletin form

**Lines 1 through 20** — Enter any additional information.

**Date** — This is a display-only field. The system enters the date that the line of information was entered or last changed.

## Cabinet

---

### ⇒ NOTE:

This form is applicable only to R5r and later configurations.

This form describes cabinets and to define mapping between external and internal circuit pack addresses so that circuit packs and ports can be identified in a uniform way.

### Administration commands

---

Use the following commands to administer the Cabinet Administration form.

| Action  | Object  | Qualifier <sup>1</sup>     |
|---------|---------|----------------------------|
| add     | cabinet | xx                         |
| remove  | cabinet | xx                         |
| change  | cabinet | xx                         |
| display | cabinet | xx ['print' or 'schedule'] |
| list    | cabinet | ['print' or 'schedule']    |

- 
1. "xx" is the cabinet number (01-44 for R5r and later). Brackets [ ] indicate the qualifier is optional. Single quotes ( ' ) indicate the text inside the quote must be entered exactly as shown or an abbreviated form of the word may be entered.

**Form instructions**

Page 1 of 1

CABINET

CABINET DESCRIPTION

Cabinet: \_\_\_

Cabinet Layout: \_\_\_\_\_

Cabinet Type: \_\_\_\_\_

Number of Portnetworks: \_\_\_

Survivable Remote EPN: \_\_\_      Survivable Remote Processor ID: \_\_\_\_\_

Room: \_\_\_\_\_

Floor: \_\_\_\_\_

Building: \_\_\_\_\_

CARRIER DESCRIPTION

| Carrier | Carrier Type | Number  | Duplicate |
|---------|--------------|---------|-----------|
| C       | _____        | ___ ___ | ___       |
| B       | _____        | ___ ___ | ___       |
| A       | Processor    |         |           |
| X       | Fan          |         |           |
| D       | _____        | ___ ___ | ___       |
| E       | _____        | ___ ___ | ___       |

**Screen 5-19. Cabinet Administration form**

Make assignments as required for the following fields on the form:

- **Cabinet** — Display-only field. This field shows the cabinet number as entered in the command line.
- **Cabinet Layout** — Enter the type of physical carrier layout. Valid entries are **five-carrier** and **single-carrier-stack**. Default is blank.
- **Cabinet Type** — Display-only field. This field shows the type of cabinet being administered. If cabinet "01" is being administered, this field is "processor." If cabinets "02 through 44" are being administered, this field is "expansion-portnetwork."
- **Number of Port Networks** — Enter the number of PNs in the cabinet. Valid entries are **1** (default), and **2**.
- **Survivable Remote EPN** — Displays only if *Cabinet Type* is "expansion-portnetwork." If set to **y**, the cabinet has a remote si processor that provides a backup if the links to this cabinet are inoperative.
- **Survivable Remote Processor ID** — Displays only if *Survivable Remote EPN* is **y**. Enter the product ID assigned to the remote si. This allows DEFINITY Fault Management to know which machine is the backup for this cabinet. The entry in this field cannot be the same as the entry in the *Production Identification* field in the Maintenance-Related System Parameters form.
- **Room** — Enter up to ten characters identifying the room where the cabinet is located. Default is blank.

- **Floor** — Enter up to ten characters identifying the floor in the building where the cabinet is located. Default is blank.
- **Building** — Enter up to ten characters identifying the building where the cabinet is located. Default is blank.
- **Carrier Type** — Enter the type of carrier in the cabinet being administered. Valid entries are **dup-switch-node**, **expansion-control**, **not-used**, **port**, **processor**, and **switch-node**.
- **Number** — Display-only field. Consists of two fields: the `Designator` and `Number` fields. The `Designator` field contains one of the following entries:
  - **PN** — If the carrier is a port carrier, processor carrier, or unused carrier.
  - **SN** — If the carrier is a switch node carrier, or duplicate switch node carrier.

The `Number` field contains either the switch node number or port network number.

- **Duplicate** — The location for the duplicate of a switch node. Only displays when administration of PNC Duplication is enabled. If the `Carrier Type` is **dup-switch-node**, the field displays the three-character carrier address of the duplicate. The first two characters represent the cabinet number; the third character represents the carrier (A through E).

This is a display-only field if the `Carrier Type` is **switch-node**.

## Implementation notes

This form only displays for R5r and later configurations.

This form is for a 5-carrier cabinet layout. The `Carrier Description` fields vary for a single-carrier stack and for different configurations of switch nodes and port networks.

When adding or removing cabinets you can leave gaps in their numbering. For example, if you are adding a cabinet and want to leave some cabinet numbers available in the middle of the cabinet range for future expansion, then port network numbers are assigned by the system which will always use the lowest available PN.



## CAMA Numbering Format form

This form administers the Centralized Automatic Message Accounting (CAMA) trunks and provides Caller's Emergency Service Identification (CESID) information to the local community's Enhanced 911 system through the local Tandem Office.

This form provides the CESID format by extension number or number blocks. This allows for multiple CESID formats to be sent over multiple CAMA trunk groups allowing for mixed station numbering plans and some limited conversion from non-DID to DID numbers typically required by the Private Switch/Automatic Location Interface (PS/ALI) database.

The default CESID defines the CESID for all extension which are not defined in the `Ext Code` field.

There are 86 CESID entries over three pages. The first page contains the Default CESID and 26 extensions to CESID entries. The second and third pages each contain 30 extensions to CESID entries.

### Administration commands

The ability to change and display CAMA numbering is restricted to Administrators with add/change permission.

Use the following commands to administer the CAMA Numbering Format form.

| Action  | Object         | Qualifier <sup>1</sup>  |
|---------|----------------|-------------------------|
| change  | cama-numbering | —                       |
| display | cama-numbering | ['print' or 'schedule'] |

1. Brackets [] indicate the qualifier is optional. Single quotes (') indicate the text inside the quote must be entered exactly as shown or an abbreviated form of the word may be entered.

**Form instructions**

Make assignments as required for the following fields on the form.

**Page 1 of the form**

Page 1 of 3

CAMA NUMBERING - E911 FORMAT

System CESID Default: 5241100\_\_\_\_\_

| Ext<br>Len | Ext<br>Code | CESID    | Total<br>Length | Ext<br>Len | Ext<br>Code | CESID | Total<br>Length |
|------------|-------------|----------|-----------------|------------|-------------|-------|-----------------|
| 4_         | 11_         | 524_____ | 7_              | —          | —           | —     | —               |
| 4_         | 121_        | 524_____ | 7_              | —          | —           | —     | —               |
| 4_         | 125_        | 5241666_ | 7_              | —          | —           | —     | —               |
| 4_         | 126_        | 5241666_ | 7_              | —          | —           | —     | —               |
| 4_         | 127_        | 5241666_ | 7_              | —          | —           | —     | —               |
| 4_         | 128_        | 5241666_ | 7_              | —          | —           | —     | —               |
| 4_         | 1291_       | 5241291_ | 7_              | —          | —           | —     | —               |
| 4_         | 1292_       | 5241666_ | 7_              | —          | —           | —     | —               |
| —          | —           | —        | —               | —          | —           | —     | —               |
| —          | —           | —        | —               | —          | —           | —     | —               |
| —          | —           | —        | —               | —          | —           | —     | —               |
| —          | —           | —        | —               | —          | —           | —     | —               |
| —          | —           | —        | —               | —          | —           | —     | —               |

**Screen 5-20. CAMA Numbering Format form**

**Field descriptions**

- **System CESID Default** — The default CESID is the CESID sent over the cama trunk if the Ext Code field is not defined on the cama numbering form. Enter 1 to 16 digit number or leave blank (default).
- **Ext Len** — The number of digits in the extension. Valid entries are from 1 to 5 or leave blank (default).
- **Ext Code** — Contains the leading digits or all the digits in the extension for the specified CESID. If the extension length is greater than the number of digits in the extension code, the extension code will be interpreted as a block of digits. For example, if the extension length is 4 and the extension code is 11, the CESID will serve extensions 1100 through 1199. The Ext Code [11] is for a DID block. Ext Code [126] may point a non-DID block to a nearby DID extension 5241666. Valid entries can be up to 5 digits, or leave blank (default).
- **CESID** — The number used to identify the calling terminal within an emergency service system. This field may represent a prefix to an extension or the entire CESID. Enter 1 to 16 digits, or leave blank (default).
- **Total Length** — The total number of digits to send. Valid entries are from 1 to 16 or leave blank (default).

## CDR System Parameters

The Call Detail Recording (CDR) System Parameters form allows the generating of records that contain information about particular calls controlled by the switch. This information is useful for call costing, diagnostics, abuse detection, and network optimization.

### Administration commands

Use the following commands to administer the CDR System Parameters form.

| Action  | Object                | Qualifier |
|---------|-----------------------|-----------|
| change  | system-parameters cdr | —         |
| display | system-parameters cdr | —         |

### Form instructions

#### Page 1 of the form

CDR SYSTEM PARAMETERS Page 1 of X

Node Number (Local PBX ID):  CDR Date Format:

Primary Output Format:  Primary Output Ext:

Secondary Output Format:  Secondary Output Ext:

Use ISDN Layouts?  EIA Device Bit Rate:

Use Enhanced Formats?

Modify Circuit ID Display?  Remove # from Called Number?

Record Outgoing Calls Only?  Intra-switch CDR?

Suppress CDR for Ineffective Call Attempts?  Outg Trk Call Splitting?

Disconnect Information in Place of FRL?  Outg Attd Call Record?

Interworking Feat-flag?

Force Entry of Acct Code for Calls Marked on Toll Analysis Form?

Calls to Hunt Group - Record:

Record Called Vector Directory Number Instead of Group or Member?

Record Called Agent Login ID Instead of Group or Member?

Inc Trk Call Splitting?  Inc Attd Call Record?

Record Non-Call-Assoc TSC?  Call Record Handling Option:

Record Call-Assoc TSC?  Digits to Record for Outgoing Calls:

Privacy - Digits to Hide:  CDR Account Code Length:

#### Screen 5-21. CDR System Parameters form (page 1 of X)

Make assignments as required for the following fields on each page of the form:

- **Node Number (Local PBX ID)** — The DCS switch node number in a network of switches. This field is display only.

- **CDR Date Format** — Enter **month/day** or **day/month** (default) to select the format for recording CDR date information for timestamp date records of all formats. If using a customized format, make Date a six-digit field to ensure the proper output.
- **Primary Output Format** — Controls data presentation sent to the primary output device. Entering **customized** generates the second page of this form for the customized record administration. Other options are **59-char**, **expanded**, **lsu**, **lsu-expand**, **int-direct**, **int-isdn**, **int-process**, **printer**, **teleseer**, **unformatted**, or blank (default).
- **Primary Output Extension** — Appears when the `Primary Output Format` field contains a valid value. Enter the extension number assigned to the primary output device, or **eia** for R5vs/si and later configurations. This field is required if a Primary Output Format is specified. Default is blank.

 **NOTE:**

The first digit of the CDR extension number and the length of that number must agree with the first digit table of the dial plan.

- **Secondary Output Format** — Controls data presentation sent to the secondary output device. Valid entries are **lsu**, **unformatted**, **int-direct**, **int-process** or blank (default).

 **CAUTION:**

*This option should only be used by qualified (Lucent Technologies) service personnel. This option may cause loss of data when the buffer contains large amounts of data.*

- **Secondary Output Extension** — Appears when the secondary output format is administered. Enter the extension number assigned to the secondary output device, or **eia** for R5vs/si and later configurations. Default is blank.

 **NOTE:**

The first digit of the CDR extension number and the length of that number must agree with the first digit table of the dial plan.

- **Use ISDN Layouts** — Enter **y** to use ISDN record layouts. This field applies to both the primary and secondary formats if applicable. The "lsu" and "printer" output formats will be affected, as well as any format with ISDN layouts, such as "teleseer." Default is **n**. This field and `Use Enhanced Formats` cannot both be **y**.
- **EIA Device Bit Rate** — Applies to R5vs/si and later configurations only. Displays if either `Primary` or `Secondary Output Format` is **eia**. Enter the bit rate of the CDR device connected to the EIA port. Valid entries are **300**, **1200**, **2400**, and **9600**.

- **Use Enhanced Formats** — Enter **y** to enable the use of the Enhanced version of the specified primary output format. This field applies to both the primary and secondary output formats if applicable; however, only the "expanded", "teleseer", "lsu", "printer", and "unformatted" output formats will be affected. This field and `Use ISDN Layouts` cannot both be **y**.
- **Modified Circuit ID Display** — Enter **y** to modify the format of the incoming and outgoing circuit ID from the 10's, units, 100's format (the default) to 100's, 10's, units. Only the "printer," "teleseer," and "59-character" output formats will be affected.
- **Remove # From Called Number** — If the value of this field is **n** (default) a trailing "#" (or "E") symbol appears in the `Dialed Number` field whenever inter-digit time out or end of dialing occurs. Enter **y** to have the "#" (or "E") symbol removed from the `Dialed Number` field of the call detail record.
- **Record Outgoing Calls Only** — Enter **y** to report outgoing calls; enter **n** (default) to report both outgoing and incoming calls.
- **Intra-Switch CDR** — Enter **y** to record calls within the switch. Default is **n**.
- **Suppress CDR for Ineffective Call Attempts** — Enter **y** (default) to ignore reporting of ineffective call attempts. Ineffective call attempts are calls originated by a voice terminal user that are blocked because the user did not have sufficient calling privileges or because all outgoing trunks were busy. This includes the unavailable incoming or outgoing trunks due to trunk usage allocation for ISDN Call-by-Call Service Selection trunks and incoming calls rejected by the switch due to NSF mismatch. Enter **n** to report ineffective call attempts.
- **Outg Trk Call Splitting** — Enter **y** to enable splitting of call records for outgoing calls that are transferred or conferenced.
- **Disconnect Information in Place of FRL** — Enter **y** to record disconnect information or "n" (default) to record the call's FRL.



**NOTE:**

This field changes the `Facility Restriction Level (FRL)` field of the CDR record to record the reason for disconnect of a call rather than the FRL. It is used for isolating problems between the `Generic 3r` and the telephone network.

- **Outg Attd Call Record** — Only appears if `Outg Trk Call Splitting` is "y." Enter "y" to enable separate recording of attendant portions of outgoing calls that are transferred or conferenced.
- **Interworking Feat-flag** — Enter **n** (default) if you want feat-flag operation to treat interworking as no answer supervision. Enter **y** if you want feat-flag operation to show interworked calls with a separate feat-flag value than timed answer and network answer calls.

- **Force Entry of Acct Code for Calls Marked on Toll Analysis Form** — Specifies whether an account code will be required when making a toll call. This will not necessarily be all chargeable calls and it may even include some non-chargeable calls. Entering **y** denies all toll calls without an account code. Default is **n**.
- **Calls to Hunt Group — Record** — Enter **member-ext** (default) to record the extension of the voice/data terminal where the call terminated; enter **group-ext** to record the extension that was dialed. The extension of the voice/data terminal in the hunt group that answered the call is the extension assigned to the hunt group.
- **Record Called Vector Directory Number Instead of Group or Member** — Enter **y** to include the Vector Directory Number (VDN) in the `Dialed Number Field` of a CDR record. This field and the `Record Called Agent Login ID Instead of Group or Member` field cannot both be **y**. Default is **n**.



**NOTE:**

A VDN overrides group or member information that is otherwise stored in the `Dialed Number Field` of the CDR record. If a call is directed through more than one VDN, the first VDN used for the call is stored.

- **Record Called Agent Login ID Instead of Group or Member** — Only displays if `Expert Agent Selection (EAS)` is enabled on the `System-Parameters Customer-Options` form. Enter **y** to indicate whether the EAS agents `LoginID` is recorded instead of the physical extension in the `Dialed Number`. This field and the `Record Called Vector Directory Number Instead of Group or Member` field cannot both be **y**.
- **Inc Trk Call Splitting** — Enter **y** to enable splitting of call records for incoming calls that are transferred or conferenced.
- **Inc Attd Call Record** — Only appears if `Inc Trk Call Splitting` is **y**. Enter **y** to enable separate recording of attendant portions of outgoing calls that are transferred or conferenced.
- **Record Non-Call-Assoc TSC** — Enter **y** to record non-call-associated TSC information. Default is **n**.
- **Call Record Handling Option** — Displays on R5r and later configurations only. Used to control call routing when new calls come in, the CDR link is down, and the buffer is filled. Enter **reorder** to block with an intercept, **warning** (default) to stop recording when the buffer is full, or **attendant** to route the call to an attendant with options to proceed as a non-CDR call.



**NOTE:**

Changing this field from the default **warning** may cause ACD & vector calls that are measured by CDR to be redirected.

- **Record Call-Assoc TSC** — Enter **y** to record call-associated TSC information. Default is **n**.
- **Digits to Record for Outgoing Calls** — Enter **dialed** or **outpulsed** to record the dialed or outpulsed digits in the Dialed Number field of the CDR.
- **Privacy — Digits to Hide** — Enter the number of digits (**0 to 7**) to be blanked from the back (right to left) of the Dialed Number field on the CDR record; default is **0**.

For example, if "4" is entered in this field and the user dials 555-1234, only "555" would appear in the Dialed Number field of the CDR record. CDR Privacy must be enabled on the Station form.

- **CDR Account Code Length** — Enter the number of digits collected when the CDR account code is entered. Default is **2**.

Page 2 of the form

| Data Item - Length |   |     | CDR SYSTEM PARAMETERS |   |     | Page 2 of 2        |   |     |
|--------------------|---|-----|-----------------------|---|-----|--------------------|---|-----|
| Data Item - Length |   |     | Data Item - Length    |   |     | Data Item - Length |   |     |
| 1: time            | - | 4   | 17: _____             | - | ___ | 33: _____          | - | ___ |
| 2: space           | - | 1   | 18: _____             | - | ___ | 34: _____          | - | ___ |
| 3: duration        | - | 4   | 19: _____             | - | ___ | 35: _____          | - | ___ |
| 4: return          | - | 1   | 20: _____             | - | ___ | 36: _____          | - | ___ |
| 5: line-feed       | - | 1   | 21: _____             | - | ___ | 37: _____          | - | ___ |
| 6: _____           | - | ___ | 22: _____             | - | ___ | 38: _____          | - | ___ |
| 7: _____           | - | ___ | 23: _____             | - | ___ | 39: _____          | - | ___ |
| 8: _____           | - | ___ | 24: _____             | - | ___ | 40: _____          | - | ___ |
| 9: _____           | - | ___ | 25: _____             | - | ___ | 41: _____          | - | ___ |
| 10: _____          | - | ___ | 26: _____             | - | ___ | 42: _____          | - | ___ |
| 11: _____          | - | ___ | 27: _____             | - | ___ | 43: _____          | - | ___ |
| 12: _____          | - | ___ | 28: _____             | - | ___ | 44: _____          | - | ___ |
| 13: _____          | - | ___ | 29: _____             | - | ___ | 45: _____          | - | ___ |
| 14: _____          | - | ___ | 30: _____             | - | ___ | 46: _____          | - | ___ |
| 15: _____          | - | ___ | 31: _____             | - | ___ | 47: _____          | - | ___ |
| 16: _____          | - | ___ | 32: _____             | - | ___ | 48: _____          | - | ___ |
|                    |   |     | Record length = 11    |   |     |                    |   |     |

Screen 5-22. CDR System Parameters form (page 2 of 2)

This page appears only if Primary Record Format is customized.

**Data Item** — Enter the data items in the order they should appear on the customized record. The default for all fields is blank, but you must enter at least one field in order to have a record. A **line-feed** and **return** must be the last two data items in a customized record (see Page 2 sample). See [Table 5-2](#) below for valid entries:

Table 5-2. Valid Data Item Entries

| Data Item      | Length | Data Item  | Length |
|----------------|--------|------------|--------|
| acct-code      | 15     | ins        | 3      |
| attd-console   | 2      | isdn-cc    | 11     |
| auth-code      | 7      | ixc-code   | 4      |
| bandwidth      | 2      | line-feed  | 1      |
| bcc            | 1      | ma-uui     | 1      |
| calling-num    | 10     | node-num   | 2      |
| clg-num-in-tac | 10     | null       | 1      |
| code-dial      | 4      | out-crt-id | 3      |
| code-used      | 4      | ppm        | 5      |
| cond-code      | 1      | res-flag   | 1      |
| date           | 6      | return     | 1      |
| dialed-num     | 18     | sec-dur    | 5      |
| duration       | 4      | space      | 1      |
| feat-flag      | 1      | time       | 4      |
| fri            | 1      | tsc_ct     | 4      |
| in-crt-id      | 3      | tsc_flag   | 1      |
| in-trk-code    | 4      | vdn        | 5      |

- **Length** — Enter the length of each data item, if different from the default.
- **Record Length** — A display-only field that shows the length of the customized record. This field is updated each time the data item length field is changed.



## Circuit Packs

---

This form administers circuit packs to carrier slots before the circuit packs are actually installed in the carrier or cabinet. This allows the system to be configured (administered) when the circuit packs have not yet been physically inserted in their appropriate slots. Before any voice terminals, attendant consoles, or trunks can be administered in the system, the correct type of circuit pack must be installed in the appropriate slot, or using the Circuit Pack form, a circuit pack must be assigned to the slot.

The Circuit Pack Administration forms do not have to be completed if the system cabinet is equipped with the circuit packs at the time of administration. However, for switch node carriers, these forms must be administered.

See *DEFINITY Communications System Generic 3 Planning and Configuration*, 555-230-601, for additional information on circuit pack administration and Port Assignment Records. (The DS1 circuit pack and associated translation coverage is provided in later in this book).

### **WARNING:**

*For initial installation procedures, circuit packs should only be assigned slots per the hardware Configuration Layout record (obtained from the factory or Customer Services Support Organization). Arbitrarily assigning circuit packs to slots should not be attempted because this eventually requires (at the time of installation and test) realignment of the circuit packs and reworking associated wiring to agree with the software translations or new software translations to agree with the shipped hardware configuration.*

## Administration commands

---

Use the following commands to administer the Circuit Pack form.

| Action  | Object        | Qualifier <sup>1</sup>                      |
|---------|---------------|---|
| change  | circuit-packs | xx (cabinet number)                         |
| display | circuit-packs | xx (cabinet number) ['print' or 'schedule'] |

1. Brackets [ ] indicate the qualifier is optional. Single quotes ( ' ') indicate the text inside the quote must be entered exactly as shown or an abbreviated form of the word may be entered. "xx" is the cabinet number.

### **NOTE:**

If no cabinet number is specified, this command defaults to 1.



 **NOTE:**

For R5r and later configurations, if the Carrier Type (as administered through the Cabinet Administration form) does not match the physical hardware, the Code fields may display question marks.

- **Slot** — Display-only field. The slot equates to the physical slot of the given carrier; the number of slots displayed depends on the system being configured.
  - For R5r and later configurations, the number of slots represent all administrable slots available for the given carrier type.
  - For R5si and later configurations, all slots that could possibly be administered are displayed, even if they do not apply to the current configuration of the system. This is to accommodate the situation when a system is being reconfigured.
- **Code** — Enter the circuit pack code ("TN" followed by a 3- or 4-digit number). If there is a physical circuit pack installed in the slot, the entry must match that of the circuit pack. If there is equipment administered on a slot, the equipment must be removed from the circuit pack before the circuit pack can be changed or removed.
- **Sfx** — Enter the circuit pack suffix, if applicable.
- **Name** — Display-only field. This field shows the alphanumeric name of the circuit pack (such as Digital Line).

 **NOTE:**

When the circuit pack physically inserted in the slot differs from what has been administered on this form, a "#" will display between the Sfx and Name fields.

## Implementation notes

[Screen 5-23](#) shows all fields that may display. The fields that appear on a particular screen will vary depending upon the system configuration (Cabinet Layout and Carrier Type) being administered.

The number of Slot fields displayed will vary depending on the system being configured. For R5r and later configurations, the number of Slot fields displayed will represent all administrable slots available for the given Carrier Type. For R5si and later configurations, all possible Slots will display.

## Class of Restriction

---

This form implements classes of restriction (COR). Use a COR to control call origination and termination. A system may have only one COR or as many as necessary to control calling privileges. Up to 96 different CORs (0 through 95) can be assigned. CORs can be assigned to any of the following facilities:

- Attendant Console
- Authorization Codes
- Console Parameters
- Data Module
- Hunt Groups
- Loudspeaker Paging/Code Calling Access
- Remote Access
- Station
- Terminating Extension Group
- Trunk Groups



**NOTE:**

When a call is to a vector directory number (VDN) extension, the COR of the caller and the VDN are compared to determine if the associated Call Vector can be accessed. After the vector is accessed, the COR of the VDN is used for further call permission checking.

Consider the following to enhance your system security:

1. Assign a separate COR to incoming and outgoing trunk groups, then restrict calling between the two groups.
2. Limit the calling permissions as much as possible by setting appropriate Calling Party Restrictions and Facility Restriction Levels (FRLs).

## Administration commands

Use the following commands to administer the Class of Restriction form.

| Action  | Object            | Qualifier <sup>1</sup>       |
|---------|-------------------|------------------------------|
| change  | cor               | 0-95                         |
| display | cor               | 0-95 ['print' or 'schedule'] |
| list    | cor               | 0-95 ['print' or 'schedule'] |
| list    | partitioned group | ['print' or 'schedule']      |

1. Brackets [ ] indicate the qualifier is optional.

## Form instructions

Make assignments as required for the following fields on each page of the form:

### Page 1 of the form

Page 1 of 3

CLASS OF RESTRICTION

COR Number: 10  
 COR Description: supervisor

FRL: 0 APLT? y

Can Be Service Observed? n Calling Party Restriction: outward

Can Be A Service Observer? n Called Party Restriction: none

Time of Day Chart: 1 Forced Entry of Account Codes? n

Priority Queuing? n Direct Agent Calling? n

Restriction Override: none Facility Access Trunk Test? n

Restricted Call List? n Can Change Coverage? n

Unrestricted Call List? \_ \_ \_ \_ \_

Access to MCT? y Fully Restricted Service? n

Category For MFC ANI: 7 Hear VDN of Origin Annc.? n

Send ANI for MFE? n\_ Add/Remove Agent Skills? n

MF ANI Prefix: \_\_\_\_\_ Automatic Charge Display? n

Hear System Music on Hold? y PASTE (Display PBX Data on Phone)? n

Can Be Picked Up By Directed Call Pickup? n

Can Use Directed Call Pickup? n

Screen 5-24. Class of Restriction form (page 1 of 3)

- **COR Number** — Enter a number from **0** through **95** when completing a paper form. This is a display-only field when the form is accessed via an administration command such as **change** or **display**.

- **COR Description** — Enter a description of the COR of up to 35 characters.
- **FRL** — Enter an originating FRL number from **0-7**. AAR and/or ARS features use this entry to determine call access to an outgoing trunk group. Outgoing call routing is determined by a comparison of the FRLs in the AAR/ARS Routing Pattern and the FRL associated with the COR of the call originator (typically, a voice terminal user). An originating FRL of 0 has the least calling privileges. Default is 0 for all CORs except 10 through 17, where the default increments by one from 0 through 7, respectively.

 **NOTE:**

To enhance system security, assign the lowest possible FRL.

- **APLT** — Enter **n** to allow access to APLT trunk group Enhanced Private Switched Communications System (EPSCS) or Common Control Switched Arrangement (CCSA) off-net facilities. Default is **y**.

 **NOTE:**

If fully restricted service is enabled, set this field to **n**.

- **Can Be Service Observed** — Enter **y** if users with this COR can be service observed, otherwise enter **n** (default). Note that this field allows or denies service observing for not only physical extensions, but also for logical agent IDs and VDNs. If you want an observer to observe users, set the users' CORs to **y** on the observer's COR Service Observing Permission table.
- **Can Be a Service Observer** — Enter **y** if users with this COR can service observe other users, otherwise enter **n** (default). If you want an observer to observe users, set the users' CORs to **y** on the observer's COR Service Observing Permission table.

 **NOTE:**

You cannot enter **y** in the previous two fields unless `Service Observing (Basic)` is enabled on the System-Parameters Customer-Options form.

 **CAUTION:**

*The use of Service Observing features may be subject to federal, state, or local laws, rules, or regulations; or require the consent of one or both of the parties to the conversation. Customers should familiarize themselves with and comply with all applicable laws, rules, and regulations before using these features.*

- **Calling Party Restriction** — Enter one of the following commands:
  - **Origination** — Blocks the calling party from originating a call, except Remote Access calls, from the facility at any time. The party can only receive calls.

- **Outward** — Blocks the calling party from directly accessing the exchange network. To enhance security, this is the default.
- **All-toll** — Blocks the calling party from making ARS and trunk access calls from a facility assigned the COR to certain toll areas as defined in the `Dialed String` field on the Toll Analysis form. The `Dialed String` field must be marked as being associated with the system's Toll List. The call completes if the facility's COR also is associated with an Unrestricted Call List and whose `Dialed String` field also matches the dialed number.
- **Tac-toll** — Blocks the calling party from making trunk access calls from the facility assigned the COR to certain toll areas as defined in the `Dialed String` field on the Toll Analysis form. The `Dialed String` field must be marked as being associated with the system's Toll List. The call completes if the facility's COR also is associated with an Unrestricted Call List and whose `Dialed String` field also matches the dialed number. See ["Toll Analysis" on page 5-299](#) for additional information.
- **None** — No calling party restrictions.

 **NOTE:**

To enhance system security, limit calling permissions as much as possible.

The COR can be overridden by the COS. See the `Trk-to-Trk Restriction Override` field documented with the Class of Service feature.

- **Called Party Restriction** — Enter one of the following commands:"
  - **Inward** — Blocks the calling party from receiving incoming exchange network calls, attendant originated calls, and attendant completed calls.
  - **Manual** — Blocks the called party from receiving all calls except for those originated or extended by the attendant.
  - **Public** — Blocks the called party from receiving public network calls. Attendant calls are allowed to go through to the called party as well as attendant-assisted calls if the `Restriction Override` field in the public restricted station's COR is **attd** or **all**.
  - **Termination** — Blocks the called party from receiving any calls at any time.
  - **None** — No called party restrictions.
- **Partitioned Group Number** — This field appears only if `AAR/ARS Partitioning` field is enabled on the System Parameters Customer-Options form and `Time of Day Routing` field is **n**. Enter the AAR/ARS partitioned group number (1 to 8) associated with this COR.

- **Time of Day Chart** — Appears only if `Time of Day` field is enabled on the System Parameters Customer-Options form. Enter the AAR/ARS time-of-day-chart number (1 to 8) associated with this COR.
- **Forced Entry of Account Codes** — Enter **y** to indicate that an account code must be dialed when making outgoing trunk calls. Entering **n** (default) indicates that an account code is not required. As a result of entering a **y**, any voice terminal assigned the associated COR must dial an account code before making an outgoing call. Any trunk group assigned that COR cannot be accessed until an account code is dialed. If a call is being routed by AAR or ARS, account code checking is not done on the COR.



**NOTE:**

To enhance system security, set this field to **y**.

If the `Forced Entry of Account Codes for Toll Calls` field on the System-Parameters Customer-Options form is **y**, `Forced Entry of Account Codes` may also be required for all outgoing calls.



**NOTE:**

If a COR requiring entry of account codes is assigned a VDN, the route to commands executed by the associated vector will not be successful.

- **Priority Queuing** — Enter **y** to allow the voice terminal user's calls to be placed ahead of non-priority calls in a hunt group queue. Default is **n**.



**NOTE:**

If the `ACD Option` field is not enabled on the System-Parameters Customer-Options form, this field must be **n**.

- **Direct Agent Calling** — Enter **y** to allow a user to originate or receive direct agent calls. Use this whenever a user talks directly with a specific ACD agent, not just anyone in the agent pool. If the system is in Night Service, the call routes to the Night Service extension. Default is **n**.
- **Restriction Override** — Enter the type of user who is allowed to bypass restriction on the conference/transfer or call forwarding operations. Valid entries are **all**, **attendant**, or **none**. To enhance security, default is **none**.
- **Facility Access Trunk Test** — Enter **y** to allow Facility Access Trunk Tests (FAT). Test calls from facilities (for example, voice terminals) will be allowed to complete if their `COR FAT` field is **y**. For calls from facilities whose `COR FAT` field is **n**, intercept treatment will be given. An associated feature button ("trk-ac-alm") status lamp lights when a successful FAT access occurs. Pressing one of the alarm buttons (ten maximum) when its associated status lamp is lit turns off all lamps on all buttons whether the access is still in progress or has completed. Default is **n**.



- **Restricted Call List** — Enter **y** to specify that this COR will have access to the system's Restricted Call List (see Toll Analysis on page [5-299](#)). This list can be used whether the COR is toll restricted. The Restricted Call List (RCL) has priority over the Toll Analysis Unrestricted Call List (UCL). A call attempt from a facility assigned a COR (with `RCL` field set to **y**), whose dialed digit string is on the Toll Analysis form and is marked as being associated with the RCL, will be denied. Default is **n**.
- **Can Change Coverage** — Enter **y** to allow station users with this COR to select one of two previously administered coverage paths or to activate, change, or deactivate call forward all calls or call forward busy/don't answer from any on-site or off-site location.
- **Unrestricted Call List** — Displays when `Calling Party Restriction` is **all-toll** or **tac-toll**. This field allows a user to complete a toll call with "restricted" dialed digits. This field is associated with the `Dialed String` field on the Toll Analysis form. An Unrestricted Call List number is denoted on that form.

Any entries on the Toll Analysis form with an "X" in the Toll List column is "restricted." You cannot complete a restricted call. However, this field overrides that restriction.

For example, if the Toll Analysis form shows a `Dialed String` column entry of 538 and there is an "X" in the Toll List column, the 538 number is restricted. To override this restriction, in the Toll Analysis form, enter **X** in the "5" column under the Unrestricted Call List heading. In the Class of Restriction form, in this field, enter **5** to complete the restriction override.

- **Access to MCT?** — This field refers to Malicious Call Trace. Enter **y** (default) to allow permissions to activate a request to trace a malicious call. Entering **n** does not prevent a station from making entries to the MCT History report.
- **Fully Restricted Service** — When **y** entered for a given COR, stations assigned that COR will not have access to the public network for either incoming or outgoing calls.



**NOTE:**

If this field is enabled, the `APLT` field must be **n**.

- **Category For MFC ANI** — The `Calling Party Category` digit administered in this field is included as part of the ANI information sent to the Central Office on request using R2-MFC signaling. Valid entries are **1** through **10**. Default is **7** (used in other than U.S.).
- **Hear VDN of Origin Announcement** — Enter **y** if users with this COR can receive VDN of Origin messages. Enter **n** to deny the ability to receive VDN of Origin messages.

- **Send ANI for MFE** — Only applicable for Spain. Enter **y** to enable Automatic Number Identification (ANI). When the value is **y**, the PBX sends the calling party's number to the public or IBERCOM network for line charging; **n** indicates block charging. Valid for 2/6 signaling, but not 2/5 signaling.



**NOTE:**

The following field appears only if `Expert Agent Selection (EAS)` is enabled on the Feature-Related System-Parameters form.

- **Add/Remove Agent Skills** — Enter **y** to allow users with this COR to add and remove skills. Enter **n** to prevent use of this feature.
- **MF ANI Prefix** — This field defines the prefix to apply to an extension number when ANI is sent to the CO. This overrides any ANI prefix administered on the Multifrequency Signaling form. This does not apply when ANI is tandemed through the PBX on tandem calls or when ANI for PBX is sent. Valid entry is 1 to 7 digits. Default is blank.
- **Automatic Charge Display** — Enter **y** if you use Advice of Charge or Periodic Pulse Metering and you want call charges to display automatically on users' display sets. Default is **n** (used in other than U.S.).
- **Hear System Music on Hold** — Enter **y** (default) to allow the Music on Hold feature to be activated by a terminal. Enter **n** to prevent use of the feature.
- **PASTE (Display PBX Data on Phone)** — Enter **y** to download all lists. Enter **n** (default) to disallow the PASTE feature.
- **Can Be Picked Up By Directed Call Pickup** — Enter **y** to allow this Station's or EAS agent's calls to be picked up by using the Directed Call Pickup Up feature. Enter **n** (default) to prevent the use of the feature. Set `Directed Call Pickup` on the Feature-Related System Parameters form to **y** to set this field to **y**.
- **Can Use Directed Call Pickup** — Enter **y** to allow the station, attendant, or EAS agent to pick up calls using the Directed Call Pickup feature. Enter **n** (default) to prevent them from using the feature. Set `Directed Call Pickup` on the Feature-Related System Parameters form to **y** to set this field to **y**.

## Implementation note

---

The `Category` for `MFC ANI` field always controls categories for Russian signaling trunks. It also may control categories for R2-MFC signaling trunks, depending on what value is in the `Use COR for Calling Party Category` field on the system-parameters multi-frequency form.

The `Unrestricted Call List` field displays only when the `Calling Party Restriction` field is **All-toll** or **Tac-toll**. Valid entries are **1** through **10** or blank (default).

Page 2 of form

Page 2 of 3

| CLASS OF RESTRICTION   |       |       |       |       |       |       |       |
|--|-------|-------|-------|-------|-------|-------|-------|
| CALLING PERMISSION (Enter y to grant permission to call specified COR) |       |       |       |       |       |       |       |
| 0? n   | 12? n | 24? n | 36? n | 48? n | 60? n | 72? n | 84? n |
| 1? n   | 13? n | 25? n | 37? n | 49? n | 61? n | 73? n | 85? n |
| 2? n   | 14? n | 26? n | 38? n | 50? n | 62? n | 74? n | 86? n |
| 3? n   | 15? n | 27? n | 39? n | 51? n | 63? n | 75? n | 87? n |
| 4? n   | 16? n | 28? n | 40? n | 52? n | 64? n | 76? n | 88? n |
| 5? n   | 17? n | 29? n | 41? n | 53? n | 65? n | 77? n | 89? n |
| 6? n   | 18? n | 30? n | 42? n | 54? n | 66? n | 78? n | 90? n |
| 7? n   | 19? n | 31? n | 43? n | 55? n | 67? n | 79? n | 91? n |
| 8? n   | 20? n | 32? n | 44? n | 56? n | 68? n | 80? n | 92? n |
| 9? n   | 21? n | 33? n | 45? n | 57? n | 69? n | 81? n | 93? n |
| 10? n  | 22? n | 34? n | 46? n | 58? n | 70? n | 82? n | 94? n |
| 11? n  | 23? n | 35? n | 47? n | 59? n | 71? n | 83? n | 95? n |

Screen 5-25. Class of Restriction form (page 2 of 3)

- **CALLING PERMISSION 0 through 95** — Enter **n** (default) for each COR number (0 through 95) that cannot be called by the COR being implemented. A **y** means an originating facility assigned this COR can be used to call facilities assigned this COR.

Page 3 of form

Page 3 of 3

| CLASS OF RESTRICTION   |       |       |       |       |       |       |       |
|--|-------|-------|-------|-------|-------|-------|-------|
| SERVICE OBSERVING PERMISSIONS                                  |       |       |       |       |       |       |       |
| (Enter y to grant permission to service observe specified COR) |       |       |       |       |       |       |       |
| 0? n   | 12? n | 24? n | 36? n | 48? n | 60? n | 72? n | 84? n |
| 1? n   | 13? n | 25? n | 37? n | 49? n | 61? n | 73? n | 85? n |
| 2? n   | 14? n | 26? n | 38? n | 50? n | 62? n | 74? n | 86? n |
| 3? n   | 15? n | 27? n | 39? n | 51? n | 63? n | 75? n | 87? n |
| 4? n   | 16? n | 28? n | 40? n | 52? n | 64? n | 76? n | 88? n |
| 5? n   | 17? n | 29? n | 41? n | 53? n | 65? n | 77? n | 89? n |
| 6? n   | 18? n | 30? n | 42? n | 54? n | 66? n | 78? n | 90? n |
| 7? n   | 19? n | 31? n | 43? n | 55? n | 67? n | 79? n | 91? n |
| 8? n   | 20? n | 32? n | 44? n | 56? n | 68? n | 80? n | 92? n |
| 9? n   | 21? n | 33? n | 45? n | 57? n | 69? n | 81? n | 93? n |
| 10? n  | 22? n | 34? n | 46? n | 58? n | 70? n | 82? n | 94? n |
| 11? n  | 23? n | 35? n | 47? n | 59? n | 71? n | 83? n | 95? n |

Screen 5-26. Class of Restriction form (page 3 of 3)

**SERVICE OBSERVING PERMISSION 0 through 95** — Enter **n** (default) for each COR number (0 through 95) that cannot be observed by the COR being implemented. A **y** grants permission to observe specific CORs.

### List COR Information form

---

| CLASS OF RESTRICTION INFORMATION |                        |
|----------------------------------|------------------------|
| COR                              | Description            |
| 0                                |                        |
| 1                                |                        |
| 2                                | Internal station users |
| 3                                | Remote Access          |
| 4                                | Wideband trunk groups  |
| .                                |                        |
| .                                |                        |
| .                                |                        |
| 95                               |                        |

#### Screen 5-27. Class of Restriction Information

This form displays information about a COR or a range of CORs. To access this form, enter the command `list cor 10` to display information for a single COR or enter `list cor cor 10 to-cor 20` to display a range of COR numbers. The `print` and `schedule` options support this `list cor` command. If the `list cor` command executes without arguments, all assigned CORs display.

## Class of Service

This form administers access permissions for call processing features that require dial code and/or feature button access permission.

**⇒ NOTE:**

Class of Service (COS) does not apply to trunk groups except for the Remote Access feature.

A COS assignment defines whether or not a voice terminal user may access or use the following features and functions. Up to 16 different COS numbers may be administered (0 through 15).

### Administration commands

Use the following commands to access the Class of Service form.

| Action  | Object | Qualifier <sup>1</sup>  |
|---------|--------|-------------------------|
| change  | cos    | —                       |
| display | cos    | ['print' or 'schedule'] |

1. Brackets [ ] indicate the qualifier is optional.

### Form instructions

Page 1 of 1

|                                 | CLASS OF SERVICE |   |   |   |   |   |   |   |   |   |    |    |    |    |    |    |
|---------------------------------|------------------|---|---|---|---|---|---|---|---|---|----|----|----|----|----|----|
|                                 | 0                | 1 | 2 | 3 | 4 | 5 | 6 | 7 | 8 | 9 | 10 | 11 | 12 | 13 | 14 | 15 |
| Auto Callback                   | n                | y | y | n | y | n | y | n | y | n | y  | n  | y  | n  | y  | n  |
| Call Fwd-All Calls              | n                | y | n | y | y | n | n | y | y | n | n  | y  | y  | n  | n  | y  |
| Data Privacy                    | n                | y | n | n | n | y | y | y | n | n | n  | n  | y  | y  | y  | y  |
| Priority Calling                | n                | y | n | n | n | n | n | n | n | y | y  | y  | y  | y  | y  | y  |
| Console Permissions             | n                | n | n | n | n | n | n | n | n | n | n  | n  | n  | n  | n  | n  |
| Off-hook Alert                  | n                | n | n | n | n | n | n | n | n | n | n  | n  | n  | n  | n  | n  |
| Client Room                     | n                | n | n | n | n | n | n | n | n | n | n  | n  | n  | n  | n  | n  |
| Restrict Call Fwd-Off Net       | n                | y | y | y | y | y | y | y | y | y | y  | y  | y  | y  | y  | y  |
| Call Forward Busy/DA            | n                | n | n | n | n | n | n | n | n | n | n  | n  | n  | n  | n  | n  |
| Personal Station Access         | n                | n | n | n | n | n | n | n | n | n | n  | n  | n  | n  | n  | n  |
| Extended Forwarding All         | n                | n | n | n | n | n | n | n | n | n | n  | n  | n  | n  | n  | n  |
| Extended Forwarding B/DA        | n                | n | n | n | n | n | n | n | n | n | n  | n  | n  | n  | n  | n  |
| Trk-to-Trk Restriction Override | n                | n | n | n | n | n | n | n | n | n | n  | n  | n  | n  | n  | n  |
| QSIG Call Offer Originations    | n                | n | n | n | n | n | n | n | n | n | n  | n  | n  | n  | n  | n  |

Make assignments as required on the form:

The form lists the default values for each COS/feature combination. For a particular combination, **y** allows access to the feature and **n** denies access. Assign entries on the form for each COS to be implemented. Default values are shown on the form.

 **NOTE:**

To enhance system security, limit calling permissions as much as possible.

- **Automatic Callback** — (feature)
- **Call Forwarding All Calls** — (feature)
- **Data Privacy** — (feature)
- **Priority Calling** — (feature)
- **Restrict Call Fwd-Off Net** — (feature)
- **Call Forwarding Busy/DA** — (feature)
- **Personal Station Access** — (feature)
- **Console Permission** — (allows multi-appearance voice terminal users to control the following features normally controlled by the attendant):
  - Automatic Wakeup
  - Controlled Restrictions
  - Do Not Disturb
  - Call Forwarding All Calls
  - Integrated Announcement Recording
- **Off-Hook Alert** — (See [“Emergency Access to the Attendant”](#) feature). Requires that either the `Hospitality (Basic)` or `Emergency Access to Attendant` field (optional features) be enabled on the System-Parameters Customer-Option form.
- **Client Room** — (See [“Hospitality Services”](#) — allows use of the Check-In, Check-Out, Room Change/Swap, and Maid Status features). Requires that the `Hospitality` field (optional feature) be enabled on the System-Parameters Customer-Option form. When Client Room is **y**, a user must dial a feature access code (FAC) and then the extension when activating a feature.
- **Personal Station Access** — You cannot change a COS for this field to **y** if `Personal Station Access (PSA)` on the System Parameters Customer-Options form is **n**.
- **Extended Forwarding All** — You cannot change a COS to **y** if `Extended Cvg/Fwd Admin` on the System Parameters Customer-Options form is **n**.

- **Extended Forwarding B/DA** — You cannot change this COS to **y** if Extended Cvg/Fwd Admin on the System Parameters Customer-Options form is **n**.
- **Trk-to-Trk Restriction Override** — If set to **y**, this field supersedes any system and/or COR-to-COR calling party restrictions that would otherwise prohibit the trunk-to-trunk transfer operation for users with this COS.
- **QSIG Call Offer Originations** — For outgoing call offer call originations, set to **y**. Default is **n**.

## Code Calling IDs

The Code Calling IDs form assigns extensions to code calling identification numbers. As many as 125 three-digit chime codes can be provided. Only one extension can be assigned to each chime code. The system translates the ID number associated with a code calling extension to a chime code and then plays the code over a zone loudspeaker as assigned on the Loudspeaker Paging form.

### Administration commands

Use the following commands to administer the Code Calling IDs form.

| Action  | Object                  | Qualifier <sup>1</sup>  |
|---------|-------------------------|-------------------------|
| change  | paging code-calling-ids | —                       |
| display | paging code-calling-ids | ['print' or 'schedule'] |

1. Brackets [ ] indicate the qualifier is optional. Single quotes ( ' ' ) indicate the text inside the quote must be entered exactly as shown or an abbreviated form of the word may be entered.

### Form instructions

Page 1 of 2

CODE CALLING IDs

ID ASSIGNMENTS

| Id   | Ext   | Id   | Ext   | Id   | Ext   | Id   | Ext   | Id   | Ext   |
|------|-------|------|-------|------|-------|------|-------|------|-------|
| 111: | _____ | 141: | _____ | 221: | _____ | 251: | _____ | 331: | _____ |
| 112: | _____ | 142: | _____ | 222: | _____ | 252: | _____ | 332: | _____ |
| 113: | _____ | 143: | _____ | 223: | _____ | 253: | _____ | 333: | _____ |
| 114: | _____ | 144: | _____ | 224: | _____ | 254: | _____ | 334: | _____ |
| 115: | _____ | 145: | _____ | 225: | _____ | 255: | _____ | 335: | _____ |
| 121: | _____ | 151: | _____ | 231: | _____ | 311: | _____ | 341: | _____ |
| 122: | _____ | 152: | _____ | 232: | _____ | 312: | _____ | 342: | _____ |
| 123: | _____ | 153: | _____ | 233: | _____ | 313: | _____ | 343: | _____ |
| 124: | _____ | 154: | _____ | 234: | _____ | 314: | _____ | 344: | _____ |
| 125: | _____ | 155: | _____ | 235: | _____ | 315: | _____ | 345: | _____ |
| 131: | _____ | 211: | _____ | 241: | _____ | 321: | _____ | 351: | _____ |
| 132: | _____ | 212: | _____ | 242: | _____ | 322: | _____ | 352: | _____ |
| 133: | _____ | 213: | _____ | 243: | _____ | 323: | _____ | 353: | _____ |
| 134: | _____ | 214: | _____ | 244: | _____ | 324: | _____ | 354: | _____ |
| 135: | _____ | 215: | _____ | 245: | _____ | 325: | _____ | 355: | _____ |

Screen 5-29. Code Calling IDs form (page 1 of 2)

Make assignments as required for the following fields on each page of the form:



- **Ext** — Enter an assigned or unassigned extension (may not be a VDN extension). The extension, when dialed using Code Calling Access, causes an associated chime signal to be broadcast over the associated zone loudspeaker. Leave this field blank if you do not want to assign a code.

## Console-Parameters

This form administers attendant console group parameters. This includes basic parameters for Centralized Attendant Service (CAS) and Inter-PBX Attendant Service (IAS). A list of the administered attendant consoles also displays on this form.

### Administration commands

Use the following commands to administer the Console-Parameters form.

| Action  | Object             | Qualifier <sup>1</sup>  |
|---------|--------------------|-------------------------|
| change  | console-parameters | —                       |
| display | console-parameters | ['print' or 'schedule'] |

1. Brackets [ ] indicate the qualifier is optional.

### Form instructions

Make assignments as required for the following fields on each page of the form:

#### Page 1 of the form

```

change console-parameters                                     Page 1 of 3
                                                           CONSOLE PARAMETERS
Attendant Group Name: 27 character name OPERATOR
COS: 0                                                       COR: 0
Calls in Queue Warning: 5                                   Attendant Lockout? y
Ext Alert Port (TAAS):
CAS: none
SAC Notification? n                                         Night Service Act. Ext.:
IAS (Branch)? n                                             IAS Tie Trunk Group No.:
IAS Att. Access Code:                                       Alternate FRL Station:
Backup Alerting? n                                         DID-LDN Only to LDN Night Ext? n
TIMING
Time Reminder on Hold (sec): 10                             Return Call Timeout (sec): 10
Time in Queue Warning (sec):
INCOMING CALL REMINDERS
No Answer Timeout (sec): 20                                 Alerting (sec): 40
Secondary Alert on Held Reminder Calls? y
ABBREVIATED DIALING
List1: group 1                                             List2:
List3:
                                                           COMMON SHARED EXTENSIONS
Starting Extension:                                       Count:
    
```

- **Attendant Group Name** — Enter the name (up to 27 characters) of the attendant group.
- **COS** — Enter a class of service (COS) number (0 through 15) that reflects the desired features for the attendant. Default is 1.
- **COR** — Enter the class of restriction (COR) number (0 through 95) that reflects the desired features for the attendant. Default is 1.
- **Calls In Queue Warning** — Enter the number of incoming calls that can be in the attendant queue before the console's second Call Waiting lamp lights. The console's first Call Waiting lamp lights when any incoming calls are waiting to be answered. The second lamp lights when the number of calls waiting equals the value you entered in the Calls in Queue Warning field.
- **Attendant Lockout** — Enter **y** (default) to activate the Privacy — Attendant Lockout feature. If **y** is entered, the attendant is prohibited from reentering a conference call that has been placed on hold unless recalled by a voice terminal user on the call.
- **Ext Alert Port (TAAS)** — Enter the seven-digit port number assigned to the external alerting device. This supports the Night Service — Trunk Answer From Any Station feature.

The entry breaks down as follows:

| Characters | Meaning        | Value                                     |
|------------|----------------|---|
| 1-2        | Cabinet Number | 01 through 22                             |
|            |                | 01 through 03                             |
|            |                | 01 (G3s)                                  |
| 3          | Carrier        | A through E                               |
| 4-5        | Slot Number    | 01 through 20                             |
| 6-7        | Circuit Number | 01 through 08 (Digital Line circuit pack) |



**NOTE:**

When using the Administration Without Hardware feature, place an "X" in this field to indicate that there is no hardware associated with this port assignment.



**NOTE:**

If an **X** is used here, you must also fill in the Ext Alert (TAAS) Extension field.

- **Ext Alert (TAAS) Extension** — Displays only when an **X** is entered in the Ext Alert Port (TAAS) field. This extension is used by the Terminal Translation Feature (TTI) to assign a port to the Ext Alert Port from a terminal on the Ext Alert port during system installation or provisioning.

Once a port is assigned (either via TTI or by changing the `Ext Alert Port` field from the G3-MA or other manager terminal) the extension is automatically removed and treated as unassigned.

- **CAS** — Enter **main**, **branch**, or **none** (default).



**NOTE:**

The `CAS Main` or `Branch` features must be enabled on the System-Parameters Customer-Options form for either of these features to be functional here.

- **SAC Notification** — Enter **y** to enable or **n** (default) to disable Enhanced Attendant Notification for Send All Calls.
- **RLT Trunk Group No.** — Appears only when **branch** is entered in the `CAS` field. Enter the trunk group number corresponding to the Release Link Trunk (RLT) trunk group to the main location when supporting CAS Branch service.
- **CAS Back-Up Ext.** — Appears only when "**branch**" is entered in the `CAS` field. This field handles attendant-seeking calls if the RLT trunk group to the CAS Main PBX is out of service or if CAS Back-Up is activated. This field must be explicitly defined as an extension in the dial plan. Neither a prefixed extension nor a VDN extension is allowed. Valid entries are an extension number for a station, individual attendant console, hunt group, TEG, or blank.
- **Night Service Act. Ext.** — A display-only field that contains the extension of the current night service activation station, if any. Such a station is administered by assigning it a "night-serv" button.
- **IAS (Branch)** — Enter **y** to enable or **n** (default) to disable the Inter-PBX Attendant Service (IAS) Branch feature.



**NOTE:**

`CAS` and `IAS` cannot both be active at the same time.

- **IAS Tie Trunk Group No.** — Enter the number of the tie trunk group to the main for the IAS (Branch). This entry is required when `IAS Branch` is **y**.
- **IAS Att. Access Code** — Enter the extension number of the attendant group at the main PBX. This entry is required when `IAS Branch` is **y**.
- **Alternate FRL Station** — Displays the extension of the alternate FRL activation station.
- **Backup Alerting** — Enter **y** to activate this feature. This means that system users can pick up alerting calls if the attendant queue has reached its warning state. An **n** (default) indicates that the feature is not active.
- **DID-LDN Only to LDN Night Ext.** — Enter **y** to allow only listed directory number (LDN) calls to go to the listed directory night service number extension; otherwise, enter **n** (all attendant seeking calls will be routed there). Default is **n**.

- **Timed Reminder on Hold (sec)** — Enter the time in seconds (**10** through **1024**) that a call remains on hold at the console before the attendant is alerted. In a CAS arrangement, the main and the branch consoles (when administered) should be administered the same. Default is **10**.
- **Return Call Timeout (sec)** — Enter the time in seconds (**10** through **1024**) before a split away call (call extended and ringing a station or otherwise split away from the console) returns to the console, or leave blank. Default is **10**.
- **Time In Queue Warning (sec)** — Enter the number of seconds a call can remain in the attendant queue before activating an alert. Valid entries are **0** through **999** or blank.
- **No Answer Timeout (sec)** — Enter the number of seconds (**10** through **1024**) a call to the attendant can remain unanswered without invoking a more insistent sounding tone, or leave blank.
- **Alerting (sec)** — Enter the number of seconds (**10** through **1024**) after which a held or unanswered call is disconnected from an attendant loop and routed to another attendant or night service.
- **List1, List2, List3** — Enter **system**, **group**, or **enhanced** for each List # as required. If **group** is entered, a subfield for the group number displays. The subfield's default is **1**. Abbreviated Dialing Personal Lists cannot be assigned.
- **Secondary Alert on Held Reminder Calls?** — Enter **y** to begin attendant alerting for Held Reminder Calls with secondary alerting. Enter **n** to have held reminder calls alert the attendant the same as normal calls. Normal calls start with primary alerting and switch to secondary alerting when the No Answer Timeout expires.

**COMMON SHARED EXTENSIONS** — Provided to the attendant group or terminals with console permissions for parking calls. Common Shared Extensions are administered using two fields: a starting extension of the common shared block and the number of common shared extensions in the block.

- **Starting Extension** — Enter an unassigned extension number that conforms to the Dial Plan. These extension numbers can be used by the attendant to park calls.
- **Count** — Enter a number to indicate the number of consecutive extensions, beginning with the Start Extension to be used as common, shared extensions.

These extension numbers, with no physical voice terminals assigned, are used by the attendant to park calls. For example, if you enter 4300/3, the system makes three consecutive extension numbers, 4300, 4301, and 4302, available to the attendant to park calls.

The extensions should be assigned to the optional Attendant Selector Console in the 00 through 09 block (bottom row) in any hundreds group for easy identification by the attendant. The lamp associated with the number will identify "call parked" or "no call parked", instead of busy or idle status.

## Page 2 of the form

Page 2 of 3

CONSOLE PARAMETERS

QUEUE PRIORITIES

- Emergency Access:1\_
- Assistance Call:2\_
- CO Call:2\_
- DID to Attendant:2\_
- Tie Call:2\_
- Redirected DID Call:2\_
- Redirected Call:2\_
- Return Call:2\_
- Serial Call:2\_
- Individual Attendant Access:2\_
- Interpositional:2\_
- Miscellaneous Call:2\_

Call-Type Ordering Withn Priority Levels? n

### Screen 5-31. Console Parameters — Default Attendant Group form (page 2 of 3)

- **Queue Priorities** — Assign a priority level of **1** through **12** to the calls listed below. You may assign the same priority level to more than one call. Priority 1 is the highest priority and is the default for Emergency Access.
  - Emergency Access
  - Assistance Call
  - CO Calls
  - DID to Attendant
  - TIE Call
  - Redirected DID Call
  - Redirected Call
  - Return Call
  - Serial Call
  - Individual Attendant Access
  - Interpositional
  - Miscellaneous Call

- **Call-Type Ordering Within Priority Levels?** — Enter **n** if you wish the calls to be presented in chronological order within the priority levels that you established above under Queue Priorities.  
Enter **y** if you want to present calls by call type. The three call types are:
  - Type 1 — Answered public network
  - Type 2 — Unanswered public network
  - Type 3 — All others (internal, conference, private network, etc.)
- If you chose this option, calls will first be grouped by the priority level that you established above under Queue Priorities, then by call type, and, finally, in the order received.

### Page 3 of the form

Page 3 of 3

CONSOLE PARAMETERS

ASSIGNED MEMBERS ( Installed attendant consoles )

| Type | Grp | TN |
|------|-----|----|
| 1:   | 1   | 1  |
| 2:   | 1   | 1  |
| 3:   | 1   | 1  |
| 4:   | 1   | 1  |
| 5:   | 1   | 1  |
| 6:   | 1   | 1  |
| 7:   | 1   | 1  |

### Screen 5-32. Console Parameters — Default Attendant Group form (page 3 of 3)

- **ASSIGNED MEMBERS (Installed attendant console types)** — Display-only field. A list of all attendants in the group will be displayed. Individual attendant consoles are administered using the Attendant Console form.
- **Grp** — This display-only field contains the Attendant Group number.
- **TN** — This display-only fields contains the Tenant Partition number.

### Implementation note

---

The number of fields will vary based on the maximum number of attendant consoles allowed for your system configuration.

## Coverage Answer Group

---

This form establishes Call Coverage Answer Groups.

An answer group contains up to eight members who act as a coverage point for another user. For example, if several secretaries are responsible for answering a department's redirected calls, all the secretaries could be assigned to an answer group. The answer group is assigned a group number, and that group number appears in the department's coverage path. All terminals in an answer group ring (alert) simultaneously. Any member of the group can answer the call.

Each coverage answer group is identified by a number from 1 through the maximum number allowed by your system configuration (see *DEFINITY Enterprise Communications Server Release 6 System Description Pocket Reference*). The members of the group are identified by their extension number. Any installed voice terminal (but not attendants) can be assigned to a coverage answer group.

### Administration commands

---

Use the following commands to administer the Coverage Answer Group form.

| Action  | Object                | Qualifier <sup>1</sup>                           |
|---------|-----------------------|--|
| add     | coverage answer-group | 1-MAX (or 'next')                                |
| change  | coverage answer-group | 1-MAX  |
| display | coverage answer-group | 1-MAX ['print' or 'schedule']                    |
| list    | coverage answer-group | [1-MAX]['number' x]['to-number' x]<br>['name' x] |
|         |                       | ['count' n]['print' or 'schedule']               |
| remove  | coverage answer-group | 1-MAX  |

1. Brackets [ ] indicate the qualifier is optional. Single quotes ( ' ') indicate the text inside the quote must be entered exactly as shown or an abbreviated form of the word may be entered. MAX is the maximum number available in your system configuration.



## Form instructions

---

Page 1 of 1

COVERAGE ANSWER GROUP

Group Number: \_\_\_\_\_  
Group Name: COVERAGE\_GROUP\_

GROUP MEMBER ASSIGNMENTS

|    | Ext   | Name  |    | Ext   | Name  |
|----|-------|-------|----|-------|-------|
| 1: | _____ | _____ | 5: | _____ | _____ |
| 2: | _____ | _____ | 6: | _____ | _____ |
| 3: | _____ | _____ | 7: | _____ | _____ |
| 4: | _____ | _____ | 8: | _____ | _____ |

### Screen 5-33. Coverage Answer Group form (page 1 of 1)

Make assignments as required for the following fields on the form:

- **Group Number** — Enter a group number when completing a paper form. This is a display-only field when the form is accessed using an administration command such as **add** or **change**.
- **Group Name** — Enter the group name you want to use to identify this group. Up to 27 characters can be used, for example, typing pool, room 12, secy, and so on. Default is **COVERAGE GROUP**.



#### NOTE:

Performance Tip — Enter the extension numbers that are group members. This allows a list coverage answer group command to be used to list the voice terminals that will be alerted. The list command can be used in conjunction with the list station, list coverage path, and list hunt group commands to determine stations involved in call coverage. This makes it possible to follow call coverage for any extension, allowing the administrator to easily track call coverage paths.

- **Ext** — Enter the extension number (may not be a Vector Directory Number extension) for each member of this coverage answer group.
- **Name** — Display-only field. The name is assigned when the member's voice terminal is administered.

## Coverage Path

This form implements Call Coverage Paths. The form includes the don't answer time interval (number of rings), the call coverage criteria, and the points in the coverage path used to redirect calls.

Call coverage provides internal system users with automatic redirection of calls to answering positions. Both internal and outside calls may be redirected to coverage.

### Administration commands

Use the following commands to administer the Coverage Path form.

|   | Action  | Object        | Qualifier <sup>1</sup>   |
|---|---------|---------------|--|
| Without Hospitality<br>Parameter<br>Reduction Feature | add     | coverage path | 1-MAX (or 'next')  |
|   | change  | coverage path | 1-MAX  |
|   | display | coverage path | 1-MAX ['print' or 'schedule']  |
|   | list    | coverage path | [1-MAX]['path' x]<br>['to-path' x]['count' n]<br>['print' or 'schedule'] |
|   | remove  | coverage path | 1-MAX  |
| With Hospitality<br>Parameter<br>Reduction Feature    | add     | coverage path | 1-5 (or 'next')  |
|   | change  | coverage path | 1-5  |
|   | display | coverage path | 1-5 ['print' or 'schedule']  |
|   | list    | coverage path | [1-5]['path' x]<br>['to-path' x]['count' n]<br>['print' or 'schedule']   |
|   | remove  | coverage path | 1-5  |

1. Brackets [ ] indicate the qualifier is optional. Single quotes ( ' ') indicate the text inside the quote must be entered exactly as shown or an abbreviated form of the word may be entered. MAX is the maximum number available in your system configuration.

**Form instructions**

Page 1 of 1

COVERAGE PATH

Coverage Path Number: \_  
 Call Classifier: \_      Hunt After Coverage:  
 Next Path Number: \_\_\_      Linkage: \_\_\_ \_

COVERAGE CRITERIA

| Station/Group Status | Inside Call | Outside Call |
|----------------------|-------------|--------------|
| Active?              | n           | n            |
| Busy?                | y           | y            |
| Don't Answer?        | y           | y            |
| All?                 | n           | n            |
| DND/SAC/Goto Cover?  | y           | y            |

Number of Rings: 2

COVERAGE POINTS

Terminate to Coverage Pts. with Bridged Appearance? n

Point1: \_\_\_ Point2: \_\_\_ Point3: \_\_\_  
 Point4: \_\_\_ Point5: \_\_\_ Point6: \_\_\_

**Screen 5-34. Coverage Path form (page 1 of 1)**

Make assignments as required for the following fields on the form:

- **Coverage Path Number** — This is a display-only field if the form is accessed using an administration command such as display, add, or change. If the `Hospitality Parameter Reduction` option is enabled on the `System-Parameters Customer-Options` form, only five (maximum) coverage paths can be assigned in the system.
- **Hunt After Coverage** — Enter **y** if you want the system to attempt Station Hunting from the last coverage point, if the coverage point is a busy station. Default is **n**.
- **Next Path Number** — Enter the number of the coverage path to which a call will be redirected in case of coverage failure (the path's coverage criteria does not match the call status) at the current path. If the next path's coverage criteria matches the call status, that path is used to redirect the call and no other path is searched.
- **Linkage** — A display-only field that shows up to two additional coverage paths, when assigned, that `Next Path Number` entry is linked to. A typical linkage example is provided in this section. Six Coverage Paths (1, 2, 3, 4, 5, 6) are shown.
- **COVERAGE CRITERIA** are the conditions that, when met, cause the call to redirect to coverage. Assign one of the following:
  - Active — At least one call appearance is busy.

- Busy — Only one call appearance is idle. If `Restrict Last Appearance` is `n` on the Station form, then no call appearances are idle.
- Don't Answer — The number of rings has exceeded the preset number.
- All — Users with this path assigned will never answer their own calls; instead, all calls go immediately to coverage.
- DND/SAC/Goto Cover — DND(Do Not Disturb)/SAC/Goto Cover allows users to activate `Send All Calls` and to temporarily direct all incoming calls to coverage regardless of the assigned Call Coverage redirection criteria. This feature also allows covering users to temporarily remove their voice terminals from the coverage path.
- **Active, Busy, Don't Answer, All and DND/SAC/Goto Cover** — Enter a "y" to activate. This specifies the condition that, when met, causes a call to redirect to coverage.
- **Number of Rings** — Enter the number of rings from **1** through **99**. Three rings is the recommended timing. This is the number of rings a user's voice terminal rings before the system sees a "no answer" condition and sends the call to the first coverage point. Default is 3.
- **Terminate to Coverage Pts. with Bridged Appearances** — Set to `y` to allow a call to alert as both a bridged call and a redirected call. Set to `n` (default) for the call to skip the coverage point if it has already alerted as a bridged call.
- **COVERAGE POINTS** — Allows you to define the Call Coverage Paths. Coverage points must be assigned sequentially beginning with Point 1 (do not leave gaps).

Each coverage path can have up to six alternate answering points, any of which can be

- A voice terminal or individual attendant (an extension number of a user who will be responsible for answering another user's redirected calls)
- Any off-net public number (see ["Remote Call Coverage Table" on page 5-263](#))
- Recorded Announcement
- Audio Information Exchange (AUDIX)
- A Hunt Group Number
- A Coverage Answer Group Number

- The Attendant Group ("attd")
- A vector Directory Number (only the last)



**NOTE:**

A Vector Directory Number may be translated as the last administered point in a coverage path.

When entering coverage points information, use the following notations:

- The letter "h" to indicate hunt, followed by a hunt group number. For example, enter "h32" if you want a coverage point routed to hunt group number 32.
  - The letter "c" to indicate coverage answer group followed by the coverage answer group number. For example, enter "c20" if you want a coverage point routed to call coverage answer group 20.
  - The letter "r" to indicate remote coverage point followed by the remote coverage point number. For example, enter "r27" if you want a coverage point routed to remote coverage point 27.
  - The letter "v" to indicate VDN followed by the VDN extension number. For example, enter "v12345" if you want the last administered coverage point to be the VDN associated with extension 12345.
  - "Attd" if you want a coverage point to be the attendant group.
  - The extension number assigned to a voice terminal, announcement.
- **Point1, Point2, Point3, Point4, Point5, Point6,** — Enter one of the following:
- An extension number for the voice terminal or announcement
  - "attd" for the attendant group
  - h1 through h255 for a hunt group
  - c1 through c750 for a coverage point
  - r1 through r999 for a remote coverage point
  - v+extension (e.g., v12345) for a VDN

If calls redirect to an AUDIX in a DCS network, administer a unique Hunt Group form. Assign the AUDIX extension in the `Group Extension` field. If the AUDIX is connected to the local node, set the `Message Center` field to **audix**; if the AUDIX is connected to another node, set the `Message Center` field to **rem-audix**.

If you set this field to **attd** and the system has Centralized Attendant Service (CAS), the call goes to the CAS attendant.

If calls redirect to Message Center (a special Uniform Call Distribution hunt group), AUDIX, or to the attendant, do not list any additional coverage points. These calls will normally queue and never redirect to another coverage point. Calls to any hunt group will queue if possible. Calls redirect from a hunt group only if all hunt group members are busy and either the queue is full or there is no queue.

If the Coverage of Calls Redirected Off-Net feature is not enabled, a remote coverage point will function as the last point in the coverage path, because the system will no longer have control of the call once it is redirected off-net. However, if the Coverage of Calls Redirected Off-Net feature is enabled, a call redirected off-net can be monitored by the system and brought back for further call coverage processing.

## Dial Plan Record

The Dial Plan is the system's guide to translating the digits dialed by various System users. Both the Dial Plan Record and the Second Digit Table forms define your system's dial plan. Typical Dial Plan examples are shown for both Single-Digit and Mixed Station Numbering.

### Administration commands

Use the following commands to administer the Dial Plan Record form.

| Action  | Object   | Qualifier <sup>1</sup> |
|---------|----------|------------------------|
| change  | dialplan | —                      |
| display | dialplan | [print or schedule]    |

1. Brackets [ ] indicate the qualifier is optional.

### Form instructions

DIAL PLAN RECORD Page 1 of 1

North American Area Code: 908 Local Node Number: \_\_\_

ARS Prefix 1 Required? y ETA Node Number:

Uniform Dialing Plan: 4-digit ETA Routing Pattern:

UDP Extension Search Order: local-extensions-first

FIRST DIGIT TABLE

| First Digit | -1-   | -2-   | -3-   | -4-   | -5-   | -6-   |
|-------------|-------|-------|-------|-------|-------|-------|
| 1:          | _____ | _____ | _____ | _____ | _____ | _____ |
| 2:          | _____ | _____ | _____ | _____ | _____ | _____ |
| 3:          | _____ | _____ | _____ | _____ | _____ | _____ |
| 4:          | _____ | _____ | _____ | _____ | _____ | _____ |
| 5:          | _____ | _____ | _____ | _____ | _____ | _____ |
| 6:          | _____ | _____ | _____ | _____ | _____ | _____ |
| 7:          | _____ | _____ | _____ | _____ | _____ | _____ |
| 8:          | _____ | _____ | _____ | _____ | _____ | _____ |
| 9:          | _____ | _____ | _____ | _____ | _____ | _____ |
| 0:          | _____ | _____ | _____ | _____ | _____ | _____ |
| *:          | _____ | _____ | _____ | _____ | _____ | _____ |
| #:          | _____ | _____ | _____ | _____ | _____ | _____ |

Screen 5-35. Dial Plan Record form (page 1 of 1)

Make assignments as required for the following fields on the form:

- **North American Area Code** — Required only in North America. Enter the area code number where the System is located. Valid entries are any area code in the form NXX where N is any digit 2 through 9 and X is any digit 0 through 9. Entry must be all digits. Leave blank if not in North America.
- **Local Node Number** — Enter a number from **1** through **63** to uniquely identify a node in a PBX network. The Node Number is used by the automatic restoration capability of Administered Connections. This entry must match the Distributed Communications System (DCS) switch node number and the CDR node number if they are specified. The field may be left blank if automatic restoration, DCS, and CDR are not used.
- **ETA Node Number** — Enter the number of the destination switch for ETA calls.
- **ETA Routing Pattern** — Enter the number of the routing pattern to reach the destination switch.
- **ARS Prefix 1 Required** — Only displays if *North American Area Code* is not blank. Enter **y** (default) if dialing a "1" is required to call an area code. Enter **y** if the office codes in the HNPA are interchangeable with NPAs. Requiring a "1" Prefix typically is used within those area codes where local central office codes resemble area codes (that is, middle digit is a "0" or a "1"). For example, 201 in New Jersey, or 212 in New York.
- **Uniform Dialing Plan** — Enter **4-digit** or **5-digit** to signify the use of a 4- or 5-digit Dial Plan, or **none** (default) if no Uniform Dialing Plan (UDP) is to be administered.



**NOTE:**

The *Uniform Dialing Plan* field must be enabled on the System-Parameters Customer-Option form before any entry other than **none** can be entered in this field.

The Uniform Dialing Plan is a separate form that must be administered if **4-digit** or **5-digit** is entered in this field. See [“Uniform Dial Plan Form” on page 12-121](#) for more information.



**CAUTION:**

*If the entry in the Uniform Dialing Plan field is changed from its previously administered value, all UDP extension codes will be lost.*

The UDP provides a common 4- or 5-digit dial plan that can be shared among a group of switches. Interswitch dialing and intraswitch dialing both require 4- or 5-digit dialing. The UDP is used with Electronic Tandem Network (ETN), Main/Satellite/Tributary, and DCS configurations. Additionally, UDP can be used alone to provide uniform 4- or 5-digit dialing between two or more private switching systems without ETN, DCS, or Main/Satellite/Tributary configurations.



 **NOTE:**

Local extensions of fewer digits can still be administered, but cannot be reached from other switches.

- **UDP Extension Search Order** — Displays when `Uniform Dialing Plan` is **4-digit** or **5-digit**. Indicates where the system should look for a dialed extension first. Valid entries are **local-extensions-first** (default) and **udp-table-first**.

When "**local-extensions-first**" is selected, the dialed extension will be searched for in local translation first. If found, the call terminates to the local station. If the extension is not found locally, the UDP tables will be searched for an off-switch (UDP) conversion.

When "**udp-table-first**" is selected, the UDP tables will be searched first.

- **First Digit table** — This table consists of fields for each possible first digit and dialed number length. The first digit ranges from **0** through **9** plus the \* (star) and # (pound) symbols. The dialed digit length ranges from **1** through **6**. Enter one of the following values in each field on the table (referred to as dial types):

- blank (no object is assigned) — All fields default to blank.
- **extension** (primary extension) — Can have a first digit of 0 through 9 (\* and # not allowed) and can be 1 to 5 digits in length.

For example, if extensions 400 through 499 are required, **extension** is entered at the intersection of the "-3-" column and the First Digit "4" row. If a 4-digit number is administered with a first digit of 6, the extension numbers 6000 through 6999 will be allowed (**extension** is entered at the intersection of the "-4-" column and the First Digit "6" row). Note the **extension** cannot have the same first digit as the ARS or AAR facility access code (FAC).

 **NOTE:**

If the Uniform Dialing Plan is enabled, it is recommended that no extensions be administered that begin with **0**. In the United States of America, **0** is usually the attendant.

- **fac** (feature access code) — Can have a first digit of **0** through **9** plus the \* (star) and # (pound) symbols. A FAC can be from one to four digits in length. The \* and # symbols each count as a digit when used and must be the first digit. For example, \*2 could be used to activate a feature and #2 used to deactivate the feature. It is recommended that a FAC be the last item entered in a row when mixed numbering is used. Otherwise, problems may be encountered when 3-digit FACs and 4-digit extension numbers begin with the same first digit and the FAC is an abbreviated dialing list access code. If the abbreviated dial list entry that a user wants to dial in on a station feature button, no problems will be encountered in dialing. If you manually dial the access code and

the list entry number, you must wait for the inter-digit time-out to expire after dialing the list access code and before dialing the list entry number. Otherwise, the call will go to intercept or to an extension number.

The system requires that FACs for AAR and ARS have the longest length for a first digit in the First Digit Table.

- **dac** (dial access code) — Can have a first digit of **0** through **9** (plus the \* and # symbols) and be from one to four digits in length.

The system requires that a DAC have the longest length for a first digit in the First Digit Table.

You can use the dial access code (DAC) to activate or deactivate a switch feature or to seize a trunk from a trunk group, or both. In the first case, the DAC functions as a feature access code, in the second as a trunk access code.

You can use 4-digit DACs for ordinary trunk access, but they do not work for attendant control of trunk groups, trunk-ID buttons, or DCS, and only the last 3 digits of the codes can be recorded in CDR records. A DAC *must be the last item entered* in a row when mixed station numbering is used.

- **attd** — The attendant group number can be administered for dialed length of 1, and can have a first digit of **0** through **9**, or the two-digit attendant group number whose first digit is defined as "misc" and whose second digit (**0** through **9**) is defined on the Second Digit Table form.
- "misc" — Can have a dialed length of 1, and can have a first digit of **0** through **9**. This call type specifies that the call types for this digit are actually determined in the Second Digit Table.
- "pextension" — Is made up of a prefix (first digit) that can be a **0** through **9** (\* and # not allowed) and an extension number of up to five digits in length. The maximum length of a prefix and extension combination is six digits. When a prefixed extension is entered in the dial plan, a TAC cannot be entered before the prefixed extension on the same row in the table. If a first digit is already assigned as a TAC, a prefixed digit cannot be entered after the tac on the same row in the table. The purpose of the prefix is to identify the dial type as an extension. After digit collection, the prefix digit is removed from the string of dialed digits. The remaining digits (extension number) are then processed. A prefixed extension allows the use of extensions numbers with any first digit (the extension length must be specified on the table). The "prefixed extension" cannot have the same first digit as the ARS or AAR facility access code (FAC).

 **NOTE:**

When a dial plan has mixed station numbering, extensions of various lengths (all with the same first digit) are mapped on

the First Digit table as shown on Page 1 of the form. The system then employs an inter-digit time-out to ensure that all dialed digits are collected. The inter-digit time-out may add several seconds to the dial time. An alternative to the delay required in the time-out mechanism at the expense of dialing an extra digit is to use prefixed extensions in the dial plan.

 **WARNING:**

*Changing from 4 digit to 5 digit (and vice versa) Uniform Dialing Plan will cause all UDP extension codes to be removed.*

## Duplication-Related System Parameters

---

**⇒ NOTE:**

This form only applies to R5r and later configurations.

Used to enable or disable operation of Switch Processing Element (SPE) and Port Network Connectivity (PNC) duplication. The following must be duplicated:

- Each switch node record and every switch node with its duplicate (cabinet administration is a prerequisite)
- Every fiber link containing either an expansion interface circuit pack as an endpoint, or a DS1C (fiber link administration is a prerequisite; circuit pack administration then follows duplication administration)

All nonduplicated switch node interfaces (SNI) to SNI fiber links are automatically duplicated.

**⇒ NOTE:**

The PNC Duplication field must be enabled with the *system-parameters customer-options* command before any duplication administration can be performed.

### Administration commands

---

Use the following commands to administer the Duplication-Related System Parameters form.

| Action  | Object                        | Qualifier |
|---------|-------------------------------|-----------|
| change  | system-parameters duplication |           |
| display | system-parameters duplication |           |

### Form instructions

---

```
DUPLICATION-RELATED SYSTEM PARAMETERS
Enable Operation of SPE Duplication? y
Enable Operation of PNC Duplication? y
```

Make assignments as required for the following fields on the form:

- **Enable Operation of SPE Duplication** — Enter **y** to enable or **n** (default) to disable operation of SPE duplication.
- **Enable Operation of PNC Duplication** — Enter **y** to enable or **n** (default) to disable operation of PNC duplication. This field appears only if `PNC Duplication` has been enabled on the System-Parameters Customer-Options form.

PNC Duplication cannot be enabled until all pnc-a and pnc-b boards are released from the “busyout” state and duplicate TN2238s have been administered for every port network.

Once enabled, PNC Duplication cannot be disabled until all pnc-a boards are made active and all pnc-b boards are in the “busyout” state.

## ETA Call Screening Table

This form allows a set of digit strings to be identified that should not be routed via Extended Trunks Access (ETA). This form can also block the routing of certain FACs or TACs. For example, if the system administrator were to notice a digit string being mistakenly dialed repeatedly that ended up being routed via ETA to a remote PBX only to have the remote PBX returning intercept treatment, then that digit string would be a candidate for the entry into the ETA call screening table. Entry into this table would have the effect of return intercept treatment to the caller without first attempting to route the digits to the remote PBX for interpretation via ETA.

### Administration commands

Use the following commands to administer the ETA Call Screening form.

| Action  | Object         | Qualifier <sup>1</sup> |
|---------|----------------|------------------------|
| change  | call-screening |                        |
| display | call-screening |                        |

1. Brackets [ ] indicate the qualifier is optional.

### Form instructions

Page 1 of 1

ETA CALL SCREENING TABLE

Entry

No. Call Screening Entry

0: \_\_\_\_\_

1: \_\_\_\_\_

2: \_\_\_\_\_

3: \_\_\_\_\_

4: \_\_\_\_\_

5: \_\_\_\_\_

6: \_\_\_\_\_

7: \_\_\_\_\_

8: \_\_\_\_\_

9: \_\_\_\_\_

Screen 5-37. ETA Call Screening Table form (page 1 of 1)

Make assignments as required for the following fields on the form:

- **Call Screening Entry** — Assign those digit strings (up to 10) that should be blocked for this RNX. Each string can have up to 6 digits and/or special or wildcard characters. Valid entries are the digits **0** through **9**, **x**, **X**, **\***, and **#**. The **#** character may only be used as the first character.

## Extensions Administered to have an MCT-Control Button

This form assigns the Malicious Call Trace (MCT) feature to specific extensions.

### Administration commands

Use following command to access the Malicious Call Trace form.

| Action | Object               | Qualifier |
|--------|----------------------|-----------|
| change | mct-group-extensions | —         |

### Form instructions

Page 1 of 1

Extensions Administered to have an MCT-Control Button:

|           |           |           |           |           |           |            |
|-----------|-----------|-----------|-----------|-----------|-----------|------------|
| 1: _____  | 16: _____ | 31: _____ | 46: _____ | 61: _____ | 76: _____ | 91: _____  |
| 2: _____  | 17: _____ | 32: _____ | 47: _____ | 62: _____ | 77: _____ | 92: _____  |
| 3: _____  | 18: _____ | 33: _____ | 48: _____ | 63: _____ | 78: _____ | 93: _____  |
| 4: _____  | 19: _____ | 34: _____ | 49: _____ | 64: _____ | 79: _____ | 94: _____  |
| 5: _____  | 20: _____ | 35: _____ | 50: _____ | 65: _____ | 80: _____ | 95: _____  |
| 6: _____  | 21: _____ | 36: _____ | 51: _____ | 66: _____ | 81: _____ | 96: _____  |
| 7: _____  | 22: _____ | 37: _____ | 52: _____ | 67: _____ | 82: _____ | 97: _____  |
| 8: _____  | 23: _____ | 38: _____ | 53: _____ | 68: _____ | 83: _____ | 98: _____  |
| 9: _____  | 24: _____ | 39: _____ | 54: _____ | 69: _____ | 84: _____ | 99: _____  |
| 10: _____ | 25: _____ | 40: _____ | 55: _____ | 70: _____ | 85: _____ | 100: _____ |
| 11: _____ | 26: _____ | 41: _____ | 56: _____ | 71: _____ | 86: _____ |            |
| 12: _____ | 27: _____ | 42: _____ | 57: _____ | 72: _____ | 87: _____ |            |
| 13: _____ | 28: _____ | 43: _____ | 58: _____ | 73: _____ | 88: _____ |            |
| 14: _____ | 29: _____ | 44: _____ | 59: _____ | 74: _____ | 89: _____ |            |
| 15: _____ | 30: _____ | 45: _____ | 60: _____ | 75: _____ | 90: _____ |            |

### Screen 5-38. Malicious Call Trace form (page 1 of 1)

Make assignments as required for the following fields on the form:

- **1-100** — Assign an extension assigned to an extension or attendant that will have an MCT-Control Button.



## External Device Alarm

This form administers External Device Alarm. You need to identify the port, the external device connected to the port (including Product Identifier), and the alarm level assigned to the external device for each alarm connection. You can assign an alarm level of major, minor, or warning.

External Device Alarm Admin must be enabled on the System-Parameters Customer-Options form before External Device Alarm commands can be administered. This is a right-to-use feature; only INADS can administer System-Parameters Customer-Options and the add/change/remove external-device-alarm commands. Execution of the list/display external-device-alarm commands is controlled by the Command Permission set up for each login.

### Administration commands

Use the following commands to administer the External Device Alarm form.

| Action  | Object                  | Qualifier <sup>1</sup>  |
|---------|-------------------------|-------------------------|
| add     | eda-external-device-alm | port                    |
| change  | eda-external-device-alm | port                    |
| display | eda-external-device-alm | port                    |
| list    | eda-external-device-alm | ['print' or 'schedule'] |
| remove  | eda-external-device-alm | port                    |

1. Brackets [ ] indicate the qualifier is optional. Single quotes ( ' ' ) indicate the text inside the quote must be entered exactly as shown or an abbreviated form of the word may be entered.

**⇒ NOTE:**

Port number is the qualifier for add, change, display, and remove commands. The port number is the "port" location used for the alarm connection. Since the 'maintenance circuit pack' alarm connections connect to control carrier circuit packs that are in unnumbered slots, the standard port format cannot be used to designate these alarm connections. The special locations UUmajor and UUminor are used to designate the name of the major or minor maintenance circuit pack alarm connection for cabinet UU. This cabinet number is also assumed for cabinet 01.

**⇒ NOTE:**

The major/minor designation specifies the pair of wires, on the auxiliary connector of the Port Network, not the alarm level associated with the

connection (i.e., the “major” port can be administered as a major, minor, or warning alarm and the “minor” port can be administered as a major, minor, or warning alarm.)

Port is made up of the following information.

| Characters | Meaning        | Value                      |
|------------|----------------|----------------------------|
| 1-2        | Cabinet Number | 1 through Max <sup>1</sup> |
| EITHER     |                |                            |
| 3          | Carrier        | A through E                |
| 4-5        | Slot           | 01-20                      |
| 6-7        | Circuit Number | 01 through 16              |
| OR         |                |                            |
| 3-7        |                | ['major' or 'minor']       |

- 
1. Max is the maximum cabinet number for the system.

## Display Port Command

External device alarm is a new Equipment Type on the Display Port screen. The Alt Name, which you enter on the External Device Alarm Port form, will appear on the Display Port screen in the Identification field.

## Form instructions

---

Make assignments as required for the following fields on each page of the form:

## Page 1 of the External Device Alarm Port form

```
add external-device-alarm 03minor                                SPE A
                        EXTERNAL DEVICE ALARM PORT

                        Port: 03minor
                        Alarm Type: major
                        Alt Name: Audix 2
                        Description: Audix 2 remote equipment room
Project Identifier: 8123456791
                        Building: TSC Building 3 Room 25
                        Address: 8300 E Maplewood Ave Englewood CO 80111
```

Screen 5-39. Example Add External Device Alarm form

```
list eda-external-device-alm                                Page 1 of 1 SPE
A
                        EXTERNAL DEVICE ALARM PORTS

Port      Alarm      Alt      Description      Product
Type      Name
01c1201  minor      UPSI     DC battery discharged      7000000001
01c1202  major      Audix1   Main Audix main equipment  8123456790
01major  minor      UPSI     DC rectifier alarm         7000000001
01minor  minor      UPSI     DC overvoltage alarm       7000000001
03a2101  warning    CC temp  Computer Center Temperature
03a2102  major      CMS2     Call management adjunct    6222222222
03major  major      CMS1     Call management adjunct    6111111111
03minor  minor      Audix2   Audix 2 remote equipment   8123456791
```

Screen 5-40. Example List Eda — External Device Alarm Ports form

- **Port** — Display only. You entered the port number on the command line.
- **Alarm Type** — Assign the alarm level for this external device alarm port. Entries are **major**, **minor** (default), or **warning**.

5 Basic Forms

*External Device Alarm*

Page 5-112

- **Alt Name** — Enter up to a 7 character adjunct short name for this external device alarm. Entries are **a** through **z**, **A** through **Z**, **0** through **9**, or a space to create the name. The name will appear in the `Alt Name` field of several related List, Display, and Test forms. Default is blank.
- **Description** — Enter up to a 40 character adjunct description for the external device alarm. Entries are **a** through **z**, **A** through **Z**, **0** through **9**, or a space to create the name. Default is blank.
- **Product Identifier** — Enter the 10 digit product identifier of the external device alarm. Leading zeroes are significant and retained. If you leave the field blank, alarms associated with the connected adjunct will use the switch product identifier administered on the Change System-Parameters Maintenance screen. Default is blank.
- **Building** — Enter up to a 40 character description of the external device alarm's building location. Entries are **a** through **z**, **A** through **Z**, **0** through **9**, or a space to create the description. Default is blank.
- **Address** — Enter up to a 40 character building address. Entries are **a** through **z**, **A** through **Z**, **0** through **9**, or a space to create the address. Default is blank.

## Feature Access Code

---

This form assigns feature access codes (FACs) that, when dialed, activate or cancel the system features.

### Administration commands

---

Use the following commands to administer the Feature Access Codes form.

| Action  | Object               | Qualifier <sup>1</sup>  |
|---------|----------------------|-------------------------|
| change  | feature-access-codes | —                       |
| display | feature-access-codes | ['print' or 'schedule'] |

- 
1. Brackets [ ] indicate the qualifier is optional. Single quotes ( ' ') indicate the text inside the quote must be entered exactly as shown or an abbreviated form of the word may be entered.

### Form instructions

---

Enter the digits required to access or activate each feature. Feature access codes must conform to your dial plan.

 **NOTE:**

Analog rotary dial sets cannot use the "\*" and "#" symbols.

Page 1 of the form

Page 1 of X

FEATURE ACCESS CODE (FAC)

Abbreviated Dialing List1 Access Code: \_\_\_\_\_

Abbreviated Dialing List2 Access Code: \_\_\_\_\_

Abbreviated Dialing List3 Access Code: \_\_\_\_\_

Abbreviated Dial - Prgm Group List Access Code: \_\_\_\_\_

Announcement Access Code: \_\_\_\_\_

Answer Back Access Code: \_\_\_\_\_

Auto Alternate Routing (AAR) Access Code: \_\_\_\_\_

Auto Route Selection (ARS) Access Code1: \_\_\_\_\_ Access Code 2: \_\_\_\_\_

Automatic Callback Activation: \_\_\_\_\_ Deactivation: \_\_\_\_\_

Call Forwarding Activation Busy/DA: \_\_\_\_\_ All: \_\_\_\_\_ Deactivation: \_\_\_\_\_

Call Park Access Code: \_\_\_\_\_

Call Pickup Access Code: \_\_\_\_\_

CAS Remote Hold/Answer Hold-Unhold Access Code: \_\_\_\_\_

CDR Account Code Access Code: \_\_\_\_\_

Change Coverage: \_\_\_\_\_

Data Origination Access Code: \_\_\_\_\_

Data Privacy Access Code: \_\_\_\_\_

Directed Call Pickup Access Code: \_\_\_\_\_

Emergency Access To Attendant Access Code: \_\_\_\_\_

Extended Call Fwd Activate Busy D/A: \_\_\_\_\_ All: \_\_\_\_\_ Deactivation: \_\_\_\_\_

Screen 5-41. Feature Access Code (FAC) form (page 1 of x)

- **Abbreviated Dialing List1 Access Code** — Used to access AD list 1. 1-4 digit number; \* and # may be used as first digit.
- **Abbreviated Dialing List2 Access Code** — Used to access AD list 2. 1-4 digit number; \* and # may be used as first digit.
- **Abbreviated Dialing List3 Access Code** — Used to access AD list 3. 1-4 digit number; \* and # may be used as first digit.
- **Abbreviated Dial - Prgm Group List Access Code** — Used to enter a group list from a voice terminal. 1-4 digit number; \* and # may be used as first digit.
- **Announcement Access Code** — Used to record announcements. 1-4 digit number; \* and # may be used as first digit.
- **Answer Back Access Code** — Used to retrieve parked calls. 1-4 digit number; \* and # may be used as first digit.
- **Auto Alternate Routing (AAR) Access Code** — Used to access AAR. 1-4 digit number; \* and # may be used as first digit.
- **Auto Route Selection (ARS) Access Code1** — Used to access ARS. 1-4 digit number; \* and # may be used as first digit.
- **(ARS) Access Code 2** — Also used to access ARS. 1-4 digit number; \* and # may be used as first digit.

- **Automatic Callback Activation** — Used to activate ACB. 1–4 digit number; \* and # may be used as first digit.
  - **Deactivation** — Used to deactivate ACB. 1-4 digit number; \* and # may be used as first digit.
- **Call Forwarding Activation Busy/DA** — Used to forward calls to an administered number if the user is busy or does not answer. 1–4 digit number; \* and # may be used as first digit.
  - **All** — Used to forward calls to an administered number for all calls. 1–4 digit number; \* and # may be used as first digit.
  - **Deactivation** — Used to deactivate call forwarding. 1–4 digit number; \* and # may be used as first digit.
- **Call Park Access Code** — Used to park an active call, which can then be retrieved from a different station using the answer back access code. 1–4 digit number; \* and # may be used as first digit.
- **Call Pickup Access Code** — Used to answer a call directed to a pickup group. 1–4 digit number; \* and # may be used as first digit.
- **CAS Remote Hold/Answer Hold-Unhold Access Code** — 1–4 digit number; \* and # may be used as first digit.
- **CDR Account Code Access Code** — Used prior to entering an account code for CDR purposes. 1–4 digit number; \* and # may be used as first digit.
- **Change Coverage** — Used to change a coverage path from a voice terminal or remote station. 1–4 digit number; \* and # may be used as first digit.
- **Data Origination Access Code** — Used to originate a data call from a voice station. 1–4 digit number; \* and # may be used as first digit.
- **Data Privacy Access Code** — Used to isolate a data call from call waiting or other interruptions. 1–4 digit number; \* and # may be used as first digit.
- **Directed Call Pickup Access Code** — Used to establish directed call pickup. 1–4 digit number; \* and # may be used as first digit.
- **Emergency Access To Attendant Access Code** — Used to gain access to the attendant in an emergency situation. Such calls alert as emergency calls. 1–4 digit number; \* and # may be used as first digit.

This field cannot be used if the `Emergency Access to Attendant` field is not enabled on the `System-Parameters Customer-Options` form.
- **Extended Call Fwd Activate Busy D/A** — Used to activate call forwarding from a voice terminal or remote location. 1–4 digit number; \* and # may be used as first digit.
- **Extended Call Fwd Activate All** — Used to activate call forwarding from a voice terminal or remote location. 1–4 digit number; \* and # may be used as first digit.

- **Extended Call Fwd Deactivation** — Used to deactivate call forwarding from a voice terminal or remote location 1–4 digit number; \* and # may be used as first digit.



**NOTE:**

Users with blank Station Security Codes cannot use the following FACs:

- Extended Call Forward All Activate
- Extended Call Forward Busy/Don't Answer Activate
- Extended Call Forward Deactivate
- Change Coverage

### Implementation notes

---

The Emergency Access to Attendant Access Code field displays when the optional Emergency Access to the Attendant field has been enabled on the System-Parameters Customer-Options form.

Call Park Access Code — Do not administer to have the same first digit as another feature access code that is longer in length.

### Page 2 of the form

Page 2 of X

FEATURE ACCESS CODE (FAC)

|   |                  |
|---|------------------|
| Facility Test Calls Access Code:                |                  |
| Flash Access Code:                              |                  |
| Group Control Restrict Activation:              | Deactivation:    |
| Hunt Group Busy Activation:                     | Deactivation:    |
| ISDN Access Code:                               |                  |
| Last Number Dialed Access Code:                 |                  |
| Leave Word Calling Message Retrieval Lock:      |                  |
| Leave Word Calling Message Retrieval Unlock:    |                  |
| Leave Word Calling Send A Message:              |                  |
| Leave Word Calling Cancel A Message:            |                  |
| Malicious Call Trace Activation:                | Deactivation:    |
| PASTE (Display PBX data on Phone) Access Code:  |                  |
| Per Call CPN Blocking Code Access Code: _____   |                  |
| Per Call CPN Unblocking Code Access Code: _____ |                  |
| Personal Station Access (PSA) Associate Code:   | Dissociate Code: |
| Print Messages Access Code:                     |                  |
| Priority Calling Access Code:                   |                  |
| Program Access Code:                            |                  |
| Refresh Terminal Parameters Access Code:        |                  |
| Send All Calls Activation:                      | Deactivation:    |



- **Facility Test Calls Access Code** — Used to place activate a facility test call. 1–4 digit number; \* and # may be used as first digit.



**NOTE:**

To ensure the security of your system, leave `Facility Test Calls Access Code` blank except when actually testing trunks.

- **Flash Access Code** — Used to generate trunk flash. 1-4 digit number; \* and # may be used as first digit.
- **Group Control Restrict Activation** —
- **Group Control Restrict Deactivation** —
- **Hunt Group Busy Activation/Deactivation** —
- **ISDN Access Code** — Used to place an ISDN call without using ARS, AAR, or UDP. Enter a 1- to 4-digit number; \* and # may be used as the first digit.
- **Last Number Dialed Access Code** — Used to redial the last number dialed from this station.
- **Leave Word Calling Message Retrieval Lock** — Enter the unique code to be dialed to lock the display module on voice terminals. Valid entries are a 1- to 4-character string consisting of the characters 0 through 9; \* and # may be used as the first character. (The lock function activates at a voice terminal by dialing this system-wide lock access code. This prevents unauthorized users from displaying, canceling, or deleting messages associated with the voice terminal.) The `Lock Messages` field on the Station form also must be enabled.
- **Leave Word Calling Message Retrieval Unlock** — Enter the unique code to be dialed to unlock a voice terminal's display module. Valid entries are a 1- to 4-character string consisting of the characters 0 through 9; \* and # may be used as the first character. The lock function is canceled at the voice terminal by dialing this unlock FAC followed by the SCC.
- **Leave Word Calling Send A Message** — Enter the unique code to be dialed to send a message. Valid entries are a 1- to 4-character string consisting of the characters 0 through 9; \* and # may be used as the first character.
- **Leave Word Calling Cancel A Message** — Enter the unique code to be dialed to cancel a message. Valid entries are a 1- to 4-character string consisting of the characters 0 through 9; \* and # may be used as the first character.
- **Malicious Call Trace Activation** — Used to activate a trace on a malicious call.
- **PASTE (Display PBX data on Phone) Access Code** —
- **Per Call CPN Blocking Code Access Code** — Enter 1 to 4 digit number and \* and # may be used as the first digit. Default is blank.

5 Basic Forms

Feature Access Code

- **Per Call CPN Unblocking Code Access Code**— Enter 1 to 4 digit number and \* and # may be used as the first digit. Default is blank.
- **Personal Station Access (PSA) Associate Code** — Enter the unique code the user will dial to activate the Personal Station Access feature at a terminal. Valid entries are a 1- to 4-character string consisting of the digits 0 through 9; \* and # may be used as the first character.
- **Dissociate Code** — Enter the code the user will dial to dissociate the PSA feature at a terminal. Valid entries are a 1- to 4-character string consisting of the digits 0 through 9; \* and # may be used as the first character. You cannot provide either code until `Personal Station Access (PSA)` on the System Parameters Customer-Options form is `y`.
- **Print Messages Access Code** —
- **Program Access Code** —
- **Refresh Terminal Parameters Access Code** —
- **Send All Calls Activation/Deactivation** — Used to activate or deactivate sending all calls to coverage with minimal or no alerting at the station.

Page 3 of the form

Page 3 of X

FEATURE ACCESS CODE (FAC)

Station Security Code Change Access Code: \_\_\_\_\_

Terminal Dial-up Test Access Code: \_\_\_\_\_

Terminal Translation Initialization Merge Code: \_\_\_\_\_ Separation Code: \_\_\_\_\_

Transfer to AUDIX Access Code: \_\_\_\_\_

Trunk Answer Any Station Access Code: \_\_\_\_\_

User Control Restrict Activation: \_\_\_\_\_ Deactivation: \_\_\_\_\_

Voice Coverage Message Retrieval Access Code: \_\_\_\_\_

Voice Principal Message Retrieval Access Code: \_\_\_\_\_

Screen 5-43. Feature Access Code (FAC) form (page 3 of x)

- **Station Security Code Change Access Code** — Enter the code the user must dial to change their Station Security Code. Valid entries are a 1- to 4-character string consisting of the digits 0 through 9; \* and # may be used as the first character. The SCC must be administered before the user can change it using this FAC. That is, a user cannot change a blank SCC.
- **Terminal Dial-Up Test Access Code** —
- **Terminal Translation Initialization Merge Code** — Enter the digits that must be dialed to install (merge) a station without losing any of its previous feature settings. The Terminal Translation Initialization Separation Code must have been used, or the station made AWOH, when the voice terminal was removed from its former location in order for the Terminal Translation Initialization Merge Code to be effective.

- **Terminal Translation Initialization Separation Code** — Enter the digits that must be dialed to remove (separate) a station from a location without losing any of its feature settings.
- **Transfer to AUDIX Access Code** — Enter the digits that must be dialed to allow coverage to transfer the caller to the original call recipient's AUDIX mail where the caller can leave a message. Valid entries are a 1- to 4-digit number consisting of the digits 0 through 9; \* and # may be used as the first digit. Default is blank.
- **Trunk Answer Any Station Access Code** —
- **User Control Restrict Activation/Deactivation** —
- **Voice Coverage Message Retrieval Access Code** — Allows users to retrieve voice coverage messages via a digital display module.
- **Voice Principal Message Retrieval Access Code** —

### Implementation note

---

Transfer into AUDIX Access Code — Do not administer to have the same first digit as another feature access code that is longer in length.

### Page 4 of the form

Page 4 of X

FEATURE ACCESS CODE (FAC)

Automatic Call Distribution Features

After Call Work Access Code: \_\_\_

    Assist Access Code: \_\_\_

    Auto-In Access Code: \_\_\_

    Aux Work Access Code: \_\_\_

    Login Access Code: \_\_\_

    Logout Access Code: \_\_\_

    Manual-In Access Code: \_\_\_

Service Observing Listen Only Access Code: \_\_\_

Service Observing Listen/Talk Access Code: \_\_\_

    Add Agent Skill Access Code: \_\_\_

    Remove Agent Skill Access Code: \_\_\_

Call Vectoring/Call Prompting Features

    Converse Data Return Code: \_\_\_

Screen 5-44. Feature Access Code (FAC) form (page 4 of x)

The next eleven fields are only available for administration if the ACD field (Automatic Call Distribution) has been enabled on the System-Parameters Customer-Options form.

 NOTE:

These fields will also display if `Vectoring (Basic)` and `Vectoring (Prompting)` have been enabled on the System-Parameters Customer-Options form; however, they will only be administrable if ACD has been enabled.

- **After Call Work Access Code** — Enter the code the agent must dial when the agent will be performing work-related ACD activities.
- **Assist Access Code** — Enter the digit the agent must dial to request assistance from the split supervisor.
- **Auto-In Access Code** — Enter the code the agent must dial to become automatically available to receive another ACD call each time a call is released.
- **Aux Work Access Code** — Enter the code the agent must dial when the agent will be performing non-ACD activities.
- **Login Access Code** — Enter the code the agent must dial to gain access to the ACD functions. This is a system-wide code for all ACD agents.
- **Logout Access Code** — Enter the logout code the agent must enter to exit ACD. This is a system-wide logout code for all ACD agents.
- **Manual-In Access Code** — Enter the code the agent must dial to receive a single, new ACD call upon the completion of an ACD call.

The following two fields appear only if `Service Observing (Remote/By FAC)` on the System Parameters Customer-Options form is **y**.

- **Service Observing Listen Only Access Code** — Enter the code that must be dialed to allow a station with Service Observing permission (COR) to listen to other agent ACD calls without being heard on the ACD call.
- **Service Observing Listen/Talk Access Code** — Enter the code that must be dialed to allow a station with Service Observing permission (COR) to both listen and be heard on an ACD call.

The following two fields appear only if `Expert Agent Selection (EAS) Enabled` is optioned on the Feature-Related System-Parameters form.

- **Add Agent Skill Access Code** — Enter the digits an agent must dial to be able to add a skill to their current skill set.
- **Remove Agent Skill Access Code** — Enter the digits an agent must dial to be able to remove a skill from their current skill set.

The next field is available only if `Vectoring (Basic)` and `Vectoring (Prompting)` have been enabled on the System-Parameters Customer-Options form.

- **Converse Data Return Code** — Enter the access code the CONVERSANT must outpulse prior to outpulsing the digits being returned to the system. This FAC must match the code administered on CONVERSANT.

## Implementation notes

---

The Call Vectoring/Call Prompting features only display if Vectoring (Basic) and Vectoring (Prompting) have been enabled on the System-Parameters Customer-Options form.

## Page 5 of the form

Page 5 of X

FEATURE ACCESS CODE (FAC)

Hospitality Features

Automatic Wakeup Call Access Code: \_\_\_\_\_

Housekeeping Status (Client Room) Access Code: \_\_\_\_\_

Housekeeping Status (Client Room) Access Code: \_\_\_\_\_

Housekeeping Status (Client Room) Access Code: \_\_\_\_\_

Housekeeping Status (Client Room) Access Code: \_\_\_\_\_

Housekeeping Status (Client Room) Access Code: \_\_\_\_\_

Housekeeping Status (Client Room) Access Code: \_\_\_\_\_

Housekeeping Status (Station) Access Code: \_\_\_\_\_

Housekeeping Status (Station) Access Code: \_\_\_\_\_

Housekeeping Status (Station) Access Code: \_\_\_\_\_

Housekeeping Status (Station) Access Code: \_\_\_\_\_

Verify Wakeup Announcement Access Code: \_\_\_\_\_

Voice Do Not Disturb Access Code: \_\_\_\_\_

## Screen 5-45. Feature Access Code (FAC) form (page 5 of xS)

The access codes assigned to the Housekeeping Status (Client Room) Access Code and Housekeeping Status (Station) Access Code fields are assigned to reflect the customer requirements. These codes are transmitted to the Property Management System (PMS) for processing.

The next five fields display only if Hospitality (Basic) has been enabled on the System-Parameters Customer-Options form.

- **Automatic Wakeup Call Access Code** — Enter the access code the user must dial to schedule or cancel a wakeup call.
- **Housekeeping Status (Client Room) Access Code** — Enter the access code the housekeeper dials from the client's room to provide room status. There are six codes.

5 Basic Forms

Feature Access Code

Page 5-122

- **Housekeeping Status (Station) Access Code** — Enter the access code the housekeeper must dial to provide room status. This access code must be dialed from designated voice terminals. There are four codes.
- **Verify Wakeup Announcement Access Code** — Enter the access code the user can dial to verify a wakeup announcement.
- **Voice Do Not Disturb Access Code** — Enter the access code the user must dial to enter or cancel a do not disturb request without using a display — through the use of voice prompting.

Page 6 of the form

Page 6 of 6

FEATURE ACCESS CODE (FAC)

Multimedia Features

Multimedia Data Conference Access Code: \_\_\_\_\_

Screen 5-46. Feature Access Code (FAC) form (page 5 of 5)

- **Multimedia Data Conference Access Code** — Enter the access code the user must dial to initiate a multimedia data collaboration session. This code only applies if Multimedia Call Handling is enabled.

## Feature-Related System Parameters

---

This form implements system parameters associated with various System features.

### Administration commands

---

Use the following commands to administer the Feature-Related System Parameters form.

| Action  | Object                     | Qualifier <sup>1</sup>  |
|---------|----------------------------|-------------------------|
| change  | system-parameters features | —                       |
| display | system-parameters features | ['print' or 'schedule'] |

- 
1. Brackets [ ] indicate the qualifier is optional. Single quotes ( ' ' ) indicate the text inside the quote must be entered exactly as shown or an abbreviated form of the word may be entered.

### Form instructions

---

Make assignments as required for the following fields on each page of the form:

Page 1 of the form

Page 1 of 8

FEATURE-RELATED SYSTEM PARAMETERS

Trunk-to-Trunk Transfer? none

Coverage Subsequent Redirection/CFWD No Answer Interval: 3\_  
 Coverage - Caller Response Interval (seconds): 4\_  
     Keep Held SBA at Coverage Point? y\_  
 Automatic Callback - No Answer Timeout Interval (rings): 4\_  
     Call Park Timeout Interval (minutes): 10  
 Off-Premises Tone Detect Timeout Interval (seconds): 20\_  
     AAR/ARS Dial Tone Required? y  
     Music/Tone On Hold: music Port: \_\_\_\_\_  
 Music (or Silence) On Transferred Trunk Calls: all  
     DID/Tie/ISDN Intercept Treatment: attd  
     Messaging Service Adjunct (MSA) Connected? y  
 Internal Automatic Answer for Attendant Extended Calls? y  
     Automatic Circuit Assurance (ACA) Enabled? y  
     ACA Referral Calls: local  
     ACA Referral Destination: \_\_\_\_\_  
 ACA Short Holding Time Originating Extension: \_\_\_\_\_  
 ACA Long Holding Time Originating Extension: \_\_\_\_\_

Abbreviated Dial Programming by Assigned Lists:  
 Auto Abbreviated/Delayed Transition Interval(rings):

Screen 5-47. Feature-Related System Parameters form (page 1 of 8)

- **Trunk-to-Trunk Transfer** — Enter **all** to enable all trunk-to-trunk transfers. This allows voice terminal users to set up trunk-to-trunk transfer, go on-hook without disconnecting the call, and forward the call to a remote location. Enter **restricted** (restricted public) to restrict all public trunks (CO, WATS, FX, CPE, DID, and DIOD). Enter **none** (default) to restrict all trunks (except CAS and DCS) from being transferred.

 **NOTE:**

Regulations in some countries control the settings for this field. See your Lucent Technologies representative for assistance.

- **Coverage Subsequent Redirection/CFWD No Answer Interval** — Enter the number of times (**1** through **99**) a voice terminal in a Call Coverage path rings before the call routes to the next coverage point. A typical (recommended) interval is 2 to 3 rings. This value also is used by the Call Forward Busy/Don't Answer field to control the number of rings before the call is forwarded. Default is **3**.
- **Coverage — Caller Response Interval (seconds)** — Enter the time in seconds (**0** through **10**) the caller (internal caller only) has before the call redirects to the called party's first coverage point. The calling party can either hang up, use Leave Word Calling, or press the Go to Cover button during this time interval. Default is **4**.



- **Keep Held SBA at Coverage Point** — Enter **y** (default) to keep a simulated bridged appearance on hold at the coverage point when the principal enters the call; otherwise, enter **n**. If the bridged appearance is kept, the covering user then may enter the call along with the principal and the calling party.
- **Automatic Callback — No Answer Timeout Interval (rings)** — Enter the number of times the callback call rings at the calling station before the callback call is canceled. Valid entries are **2** through **9**. Default is **4**.
- **Call Park Timeout Interval (minutes)** — Enter the number of minutes (**1** through **90**) a call remains parked before it cancels. Default is **10**.
- **Off-Premises Tone Detect Timeout Interval (seconds)** — Enter the number of seconds (**5** through **25**) a call progress tone receiver (CPTTR) tries to detect dial tone from a trunk during dialing. Once the time-out interval occurs, the call either outpulses on the trunk or gets intercept treatment depending on the setting of the `Outpulse Without Tone` field on page 6 of this form. The default is **20**.
- **AAR/ARS Dial Tone Required** — Enter **y** (default) to indicate a second dial tone is to be given to the calling party on a incoming tie or DID trunk call that is to be routed via AAR/ARS. A second dial tone provides feedback to the user that additional dialing can occur.
- **Music/Tone on Hold** — Enter **music** or **tone** to indicate what a caller hears while on hold; enter **none** (default) for silence. This field does not appear if `Tenant Partitioning` is **y** on the System-Parameters Customer-Options form.

 **NOTE:**

If you use equipment that rebroadcasts music or other copyrighted materials, you may be required to obtain a copyright license from, or pay fees to, a third party such as the American Society of Composers, Artists, and Producers (ASCAP) or Broadcast Music Incorporated (BMI). You can purchase a Magic OnHold<sup>®</sup> system, which does not require such a license, from Lucent Technologies.

- **Port** — Appears when `Music/Tone on Hold` is **music**. Indicates the port number that provides Music-on-Hold access. This requires a port on a TN763 Auxiliary Trunk circuit pack or any supported Analog Line circuit pack. The entry breaks down as follows:

| Characters | Meaning        | Value         |
|------------|----------------|---------------|
| 1-2        | Cabinet Number | 01 through 22 |
|            |                | 01 through 03 |
| 3          | Carrier        | A through E   |

| Characters | Meaning        | Value                          |
|------------|----------------|--------------------------------|
| 4-5        | Slot Number    | 01 through 20                  |
| 6-7        | Circuit Number | 01 through 04 (Aux Trunk Port) |
|            |                | 01 through 16 (Analog Port)    |

- **Music (or Silence) On Transferred Trunk Calls** — Enter **all** to allow all transferred trunk calls to receive music until the call is answered if the Music-on-Hold feature is available. Enter **n** (default) if trunk callers are to hear music (or silence if Music-on-Hold is not administered) while waiting to be transferred, and then ringback as soon as the transfer is completed till the call is answered. Enter **call-wait** if trunk calls transferred to stations that require the call to wait hear music (if administered); all other transferred trunk calls receive ringback tone.
- **DID/Tie/ISDN Intercept Treatment** — Enter a recorded announcement extension number or **attd** (default) for the attendant to be used for intercept of invalid Direct Inward Dialing and/or tie trunk calls.

 **NOTE:**

For system security, Lucent recommends entering "**attd**" in this field. This routes intercept calls to the attendant and, if the attendant receives several of these, they will know a problem exists.

- **Messaging Service Adjunct (MSA) Connected** — Enter **y** if AUDIX Voice Power MSA is connected to the system. Default is **n**.
- **Internal Automatic Answer for Attendant Extended Calls** — Enter "y" to enable IAA for attendant extended calls. This only applies to the 7313H through 7317H (MERLIN) voice terminals as well as speaker equipped 73XX-series (ATL) hybrid voice terminals and digital voice terminals (except BRI) with a headphone or speaker capability. Default is **n**.
- **Automatic Circuit Assurance (ACA) Enabled** — Must have an "aca-halt" button administered on the user's station. Enter **y** if ACA measurements will be taken; otherwise, enter **n** (default). If you enable this feature, complete the following ACA-related fields.
- **ACA Referral Calls** — (Only displays when ACA Enabled is **y**.) Enter **local** (default), **primary**, or **remote** to indicate where ACA referral calls generate. Local referral calls generate on and for the local switch. Primary referral calls generate on the local switch for remote switches as well as the local switch. Remote referral calls generate at another switch in a DCS network. In this case, the remote node number must also be entered. The remote node number is the same node number as defined on the Dial Plan form. Also, ACA button status transmits to other switches when in a DCS network.

- **ACA Referral Destination** — Enter the extension on the local switch that is to receive the ACA referral call or enter **attd** for attendant. The specified extension should be equipped with a display module. This field only displays if `ACA Referral Calls` is **local** or **primary**.
- **ACA Short Holding Time Originating Extension and ACA Long Holding Time Originating Extension** — Enter an unassigned extension number in each field. Do not use the same extension number for both fields. The specified extensions are assigned automatically by the system when the form is submitted. These fields only display if `ACA Referral Calls` is **local** or **primary**.
- **ACA Remote PBX Identification** — Enter a number from **1** through **63** to identify the switch in a DCS network that makes the referral call. This field only displays if `ACA Referral Calls` is **remote**. Do not define the remote PBX identified in this field as **local** on the system's Dial Plan form.
- **Auto Abbreviated/Delayed Interval (rings)** — Enter the number of rings (**1-16**) before an automatic abbreviated delayed transition is triggered for a call.
- **Abbreviated Dial Programming by Assigned Lists** — Enter **y** to allow programming by station's assigned list. Enter **n** (default) if using Program Access code to indicate which personal list to be programmed.

## Implementation notes

---

If `Automatic Circuit Assurance (ACA) Enabled` is **n**, associated ACA fields will not display.

Page 2 of the form

```

                                     Page 2 of 8
                FEATURE-RELATED SYSTEM PARAMETERS

LEAVE WORD CALLING PARAMETERS
Maximum Number of Messages Per Station (when MSA not in service): 10_
Stations with System-wide Retrieval Permission (enter extension)
  1: 34430   3: attd_   5: _____  7: _____  9: _____
  2: 34412   4: _____  6: _____  8: _____ 10: _____
WARNING!   SEE USER DOCUMENTATION BEFORE CHANGING TTI STATE
          Terminal Translation Initialization (TTI) Enabled? y
          TTI State: voice           TTI Security Code: _____
          Record PSA/TTI Transactions in History Log? _

          Prohibit Bridging Onto Calls with Data Privacy? _
          Enhanced Abbreviated Dial Length (3 or 4)? _
          Call Forward Override? _
External Coverage Treatment for Transferred Incoming Calls? _
          Coverage of Calls Redirected Off-Net Enabled? _
          Default Multimedia Outgoing Trunk Parameter Selection: 2x64
WIRELESS PARAMETERS
Radio Controllers with Download Server Permission (enter board location)
  1: ___  2: ___  3: ___  4: ___  5: ___
    
```

Screen 5-48. Feature-Related System Parameters form (page 2 of 8)

- **Maximum Number of Messages Per Station (when MSA not in service)** — Enter the maximum number of LWC Messages that can be stored by the system for a voice terminal at a given time. Default is **10**.
- **Stations With System-wide Retrieval Permission (enter extension)** — Enter up to 10 voice terminal extension numbers that can retrieve LWC Messages for all other voice terminals. A VDN extension is not allowed. An entry of **attd** gives retrieval permission to all attendants.
- **Terminal Translation Initialization (TTI) Enabled** — Terminal Translation Initialization (TTI) must be enabled on the System-Parameters Customer-Options form before the TTI fields can be administered. Enter **y** to start a background maintenance task to generate TTI port translations for unadministered ports on TTI-supported circuit packs. Enter **n** to remove existing TTI port translations and make sure no new TTI port translations will be generated.

 **CAUTION:**

*Changing the TTI Enable field from **n** to **y** or from **y** to **n** triggers a background maintenance task that either generates (when changed to **y**) or removes (when changed to **n**) TTI port translation for unadministered ports in the system.*

- **TTI State** — Enter **data**, **resume**, **suspend**, or **voice** (default). The value of this field determines what type of TTI default port translation is generated for unadministered digital ports. Entering **suspend** allows any current generation or removal of TTI port translations to be halted and access to TTI will also be denied. Entering **resume** allows the TTI state to return to what it was before TTI was manually suspended. Enter **voice** for the Personal Station Access feature. This field displays only when Terminal Translation Initialization (TTI) Enabled is **y**.
- **TTI Security Code** — The TTI security code is a 1- to 7-digit code that TTI users must enter when accessing TTI from their terminals. (It is also known as the TTI authorization code but is not the same as system authorization codes.) This field displays only when Terminal Translation Initialization (TTI) Enabled is **y**.
- **Record PSA/TTI Transactions in History Log** — If **y** (default), TTI and PSA transactions record in the history log. You access these transactions via the List History command. This field appears only if Terminal Translation Initialization (TTI) Enabled is **y**.
- **Prohibit Bridging Onto Calls with Data Privacy** — Enter **y** to protect calls from bridge-on by any party, including Service Observing, Intrusion, Verify, and Bridging. Default is **n**.
- **Enhanced Abbreviated Dial Length (3 or 4)** — A value of **3** (default) makes 1000 Enhanced List entries available to the administrator; a value of **4** makes 10,000 entries available. The administrator may not be able to use all entry slots because of system capacity constraints.
- **Call Forward Override** — This field controls Call Forward Override with the Call Forwarding — All Calls feature. Set to **y** to allow the user of the forwarded-to station to override Call Forward — All Calls. This allows the user to initiate or transfer a call to the forwarded-from station.
- **External Coverage Treatment for Transferred Incoming Calls** — If set to **y**, then transferred calls have 2 rings (external) when they go to coverage. If set to **n**, the calls have 1 ring (internal) when they go to coverage.
- **Coverage of Calls Redirected Off-Net Enabled** — Set to **y** to allow further processing of calls redirected off-net by call forwarding or call coverage features. Set Coverage of Calls Redirected Off-Net on the System Parameters Customer-Options form to **y** to administer this field. Default is **n**.
- **Default Multimedia Outgoing Trunk Parameter Selection** — Sets default parameter for bandwidth and bearer for all video calls. Valid entries are **1x56**, **2x56**, **1x64**, and **2x64** (default).

## Page 3 of the form

Page 3 of 8

FEATURE-RELATED SYSTEM PARAMETERS

Reserved Slots for Attendant Priority Queue: 5\_  
Time Before Off-Hook Alert: 10\_\_  
Emergency Access Redirection Extension: \_\_\_\_  
Number of Emergency Calls Allowed in Attendant Queue: \_\_  
Call Pickup Alerting? n  
Temporary Bridged Appearance on Call Pickup? y  
Call Pickup on Intercom Calls? y  
Directed Call Pickup? n  
Deluxe Paging and Call Park Timeout to Originator? n  
Controlled Outward Toll Restriction Intercept Treatment: tone \_\_\_\_  
Controlled Termination Restriction (Do Not Disturb): tone \_\_\_\_  
Controlled Station to Station Restriction: tone \_\_\_\_

AUTHORIZATION CODE PARAMETERS

Authorization Code Enabled? y  
Authorization Code Length: 7  
Authorization Code Cancellation Symbol? #  
Attendant Time Out Flag? n  
Display Authorization Code? \_  
Display Authorization Code? y

### Screen 5-49. Feature-Related System Parameters form (page 3 of 8)

- **Reserved Slots for Attendant Priority Queue** — Enter the number of calls that can go in to the emergency queue. Default is **5**.
- **Time Before Off-Hook Alert** — Enter the time in seconds that a voice terminal with an Off-Hook Alert Class of Service can remain off-hook (after intercept tone has started) before an emergency call is sent to the attendant. Valid entries are 1 to 3000 seconds. Default is **10**.
- **Emergency Access Redirection Extension** — Enter the assigned extension number (can be a VDN) where emergency queue overflow will redirect.
- **Number of Emergency Calls Allowed in Attendant Queue** — Enter the number of calls allowed in the attendant queue before additional calls are routed to the backup extension.
- **Call Pickup Alerting** — Entering **y** enables the Call Pickup Alerting feature on a system-wide basis. This provides pickup group members with a visual indication on the Call Pickup status lamp of calls eligible to be answered via Call Pickup. Default is **n**.
- **Temporary Bridged Appearance on Call Pickup** — Enter **y** (default) to allow a temporary bridged appearance for calls answered with the Call Pickup or Directed Call Pickup features. This field controls this capability on a system-wide basis. Enter **n** to prevent the temporary bridged appearance of calls answered with these features.

- **Call Pickup on Intercom Calls** — Enter **y** (default) to allow a user's or Agent LoginID's call, ringing as an intercom call, to be picked up using the `Call Pickup` or `Directed Call Pickup` features. This field controls the use of this feature throughout the system. Enter **n** to prevent the use of these features to pickup an intercom call.
- **Directed Call Pickup** — Enter **y** to allow use of the `Directed Call Pickup` feature across the system. Enter **n** (default) to prevent feature use. Feature use by individual stations, attendants, or EAS agents can be controlled by COR.
- **Deluxe Paging and Call Park Timeout to Originator** — Enter **y** to enable the `Loudspeaker Paging - Deluxe` feature that essentially integrates the `Loudspeaker Paging` and `Call Park` features. All parked calls that time out (not answered by paged party) return to the parking party. Enter **n** (default) to enable the `Loudspeaker Paging` feature. Paged calls that are to be parked require separate activation of the `Call Park` feature. All parked calls that time out return to the attendant.
- **Controlled Outward Restriction Intercept Treatment** — Enter the type of intercept treatment the caller receives when the call is outward restricted. Valid entries are **announcement**, **attendant**, **coverage**, **extension** (may not be a VDN extension), or **tone** (default). If **announcement** or **extension** is entered, enter the extension number for the announcement or extension in an associated field.
- **Controlled Termination Restriction (Do Not Disturb)** — Enter the type of intercept treatment the caller receives when the call is placed to a termination restricted voice terminal. Valid entries are **announcement**, **attendant**, **cover**, **extension** (may not be a VDN extension), or **tone** (default). If **announcement** or **extension** is entered, complete an associated extension number field.
- **Controlled Station-to-Station Restriction** — Enter the type of intercept treatment the caller receives when the call is placed to a restricted voice terminal. Valid entries are **announcement**, **attendant**, **extension** (may not be a VDN extension), or **tone** (default). If announcement or extension is entered, an associated extension number field displays. Enter the extension of the restricted voice terminal in the field.
- **Authorization Codes Enabled** — Enter **y** to enable the `Authorization Codes` feature on a systemwide basis. This field cannot be administered if `Authorization Codes` is not enabled on the `System-Parameters Customer-Options` form. Default is **n**.



**NOTE:**

To maintain system security, Lucent recommends that `Authorization Codes` be used.

- **Authorization Code Length** — Enter a number from **4** through **7** (default) that defines the number of digits (length) in the `Authorization Code` field. This field only displays and must be completed if `Authorization Codes Enabled` is **y**. This is the number of digits that must be assigned to the `Authorization Code (AC)` field on the `Authorization Code` form.



**NOTE:**

You enhance your system's security by using the maximum length for your authorization code.

- **Authorization Code Cancellation Symbol** — Enter the symbol a caller must dial to cancel the 10-second wait period during which the user can enter an authorization code. Enter the cancellation code **#** (default) if the main and tandem switches are both the same type of switch. Enter the cancellation code **1** if an Lucent Technologies System 85 or DIMENSION PBX switch is part of the complex/network. This field only displays when `Authorization Code` is **y**.
- **Attendant Time Out Flag** — Enter **y** if a call is to be routed to the attendant if the caller does not dial an authorization code within 10 seconds or dials an invalid authorization code. If this field is not enabled, the caller receives Intercept tone. This flag affects only remote users or incoming calls over trunks requiring an authorization code. This field only displays if `Authorization Codes Enabled` is **y**. Default is **n**.
- **Display Authorization Code** — Enter "**y**" to allow authorization code digits to display on the set during the dialing. Enter "**n**" if these digits should not display. This field applies only to DCP, not to BRI or hybrid sets.



**NOTE:**

To enhance your system's security, `Display Authorization Code` should be set to **n**.



## Page 4 of the form

Page 4 of 8

FEATURE-RELATED SYSTEM PARAMETERS

SYSTEM PRINTER PARAMETERS  
System Printer Extension: \_\_\_\_\_ Lines Per Page: 60  
EIA Device Bit Rate: 9600

SYSTEM-WIDE PARAMETERS  
Switch Name: \_\_\_\_\_

MALICIOUS CALL TRACE PARAMETERS  
Apply MCT Warning Tone? n MCT Voice Recorder Trunk Group: \_\_\_\_

SEND ALL CALLS OPTIONS  
Send All Calls Applies to: station  
Auto Inspect on Send All Calls? n

UNIVERSAL CALL ID  
Create Universal Call ID (UCID)? n UCID Network Node ID: \_\_\_\_

### Screen 5-50. Feature-Related System Parameters form (page 4 of 8)

System Printer Parameters (printer dedicated to support the Report Scheduler feature):

- **System Printer Extension** — Enter either the data module extension number associated with the System printer or enter **eia** if the DCE jack is used to interface the printer.



**NOTE:**

The **eia** option is not available for R5r and later configurations.

- **Lines Per Page** — Enter the number of lines per page required for the report. Valid entries are **24** through **132**. Default is **60**.
- **EIA Device Bit Rate** — This field is not displayed for R5r and later configurations. Enter **1200**, **2400**, **4800**, or **9600** (default) per the required printer speed setting.

System-Wide Parameters:

- **Switch Name** — Enter the name of the switch.

Malicious Call Trace Parameters:

- **Apply MCT Warning Tone** — Enter **y** to provide an audible tone to the controlling station when an MCT recorder is actively recording a malicious call. Default is **n**.
- **MCT Voice Recorder Trunk Group** — Assign the trunk group for MCT voice recorders. Default is blank.

Send All Calls Options:

- **Send All Calls Applies to** — If set to **station** (default), any call to that station, regardless of the number dialed, causes calls to that station's own extension to be sent immediately to Coverage, or causes calls to different extensions assigned to the station as bridged appearances to become Ring-Ping notification if `Redirect Notification` field is **y**. When set to **extension**, only the calls sent to that extension are placed to coverage.
- **Auto Inspect on Send All Calls** — If set to **n** (default), you are not guaranteed a Calling Party display for calls sent directly to Coverage by the Send-All-Calls feature. If set to **y**, allows you to be presented automatically with Calling Party information for calls which are silently alerting their station because of the Send-All-Calls feature.

Universal Call ID (UCID):

- **Create Universal Call ID (UCID)** — If set to **n** (default), the DEFINITY will not generate a UCID for any call. If set to **y**, DEFINITY will generate UCID for each call when necessary.
- **UCID Network Node ID** — Enter a number unique to the switch in a network of switches. This number is an important part of the UCID tag and must be unique to the switch. Valid entries are a number between **1 - 32767** or blank.

Page 5 of the form

Page 5 of 8

FEATURE-RELATED SYSTEM PARAMETERS

```

Public Network Trunks on Conference Call: 5           Auto Start? n
Conference Parties with Public Network Trunks: 6       Auto Hold? n
Conference Parties without Public Network Trunks: 6     Attendant Tone? y
Night Service Disconnect Timer (seconds): 180         Bridging Tone? n
Short Interdigit Timer (seconds): 3                   Conference Tone? n
Unanswered DID Call Timer (seconds): _____     Intrusion Tone? n
Line Intercept Tone Timer (seconds): 30
DID Busy Treatment: tone
Allow AAR/ARS Access from DID/DIOD? _
    
```

DISTINCTIVE AUDIBLE ALERTING

```

Internal: 1 External: 2 Priority: 3
Attendant originated Calls: _ _____
DTMF Tone Feedback Signal to VRU - Connection: _ Disconnection: _
    
```

Screen 5-51. Feature-Related System Parameters form (page 5 of 8)

- **Public Network Trunks on Conference Call** — Enter **0** to **5** (default) to indicate the number of public network trunks allowed on a conference call. If this field is **0**, the `Conference Parties with Public Network Trunks` field will not appear on the form.
- **Conference Parties with Public Network Trunks** — Enter a number between **3** and **6** (default) to specify the maximum number of parties allowed in a conference call involving a public network subscriber. If the value of the `Public Network Trunks on Conference Call` field is **0**, this field will not appear on the form.
- **Conference Parties without Public Network Trunks** — Enter a number between **3** and **6** (default) to specify the maximum number of parties allowed in a conference call involving no public network trunks.
- **Night Service Disconnect Timer (seconds)** — Enter a number between **10** and **1024** or blank to indicate how long a trunk call can be unanswered during night service before being disconnected. The trunk must not have `Disconnect Supervision` for this timer to apply. Default is **180**.
- **Short Interdigit Timer (seconds)** — Enter a number between **3** (default) and **9** to limit the time that digit analysis will wait for the next digit when it has predicted that all the digits have already been collected.
- **Unanswered DID Call Timer (seconds)** — Enter number between **10** and **1024** or blank (default) to limit how long a DID call can remain unanswered before routing to the `DID/TIE/ISDN Intercept Treatment` feature. A value of blank disables this timer. This timer interacts with the nonadministrable 50 second `Wait for Answer Supervision Timer (WAST)`. The `WAST` timer overrides this field. Thus if this field is set to a value equal to or greater than 50 seconds, the caller receives intercept tone instead of the normal attendant or announcement treatment that is given when the `Unanswered DID Call Timer` expires before the `WAST`. If the `Unanswered DID Call Timer` expires while the DID call is being processed by call vectoring, the timer is ignored. See “`Wait Answer Supervision Timer`” in this section.
- **Line Intercept Tone Timer (seconds)** — Enter a number between **2** and **60** to specify how long an analog station user can wait after hearing warning tone without going on hook, before the station is placed in the lockout state. Default is **30**.
- **Auto Start** — Enter **y** to enable the Automatic Start feature. If this field is enabled, the `Start` buttons on all attendant consoles are disabled. Default is **n**.
- **Auto Hold** — Enter **y** to enable the Automatic Hold feature on a systemwide basis. Default is **n**.
- **Attendant Tone** — Enter **y** (default) to provide call progress tones to the attendants.
- **Bridging Tone** — Enter **y** to apply a bridging tone when calls are bridged on primary extensions. Default is **n**.

- **Conference Tone** — Enter **y** to provide conference tone as long as three or more calls are in a conference call. Default is **n**.

 **NOTE:**

Bridging and Conference Tones are not supported by all countries. If these tones are enabled for countries other than Italy, Belgium, United Kingdom, or Australia, the tones will be equivalent to no tone (silence) unless the tone is independently administered or customized on the System-Parameters Country Options form.

- **Intrusion Tone** — Enter **y** to apply an intrusion tone (executive override) when an attendant intrudes on the call. Default is **n**.
- **DID Busy Treatment** — Enter **attendant** or **tone** (default) to specify how to handle a DID call to a busy station.
- **Allow AAR/ARS Access from DID/DIOD** — Enter **y** to allow calls for DID and DIOD type trunk groups to complete calls using ARS or AAR. Default is **n**.

The next four fields control the Distinctive Audible Alerting feature. This feature provides an administrable ringing pattern (1-, 2-, or 3-bursts) for internal, external, and priority calls. An internal call is a station to station call, or a call over a tie trunk administered as "internal." An external call is from a trunk other than a tie trunk administered as "internal." A priority call is one so designated by the calling party. Only sets with correct permissions can make priority calls.

- **Internal** — Enter a number (1 through 3) to specify the ringing pattern for internal calls. Default is 1.
- **External** — Enter a number (1 through 3) to specify the ringing pattern for external calls. Default is 2.
- **Priority** — Enter a number (1 through 3) to specify the ringing pattern for priority calls. Default is 3.
- **Attendant Originating Calls** — Enter **internal**, **external** (default), or **priority** to indicate which type of ringing (defined above) to apply to attendant originated calls.
- **DTMF Tone Feedback Signal to VRU - Connection** — Enter the type of DTMF tone feedback signals to be provided to the VRU. Valid entries are the numbers 0 through 9, the characters \*, #, A, B, C, D, or blank. Blank means that no tone is to be sent to the VRU. This field appears only if DTMF Feedback Signals for VRU on the Customer-Options System Parameters form is **y**.
- **DTMF Tone Feedback Signal to VRU - Disconnection** — Enter the type of DTMF tone feedback signals to be provided to the VRU. Valid entries are the numbers 0 through 9, the characters \*, #, A, B, C, D, or blank. Blank means that no tone is to be sent to the VRU. This field appears only if DTMF Feedback Signals for VRU on the Customer-Options System Parameters form is **y**.

Page 6 of the form

Page 6 of 8

FEATURE-RELATED SYSTEM PARAMETERS

|                                  |  |
|----------------------------------|--|
| Pull Transfer: n                 | Update Transferred Ring Pattern? n         |
| Outpulse Without Tone? y         | Wait Answer Supervision Timer? n           |
| Misoperation Alerting? n         | Repetitive Call Waiting Tone? n            |
| Allow Conference via Flash? y    | Repetitive Call Waiting Interval (sec): _  |
| Vector Disconnect Timer (min): _ | Network Feedback During Tone Detection? y  |
| Hear Zip Tone Following VOA ? y  | System Updates Time On Station Displays? n |

|  |  |
|--|--|
| Intercept Treatment On Failed Trunk Transfers? n | Station Tone Forward Disconnect: silence |
|  | Level Of Tone Detection: precise         |
| Charge Display Update Frequency (seconds): 30    |  |
| Date Format on 6400/8400 Terminals: mm/dd/yy     |  |
| On-hook Dialing on 6400/8400 Terminals? n        |  |

RECALL TIMING

|                       |                                      |
|-----------------------|--------------------------------------|
| Flashhook Interval? y | Upper Bound (msec): 1000             |
|                       | Lower Bound (msec): 200              |
|                       | Forward Disconnect Timer (msec): 600 |

ENHANCED DCS

|                            |                                    |
|----------------------------|------------------------------------|
| Enhanced DCS Enabled? n    | Enforce PNT-to-PNT Restrictions? _ |
| Apply Intercept Locally? _ |                                    |

Screen 5-52. Feature-Related System Parameters form (page 6 of 8)

- **Pull Transfer** — Enter **y** to enable the Pull Transfer feature on a systemwide basis. Default is **n**.
- **Update Transferred Ring Pattern** — Enter **y** to change the ringing pattern from internal to external when an internal station transfers an external call.
- **Outpulse Without Tone** — Enter **y** (default) to indicate the switch will outpulse digits even when a dial tone has not been received. Enter “**n**” if the calling party should receive intercept tone if no dial tone is detected.
- **Wait Answer Supervision Timer** — Enter **y** to enable this feature on a systemwide basis. When **y** is entered in this field, calls to stations unanswered after 50 seconds are dropped. When **n** (default) is entered in this field, unanswered calls drop only when the calling party goes on-hook. See “Unanswered DID Call Timer” on [5-135](#).
- **Misoperation Alerting** — Enter **n** for standard misoperation handling without recall alerting. Enter **y** for misoperation recall alerting on multi-appearance stations, analog stations, and attendant consoles. Misoperation Alerting should not be enabled if Call Prompting is optioned.
- **Repetitive Call Waiting Tone** — Enter **y** to indicate a repetitive call waiting tone is provided to the called party for all forms of call waiting access. Default is **n**.

5 Basic Forms

Feature-Related System Parameters

Page 5-138

- **Allow Conference via Flash** — Enter **y** (default) to allow an analog station to use flash to conference calls together. Enter **n** to prevent this.
- **Repetitive Call Waiting Interval (sec)** (This field appears when the Repetitive Call Waiting Tone is **y**.) — Enter a number from **1** to **99** in increments of 1 to specify the number of seconds between call waiting tones.
- **Vector Disconnect Timer (min)** — Enter the number of minutes, between **1** and **240**, that a trunk should remain connected to a vector. The number of minutes that you enter determines when the trunk will be disconnected if the `Disconnect Supervision-In` or `Disconnect Supervision-Out` fields on the Trunk form are **n**. Enter blank if you do not want DEFINITY ECS to initiate a disconnect.
- **Network Feedback During Tone Detection** — Enter **y** (default) to provide audible feedback to the user while the system attempts to detect dial tone.
- **Hear Zip Tone Following VOA?** — Enter **y** to play zip tone following a VDN of Origin Announcement (VOA). This tone alerts a voice terminal user that the announcement has completed and a caller is now connected. CallMaster voice terminal and attendant console users hear double zip tone following the announcement. All other voice terminal users hear single zip tone. Enter **n** if you do not want zip tone following a VOA. Note this field does not effect auto-answer zip tone heard prior to the VOA.
- **System Updates Time On Station Displays** — Enter **y** to have the system automatically update the time on display terminals when background maintenance is run (for example, when the set is plugged in). This does not apply to terminals (such as BRI voice terminals) where the user sets the time.
- **Intercept Treatment on Failed Trunk Transfers** — Enter **y** to provide intercept treatment to calls failing trunk transfers. This provides misoperation handling for such calls. Enter **n** (default) to drop these calls.
- **Station Tone Forward Disconnect** — Enter **busy**, **intercept** or **silence** (default). When a station is the last party remaining off-hook on a call, that station receives the indicated tone or silence until that station is placed on-hook, or until the tone has played for 45 seconds and is followed by silence. The Tone Forward Disconnect applies to any station other than one administered as a data endpoint, an attendant console, a BRI terminal, an auto answer, or as an Outgoing Call Management (OCM) agent.
- **Level of Tone Detection** — Enter **broadband**, **medium**, or **precise** (default) to specify the precision level of tone detection to be supported in the switch.

- **Charge Display Update Frequency (seconds)** — The amount of time (in seconds) between charge-display updates. Valid values are **10–60**; default is **30**. This applies only if you use Advice of Charge or Periodic Pulse Metering with display functions. Frequent display updates may have considerable performance impact.
- **Date Format on 6400/8400 Terminals** — The format of the date as displayed on the terminals. Default is mm/dd/yy; the other options are dd/mm/yy and yy/mm/dd.
- **On-hook Dialing on 6400/8400 Terminals** — For 6400/8400 terminals users with speakerphones, allows you to use keypad dialing without first going off-hook. Enter **y** to perform Abbreviated Dialing while “on-hook.” Default is **n**.

The next four fields control station-to-switch recall signal timing. If a flashhook interval (recall window) is required, the upper and lower bounds of the interval can be administered. An on-hook that lasts for a period of time greater than or equal to the lower bound and less than or equal to the upper bound will be treated as a recall flash. If an interval is not required, the Disconnect Timing value must be administered. An on-hook that lasts for a period of time less than this value will be ignored; greater than or equal to this value will be regarded as a disconnect. Regardless, an on-hook lasting 50 to 150 ms coming from a 2500-type set will always be treated as a digit pulse unless Ignore Rotary Digits is **y** for that station.

- **Flashhook Interval** — Enter **y** to indicate that a flashhook interval (recall window) is required. If a **y** (default) is entered, `Upper Bound` and `Lower Bound` appear; if **n** is entered, `Disconnect Timing` appears.
- **Upper Bound (msec)** — Appears when `Flashhook Interval` is **y**. Specifies the upper bound of the station-to-switch recall signal timing interval in milliseconds. Enter **150** through **1250** (in increments of 10) to specify the upper bound of the flashhook interval. Default is **1000**.
- **Lower Bound (msec)** — Appears when `Flashhook Interval` is **y**. Specifies the lower bound of the station-to-switch recall signal timing interval in milliseconds. Enter **150** through **1250** (in increments of 10) to specify the lower bound of the flashhook interval. Default is **200**.
- **Forward Disconnect Timer (msec)** — Specify the duration of a momentary disconnect sent by the PBX to an analog station user when that user is the last party still off-hook on a call.

The next three fields control the Enhanced DCS feature.

- **Enhanced DCS Enabled?** — Enter **y** to enable the Enhanced DCS feature on a systemwide basis. Default is **n**.
- **Apply Intercept Locally?** — Enter **y** (default) to indicate that DID/CO intercept treatment will be applied locally instead of on the originating switch. This field appears only if `Enhanced DCS Enabled` is **y**.
- **Enforce PNT-to-PNT Restrictions?** — Enter **y** to indicate that restrictions and denial of PNT-to-PNT connections will be enforced when the EDCS message is unavailable. A **y** in this field means restrictions will be enforced. This field appears only if `Enhanced DCS Enabled` is **y**. Default is **n**.

## Implementation notes

---

A flash of 50 msec to 130 msec is always acceptable from a 2500-type set regardless of the setting of the Upper and Lower bounds and will be treated as the digit one.

## Page 6 of the form

```

                                                                 Page 6 of 8
                FEATURE-RELATED SYSTEM PARAMETERS

ISDN PARAMETERS

  Send Non-ISDN Trunk Goup Name as Connected Name? _
  Display Connected Name/Number for ISDN DCS Calls? _
  Send ISDN Trunk Group Name on Tandem Calls? n

                QSIG TSC Extension: ____
  Path Replacement with Measurements? n
```

## Screen 5-53. Feature-Related System Parameters form (page 6 of 8)



### NOTE:

This version of page 6 displays *only* if G3 Version is **v5** or greater on the System Parameters Customer Options form.



5 Basic Forms

Feature-Related System Parameters

- **Send Non-ISDN Trunk Group Name as Connected Name** — Enter **y** to send a name of the non-ISDN trunk group as the connected name when a call routes from ISDN to non-ISDN and the call is answered. Default is **n**.
- **Display Connected Name/Number for ISDN DCS Calls** — Enter **y** to display the connected name/number (if received) for ISDN DCS calls. Default is **n**.
- **Send ISDN Trunk Group Name on Tandem Calls** — Enter **y** to provide consistent display information regardless of trunk type. If set to **y**, provides only trunk group name. Default is **n**.
- **QSIG TSC Extension** — Displays only if G3 Version is **v6** or greater on the System Parameters Customer Options form. This is the phantom endpoint extension for QSIG Temporary Signaling Connections (TSCs) (both incoming and outgoing). Enter any valid, unassigned extension. Default is blank.
- **Path Replacement with Measurements** — Displays only if G3 Version is **v6** or greater on the System Parameters Customer Options form. Allows QSIG path replacement or DCS with Reroute to be attempted on measured calls. Default is **y**.

Page 7 of the form

Page 7 of 8

CALL CENTER SYSTEM PARAMETERS

EAS

Expert Agent Selection (EAS) Enabled? n

Minimum Agent-LoginID Password Length:

Direct Agent Announcement Extension: \_\_\_\_\_ Delay: \_\_\_\_

Message Waiting Lamp Indicates Status For: station

VECTORIZING

Converse First Data Delay: 0                      Second Data Delay: 2

Converse Signaling Tone (msec): 100                      Pause (msec): 70\_

Prompting Timeout (secs): 10

Interflow-qpos EWT Threshold: 2

SERVICE OBSERVING

Service Observing Warning Tone? n

ASAI

Call Classification After Answer Supervision? n                      Send UCID to ASAI? n

Screen 5-54. Feature-Related System Parameters form (page 7 of 8)

## Call Center System Parameters:

- **Expert Agent Selection (EAS) Enabled** — Only displays if `Expert Agent Selection (EAS)` on the System-Parameters Customer-Options form is **y**. Enter **y** to enable Expert Agent Selection. To enable this field, either no ACD or vectoring hunt groups may exist or, existing ACD or vectoring hunt groups must be "skilled." Default is **n**.
- **Minimum Agent-LoginID Password Length** — Only displays if `Expert Agent Selection (EAS)` on the System-Parameters Customer-Options form is **y**. Enter the minimum number of digits that must be administered as an EAS Agent's LoginID password. Valid entries are **0** through **9** or blank. Entering a **0** or blank indicates no password is required. Default is blank.
- **Direct Agent Announcement Extension** — Only displays if `Expert Agent Selection (EAS)` or `ASAI` on the System-Parameters Customer-Options form is **y**. Enter a valid announcement extension (consistent with the dial plan).
- **Direct Agent Announcement Delay** — Only displays if `Expert Agent Selection (EAS)` or `ASAI` on the System-Parameters Customer-Options form is **y**. Enter the number of seconds (**0** to **99**) the caller will hear ringback before the Direct Agent Announcement is heard by the calling party.
- **Message Waiting Lamp Indicates Status For** — Only displays if `Expert Agent Selection (EAS)` on the System-Parameters Customer-Options form is **y**. If `Expert Agent Selection (EAS) Enabled` is **y**, you can enter either **station** or **loginID**, otherwise you can only enter **station**.
- **Converse First Data Delay/Second Data Delay** — Only displays if `Vectoring (Basic)` on the System-Parameters Customer-Options form is **y**. The `First Data Delay` prevents data from being outpulsed (as a result of a converse vector step) from the system to CONVERSANT before CONVERSANT is ready. The delay commences when the CONVERSANT port answers the call. Enter the number of seconds (**0** to **9**) for the delay. Default is **0**. The `Second Data Delay` is used when two groups of digits are being outpulsed (as a result of a converse vector step) from the system to CONVERSANT. The `Second Data Delay` prevents the second set from being outpulsed before CONVERSANT is ready. The delay commences when the first group of digits has been outpulsed. Enter the number of seconds (**0** to **9**) for the delay. Default is **2**.
- **Converse Signaling Tone/Pause** — Only displays if `Vectoring (Basic)` and `DTMF` on the System-Parameters Customer-Options form are **y**. In the `Signaling Tone` field, enter the length in milliseconds of the digit tone for digits being passed to the CONVERSANT. In the `Pause` field, enter the length in milliseconds of the delay between digits being passed. The optimum timers for the CONVERSANT are a 100 msec tone and 70 msec pause.

Values entered in the `Tone/Pause` fields are rounded up or down depending upon the type of circuit pack used to output the digits.

- **TN742B or later suffix analog board** — Tone and pause round up or down to the nearest 25 msec. For example a 130 msec tone rounds down to 125 msec, a 70 msec pause rounds up to 75 msec for a total of 200 msec per tone.
- **TN464F, TN767E or later suffix DS1 boards** — Tone and pause round up to the nearest 20 msec. For example a 130 msec tone rounds up to 140 msec, a 70 msec pause rounds up to 80 msec for a total of 220 msec per tone.

If a circuit pack has been used for end-to-end signalling to the `CONVERSANT`, and has then been used to send digits to a different destination, the `CONVERSANT` timers may stay in effect. To reset your timers to the system default, pull and reseal the circuit pack.

- **Prompting Timeout (secs)** — Only displays if `Vectoring (Prompting)` on the System-Parameters Customer-Options form is **y**. Enter the number of seconds, from **4** to **10** (default), before the Collect Digits command times out for callers using rotary dialing.
- **Interflow-qpos EWT Threshold** — Part of enhanced Look-Ahead Interflow. Any calls predicted to be answered before this threshold will not be interflowed (therefore saving CPU resources). Enter the number of seconds for this threshold. The default is 2 seconds.
- **Service Observing Warning Tone** — `Service Observing (Basic)` on the System-Parameters Customer-Options form must be **y** before this field may be administered. Enter **y** to assign a warning tone to be given to voice terminal users and calling parties whenever their calls are being monitored using the Service Observing feature. Default is **n**.

 **NOTE:**

The use of Service Observing features may be subject to federal, state, or local laws, rules or regulations or require the consent of one or both of the parties to the conversation. Customers should familiarize themselves and comply with all applicable laws, rules, and regulations before using these features.

- **Call Classification After Answer Supervision?** — For use with ASAI Outbound Call Management (OCM). Enter **y** to force the switch to rely on the network to provide answer/busy/drop classification to the switch. After the call has been answered, a call classifier can be added to perform answering machine, modem and voice answering detection. Enter **n** for standard operation.
- **Send UCID to ASAI** — Valid entries are **n** or **y**. Enter **y** to enable transmission of Universal Call ID (UCID) information to ASAI. Enter **n** (default) to prevent transmission of UCID information to ASAI.

## Page 8 of the form

Page 8 of 8

CALL CENTER SYSTEM PARAMETERS

AGENT AND CALL SELECTION

- MIA Across Splits or Skills? n
- ACW Agents Considered Idle? y
- Call Selection Measurement: current-wait-time

REASON CODES

- Aux Work Reason Code Type: none
- Logout Reason Code Type: none

CALL MANAGEMENT SYSTEM

- Adjunct CMS Release:
- ACD Login Identification Length: 0
- BCMS/VuStats Measurement Interval: hour
- BCMS/VuStats Abandon Call Timer (seconds):
- Validate BCMS/VuStats Login IDs? n
- Clear VuStats Shift Data: on-login

### Screen 5-55. Feature-Related System Parameters form (page 8 of 8)

#### Agent and Call Selection Parameters:

- **MIA Across Splits or Skills?** — Enter **y** to remove an agent from the MIA queue for all the splits/skills/hunt groups that he or she is available in when the agent answers a call from any of his or her splits/skills/hunt groups. The default is **n**.
- **ACW Agents Considered Idle?** — Enter **y** (default) to have agents who are in After Call Work included in the Most-Idle Agent queue. Enter **n** to exclude ACW agents from the queue.
- **Call Selection Measurement** — Valid entries are **current-wait-time** (default) and **predicted-wait-time**. This field determines how DEFINITY ECS selects a call for an agent when the agent becomes available and there are calls in queue. Current Wait Time selects the oldest call waiting for any of the agent's skills. Predicted Wait Time is a feature of CentreVu<sup>®</sup> Advocate. For more information on CentreVu<sup>®</sup> Advocate, please contact your Account Executive.

#### Reason Codes Parameters:

- **Aux Work Reason Code Type** — Enter **none** if you do not want an agent to enter a Reason Code when entering AUX work. Enter **requested** if you want an agent to enter a Reason Code when entering AUX mode but do not want to force the agent to do so. Enter **forced** to force an agent to enter a Reason Code when entering AUX mode. To enter **requested** or **forced**, the Reason Codes and EAS on the System-Parameters Customer-Option form must be **y**.

5 Basic Forms

Feature-Related System Parameters

Page 5-145

- **Logout Reason Code Type** — Enter **none** if you do not want an agent to enter a Reason Code when logging out. Enter **requested** if you want an agent to enter a Reason Code when logging out but do not want to force the agent to do so. Enter **forced** to force an agent to enter a Reason Code when logging out. Enter **forced** to force an agent to enter a Reason Code when entering AUX mode. To enter **requested** or **forced**, the `Reason Codes` and `EAS` on the System-Parameters Customer-Option form must be **y**.

Call Management System Parameters:

- **Adjunct CMS Release** — Specifies the release of the CMS adjunct used with the system. For CMS, this field cannot be blank. Default is blank.
- **ACD Login Identification Length** — Enter the number of digits (**0** through **9**) for an ACD Agent Login ID if `Expert Agent Selection (EAS)` on the System-Parameters Customer-Options form is **n**. Default is **0**. If `BCMS/VuStats Login IDs` is **y**, the ACD Login ID length must be greater than 0. This field identifies an ACD agent to CMS. The number you enter in this field must equal the number of characters in the agent's login ID. For CMS, this field cannot be 0.
- **BCMS/VuStats Measurement Interval** — You can enter **half-hour** or **hour** (default) for polling and reporting measurement data if the `BCMS (Basic)` and/or the `VuStats` on the System-Parameters Customer-Options form is **y**. If neither of these features is optioned, and if you enter a value in the `BCMS Measurement Interval` field, the system displays the following error message:

**<value> cannot be used; assign either BCMS or VuStats first**

If you receive this message, see your Lucent Technologies representative to turn on `BCMS (Basic)` and/or `VuStats` on the System-Parameters Customer-Options form.

There are a maximum of 25 time slots available for measurement intervals. If **hour** is specified, an entire day of traffic information will be available for history reports; otherwise, only half a day will be available. This does not affect daily summaries as they always reflect traffic information for the entire day. The interval may be changed at any time, but will not go into effect until the current interval completes.

- **BCMS/VuStats Abandon Call Timer (seconds)** — Enter **none** or **1–10** to specify the number of seconds for calls to be considered abandoned. Calls with talk time that is less than this number (and that are not held) are tracked by BCMS and displayed by VuStats as ABAND calls.
- **Validate BCMS/VuStats Login IDs** — Enter **n** to allow entry of any ACD login of the proper length. Enter **y** to allow entry only of login-IDs that have been entered on the BCMS Login-ID form.
- **Clear VuStats Shift Data** — Enter **on-login** to clear shift data for an agent when the agent logs in. Enter **at-midnight** to clear shift data for all agents at midnight.

## Fiber Link Administration

---

This form administers fiber links, each of which is identified by a fiber number.

 **NOTE:**

Fiber link administration only applies to R5r and later configurations.

Port networks (PNs) are connected via direct fiber link connections or through a center stage switch (CSS) to provide the interconnection of port networks required for voice/data information transfer. The CSS is composed of "switch nodes" that can be interconnected in one or two levels to provide Port Network Connectivity (PNC). The CSS provides circuit-switched connectivity for voice and data communications as well as packet-switched connectivity. Fiber link administration permits an administration of translation data associated with a switch connection (such as optical fiber, metallic cable, or DS1CONV circuit packs and DS1 facility links between two endpoints). The two fiber endpoints can be:

- An expansion interface (EI) circuit pack
- A switch node interface (SNI) circuit pack

 **NOTE:**

Only one administrative terminal can administer fiber links at a time; others can display fiber link information.

### Administration commands

---

Use the following commands to administer the Fiber Link Administration form.

| Action  | Object     | Qualifier <sup>1</sup>  |
|---------|------------|-------------------------|
| add     | fiber-link | link number or ['next'] |
| change  | fiber-link | link number             |
| display | fiber-link | link number             |
| list    | fiber-link | link number             |
| remove  | fiber-link | link number             |

- 
1. Brackets [ ] indicate the qualifier is optional. Single quotes ( ' ' ) indicate the text inside the quote must be entered exactly as shown or an abbreviated form of the word may be entered.

PNCs have three different reliability configurations (one for each system reliability configuration) as follows:

| System Configuration | PNC  |
|----------------------|--|
| Standard Reliability | Simplex Fibers   |
| High Reliability     | Simplex Fibers to Expansion Port Networks and Duplicated Fibers between Processor Port Networks (PPN) and Switch Nodes |
| Critical Reliability | Duplicated Fibers  |

### Simplex PNC

For Simplex PNC, PNC Duplication is disabled on the System-Parameters Customer-Options form and Operation of Duplication is disabled on the Duplication-Related System-Parameters form.

### Administration of PNC Duplication

The PNC Duplication feature is enabled on the System-Parameters Customer-Options form and Operation of Duplication is enabled on the Duplication-Related System-Parameters form. When PNC Duplication is enabled on the System-Parameters Customer-Options form, the following administration forms change:

- Cabinet form — Additional fields appear to allow administration of switch nodes to A-PNC and B-PNC sides of the CSS. The B-PNC is the duplicated hardware for the A-PNC. Either the A-PNC or the B-PNC can provide full customized service. B-PNC cannot be used in a simplex PNC configuration. Pairing of switch nodes is also defined here.
- Fiber Link form — Additional fields appear to allow administration of fiber links on the B-PNC side of the CSS. If an endpoint on the A-PNC side is administered as an SNI, its corresponding endpoint on the B-PNC side is determined (if switch nodes are paired in the cabinet form prior to this administration) and displayed. However, administration of the duplicate B-PNC link is not enforced until duplication is in full operation.
- Duplication-Related System-Parameters form — An additional field appears to enable operation of PNC duplication.

## Form instructions

---

### Page 1 of the form

Page 1 of 1

FIBER LINK ADMINISTRATION

Fiber Link #: 1

Is one endpoint remoted via a DS1 Converter Complex? \_\_\_\_

|                       |                       |
|-----------------------|-----------------------|
| ENDPOINT-1<br>(A-PNC) | ENDPOINT-2<br>(A-PNC) |
| Board Location: ____  | Board Location: ____  |
| Board Type: xxx       | Board Type: xxx       |

### Screen 5-56. Fiber Link Administration form

#### Basic Fiber Link Administration

The following fields appear:

- **Fiber Link #** — Display-only field. From the command line, enter a 1- to 3-digit number to uniquely identify a switch connection in the system and its duplicate if appropriate.
- **Board Location** — Enter the cabinet, carrier, and slot that identifies the physical location of an SNI or EI board that is the first endpoint of the fiber link.
- **Board Type** — Display-only field showing the type of circuit pack in Endpoint-1.
- **Board Location** — Enter the cabinet, carrier, and slot that identifies the physical location of an SNI or EI board that is the second endpoint of the fiber link.
- **Board Type** — Display-only field showing the type of circuit pack in Endpoint-2.
- **Is one endpoint remoted via a DS1 Converter Complex?** — Enter **y** to specify that a DS1 Converter complex is used to remote one endpoint. If a **y** is entered, A-PNC DS1 Converter circuit pack Location must be administered on Page 1. A-PNC DS1 Converter circuit pack Type displays. A-PNC DS1 Converter (DS1CONV) Attributes must be administered on Page 2 of this form.



## Duplicated Fiber Link Administration

```

add fiber-link next                                     Page 1 of 3
                                                    FIBER LINK ADMINISTRATION

Fiber Link #: 1
Is one endpoint remoted via DS1 Converter Complex? yes

      ENDPOINT-1                                     ENDPOINT-2
      (A-PNC)                                       (A-PNC)
Board Location: 01E01                               Board Location: 02A01
Board Type: ei                                       Board Type: ei
DS1CONV Board Location: 01B01                       DS1CONV Board Location: 02B01
DS1CONV Board Type: TN574                           DS1CONV Board Type: TN574

      ENDPOINT-1                                     ENDPOINT-2
      (B-PNC)                                       (B-PNC)
Board Location: 01D01                               Board Location: 02A02
Board Type: ei                                       Board Type: ei
DS1CONV Board Location: 01C01                       DS1CONV Board Location: 02C01
DS1CONV Board Type: TN574                           DS1CONV Board Type: TN574

```

Screen 5-57. Fiber Link Administration form (page 1 of 3)

The following fields appear when Administration of PNC Duplication is enabled on the System-Parameters Customer-Options form:

- **Fiber Link #** — Display-only field. From the command line, enter a 1- to 3-digit number to uniquely identify a switch connection in the system and its duplicate if appropriate.
- **Is one endpoint remoted via DS1 Converter Complex?** — Enter **yes** to specify that a DS1 converter complex is used to remote one endpoint. If **yes** is entered, A-PNC and B-PNC DS1 Converter (DS1CONV) Attributes must be administered on Pages 2 and 3 (respectively) of the form.
- **Board Location** — Enter the cabinet, carrier, and slot that identifies the physical location of a circuit pack in the first endpoint of the duplicate fiber link. Endpoint-1's duplicate along with Endpoint-2's duplicate make up the duplicate fiber link called the B-PNC link.
- **Board Type** — Display-only field showing the type of circuit pack in Endpoint-1. The circuit pack type in Endpoint-1 (A-PNC) and Endpoint-1 (B-PNC) must be the same.
- **DS1CONV Board Location** — Enter the cabinet, carrier, and slot that identifies the physical location of DS1 Converter circuit pack in the first endpoint of the duplicate fiber link. Endpoint-1's duplicate along with Endpoint-2's duplicate make up the duplicate fiber link called the B-PNC link.

- **DS1CONV Board Type** — Display-only field showing the type of DS1 Converter circuit pack in Endpoint-1. The circuit pack type in Endpoint-1 (A-PNC) and Endpoint-1 (B-PNC) must be the same. This field is updated via the Change Circuit-packs command.
- **Board Location** — Enter the cabinet, carrier, and slot that identifies the physical location of a circuit pack in the second endpoint of the duplicate fiber link. Endpoint-2's duplicate along with Endpoint-1's duplicate make up the duplicate fiber link called the B-PNC link.
- **Board Type** — Display-only field showing the type of circuit pack in Endpoint-2. The circuit pack type in Endpoint-2 (A-PNC) and Endpoint-2 (B-PNC) must be the same.
- **DS1CONV Board Location** — Enter the cabinet, carrier, and slot that identifies the physical location of DS1 Converter circuit pack in the second endpoint of the duplicate fiber link. Endpoint-2's duplicate along with Endpoint-1's duplicate make up the duplicate fiber link called the B-PNC link.
- **DS1CONV Board Type** — Display-only field showing the type of DS1 Converter circuit pack in Endpoint-2. The circuit pack type in Endpoint-2 (A-PNC) and Endpoint-2 (B-PNC) must be the same. This field is updated via the Change Circuit-packs command.

### DS1C Converter Complex Administration for TN574 Circuit Packs

add fiber-link next

Page 2 of 3

FIBER LINK ADMINISTRATION  
 A-PNC DS1 CONVERTER (DS1CONV) ATTRIBUTES

DS1CONV Board Location: 01B01                      DS1CONV Board Location: 02B01  
 DS1CONV Board Type: TN574                          DS1CONV Board Type: TN574

DS1 CONVERTER FACILITIES

|                              | A       | B       | C       | D       |
|------------------------------|---------|---------|---------|---------|
| Facility Installed?          | yes     | no      | no      | no      |
| Passes Far-end Clock?        | yes     | yes     | yes     | yes     |
| Digital Data Compatible?     | yes     | yes     | yes     | yes     |
| Line Coding:                 | ami-zcs | ami-zcs | ami-zcs | ami-zcs |
| Framing Mode:                | esf     | esf     | esf     | esf     |
| DS1CONV-1 Line Compensation: | 1       | 1       | 1       | 1       |
| DS1CONV-2 Line Compensation: | 1       | 1       | 1       | 1       |

Facility A Circuit ID: 09876543

The following DS1 Converter Complex fields appear on Page 2 when the Is one endpoint remoted via a DS1 Converter Complex field is **y**.

 **NOTE:**

When you administer DS1 Converter TN1654 circuit packs, different fields display.

- **DS1CONV Board Location** — Enter the cabinet, carrier, and slot that identifies the physical location of the converter circuit pack connected to the first endpoint of the fiber link. This is entered on Page 1 and displays on Page 2.
- **DS1CONV Board Type** — Display-only field showing the type of DS1 Converter circuit pack for the first endpoint.
- **DS1CONV Board Location** — Enter the cabinet, carrier, and slot that identifies the physical location of the converter circuit pack connected to the second endpoint of the fiber link.
- **DS1CONV Board Type** — Display-only field showing the type of DS1 Converter circuit pack for the second endpoint. This field is updated via the Change Circuit-packs command.
- **Facility Installed** — Enter **yes** in the B, C, and D columns under the DS1 Converter Facilities heading to indicate that this DS1 facility is physically installed. At least facility A must be installed within the converter complex. Default is **yes** for Facility A.
- **Passes Far-end Clock** — Enter **"yes"** in the B, C, and D columns under the DS1 Converter Facilities heading to indicate that this DS1 facility is suitable to be used as a clock source. If the DS1 signal does not come directly from the far end converter circuit pack or the network (such as when the signal is converted from digital to analog and then back to digital), enter **"no."** Default is **yes** for Facility A.

This field determines whether the DS1 converter circuit pack can use receive DS1 signal timing to time the transmit fiber signal. This is necessary for passing timing from a master PN to a slave PN across a Converter Complex.

- **Digital Data Compatible** — Enter **yes** (default) in the B, C, and D columns under the DS1 Converter Facilities heading to indicate that this DS1 facility is suitable for transmission of digital data. At least Facility A must be suitable for transmission of digital data. If Customer Premises Equipment that alters digital data exists on this facility (such as with a channel expansion multiplexer), enter **no**.
- **Line Coding** — Enter the line coding format, **ami-zcs** (default), or **ami-basic**, **b8zs**, or **hdb3** in the A, B, C, and D columns under the DS1 Converter Facilities heading for each DS1 facility.

When ami-zcs line coding is used, all-zero bytes are prevented from being transmitted on the DS1 facility because a 1 is arbitrarily written into the second position of each byte. Thus, if no measures are taken to prevent it,

ami-zcs line coding results in data corruption. The DS1CONV circuit pack protects the packet facility (one of up to four facilities dynamically allocated by the DS1CONV circuit pack) from corruption through a special escape mechanism.

When b8zs line coding is used, it maintains DS1 facility's ones-density requirements by encoding a zero data byte into a specific unique pattern of bipolar violations on the DS1 line. The opposite end recognizes this pattern and replaces it with a zero data byte when the data is recovered at the receiving end.

**⇒ NOTE:**

Note that although the esf framing mode and b8zs line coding are the preferable modes of operation, you should confirm that the DS1 facilities support them before selecting this line coding.

- **Framing Mode** — Enter the framing format, **esf** (default) or **d4**, in the A, B, C, and D columns under the DS1 Converter Facilities heading for each DS1 facility.

**⇒ NOTE:**

The D4 format is supported by the Converter circuit packs, but because of problems inherent with this format (specifically, inability to frame on a bit stream that contains data that emulates the D4 framing pattern), its use is discouraged.

- **DS1CONV-1 Line Compensation** — Enter the line compensation (**1 to 5**) in the A, B, C, and D columns under the DS1 Converter Facilities heading for each DS1 facility connected to ENDPOINT-1 (see [Table 5-3](#)).

The DS1 line signal is pre-equalized at the transmitter so that DS1 line pulses are the correct amplitude and shape when they reach the Network Interface. The amount of equalization necessary is determined by the distance to the Network Interface (when the endpoint supplies a DSX-1 interface) and also by the type of wiring used to connect to the Network Interface. The types of wiring allowed are 22 gauge ABAM (shielded twisted pair) cable, 24 gauge Premises Distribution System (PDS) wiring, and 26 gauge PDS wiring.

**Table 5-3. Distance to DSX-1 Interface (feet)**

| Equalizer Setting | 22 AWG ABAM & 24 AWG PDS | 26 AWG PDS |
|-------------------|--------------------------|------------|
| 1                 | 1 to 133                 | 0 to 90    |
| 2                 | 133 to 266               | 90 to 180  |

*Continued on next page*

Table 5-3. Distance to DSX-1 Interface (feet — *Continued*)

| Equalizer Setting | 22 AWG ABAM & 24 AWG PDS | 26 AWG PDS |
|-------------------|--------------------------|------------|
| 3                 | 266 to 399               | 180 to 270 |
| 4                 | 399 to 533               | 270 to 360 |
| 5                 | 533 to 655               | 360 to 450 |

 **NOTE:**

The line equalization setting defaults to 2 and remains in effect until changed by administration. Because incorrect equalizer settings cause a potentially higher error rate on the DS1 facility, it is necessary to provide the correct settings based on the distance to the Network interface.

If it is a TN574 circuit pack, the default for all facilities is 1.

- **DS1CONV-2 Line Compensation** — Enter the line compensation (1 to 5) in the A, B, C, and D columns under the DS1 Converter Facilities heading for each DS1 facility connected to ENDPOINT-2 (see [Table 5-3](#)). The DS1 line signal is pre-equalized at the transmitter so that DS1 line pulses are the correct amplitude and shape when they reach the Network Interface. The amount of equalization necessary is determined by the distance to the Network Interface (when the endpoint supplies a DSX-1 interface) and also by the type of wiring used to connect to the Network Interface. The types of wiring allowed are 22-gauge ABAM (shielded twisted pair) cable, 24-gauge Premises Distribution System (PDS) wiring, and 26-gauge PDS wiring.
- **Facility A Circuit ID** — Displays when the value in `Facility Installed` for Facility A is **yes**. Enter up to 40 characters to identify the cabinet, carrier, and slot of the DS1 Converter circuit pack's physical location.

Similarly, Facility B Circuit ID, Facility C Circuit ID, and Facility D Circuit ID fields display for each of the DS1 Converter Facilities when **yes** is entered in the corresponding Facility Installed field.

## Duplicated DS1C Converter Complex Administration for TN574 Circuit Packs

add fiber-link next

Page 3 of 3

FIBER LINK ADMINISTRATION  
B-PNC DS1 CONVERTER (DS1CONV) ATTRIBUTES

DS1CONV Board Location: 01C01                      DS1CONV Board Location: 02C01  
DS1CONV Board Type: TN574                        DS1CONV Board Type: TN574

DS1 CONVERTER FACILITIES

|                              | A       | B       | C       | D       |
|------------------------------|---------|---------|---------|---------|
| Facility Installed?          | yes     | no      | no      | no      |
| Passes Far-end Clock?        | yes     | yes     | yes     | yes     |
| Digital Data Compatible?     | yes     | yes     | yes     | yes     |
| Line Coding:                 | ami-zcs | ami-zcs | ami-zcs | ami-zcs |
| Framing Mode:                | esf     | esf     | esf     | esf     |
| DS1CONV-1 Line Compensation: | 1       | 1       | 1       | 1       |
| DS1CONV-2 Line Compensation: | 1       | 1       | 1       | 1       |

Facility B Circuit ID: 01112343

### Screen 5-59. Fiber Link Administration form for TN574 Circuit Pack (Duplicated DS1 Converter Complex Administration) (page 3 of 3)

Page 3 appears when the Is one endpoint remoted via a DS1 Converter Complex field is **"yes"** and duplication is enabled.

 **NOTE:**

When you administer DS1 Converter TN1654 circuit packs, different fields display.

For field definitions of the fields displayed on page 3 of the Fiber Link Administration form, refer back to the previous section.

## DS1 Converter Complex Administration for T1 TN1654 Circuit Packs

add fiber-link next

Page 2 of 3

FIBER LINK ADMINISTRATION  
 A-PNC DS1 CONVERTER (DS1CONV) ATTRIBUTES

DS1CONV Board Location: 01B01                      DS1CONV Board Location: 02B01  
 DS1CONV Board Type: TN1654                      DS1CONV Board Type: TN1654

DS1 CONVERTER FACILITIES

|                              | A         | B       | C       | D       |
|------------------------------|-----------|---------|---------|---------|
| Facility Installed?          | yes       | yes     | no      | no      |
| Bit Rate:                    | 1.544     |         |         |         |
| Facility Startup Idle Code:  | 11101000  |         |         |         |
| Line Coding:                 | ami-zcs   | ami-zcs | ami-zcs | ami-zcs |
| Framing Mode:                |           |         |         |         |
| DS1CONV-1 Line Compensation: | 1         | 1       | 1       | 1       |
| DS1CONV-2 Line Compensation: | 1         | 1       | 1       | 1       |
| Facility A Circuit ID:       | 09876543  |         |         |         |
| Facility B Circuit ID:       | 234567889 |         |         |         |

### Screen 5-60. Fiber Link Administration form for T1 TN1654 Circuit Pack (DS1 Converter Complex Administration) (page 2 of 3)

The following unique fields display when administering a T1 TN1654 DS1 Converter.

- **Bit Rate** — Displays when the DS1 Converter circuit pack is TN1654. Enter either **1.544** for domestic T1 operation or **2.048** for international E1 operation.



**NOTE:**

Since one bit rate applies for all facilities within the same DS1 Converter complex, the `Bit Rate` field displays only under Facility A.

- **Facility Startup Idle Code**— Displays when the DS1 Converter circuit pack is TN1654. Enter 8 digits, each digit must be **0** or **1**. The second digit must be **1**. Default is **11101000**. You can administer this field on a per circuit pack basis. This is the idle code used when a TN1654 first establishes a link on a T1/E1 facility. The initial idle code used by the TN1654 is overwritten by the center stage switch to an “all ones” pattern once framing is established on that T1/E1 facility.
- **Framing Mode** — For TN1654 with 1.544 Mbps Bit Rate, this is a display-only field.

## Duplicated DS1 Converter Complex Administration for T1 TN1654 Circuit Packs

add fiber-link next

Page 2 of 3

FIBER LINK ADMINISTRATION  
 A-PNC DS1 CONVERTER (DS1CONV) ATTRIBUTES

DS1CONV Board Location: 01B01                      DS1CONV Board Location: 02B01  
 DS1CONV Board Type: TN1654                      DS1CONV Board Type: TN1654

DS1 CONVERTER FACILITIES

|                             | A        | B    | C    | D    |
|-----------------------------|----------|------|------|------|
| Facility Installed?         | yes      | yes  | yes  | no   |
| Bit Rate:                   | 2.048    |      |      |      |
| Facility Startup Idle Code: | 11101000 |      |      |      |
| Line Coding:                | hdb3     | hdb3 | hdb3 | hdb3 |
| CRC?                        | yes      |      |      |      |
| Line Termination:           |          |      |      |      |

Facility A Circuit ID: 09876543  
 Facility B Circuit ID: 234567889  
 Facility C Circuit ID: 434566335

### Screen 5-61. Fiber Link Administration form for E1 TN1654 Circuit Pack (DS1 Converter Complex Administration) (page 2 of 3)

The following unique fields display when administering a TN1654 DS1 Converter.

- **Bit Rate** — A display-only field for TN1654 entered on page 3 of the form. See previous section. **1.544** indicates domestic T1 operation and **2.048** indicates international E1 operation.

### DS1 Converter Complex Administration for E1 TN1654 Circuit Packs

The following unique fields display when administering a E1 TN1654 DS1 Converter.

- **Bit Rate** — Displays when the DS1 Converter circuit pack is TN1654. Enter either **1.544** for domestic T1 operation or **2.048** for international E1 operation.



**NOTE:**

Since one bit rate applies for all facilities within the same DS1 Converter complex, *Bit Rate* displays only under Facility A. To activate the desired Bit Rate, the toggle switch on the circuit pack must be set and it must correspond to the Bit Rate.

- **Idle Code MSB(1) ... LSB(8)** — Displays when the DS1 Converter circuit pack is TN1654. Enter 8 digits, each digit must be **0** or **1**. The second digit must be **1**. Default is **11101000**. You can administer this field on a per circuit pack basis.



5 Basic Forms

Fiber Link Administration

- **CRC** — Displays when the DS1 Converter circuit pack is TN1654 and the Bit Rate is 2.048 Mbps. Enter **yes** to receive a “yellow 2” alarm for E1 operation. Default is **no**. You can administer this field on a per circuit pack basis.
- **Line Termination** — A display-only field for DS1 Converter circuit packs that are TN1654 and have a Bit Rate of 2.048 Mbps. It identifies facility connections as CEPT 75 ohm coaxial or 120 ohm CEPT twisted pair.

### Duplicated DS1 Converter Complex Administration for E1 TN1654 Circuit Packs

See the previous sections for screen layout and field definitions.

```
add fiber-link next Page 3 of 3  
  
                FIBER LINK ADMINISTRATION  
                B-PNC DS1 CONVERTER (DS1CONV) ATTRIBUTES  
  
DS1CONV Board Location: 01C01           DS1CONV Board Location: 02C01  
DS1CONV Board Type: TN1654             DS1CONV Board Type: TN1654  
  
                DS1 CONVERTER FACILITIES  
  
                A           B           C           D  
Facility Installed?  yes       yes       yes       no  
                Bit Rate:  2.048  
Facility Startup Idle Code: 11101000  
                Line Coding: hdb3       hdb3       hdb3       hdb3  
                CRC?       yes  
                Line Termination:  
  
Facility A Circuit ID: 0AABB01  
Facility B Circuit ID: 0CCDD02  
Facility C Circuit ID: 0EEFF03
```

Screen 5-62. Fiber Line Administration form for B-PNC DS1 Converter (DS1CONV) Attributes

## Hunt Group

---

Allows calls to be answered by users (agents) at a predefined group of terminals or devices.

This form creates a hunt group that is identified by a hunt group number. Users assigned to a hunt group are identified by their extension number.

### NOTE:

If `Hospitality Parameter Reduction` is enabled on the `System-Parameters Customer-Options` form, only five hunt groups can be assigned.

This form can be used to implement a hunt group and its associated features such as Automatic Call Distribution (ACD) and Hunt Group Queuing. Look at the various hunt group forms and choose the forms that can be used to implement your hunt group requirements.

The total number of pages vary depending on your System configuration. See the *DEFINITY Enterprise Communications Server Release 6 System Description Pocket Reference* for the maximum number of hunt groups supported by each configuration.

The System checks for the busy or idle status of extension numbers in the hunt group when answering calls. A Uniform Call Distribution (UCD) type hunt group selects the “most idle” extension in the group when answering a new call. A Direct Department Calling (DDC) type hunt group selects the first available extension (in the administered sequence) when answering a new call. Expert Agent Distribution (EAD), used only with Expert Agent Selection (EAS), selects the “most idle” agent or the “least occupied”<sup>1</sup> agent with the highest skill level for the call’s skill.

### NOTE:

Vector controlled splits/skills can be called directly via the split/skill extension (instead of calling a VDN mapped to a vector that will terminate the call to a vector controlled split/skill); however, the calls will not receive any announcements, be forwarded, redirect to coverage, or intraflow/interflow to another hunt group.

---

1. CentreVu<sup>®</sup> Advocate software is required to select agents on the basis of occupancy. For more information about CentreVu<sup>®</sup> Advocate, contact your Account Executive.

## Administration commands

---

Use the following commands to administer the Hunt Group form.

|   | Action  | Object     | Qualifier <sup>1</sup>        |
|---|---------|------------|-------------------------------|
| Without Hospitality<br>Parameter Reduction<br>Feature | add     | hunt-group | 1-MAX (or 'next')             |
|   | change  | hunt-group | 1-MAX                         |
|   | display | hunt-group | 1-MAX ['print' or 'schedule'] |
|   | list    | hunt-group | ['print' or 'schedule']       |
|   | remove  | hunt-group | 1-MAX                         |
| With Hospitality<br>Parameter Reduction<br>Feature    | add     | hunt-group | 1-5 (or 'next')               |
|   | change  | hunt-group | 1-5                           |
|   | display | hunt-group | 1-5 ['print' or 'schedule']   |
|   | list    | hunt-group | ['print' or 'schedule']       |
|   | remove  | hunt-group | 1-5                           |

- 
1. Brackets [ ] indicate the qualifier is optional. Single quotes ( ' ) indicate the text inside the quote must be entered exactly as shown or an abbreviated form of the word can be entered. MAX is the maximum number available in your system configuration.

## Form instructions

---

Make assignments as required for the following fields on each page of the form. [Screen 5-63](#) shows page 1 of the Hunt Group form with all fields displayed.

The two `Extension` fields display only when `Calls Warning Port` and `Time Warning Port` fields are **X**.

### Page 1 of the form

```

                                     HUNT GROUP
                                     Page 1 of X

Group Number:  ___                      ACD?  _
Group Name:    _____                Queue? _
Group Extension:  ___                    Vector? _
Group Type:    _____                Coverage Path:  ___
                TN:  ___                  Night Service Destination:  ___
                COR:  _                    MM Early Answer?  _
Security Code:  ___
ISDN Caller Disp:  _____

Queue Length:  ___
Calls Warning Threshold:  ___  Port:  x___  Extension:  ___
Time Warning Threshold:  ___  Port:  x___  Extension:  ___
```

### Screen 5-63. Hunt Group form (page 1 of X)

#### Implementation notes

---

Page 1 when the Queue and Vector fields are n.

```

                                     HUNT GROUP
                                     Page 1 of X

Group Number:  ___                      ACD?  n
Group Name:    _____                Queue? n
Group Extension:  ___                    Vector? n
Group Type:    _____                Coverage Path:  ___
                TN:  ___                  Night Service Destination:  ___
                COR:  _                    MM Early Answer?  _
Security Code:  ___
ISDN Caller Disp:  _____
```

### Screen 5-64. Hunt Group form (page 1 of X)

#### Implementation notes

---

Page 1 when the Queue and Vector fields are y.

The two Extension fields display only when Calls Warning Port and Time Warning Port fields are X.

Page 1 of X

HUNT GROUP

Group Number: \_\_\_\_\_ ACD? n  
 Group Name: \_\_\_\_\_ Queue? y  
 Group Extension: \_\_\_\_\_ Vector? y  
 Group Type: \_\_\_\_\_  
 TN: \_\_\_\_\_  
 COR: \_\_\_\_\_ MM Early Answer?  
 Security Code: \_\_\_\_\_  
 ISDN Caller Disp: \_\_\_\_\_

Queue Length: \_\_\_\_\_  
 Calls Warning Threshold: \_\_\_\_\_ Port: x\_\_\_\_\_ Extension: \_\_\_\_\_  
 Time Warning Threshold: \_\_\_\_\_ Port: x\_\_\_\_\_ Extension: \_\_\_\_\_

Screen 5-65. Hunt Group form (page 1 of X)

**Implementation notes**

Page 1 when the Vector field is **n** and the Queue field is **y**.

The two Extension fields display only when Calls Warning Port and Time Warning Port fields are **X**.

Page 1 of X

HUNT GROUP

Group Number: \_\_\_\_\_ ACD? n  
 Group Name: \_\_\_\_\_ Queue? y  
 Group Extension: \_\_\_\_\_ Vector? n  
 Group Type: \_\_\_\_\_ Coverage Path: \_\_\_\_\_  
 TN: \_\_\_\_\_ Night Service Destination: \_\_\_\_\_  
 COR: \_\_\_\_\_ MM Early Answer?  
 Security Code: \_\_\_\_\_  
 ISDN Caller Disp: \_\_\_\_\_

Queue Length: \_\_\_\_\_  
 Calls Warning Threshold: \_\_\_\_\_ Port: x\_\_\_\_\_ Extension: \_\_\_\_\_  
 Time Warning Threshold: \_\_\_\_\_ Port: x\_\_\_\_\_ Extension: \_\_\_\_\_

Screen 5-66. Hunt Group form (page 1 of X)

- **Group Number** — Enter a hunt group number when completing a paper form (only five hunt groups can be assigned if the Hospitality Parameters Reduction is enabled on the System-Parameters Customer-Options form). This is a display-only field when the form is accessed using an administration command such as **add** or **change**.

- **Group Name** — Enter a 28-character string that uniquely identifies the group (for example, "parts dept," "purchasing," or "sales dept").
- **Group Extension** — Enter an unused extension number (1 to 5 digits) to be assigned to the hunt group.
- **Group Type** — There are five group types: Uniform Call Distribution (ucd-mia and ucd-loa), Direct Department Calling (DDC), and Expert Agent Distribution (ead-mia and ead-loa). Each option uses a different method to select an agent for a call when two or more agents are available.

Enter **ddc** when the call should be routed to the first available agent in the administered string. Group type **ddc** is also known as "hot seat". "ddc" distribution is not available when the group is administered as a skill.

When **ucd-mia** or **ucd-loa** is entered, a call routes to the most-idle agent ("ucd-mia") or the least occupied agent ("ucd-loa"), respectively.<sup>2</sup> Enter **ucd-mia** (default) or **ucd-loa** if the hunt group has an AUDIX or Messaging Server Adjunct message. One of these entries is required when supporting the Outbound Call Management feature and when the "Controlling Adjunct" field is administered as **asai**.

When **ead-mia** or **ead-loa** is entered, a call routes to the available agent with the highest skill level for the call. If two or more agents with equal skill levels are available, DEFINITY ECS routes the call to the most-idle agent ("ead-mia") or the least occupied agent ("ead-loa"), respectively. This allows a call to be distributed to the agent best able to handle the call if multiple agents are available.

**ucd-loa** and **ead-loa** cannot be entered in the Group Type field unless `CentreVu Advocate` is set to **y** on the System Parameters Customer-Options form. **ead-mia** and **ead-loa** cannot be entered in the Group Type field unless `Expert Agent Selection (EAS)` is set to **y**.

- **TN** — Enter the Tenant Partition number. Default is **1**.
- **COR** — Enter the class of restriction (COR) number from **0** through **95** that reflects the desired restriction for the hunt group. If this is a hunt group supporting the AUDIX in a DCS feature, the CORs on the Hunt Group form on each switch must be the same. Default is **1**.
- **Security Code** — Enter a 4-digit security code (password) used for the Demand Print feature. Valid entries are a 4-digit security code or leave blank.
- **ISDN Caller Disp** — Enter **grp-name** or **mbr-name** to specify whether the hunt group name or member name, respectively, will be sent to the originating user. This field is required if the `ISDN-PRI` or `ISDN-BRI Trunks` on the System-Parameters Customer-Options form is enabled. If `ISDN-PRI` or `ISDN-BRI Trunks` is not enabled, this field must be blank.

---

2. Least occupied agent (LOA), is a new agent selection method available on DEFINITY ECS R3V6 and later switches when you purchase CentreVu<sup>®</sup> Advocate software. For more information about CentreVu<sup>®</sup> Advocate, contact your Lucent Account Executive.

- **ACD** — Enter **y** if the hunt group will function as an ACD split/skill. AUDIX and MSA hunt groups can function as ACD splits/skills. This field cannot be set to **y** if the **ACD** option is not enabled on the System-Parameters Customer-Options form. Enter **n** (default) if this feature is not desired, even if **ACD** is enabled on the System-Parameters Customer-Options form. When the hunt group is assigned as an ACD split/skill, the hunt group members serve as ACD agents. The agents in this split/skill must log in to receive ACD split/skill calls. If this hunt group is on a remote switch using the AUDIX in a DCS feature, enter **n**.
- **Queue** — Enter **y** if the hunt group will be served by a queue. Default is **n**.
- **Vector** — Enter **y** to indicate that this hunt group will be vector controlled. **Vectoring-Basic** must be enabled on the System-Parameters Customer-Option form before **y** can be entered in the field. Default is **n**. (See example screen forms for fields that are displayed when this field is set to **y**.)
- **Coverage Path** — Not displayed if **Vector** is **y**. Enter a coverage path number. This assigns a coverage path for the hunt group. The coverage path is assigned using the Coverage Path form. Valid entries vary depending on the system configuration, or leave blank.
- **Night Service Destination** — Not displayed if **Vector** is **y**. Enter the destination where calls to this split will redirect when the split is in the night service mode. Valid entries are an assigned extension number (can be a VDN extension), the attendant group code, or leave blank.
- **MM Early Answer** — This field applies for systems using Multimedia Call Handling only. If **y**, the system begins to answer an H.320 call and establish an audio channel before offering the conversion call to the hunt group.

The following fields display if **Queue** is **y**:

- **Queue Length** — Enter the maximum number of calls that can be in the queue at the same time. This field must have an entry when **Queue** is **y**.
- **Calls Warning Threshold** — Enter the number of calls that can be queued before the System flashes the queue status (feature buttons assigned on agents voice terminals) and the optional Auxiliary Queue Call Warning Threshold lamp assigned to the split/skill. These lamps are lighted steadily when at least one call is in queue and the threshold has not yet been reached. Must be less than or equal to the queue length or leave blank. This field must not be left blank if **Calls Warning Port** is assigned a port number.
- **(Calls Warning) Port** — Enter the seven-character port number assigned to connect the optional external Auxiliary Queue Call Warning Threshold lamp that will flash when the number of calls in queue has exceeded the queue warning threshold (assigned in **Calls Warning Threshold**).

The entry breaks down as follows:

| Characters | Meaning        | Value         |
|------------|----------------|---------------|
| 1-2        | Cabinet Number | 01 through 44 |
|            |                | 01 through 03 |
|            |                | 01            |
| 3          | Carrier        | A through E   |
| 4-5        | Slot Number    | 01 through 20 |
| 6-7        | Circuit Number | 01 through 16 |

 **NOTE:**

This port is assigned to an Analog Line circuit pack or given an "X" designation if an extension is used.

- **(Calls Warning) Extension** — An extension is needed when an X is placed in `Calls Warning Port`. This extension can be used by the Terminal Translation Initialization (TTI) feature to assign a port to this extension from the port itself. Once `Calls Warning Port` is assigned a valid port (either via TTI or the **change hunt-group** command), then the extension is removed and considered unassigned.
- **Time Warning Threshold** — Enter the time in seconds (0 through 999, or blank) that a call can remain in the queue before the System flashes the Queue status lamps (feature buttons assigned members voice terminals) and the Auxiliary Queue Time Warning lamp assigned to this split/skill. An entry of "0" provides a warning whenever a call is queued.
- **(Time Warning) Port** — Enter the seven-character port number assigned to the Auxiliary Queue Time Warning lamp that flashes when the time entered in `Time Warning Threshold` has been reached by a call in queue. The entry breaks down as follows:

| Characters | Meaning        | Value         |
|------------|----------------|---------------|
| 1-2        | Cabinet Number | 01 through 44 |
|            |                | 01 through 03 |
|            |                | 01            |
| 3          | Carrier        | A through E   |
| 4-5        | Slot Number    | 01 through 20 |
| 6-7        | Circuit Number | 01 through 16 |

 **NOTE:**

This port is assigned to an Analog Line circuit pack or given an "X" designation if an extension is used.



- **(Time Warning) Extension** — An extension is needed when an X is placed in `Time Warning Port`. This extension can be used by the Terminal Translation Initialization (TTI) feature to assign a port to this extension from the port itself. Once `Time Warning Port` is assigned a valid port (either via TTI or the **change hunt-group** command), then the extension is removed and considered unassigned.

Page 2 of the Hunt group form is only displayed when `ACD?` on page 1 is set to **y**. If `ACD?` is set to **n**, page 3 becomes page 2 and all subsequent page numbers are decreased by one.

[Screen 5-67](#) shows page 2 of the form with all fields displayed.

### Page 2 of the form

Page 2 of X

HUNT GROUP

|                               |   |  |
|-------------------------------|---|--|
| Skill? _                      | Acceptable Service Level (sec): ___                 |  |
| AAS? _                        | Expected Call Handling Time (sec): ___              |  |
| Measured: _____               | VuStats Objective: _____                            |  |
| Supervisor Extension: _____   | Timed ACW Interval (sec): ___                       |  |
| Priority on Intraflow? _      | Service Level Supervisor? _                         |  |
| Inflow Threshold (sec): ___   | Level 1 Threshold (sec): ___                        |  |
| Controlling Adjunct: ___      | Level 2 Threshold (sec): ___                        |  |
| Adjunct Link Extension: _____ | Redirect on No Answer (rings): ___                  |  |
| Multiple Call Handling: _____ | Redirect to VDN: _____                              |  |
|                               | Forced Entry of Stroke Counts or Call Work Codes? _ |  |

Screen 5-67. Hunt Group form (page 2 of X)

### Implementation notes

Page 2 when the `Queue` and `Vector` fields are **n**.

Timed ACW Interval displays only if the Timed ACW option is enabled on page 3 of the System Parameters Customer-Option form.

Page 2 of X

```

                                HUNT GROUP
Skill? _                Acceptable Service Level (sec): ___
AAS? _                Expected Call Handling Time (sec): ___
Measured: _____
Supervisor Extension: _____    Timed ACW Interval (sec): ___
Priority on Intraflow? _
Controlling Adjunct: _____
Multiple Call Handling: _____    Redirect on No Answer (rings): ___
                                       Redirect to VDN: _____
Forced Entry of Stroke Counts or Call Work Codes? _
```

Screen 5-68. Hunt Group form (page 2 of X)

### Implementation notes

---

Page 2 when the Vector field is n and the Queue field is y.

Page 2 of X

```

                                HUNT GROUP
Skill? _                Acceptable Service Level (sec): ___
AAS? _                Expected Call Handling Time (sec): ___
Measured: _____
Supervisor Extension: _____
Priority on Intraflow? _
Inflow Threshold (sec): _____
Controlling Adjunct: _____

Multiple Call Handling: _____    Redirect on No Answer (rings): ___
                                       Redirect to VDN: _____
Forced Entry of Stroke Counts or Call Work Codes? _
```

Screen 5-69. Hunt Group form (page 2 of X)

### Implementation notes

---

Page 2 when Queue and Vector are y.

```

                                                                    Page 2 of X
HUNT GROUP
Skill? _ Acceptable Service Level (sec): ___
AAS? _ Expected Call Handling Time (sec): ___
Measured: internal VuStats Objective: ___
Supervisor Extension: ___
Service Level Supervisor? _
Controlling Adjunct: ___ Level 1 Threshold (sec): ___
Level 2 Threshold (sec): ___
Multiple Call Handling: _____ Redirect on No Answer (rings): ___
Redirect to VDN: ___
Forced Entry of Stroke Counts or Call Work Codes? _
  
```

Screen 5-70. Hunt Group form (page 2 of X)

The Vu Stats Objective field does not appear unless VuStats is enabled on the System-Parameters Customer-Options form and either **internal** or **both** is in the Measured field on this form.

Service Level Supervisor is displayed because the ACD and Skill fields are set to **y** and the CentreVu Advocate field on the System-Parameters Customer-Options form is set to **y**. The fields Level 1 Threshold (sec) and Level 2 Threshold (sec) are only displayed when Service Level Supervisor is set to **y**.

- **Skill** — Only appears if Expert Agent Selection is enabled on the System-Parameters Customer-Options form. Enter **y** if this hunt group is an EAS skill.



**NOTE:**

If this field is **y**, then Group Type must be **ucd** or **ead**.

- **AAS** — Displays when the ACD field for this hunt group is **y**. Enter **y** when this hunt group will serve as an Auto-Available Split.
- **Measured** — Enter **internal** to have measurement data for the ACD split/skill collected (internal to the switch) for VuStats or BCMS. This measurement data is collected for VuStats and BCMS only if they are optioned on the System-Parameters Customer-Options form. If you enter **internal** in the measured field and neither VuStats nor BCMS is optioned on the System-Parameters Customer-Options form, the system displays the following message:

<value> cannot be used; assign either BCMS or VuStats first

Contact a Lucent Technologies representative to assist with any changes you want to make on the System-Parameters Customer-Options form.

Enter **external** to have measurements made by the Call Management System (external to switch).

Enter **both** to have measurements collected both internally and externally.

Enter **none** (default) if measurement reports for this hunt group is not required.

- **Supervisor Extension** — Enter the extension number (cannot be a VDN number) of the ACD split/skill supervisor that agents will reach when using the Assist feature.
- **Priority On Intraflow** — Not displayed if `Vector` is **y**. Enter **y** if calls intraflowing from this split to a covering split will be given priority over other calls waiting in the covering split queue. Default is **n**.
- **Inflow Threshold** — Enter the number of seconds (**0** through **999**) that a call can remain in the queue before no more calls will be accepted by the queue. If **0** is entered, a call is redirected to this split/skill only if there is an available agent. This field displays only when `Vector` is **n** and `Queue` is **y**.
- **Controlling Adjunct** — Enter **none** to indicate that members of the split/skill or hunt group are not controlled by an adjunct processor. When set to **asai**, all agent logins are controlled by an associated adjunct and logged-in agents can only use their data terminal keyboards to perform voice terminal functions (for example, change work state). If the controlling adjunct is a CONVERSANT voice system (requires an ASAI link), then enter **asai** in this field. (The ASAI option must be enabled on the System-Parameters Customer-Option form for CallVisor ASAI capability.)
- **Adjunct Link Extension** — Displays when `Controlling Adjunct` is **asai** or **adjlk**. Enter the appropriate ASAI Link extension (see [“CallVisor Adjunct-Switch Application Interface” on page 4-250](#)). This field cannot be blank.
- **Multiple Call Handling** — Displays only if `Multiple Call Handling` on the System-Parameters Customer-Options form is set to **y**. This field defines whether the hunt group can have multiple call handling capabilities, and if so, what type. Valid entries are **none**, **on-request**, **many-forced**, **one-forced**, or **one-per-skill**. **One-Per-Skill** is only valid in an EAS environment and only when `Skills` is **y**. Default is **none**.
- **Acceptable Service Level (sec)** — Enter the number of seconds within which calls to this hunt group should be answered. This allows BCMS and/or VuStats to report a percentage of calls that were answered within the specified time. This entry is also used by the CentreVu® Advocate Service Objective feature. Valid entries are **0** through **9999** seconds. Default is 30.
- **Expected Call Handling Time (sec)** — This field appears only if either `Vectoring (Advanced Routing)` or `CentreVu Advocate` on the System-Parameters Customer-Options form is **y**. Enter a number from **1** to

**9999** to establish the number of seconds for expected call handling. This value is used to initialize Expected Wait Time and is also used by the CentreVu<sup>®</sup> Advocate Percent Allocation feature.

- **VuStats Objective** — Enter a numerical user-defined objective. An objective is a split or skill goal for the call. This could be an agent objective such as a specific number of calls handled or an average talk time. The objective could also be a percent within the service level. The objective appears on the VuStats display and allows agents and supervisors to compare the current performance against the value of the objective for the split or skill.

You can use this value in a customized VuStats display format if the value in the `Object Type` field on the VuStats display format form is either **agent**, **agent-extension**, or **split**.

This field appears only if `VuStats` is enabled on the System-Parameters Customer-Options form and either **internal** or **both** is entered in the `Measured` field on this form.

- **Timed ACW Interval** — When a value is entered in this field, an agent in auto-in work mode who receives an ACD call from this hunt group is placed automatically into After Call Work (ACW) when the call drops. Enter the number of seconds the agent should remain in ACW following the call. When the administered time is over, the agent automatically becomes available. Timed ACW cannot be administered if the hunt group is adjunct controlled, is an AUDIX Message Center, or is an auto-available split. `Timed ACW Interval` displays only if the Timed ACW option is enabled on page 3 of the System Parameters Customer-Option form.
- **Service Level Supervisor** — This feature is part of CentreVu<sup>®</sup> Advocate, an integrated software package for optimizing call center performance, and only appears if `CentreVu Advocate` is set to **y** on the System Parameters Customer-Options form and `Skill` is set to **y** on the Hunt Group form. For more information on CentreVu<sup>®</sup> Advocate, contact your Account Executive.
- **Level 1 Threshold (sec)** — This field is used with Service Level Supervisor and only appears if Service Level Supervisor is enabled.
- **Level 2 Threshold (sec)** — This field is used with Service Level Supervisor and only appears if Service Level Supervisor is enabled.
- **Redirect on No Answer (rings)** — Enter the maximum number of rings (1 to 20, or blank) before a call will redirect back to the split/skill, or to the administered VDN. Blank deactivates RONA.
- **Redirect to VDN** — To redirect a RONA call to a VDN instead of to the split/skill, enter the extension number of the VDN. The administered VDN must be on-premises and must be administered on the system. The VDN can specify a vector that will in turn route to an off-premises VDN. You cannot enter an extension in this field if `Redirection on No Answer (rings)` is blank. Direct Agent calls go to the agent's coverage path if it is administered. If not, the calls go to a VDN.

- **Forced Entry of Stroke Counts or Call Work Codes** — Displays only when `Controlling Adjunct` is **none**. Enter **y** if either a Stroke Count or Call Work Code must be entered for each call answered by an agent when in the Manual-In mode.

### Page 3 of the form

```

change hunt-group 1                                     Page 3 of 39
                                     HUNT GROUP
                                     Message Center: _____
                                     AUDIX Extension: _____
Message Center AUDIX Name: _____
                                     Primary? _
Calling Party Number to INTUITY AUDIX? _
                                     LWC Reception: _____
                                     AUDIX Name: _____
                                     Messaging Server Name: _____

First Announcement Extension: _____ Delay (sec): __
Second Announcement Extension: _____ Delay (sec): __ Recurring? _
    
```

### Screen 5-71. Hunt Group form (page 3 of X)

- **Message Center** — Enter the type of messaging adjunct for the hunt group. Valid entries are **msa** (Messaging Server Adjunct), **rem-audix** (DCS feature allowing AUDIX to be located on another switch), or **audix** (for AUDIX located on this switch). Entering **none** (default) indicates the hunt group does not serve as a message hunt group. Only one hunt group in the System can be administered as **msa**, one as **audix**, and one as **rem-audix**.
- **AUDIX Extension** — Displays when `Message Center` is **rem-audix**. Enter a valid 4- to 5-digit Uniform Dial Plan (UDP) extension that identifies the AUDIX hunt group on the host switch used as the Message Center for this hunt group (supports the AUDIX In DCS arrangement).
- **Message Center MSA Name** — Only appears on R5r and later configurations for hunt groups with `Message Center` set to **msa**. Enter the name of the Message Center MSA. (This field is not shown above. When displayed, it replaces `Message Center AUDIX Name`.)
- **Message Center AUDIX Name** — Only appears on R5r and later configurations for hunt groups with `Message Center` set to **audix** or **rem-audix**. Enter the name of the Message Center AUDIX.
- **Primary** — Only appears on R5r and later configurations for hunt groups with `Message Center` set to **audix**, **rem-audix**, or **msa**. Enter **y** to indicate that the specified AUDIX or Messaging Server is the primary adjunct.

- **Calling Party Number to INTUITY AUDIX** — Enter **y** to send the calling party number to INTUITY AUDIX. Enter **n** if you do not wish to communicate the calling party number to INTUITY AUDIX.
- **LWC Reception** — Defines the destination for Leave Word Calling (LWC) messages left for the hunt group. Valid entries are **audix**, **msa**, **spe**, or **none**.
- **AUDIX Name** — Only appears on R5r and later configurations. Enter the name of the AUDIX machine as it appears on the User-Defined Adjunct Names form.
- **Messaging Server Name** — Name of the server as it appears in the User-Defined Adjunct Names form. Only displayed for R5r and later configurations.
- **First Announcement Extension** — Displays when `Queue` is **y**. Not displayed if `Vector` is **y**. Enter a recorded announcement extension number or leave blank. This is the announcement the caller receives after being in the queue for the time interval specified in `First Announcement Delay`. If the call hasn't been answered after the announcement, the caller hears music (only after the first announcement) if Music-on-Hold is provided, or ringing for as long as it remains in the queue. Leaving this field blank indicates there will be no announcement. If this is the forced first announcement, the caller always hears ringback after the announcement; otherwise, the caller hears music (if provided).
- **First Announcement Delay (sec)** — Displays only if `Queue` is **y** and `Vector` is **n**. Enter the number of seconds (**0** through **99**) that a call remains in queue before the associated first announcement is given the calling party. The call retains its place in the queue while the caller is listening to the recorded announcement. If the call hasn't been answered after the announcement, the caller hears music (for first announcement only) if Music-on-Hold is provided or ringing for as long as the call remains in queue. When **0** is entered, the first announcement is provided immediately to the caller. This value is set automatically to **0** if there is no queue. This field must be blank if there is no first announcement.

The following fields display only when `ACD` and `Queue` both are **y** and `Vector` is **n**:

- **Second Announcement Extension** — Enter the extension number assigned to a recorded announcement or leave blank. Leaving the field blank indicates there is no second announcement.
- **Second Announcement Delay (sec)** — Enter the time in seconds (1 through 99) before the call in the queue receives a second recorded announcement or that the second announcement is repeated. It is recommended that, if this split/skill or hunt group is a coverage point for another split/skill, this delay should not be more than 15 seconds. Leave blank if there is no second announcement.

- **Second Announcement Recurring** — Enter **y** if the second announcement can be repeated. Leave blank if there is no second announcement.

**Pages 4 through X of the form**

```

change hunt-group 1                                     Page 4 of 39
                                     HUNT GROUP
      Group Number: 1      Group Extension: 3001      Group Type: ucd
      Member Range Allowed: 1 - 999      Administered Members (min/max): 1 /9
                                     Total Administered Members: 9
GROUP MEMBER ASSIGNMENTS
      Ext      Name
1: 1022 station 1022      14: 1023 station 1023
2: 1010 bri 1010
3: 1095 Station 1095
4: 1002 station 1002
5: 1001 Station 1001
6: 1053 stat x1053
7: 1094 Station 1094
8: 311 stat x311
9:
10:
11:
12:
13:
                                     15:
                                     16:
                                     17:
                                     18:
                                     19:
                                     20:
                                     21:
                                     22:
                                     23:
                                     24:
                                     25:
                                     26:
                                     27:

      At End of Member List
    
```

Screen 5-72. Hunt Group form (page 4 of X)

**NOTE:**

Only Pages 1, 2, and 3 display if the hunt group is skilled.

- **Group Number** — Display-only field
- **Group Extension** — Display-only field
- **Group Type** — Display-only field
- **Member Range Allowed** — The range of allowed members displays on all member pages. These values vary depending on the particular system and/or configuration.
- **Administered Members (min/max)** — Displays on all member pages. Indicates the minimum and maximum member number administered for this hunt group.
- **Total Administered Members** — Displays on all member pages. Indicates the total number of members administered for this hunt group.
- **More Members Exist** — Display-only field showing there are more members than currently displayed (the current page is not the last page).



- **At End of Member List** — Display-only field showing the current page is also the last page.
- **Ext** — Display-only field if Controlling Adjunct is **asai**. Controlled Agent extensions must be entered on the Adjunct Controlled Agent Table form. If Controlling Adjunct is "**none**," enter the extension number associated with a member in the hunt group or with an associated data module. The extension cannot be a VDN. The data module cannot be a member of an ACD split/skill.
- **Name** — Make no entry. This is a display-only field. The name is assigned to the above extension number when it is administered in the System.

## List Hunt Group form

| HUNT GROUPS |               |             |             |     |      |         |         |          |                |          |                |
|-------------|---------------|-------------|-------------|-----|------|---------|---------|----------|----------------|----------|----------------|
| Grp No.     | Grp Name/Ext. | Grp Grp Typ | ACD/MEAS    | Vec | MCH  | Que Siz | No. Mem | Cov Psth | Notif/ Ctg Adj | Dom Ctrl | Message Center |
| 1           | hu 1 3001     | meas vec    | ucd-mia y/R | y   | many | 5       | 4       |          | n              |          | n              |
| 2           | hu 2 3002     | meas vec    | ucd-mia n/- | y   | none | 5       | 11      |          | n              |          | n              |
| 33          | hu 33 3003    | non acd     | ucd-mia n/- | n   | none | S       | 5       | 1        | n              |          | n              |

### Screen 5-73. List Hunt Group form (page 1 of X)

- **Grp No.** — The number of a hunt group.
- **Grp Ext.** — The extension of the hunt group.
- **Name** — The name administered for the hunt group.
- **Grp Typ** — The type of the hunt group. See the `Group Type` field description for page 1 of the Hunt Group form.
- **ACD/MEAS** — Indicates whether the hunt group will function as an ACD split/skill (**y** or **n**) and how it is measured (**I**, **B**, or **N**). See the `ACD` and `Measured` field descriptions for Page 1 of the Hunt Group form.
- **Vec** — An indicator (**y** or **n**) of whether the hunt group is controlled by a vector. See the `Vector` field description for page 1 of the Hunt Group form.
- **MCH** — The MCH type assigned to the hunt group. Values are:
  - **none**
  - **req** for on-request
  - **one** for one-forced

- **per** for one-per-skill
- **many** for many-forced
- **Que Siz** — The maximum number of calls that can be in queue for the hunt group.
- **No. Mem** — The actual number of hunt group members.
- **Cov Path** — The number of the coverage path for the hunt group.
- **Notif/Ctg Adj** (Notifying/Controlling Adjunct) — An indicator of notification (**N**) or controlling adjunct (**C**), or none (**n**). If the `Notification` field displays **N**, it also contains the extension of the ASAI application link that has the notification. You can have up to three ASAI applications monitoring a single hunt group. If the field contains **C**, it also displays the extension of the controlling adjunct. You can have one controlling adjunct for each hunt group.
- **Dom Ctrl (Domain Control)** — Displays the extension of the ASAI link over which the domain split is set up.
- **Message Center** — An indicator of the type of message (if any) used. See the `Messaging Center` field description for page 2 of the Hunt Group form.

## Intercom Group

---

The Automatic and Dial Intercom features are available to users whose voice terminals have intercom feature button assignments. Members of an intercom group may have Dial Intercom, Automatic Intercom, both, or neither with respect to placing an Intercom call. Single-line voice terminals, if a member of the group, can receive an Intercom call, but cannot place an Intercom call.

This form specifies the group members, not the type of Intercom. (The intercom type and associated feature buttons are assigned to multi-appearance voice terminals using the multi-appearance voice terminal forms.)

### Administration commands

---

Use the following commands to administer the Intercom Group form.

| Action  | Object             | Qualifier <sup>1</sup>   |
|---------|--------------------|--|
| add     | intercom<br>-group | 1-MAX (or 'next')  |
| change  | intercom<br>-group | 1-MAX  |
| display | intercom<br>-group | 1-MAX ['print' or 'schedule']  |
| list    | intercom<br>-group | [1-MAX]['number' x]['to-number' x]['count' n]['print' or 'schedule'] |
| remove  | intercom<br>-group | 1-MAX  |

- 
1. Brackets [ ] indicate the qualifier is optional. Single quotes ( ' ' ) indicate the text inside the quote must be entered exactly as shown or an abbreviated form of the word may be entered. MAX is the number available in your system configuration.

### Form instructions

---

Make assignments as required for the following fields on each page of the form:

## Pages 1 and 2 of the form

```

change intercom-group 1                                     Page 1 of 2   SPE B
                                                           INTERCOM GROUP
                                                           Group Number: 1
                                                           Length of Dial Code: 1

GROUP MEMBER ASSIGNMENTS
  Ext   DC   Name
1: 1010  1   27 Character BRIsation1010
2:
3:
4:
5:
6:
7:
8:
9:
10:
11:
12:
13:
14: 1002  3   27 Character Station ex1002
15:
16:
    
```

### Screen 5-74. Intercom Group form (page 1 of 2)

- **Group Number** — Enter a Group number (1 to 3 digits) when completing a paper form. This is a display-only field when the form is accessed using an administration command such as **add** or **change**.
- **Length of Dial Code** — On Page 1, enter **1** or **2**. This is the number of digits that must be dialed to access someone in the group. Enter **1** (default) if group members are fewer than ten or "2" if group members are ten or more. (On Page 2, this is a display-only field.)
- **Ext** — Enter the extension number of each member of the group. VDN extensions are not allowed.
- **DC** — Enter a 1- or 2-digit code. The number of digits entered depends on the number assigned in **Length of Dial Code**. This field cannot be left blank. This is the code that must be dialed to access that group member.



**NOTE:**

If "2" was entered in **Length of Dial Code**, a 2-digit code must always be dialed. For example, to access member number 8 with a 2-digit dial code specified, "08" must be dialed.

- **Name** — Make no entry. The name is assigned when the member's associated extension was administered.

## Inter-Exchange Carrier (IXC) Codes

This form allows identification of the IXC in the CDR record.

### Administration commands

Use the following commands to administer the Inter-Exchange Carrier Codes form.

| Action  | Object    | Qualifier <sup>1</sup>  |
|---------|-----------|-------------------------|
| change  | ixc-codes | —                       |
| display | ixc-codes | ['print' or 'schedule'] |

1. Brackets [ ] indicate the qualifier is optional. Single quotes ( ' ') indicate the text inside the quote must be entered exactly as shown or an abbreviated form of the word may be entered.

### Form instructions

Make assignments as required for the following fields on each page of the form:

#### Page 1 of the form

Page 1 of 2

INTER-EXCHANGE CARRIER CODES

IXC Codes Assignments (Enter up to 15)

| CDR  | IXC    | IXC Name | CDR  | IXC    | IXC Name |
|------|--------|----------|------|--------|----------|
| Code | Number | IXC Name | Code | Number | IXC Name |
| 1:   | _____  | _____    | 9:   | _____  | _____    |
| 2:   | _____  | _____    | 10:  | _____  | _____    |
| 3:   | _____  | _____    | 11:  | _____  | _____    |
| 4:   | _____  | _____    | 12:  | _____  | _____    |
| 5:   | _____  | _____    | 13:  | _____  | _____    |
| 6:   | _____  | _____    | 14:  | _____  | _____    |
| 7:   | _____  | _____    | 15:  | _____  | _____    |
| 8:   | _____  | _____    |      |        |          |

5 Basic Forms  
Inter-Exchange Carrier (IXC) Codes

Page 5-178

- **IXC Access Number** — Enter the digits dialed or inserted by AAR/ARS into the outpulsed digit string to gain access to the interexchange carrier. No duplicate access numbers are allowed in the table.
- **IXC Name** — Enter 0 to 15 characters to identify the IXC. This description is for information purposes only.

Page 2 of the form

Page 2 of 2

|    | IXC Prefix | IXC Code Format |
|----|------------|-----------------|
| 1. | ___        | ___             |
| 2. | ___        | ___             |
| 3. | ___        | ___             |
| 4. | ___        | ___             |
| 5. | ___        | ___             |

Screen 5-76. Inter-Exchange Carrier Codes form (page 2 of 2)

- **IXC Prefix** — Enter a valid 1 to 3 digit prefix.
- **IXC Code Format** — Enter a valid 2 to 4 digit code format, or enter **x** or **X**.

## Interface Links

This form identifies, describes, and enables Interface Links. There is one Interface Link form per System. Interface Links provide a physical interface between the system and the other nodes in a DCS, ISDN, a Message Server Adjunct, a CMS, an ISDN Gateway adjunct (supports CPN/BN), or AUDIX.

### Administration commands

Use the following commands to access the Interface Links form.

| Action  | Object                  | Qualifier <sup>1</sup>        |
|---------|-------------------------|-------------------------------|
| change  | communication-interface | links                         |
| display | communication-interface | links ['print' or 'schedule'] |

1. Brackets [ ] indicate the qualifier is optional. Single quotes ( ' ') indicate the text inside the quote must be entered exactly as shown or an abbreviated form of the word may be entered.

### Form instructions

Page 1 of 1

INTERFACE LINKS

| Link | Enable | Est<br>Conn | PI<br>Ext | Port | Destination |     | DTE/<br>DCE | Identification |
|------|--------|-------------|-----------|------|-------------|-----|-------------|----------------|
|      |        |             |           |      | Digits      | Brd |             |                |
| 1:   | -      | -           | -         | -    | -           | -   | -           | -              |
| 2:   | -      | -           | -         | -    | -           | -   | -           | -              |
| 3:   | -      | -           | -         | -    | -           | -   | -           | -              |
| 4:   | -      | -           | -         | -    | -           | -   | -           | -              |
| 5:   | -      | -           | -         | -    | -           | -   | -           | -              |
| 6:   | -      | -           | -         | -    | -           | -   | -           | -              |
| 7:   | -      | -           | -         | -    | -           | -   | -           | -              |
| 8:   | -      | -           | -         | -    | -           | -   | -           | -              |

Link 1 [eia] - Connected to : \_\_\_\_\_ Clocking : \_\_\_\_\_

Screen 5-77. Interface Links form (R5si and later configurations) — Example Only

Page 1 of 1

| INTERFACE LINKS |         |                |                    |                      |                       |                |
|-----------------|---------|----------------|--------------------|----------------------|-----------------------|----------------|
| Link            | Enabled | X.25 Extension | Destination Number | Establish Connection | Connected Data Module | Identification |
| 1:              | -       | _____          | _____              | -                    | _____                 | _____          |
| 2:              | -       | _____          | _____              | -                    | _____                 | _____          |
| 3:              | -       | _____          | _____              | -                    | _____                 | _____          |
| 4:              | -       | _____          | _____              | -                    | _____                 | _____          |
| 5:              | -       | _____          | _____              | -                    | _____                 | _____          |
| 6:              | -       | _____          | _____              | -                    | _____                 | _____          |
| 7:              | -       | _____          | _____              | -                    | _____                 | _____          |
| 8:              | -       | _____          | _____              | -                    | _____                 | _____          |
| 9:              | -       | _____          | _____              | -                    | _____                 | _____          |
| 10:             | -       | _____          | _____              | -                    | _____                 | _____          |
| 11:             | -       | _____          | _____              | -                    | _____                 | _____          |
| 12:             | -       | _____          | _____              | -                    | _____                 | _____          |
| 13:             | -       | _____          | _____              | -                    | _____                 | _____          |
| 14:             | -       | _____          | _____              | -                    | _____                 | _____          |
| 15:             | -       | _____          | _____              | -                    | _____                 | _____          |
| 16:             | -       | _____          | _____              | -                    | _____                 | _____          |

Screen 5-78. Interface Links form (R5r and later configurations) — Example Only

Make assignments as required for the following fields on the form:

- **Link** — A display-only field. Indicates the interface link number that connects to another node in a DCS network, a Message Server, CMS, ISDN Gateway, or AUDIX. Interface Links always terminate on a port in a PGATE circuit pack for R5r and later configurations or on the PI circuit pack for R5si configurations.
- **Enable** — Enter **y** to enable the link. Enter **n** (default) to suppress any message flow over the link.
- **Est Conn** — Displays for R5si and later configurations only. Enter **y** if the System is responsible for any part of the call setup required for the link between the System and the far-end data module.

If the physical link is through a pair of MPDMs or MTDMs, then each switch terminating the link must set up a connection between its Processor Interface Data Module and MPDM/MTDM.

If the physical link is over a DS1 interface, it is possible (except for ISDN signaling links) for one switch to set up the entire connection (see Destination below). In this case, the other switch will not initiate any part of the connection between the two endpoints. Typically when using a DS1 interface, the **Enable** field is **y** on both the originating and terminating switches but only one link between the two switches will have **Est Conn** set to **y**. The originating switch is defined as having **Est Conn** set to **y**.

If the link is to be used for ISDN signaling, enter **y**.



- **X.25 Extension** — Displays for R5r and later configurations only. Automatically displays the extension of a previously administered X.25 data module connected to the Adjunct.
- **PI Ext** — Displays for R5si and later configurations only. This is the data extension assigned on the Processor Interface Data Module form. This is a display-only field. If the data module has not been administered, this field will be blank.
- **Destination Number** — Displays for R5r and later configurations only. To connect the Adjunct via the cable on the back of the PGATE circuit pack, enter **external**.



**NOTE:**

If a value other than **external** is used, the associated X.25 data module must have a baud rate of **switched**.

This field can be left blank assuming the other side will call it; however, it is equivalent and preferable to put in the actual digits of the other side and set *Establish Connection* to **n**. This allows you to identify which X.25 data module on the remote switch is expected to call this data module.

- **Prot** — Displays for R5si and later configurations only. Enter the protocol type that is to be established on the link. Valid entries are **bx.25** (default), and **isdn**.
- **Establish Connection** — Displays for R5r and later configurations only. This field displays when a string of digits is entered in *Destination Number*. Enter **y** if the System is responsible for any part of the call setup required for the link between the System and the far-end data module.
- **Destination** — Displays for R5si and later configurations only. Leave blank if the System is not involved in establishing any part of the connection (may not be a VDN extension).

For BX.25 links [allowable entries are extension number, **TAC** (for DS1 data link), or **eia** (link 1 only)]:



**NOTE:**

An **eia** entry is valid only for Simplex systems.

- Enter the extension number in the Digits field that is used to set up a connection or part of a connection between the local and far-end data modules for the link.
- If the BX.25 link is through a pair of PDMs or TDMs, then use the extension of the PDM/TDM as the destination address.
- If the BX.25 link is through a DS1 interface and the local switch is establishing the connection, enter the TAC if the far-end trunk group is administered with an incoming destination (for example, the far-end data module extension). Otherwise, enter the TAC followed by the far-end data module extension.

For ISDN links:

- Enter the DS1 circuit pack address previously administered as using ISDN signaling in the `Brd` field.

If the last channel on the DS1 circuit pack is used for Facility Associated Signaling, it cannot be administered as a member of the trunk group. A DS1 circuit pack address can only appear once as a destination address on the form. Allowable entries are the 5-character DS1 circuit pack location. The first character identifies the network (1 through 3, default is 1 if no entry); the second character identifies the carrier (A through E); the third and fourth characters identify the slot number in the carrier (01 through 20 for multi-carrier cabinets depending on carrier type or 01 through 18 for single-carrier cabinets depending on cabinet type).

- **Connected Data Module** — Displays for R5r and later configurations only.
- **DTE/DCE** — Displays for R5si and later configurations only. Enter **DTE** (default) or **DCE** to define the type of interface. This field is only administrable if `Prot` is **bx.25**. If one endpoint of a link is DTE, then the other must be DCE, and vice versa. The assignments must be coordinated on a network-wide level. Endpoint Switch Links are generally DTE and Tandem links are generally DCE. If both endpoints are of the same type (that is, endpoints or tandem), then the assignment of which is DTE and which is DCE is arbitrary. Typically, when using a DS1 interface, the originating switch should be administered as **DTE** and the terminating switch as **DCE**.
- **Identification** — Enter a 15-character name for the link. Used for identification purposes only. It may be used to identify the destination machine or left blank.
- **Link 1 [eia] — Connected to** — Displays only when **eia** is entered in `Destination` and applies only to Link 1. This field defines the physical characteristics of the device connected to the `eia` port and only refers to the physical layer of the protocol (which lines send and receive data, and so on) and not to the link layer which is controlled by the DTE/DCE field. Valid entries are **dte** and **dce** (default).
- **Clocking** — Displays only when **eia** is entered in `Destination` and applies only to Link 1. This field sets the clocking for the physical layer of the protocol. Entering **internal** states the clocking is provided by the `eia` port, and **external** (default) states that clocking is provided by the other end of the link. One end of the link should be set to **internal** and the other end should be set to **external**.

## Intra-Switch CDR

---

This form administers extensions for which Intra-Switch CDR is to be enabled.

 **NOTE:**

Attendants are not allowed to be optioned for the Intra-Switch CDR feature.

### Administration commands

---

Use the following commands to administer the Intra-Switch CDR form.

| Action  | Object           | Qualifier <sup>1</sup>             |
|---------|------------------|------------------------------------|
| add     | intra-switch-cdr |                                    |
| change  | intra-switch-cdr | [extension]                        |
| display | intra-switch-cdr | [extension]['print' or 'schedule'] |
| list    | intra-switch-cdr | [extension][count x]               |

- 
1. Brackets [ ] indicate the qualifier is optional. Single quotes ( ' ' ) indicate the text inside the quote must be entered exactly as shown or an abbreviated form of the word can be entered.

If your system can record more than 100 stations (see ["Capacities"](#) below), the system only displays two pages of extensions (112 per page) at one time. When you enter the add command to add extensions, the system automatically begins after the last administered extensions. If you enter the change command, the system display begins with the first extension. If you enter the change command with an extension number, the system begins the display with that extension.

When you enter the command list intra-switch-cdr <extension> count x, the system lists "x" switch extensions administered for Intra-Switch CDR beginning with the extension specified by <extension>. For example, if you enter "list intra-switch-cdr 81000 count 500," the system displays extension 81000 (if it is administered for Intra-Switch CDR) and the next 500 extensions that are administered for Intra-Switch CDR. The display command functions similarly to the change command.

### Capacities

The Intra-Switch CDR extension capacities vary from switch to switch. See the *DEFINITY Enterprise Communications Server Release 6 System Description Pocket Reference*.

### Form instructions

---

Make assignments as required for the following fields on each page of the form:

### Page 1 of X of the Add/Change/Display form

- **Assigned Members** — The number of extensions administered out of the switch version maximum. To add the Intra-Switch CDR feature to additional extensions, enter the extension number(s) on this form.

Page 1 of 1

INTRA-SWITCH CDR

Assigned Members: 2 of 100 administered

|     |       |     |       |     |       |     |       |     |       |     |       |      |       |
|-----|-------|-----|-------|-----|-------|-----|-------|-----|-------|-----|-------|------|-------|
| 1:  | 72447 | 17: | _____ | 33: | _____ | 49: | _____ | 65: | _____ | 81: | _____ | 97:  | _____ |
| 2:  | 72448 | 18: | _____ | 34: | _____ | 50: | _____ | 66: | _____ | 82: | _____ | 98:  | _____ |
| 3:  | _____ | 19: | _____ | 35: | _____ | 51: | _____ | 67: | _____ | 83: | _____ | 99:  | _____ |
| 4:  | _____ | 20: | _____ | 36: | _____ | 52: | _____ | 68: | _____ | 84: | _____ | 100: | _____ |
| 5:  | _____ | 21: | _____ | 37: | _____ | 53: | _____ | 69: | _____ | 85: | _____ |      |       |
| 6:  | _____ | 22: | _____ | 38: | _____ | 54: | _____ | 70: | _____ | 86: | _____ |      |       |
| 7:  | _____ | 23: | _____ | 39: | _____ | 55: | _____ | 71: | _____ | 87: | _____ |      |       |
| 8:  | _____ | 24: | _____ | 40: | _____ | 56: | _____ | 72: | _____ | 88: | _____ |      |       |
| 9:  | _____ | 25: | _____ | 41: | _____ | 57: | _____ | 73: | _____ | 89: | _____ |      |       |
| 10: | _____ | 26: | _____ | 42: | _____ | 58: | _____ | 74: | _____ | 90: | _____ |      |       |
| 11: | _____ | 27: | _____ | 43: | _____ | 59: | _____ | 75: | _____ | 91: | _____ |      |       |
| 12: | _____ | 28: | _____ | 44: | _____ | 60: | _____ | 76: | _____ | 92: | _____ |      |       |
| 13: | _____ | 29: | _____ | 45: | _____ | 61: | _____ | 77: | _____ | 93: | _____ |      |       |
| 14: | _____ | 30: | _____ | 46: | _____ | 62: | _____ | 78: | _____ | 94: | _____ |      |       |
| 15: | _____ | 31: | _____ | 47: | _____ | 63: | _____ | 79: | _____ | 95: | _____ |      |       |
| 16: | _____ | 32: | _____ | 48: | _____ | 64: | _____ | 80: | _____ | 96: | _____ |      |       |

### Screen 5-79. Intra-Switch CDR form for R5vs and later and R5si and later

Page 1 of 2

INTRA-SWITCH CDR

Assigned Members: 2 of 1000 administered

|     |       |     |       |     |       |     |       |     |       |     |       |      |       |
|-----|-------|-----|-------|-----|-------|-----|-------|-----|-------|-----|-------|------|-------|
| 1:  | 72447 | 17: | _____ | 33: | _____ | 49: | _____ | 65: | _____ | 81: | _____ | 97:  | _____ |
| 2:  | 72448 | 18: | _____ | 34: | _____ | 50: | _____ | 66: | _____ | 82: | _____ | 98:  | _____ |
| 3:  | _____ | 19: | _____ | 35: | _____ | 51: | _____ | 67: | _____ | 83: | _____ | 99:  | _____ |
| 4:  | _____ | 20: | _____ | 36: | _____ | 52: | _____ | 68: | _____ | 84: | _____ | 100: | _____ |
| 5:  | _____ | 21: | _____ | 37: | _____ | 53: | _____ | 69: | _____ | 85: | _____ | 101: | _____ |
| 6:  | _____ | 22: | _____ | 38: | _____ | 54: | _____ | 70: | _____ | 86: | _____ | 102: | _____ |
| 7:  | _____ | 23: | _____ | 39: | _____ | 55: | _____ | 71: | _____ | 87: | _____ | 103: | _____ |
| 8:  | _____ | 24: | _____ | 40: | _____ | 56: | _____ | 72: | _____ | 88: | _____ | 104: | _____ |
| 9:  | _____ | 25: | _____ | 41: | _____ | 57: | _____ | 73: | _____ | 89: | _____ | 105: | _____ |
| 10: | _____ | 26: | _____ | 42: | _____ | 58: | _____ | 74: | _____ | 90: | _____ | 106: | _____ |
| 11: | _____ | 27: | _____ | 43: | _____ | 59: | _____ | 75: | _____ | 91: | _____ | 107: | _____ |
| 12: | _____ | 28: | _____ | 44: | _____ | 60: | _____ | 76: | _____ | 92: | _____ | 108: | _____ |
| 13: | _____ | 29: | _____ | 45: | _____ | 61: | _____ | 77: | _____ | 93: | _____ | 109: | _____ |
| 14: | _____ | 30: | _____ | 46: | _____ | 62: | _____ | 78: | _____ | 94: | _____ | 110: | _____ |
| 15: | _____ | 31: | _____ | 47: | _____ | 63: | _____ | 79: | _____ | 95: | _____ | 111: | _____ |
| 16: | _____ | 32: | _____ | 48: | _____ | 64: | _____ | 80: | _____ | 96: | _____ | 112: | _____ |

### Screen 5-80. Intra-Switch CDR form for R5r and later

## Implementation notes

---

If your configuration allows more than 112 trackable extensions, this will be a multipage form.

### Page 1 of X of the List form

| INTRA-SWITCH CDR |                             |              |             |
|------------------|-----------------------------|--------------|-------------|
| Extension        | Type                        | Name         |             |
| -----            | -----                       | -----        |             |
| 56001            | station-user                | 27 character | dr06-1c1101 |
| 56002            | station-user                | dr06-1c1102  |             |
| 56098            | terminating-extension-group | TEG 1        |             |
| 56311            | station-user                | dr6-1c0702   |             |

### Screen 5-81. Intra-Switch CDR form

- **Extension** — The extensions administered for Intra-Switch CDR
- **Type** — A user-defined description of the extension
- **Name** — A user-defined name associated with the extension

## ISDN-BRI Trunk Circuit Pack

---

This form administers an ISDN-BRI circuit pack. See *DEFINITY ECS System Description Pocket Reference* for information on the maximum number of ISDN-BRI circuit packs that you can administer.

### Administration commands

---

Use the following commands to administer the BRI Trunk Circuit Pack form.

| Action  | Object          | Qualifier <sup>1</sup>  |
|---------|-----------------|-------------------------|
| add     | bri-trunk-board | PPCSS <sup>2</sup>      |
| change  | bri-trunk-board | PPCSS                   |
| display | bri-trunk-board | ['print' or 'schedule'] |
| remove  | bri-trunk-board | PPCSS                   |

- 
1. Brackets [ ] indicate the qualifier is optional. Single quotes ( ' ) indicate the text inside the quote must be entered exactly as shown or an abbreviated form of the word may be entered.
  2. PP — representing two-digit port network number, C — representing one-digit carrier identification, SS — representing two-digit slot number.

### Form instructions

---

Make assignments, as required, for the following fields on each page of the form.

## Page 1 of the form

```
Page 1 of 1
```

```
ISDN-BRI TRUNK CIRCUIT PACK
```

Location: 01A09                                Name: \_\_\_\_\_

Interface Companding: a-law\_    DCP/Analog Bearer Capability: 3.1kHz

T3 Timer Length (sec): 15\_

| Port | Interface    | Side | Cntry/Peer<br>Protocol | TEI  | Time<br>Fill | Invert<br>Bits? | Synch<br>Source? | Layer 1<br>Stable? | Detect<br>Slips? |
|------|--------------|------|------------------------|------|--------------|-----------------|------------------|--------------------|------------------|
| 1:   | user_____    |      | 12_                    | 0_   | flags        | n               | n                | n                  | n                |
| 2:   | network_____ |      | etsi                   | 0_   | ones_        | y               | y                | y                  | y                |
| 3:   | user_____    |      | 2_                     | auto | flags        | y               | n                | y                  | n                |
| 4:   | peer-slave_  | b    | QSIG                   | 0_   | flags        | n               | y                | y                  | n                |
| 5:   | peer-master  | a    | QSIG                   | auto | ones_        | n               | n                | n                  | n                |
| 6:   | _____        |      | _____                  | 0_   | ones_        | n               | n                | y                  | n                |
| 7:   | _____        |      | _____                  | 0_   | ones_        | n               | n                | y                  | n                |
| 8:   | _____        |      | _____                  | 0_   | ones_        | n               | n                | y                  | n                |

## Screen 5-82. BRI Trunk Form (using a TN2185 circuit pack)

- **Location** — A display-only field showing the TN2185 circuit pack location (PPCSS)
- **Name** — A 15-character alpha-numeric identification that may be used to identify the circuit pack. Default is blank.
- **Interface Companding** — Indicates the companding algorithm expected by the system at the far end. Valid entries are **a-law** (default) or **mu-law**. Blank is not a valid entry.
- **DCP/Analog Bearer Capability** — Indicates how to encode the Bearer Capability IE for an outgoing call originated by a DCP or analog endpoint. Valid entries are **3.1kHz** (default) or **speech**. Blank is not a valid entry.
- **T3 Timer Length (sec)** — Tells the TE side how long to wait for an inactive Layer 1 to become active. Valid entries are 1 through 127 seconds in increments of 1 second. Default is **15**. Blank is not a valid entry.
- **Port** — A display-only field showing the port number to which parameters administered on the row apply.
- **Interface** — Tells call processing software whether a particular port is connected to a user/network or a peer interface. Valid entries for TN2185 are **network**, **user**, **peer-master**, **peer-slave** (can enter only if the QSIG Basic Call Setup feature is enabled), or blank (default).
- **Side** — Determines how glare conditions are handled when Interface field is peer-slave. Valid entries are **a** and **b**. Blank is not a valid entry.

5 Basic Forms

ISDN-BRI Trunk Circuit Pack

Page 5-188

- **Cntry/Peer Protocol** — Tells call processing software which ISDN protocol standard is applied. Valid entries are **1** through **23**, **etsi**, **QSIG**, or blank (default - however, you cannot leave this field blank if the `Interface` field is set to a valid, non-blank value). When the `Interface` field is **peer-slave** or **peer-master**, this field must be **QSIG**. When this field is **10**, **12**, **13**, or **etsi**, the `Protocol Version` field is equivalent to **b** on the DS1 circuit pack form.

The choice **QSIG** is valid only when `Interface` is **peer-slave**. When **Cntry/Peer Protocol** is set to **10**, **12**, **13**, or **etsi**, set `Provol Version` to **b**. For all other administered values, the `Protocol Version` sets to **a**.

- **TEI** — Valid entries are **auto** and **0** (default).
- **Time Fill** — The bit pattern sent on the D-channel between valid LAPD packets. Valid entries are **flags** and **ones** (default). Blank is not a valid entry.
- **Invert Bits** — Valid entries are **y** and **n** (default). Blank is not a valid entry.
- **Synch Source** — Valid entries are **y** and **n** (default). Blank is not a valid entry.
- **Layer 1 Stable** — Tells call processing and maintenance software whether to expect the network to drop Layer 1 when the BRI port is idle. Valid entries are **n** and **y** (default). Blank is not a valid entry. Only the TN2185 may be set to **n**.
- **Detect Slips** — Tells maintenance software whether slips reported by the BRI port should be logged. Valid entries are **y** and **n** (default). Blank is not a valid entry.



Page 1 of the form

```

Page 1 of 1

ISDN-BRI TRUNK CIRCUIT PACK

Location: 01A09 Name: _____
Interface Companding: a-law_ DCP/Analog Bearer Capability: 3.1kHz

Port  Interface  Side  Cntry/Peer  TEI  Time Invert
      Interface  Side  Protocol    Fill  Bits?
1:   network__   _____  12__   0__  flags  n
2:   network__   _____  etsi   0__  ones_  y
3:   network__   _____  2__   auto  flags  y
4:   peer-master b   _____  QSIG  0__  flags  n
5:   peer-master a   _____  QSIG  auto  ones_  n
6:   _____  _____  _____  0__  ones_  n
7:   _____  _____  _____  0__  ones_  n
8:   _____  _____  _____  0__  ones_  n
9:   _____  _____  _____  0__  ones_  n
10:  _____  _____  _____  0__  ones_  n
11:  _____  _____  _____  0__  ones_  n
12:  _____  _____  _____  0__  ones_  n
  
```

Screen 5-83. BRI Trunk form (with a TN556B or TN2198 circuit pack)

Fields unique to this form

The following fields do not display with a TN556B or TN2198 circuit pack:

- T3 Timer Length (sec)
- Synch Source
- Layer 1 Stable
- Detect Slips

The following field descriptions are unique to the ISDN-BRI Circuit Pack form with a TN556B or TN2198 circuit pack:

- **Interface** — Tells call processing software whether a particular port is connected to a user/network or a peer interface. Valid entries for TN556B are **network**, **peer-master** (can enter only if the QSIG Basic Call Setup feature is enabled), or blank (default).
- **Side** — Determines how glare conditions are handled when Interface field is peer-slave. Valid entries are **a** (default) and **b**. Blank is not a valid entry. This field is not administrable when Interface is **network**.
- **Cntry/Peer Protocol** — Tells call processing software which ISDN protocol standard is applied. Valid entries are **1** through **23**, **etsi**, **QSIG**, or blank (default - however, you cannot leave this field blank if the Interface field is set to a valid, non-blank value). When the Interface

field is **peer-master**, this field must be **QSIG**. When this field is **10, 12, 13**, or **etsi**, the Protocol Version field is equivalent to **b** on the DS1 circuit pack form.

Page 2 of the form

 **NOTE:**  
 If administering a TN2185 circuit pack, 8 ports appear; otherwise, 12 ports appear.

Page 2 of 2

ISDN-BRI TRUNK CIRCUIT PACK

| Port | XID<br>Test? | Endpt<br>Init? | SPID       | Endpt<br>ID | Max<br>NCA TSC |
|------|--------------|----------------|------------|-------------|----------------|
| 1:   | y            | n              | _____      | —           | —              |
| 2:   | y            | y              | 9089572000 | —           | —              |
| 3:   | y            | y              | 0001_____  | —           | —              |
| 4:   | n            | n              | _____      | —           | —              |
| 5:   | n            | y              | 625761449_ | 01          | —              |
| 6:   | n            | n              | _____      | —           | —              |
| 7:   | n            | n              | _____      | —           | —              |
| 8:   | n            | n              | _____      | —           | —              |
| 9:   | n            | n              | _____      | —           | —              |
| 10:  | n            | n              | _____      | —           | —              |
| 11:  | n            | n              | _____      | —           | —              |
| 12:  | n            | n              | _____      | —           | —              |

Screen 5-84. BRI Trunk Form - Page 2 (using a TN2185 circuit pack)

 **NOTE:**  
 You cannot change the Endpt Init and SPID port parameters unless that port is busied out or unadministered. It is possible to change all other fields on this page even if the corresponding port is active.

 **NOTE:**  
 If *Interface* on page 1 contains a valid value when the form is submitted, the contents of the fields on page 2 for that port are validated. If *Interface* is blank when the form is submitted, the fields on this page for that port reset to their default values.

- **Port** — A display-only field showing the port number to which parameters administered on the row apply.
- **XID Test** — Indicates whether the far end supports the Layer 2 XID test. Valid entries are **y** and **n** (default). Blank is not a valid entry.

- **Endpt Init** — Indicates whether the far end supports endpoint initialization. Valid entries are **y** and **n** (default). Blank is not a valid entry. If set to **n**, *SPID* and *Endpt ID* must be blank. If set to **y**, *SPID* must be blank. DEFINITY ECS blocks you from changing this field and the *SPID* field unless that port is busied out or unadministered.
- **SPID** — A 12-digit field containing the SPID expected by the far end. Valid entries are any string of 1 to 12 digits with leading zeroes considered significant and not ignored, or blank (default). DEFINITY ECS blocks you from changing this field and the *Endpt Init* field unless that port is busied out or unadministered. The only protocol supported for SPID initialization is Bellcore (Country Code 1). Trunks will not be put in service if SPID installation is not successful.
- **Endpt ID** — A 2-digit field containing the Endpoint Identifier expected by the far end. Valid entries are from **00** to **62** with leading zeroes considered significant and not ignored, or blank (default).
- **Max NCA TSC** — A 2-digit field giving the maximum number of Non-Call-Associated Temporary Signaling Connections allowed on this BRI D-channel. (This field's function is the same as the like-name field on the Signaling Group form.) Valid entries are **0** through **63**. Default is **0**. Blank is not a valid entry.

## Trunk Member Administration

Administer BRI trunk members using the following scheme to address the individual B-channels:

- B-channel 1 uses the port address of the BRI Trunk Port.
- B-channel 2 uses the port address of B-channel 1 incremented by 16.

When adding a BRI trunk to an isdn trunk-group, DEFINITY ECS blocks you from administering a Signaling Group for that trunk member.

DEFINITY ECS blocks you from administering a BRI trunk member if the port has not yet been administered on the BRI Trunk form.

For example, administer the B-channels on a TN2185 circuit pack inserted in slot 01A10 as follows:

| Port | B-channel 1 | B-channel 2 |
|------|-------------|-------------|
| 1    | 01A1001     | 01A1017     |
| 2    | 01A1002     | 01A1018     |
| 3    | 01A1003     | 01A1019     |
| 4    | 01A1004     | 01A1020     |

|   |         |         |
|---|---------|---------|
| 5 | 01A1005 | 01A1021 |
| 6 | 01A1006 | 01A1022 |
| 7 | 01A1007 | 01A1023 |
| 8 | 01A1008 | 01A1024 |

## Interactions

---

The **add bri-trunk board PPCSS** command is rejected if PPCSS identifies a TN556B circuit pack, and a port on that circuit pack has already been assigned to a station or data-module. If a TN556B circuit pack has been administered as a BRI trunk circuit pack, any port on that circuit pack is prevented from being assigned to a station or data-module.

## Language Translations

These forms administer a "user-defined" language for display messages. This allows a user-customized language to be added to the four languages (English, French, Italian, and Spanish) provided with the System.

Only Roman letters, punctuation, and digits are accepted (blanks are also acceptable). Diacritical marks are not supported.

### NOTE:

If "user-defined" is selected for the display language and no translations have been made on these forms, all display messages will appear as a string of asterisks.

### Administration commands

Use the following commands to administer the Language Translations forms.

| Action  | Object                                  | Qualifier <sup>1</sup>  |
|---------|---|-------------------------|
| change  | display-messages auto-wakeup-dn-dst     | —                       |
| display | display-messages auto-wakeup-dn-dst     | ['print' or 'schedule'] |
| change  | display-messages call-identifiers       | —                       |
| display | display-messages call-identifiers       | ['print' or 'schedule'] |
| change  | display-messages date-time              | —                       |
| display | display-messages date-time              | ['print' or 'schedule'] |
| change  | display-messages leave-word-calling     | —                       |
| display | display-messages leave-word-calling     | ['print' or 'schedule'] |
| change  | display-messages malicious-call-trace   | —                       |
| display | display-messages malicious-call-trace   | ['print' or 'schedule'] |
| change  | display-messages miscellaneous-features | —                       |
| display | display-messages miscellaneous-features | ['print' or 'schedule'] |
| change  | display-messages property-management    | —                       |
| display | display-messages property-management    | ['print' or 'schedule'] |
| change  | display-messages softkey-labels         | —                       |
| display | display-messages softkey-labels         | ['print' or 'schedule'] |
| change  | display-messages time-of-day-routing    | —                       |
| display | display-messages time-of-day-routing    | ['print' or 'schedule'] |

1. Brackets [ ] indicate the qualifier is optional. Single quotes ( ' ') indicate the text inside the quote must be entered exactly as shown or an abbreviated form of the word can be entered.

### Form instructions

---

Make assignments as required for the following fields on the form:

- **English** — Display-only field. This field contains the English term to be translated.
- **Meaning of English term** — Display-only field. Only appears on certain forms. This field contains a short explanation of the English message if that message is an abbreviation.
- **Translation** — Enter the desired translation for the corresponding English term.

Page 1 of 3

LANGUAGE TRANSLATIONS

1. English: AUTO WAKEUP - Ext:  
Translation: \*\*\*\*\*;

2. English: WAKEUP ENTRY DENIED  
Translation: \*\*\*\*\*

3. English: WAKEUP REQUEST CANCELED  
Translation: \*\*\*\*\*

4. English: WAKEUP REQUEST CONFIRMED  
Translation: \*\*\*\*\*

5. English: Wakeup Call  
Translation: \*\*\*\*\*

6. English: Time:  
Translation: \*\*\*\*\*

Screen 5-85. Language Translations — Auto-Wakeup-Dn-Dst form (page 1 of 3)

LANGUAGE TRANSLATIONS

- 7. English: DO NOT DIST - Ext:  
Translation: \*\*\*\*\*
- 8. English: DO NOT DIST - Group:  
Translation: \*\*\*\*\*
- 9. English: DO NOT DIST ENTRY DENIED  
Translation: \*\*\*\*\*
- 10. English: THANK YOU - DO NOT DIST ENTRY CONFIRMED  
Translation: \*\*\*\*\*
- 11. English: THANK YOU - DO NOT DIST REQUEST CANCELED  
Translation: \*\*\*\*\*

Screen 5-86. Language Translations — Auto-Wakeup-Dn-Dst form (page 2 of 3)

LANGUAGE TRANSLATIONS

- 12. English: INTERVAL FULL  
Translation: \*\*\*\*\*
- 13. English: NO PERMISSION  
Translation: \*\*\*\*\*
- 14. English: SYSTEM FULL  
Translation: \*\*\*\*\*
- 15. English: TOO SOON  
Translation: \*\*\*\*\*
- 16. English: INVALID EXTENSION - TRY AGAIN  
Translation: \*\*\*\*\*
- 17. English: INVALID GROUP - TRY AGAIN  
Translation: \*\*\*\*\*

Screen 5-87. Language Translations — Auto-Wakeup-Dn-Dst form (page 3 of 3)

| LANGUAGE TRANSLATIONS |   |     | Page 1 of 4     |
|-----------------------|---|-----|-----------------|
| English Term          | Meaning of English term                   |     | Translated Term |
| 1. sa                 | ACD Supervisor Assistance                 | 1:  | **              |
| 2. ac                 | Attendant Assistance Call                 | 2:  | **              |
| 3. tc                 | Attendant Control Of A Trunk Group        | 3:  | **              |
| 4. an                 | Attendant No Answer                       | 4:  | **              |
| 5. pc                 | Attendant Personal Call                   | 5:  | **              |
| 6. rc                 | Attendant Recall Call                     | 6:  | **              |
| 7. rt                 | Attendant Return Call                     | 7:  | **              |
| 8. sc                 | Attendant Serial Call                     | 8:  | **              |
| 9. co                 | Controlled Outward Restriction            | 9:  | **              |
| 10. cs                | Controlled Station To Station Restriction | 10: | **              |
| 11. ct                | Controlled Termination Restriction        | 11: | **              |
| 12. db                | DID Find Busy Station With CO Tones       | 12: | **              |
| 13. da                | DID Recall Go To Attendant                | 13: | **              |
| 14. qf                | Emergency Queue Full Redirection          | 14: | **              |
| 15. hc                | Held Call Timed Reminder                  | 15: | **              |

Screen 5-88. Language Translations — Call-Identifiers form (page 1 of 4)

| LANGUAGE TRANSLATIONS |                                   |     | Page 2 of 4     |
|-----------------------|-----------------------------------|-----|-----------------|
| English Term          | Meaning of English term           |     | Translated Term |
| 16. ic                | Intercept                         | 16: | **              |
| 17. ip                | Interposition Call                | 17: | **              |
| 18. ld                | LDN Calls On DID Trunks           | 18: | **              |
| 19. so                | Service Observing                 | 19: | **              |
| 20. na                | Unanswered Or Incomplete DID Call | 20: | **              |
| 21. ACB               | Automatic Callback                | 21: | *****           |
| 22. callback          | Callback Call                     | 22: | *****           |
| 23. park              | Call Park                         | 23: | *****           |
| 24. control           | Control                           | 24: | *****           |
| 25. ICOM              | Intercom Call                     | 25: | *****           |
| 26. OTQ               | Outgoing Trunk Queuing            | 26: | *****           |
| 27. priority          | Priority Call                     | 27: | *****           |
| 28. recall            | Recall Call                       | 28: | *****           |
| 29. return            | Return Call                       | 29: | *****           |
| 30. ARS               | Automatic Route Selection         | 30: | *****           |

Screen 5-89. Language Translations — Call-Identifiers form (page 2 of 4)



5 Basic Forms

Language Translations

LANGUAGE TRANSLATIONS

| English Term | Meaning of English term                    | Translated Term |
|--------------|--|-----------------|
| 31. forward  | Call Forwarding                            | 31: *****       |
| 32. cover    | Cover                                      | 32: *****       |
| 33. DND      | Do Not Disturb                             | 33: *****       |
| 34. p        | Call Pickup                                | 34: *           |
| 35. c        | Cover All Calls                            | 35: *           |
| 36. n        | Night Station Service, Including No Answer | 36: *           |
| 37. B        | All Calls Busy                             | 37: *           |
| 38. f        | Call Forwarding                            | 38: *           |
| 39. b        | Cover Busy                                 | 39: *           |
| 40. d        | Cover Don't Answer                         | 40: *           |
| 41. s        | Send All Calls                             | 41: *           |
| 42. to       | <calling party> to <called party>          | 42: **          |
| 43. VDN      | Vector Directory Number                    | 43: ***         |
| 44. hunt     | Station Hunting, Origination               | 44: *****       |
| 45. h        | Station Hunting, Termination               | 45: *           |

Screen 5-90. Language Translations — Call-Identifiers form (page 3 of 4)

LANGUAGE TRANSLATIONS

| English Term     | Meaning of English term              | Translated Term |
|------------------|--------------------------------------|-----------------|
| 46. OPERATOR     | Operator                             | 46: *****       |
| 47. EXT          | Extension                            | 47: *****       |
| 48. OUTSIDE CALL | Outside Call                         | 48: *****       |
| 49. UNKNOWN NAME | Unknown Name                         | 49: *****       |
| 50. CONFERENCE   | Conference                           | 50: *****       |
| 51. ringing      | Ringin                               | 51: *****       |
| 52. busy         | Busy                                 | 52: *****       |
| 53. busy(I)      | Busy With Intrusion Allowed          | 53: *****       |
| 54. wait         | Wait                                 | 54: *****       |
| 55. (I)          | Intrusion                            | 55: ***         |
| 56. Sta          | Station                              | 56: *****       |
| 57. Trk          | Trunk                                | 57: *****       |
| 58: offered      | QSIG call offered to remote endpoint | 58: *****       |

Screen 5-91. Language Translations — Call-Identifiers form (page 4 of 4)

Page 1 of 1

LANGUAGE TRANSLATIONS

| English      | Translation                          | English       | Translation |
|--------------|--------------------------------------|---------------|-------------|
| 1. SUNDAY    | 1: *****                             | 11. APRIL     | 11: *****   |
| 2. MONDAY    | 2: *****                             | 12. MAY       | 12: *****   |
| 3. TUESDAY   | 3: *****                             | 13. JUNE      | 13: *****   |
| 4. WEDNESDAY | 4: *****                             | 14. JULY      | 14: *****   |
| 5. THURSDAY  | 5: *****                             | 15. AUGUST    | 15: *****   |
| 6. FRIDAY    | 6: *****                             | 16. SEPTEMBER | 16: *****   |
| 7. SATURDAY  | 7: *****                             | 17. OCTOBER   | 17: *****   |
| 8. JANUARY   | 8: *****                             | 18. NOVEMBER  | 18: *****   |
| 9. FEBRUARY  | 9: *****                             | 19. DECEMBER  | 19: *****   |
| 10. MARCH    | 10: *****                            |               |             |
| 20.          | English: SORRY, TIME UNAVAILABLE NOW |               |             |
|              | Translation: *****                   |               |             |

Screen 5-92. Language Translations — Date-Time form (page 1 of 1)

Page 1 of 2

LANGUAGE TRANSLATIONS

|    |  |  |
|----|--|--|
| 1. | English: MESSAGES FOR                            |  |
|    | Translation: *****                               |  |
| 2. | English: WHOSE MESSAGES? (DIAL EXTENSION NUMBER) |  |
|    | Translation: *****                               |  |
| 3. | English: END OF MESSAGES (NEXT TO REPEAT)        |  |
|    | Translation: *****                               |  |
| 4. | English: MESSAGES UNAVAILABLE - TRY LATER        |  |
|    | Translation: *****                               |  |
| 5. | English: MESSAGE RETRIEVAL DENIED                |  |
|    | Translation: *****                               |  |
| 6. | English: MESSAGE RETRIEVAL LOCKED                |  |
|    | Translation: *****                               |  |

Screen 5-93. Language Translations — Leave-Word-Calling form (page 1 of 2)

LANGUAGE TRANSLATIONS

- 7. English: NO MESSAGES  
Translation: \*\*\*\*\*
- 8. English: IN PROGRESS  
Translation: \*\*\*\*\*
- 9. English: DELETED  
Translation: \*\*\*\*\*
- 10. English: GET DIAL TONE, PUSH Cover Msg Retrieval  
Translation: \*\*\*\*\*
- 11. English: Message Center (AUDIX) CALL  
Translation: \*\*\*\*\*
- 12. English: CANNOT BE DELETED - CALL MESSAGE CENTER  
Translation: \*\*\*\*\*

Screen 5-94. Language Translations — Leave-Word-Calling form (page 2 of 2)

LANGUAGE TRANSLATIONS

- 1. English: MALICIOUS CALL TRACE REQUEST  
Translation: \*\*\*\*\*
- 2. English: END OF TRACE INFORMATION  
Translation: \*\*\*\*\*
- 3. English: original call redirected from:  
Translation: \*\*\*\*\*;
- 4. English: voice recorder port:  
Translation: \*\*\*\*\*;
- 5. English: MCT activated by: for:  
Translation: \*\*\*\*\*; \*\*\*\*;

Screen 5-95. Language Translations — Malicious-Call-Trace form (page 1 of 2)

LANGUAGE TRANSLATIONS

- 6. English: party : (EXTENSION)  
Translation: \*\*\*\*\* : \*\*\*\*\*
- 7. English: party : (ISDN SID/CNI)  
Translation: \*\*\*\*\* : \*\*\*\*\*
- 8. English: party : (PORT ID)  
Translation: \*\*\*\*\* : \*\*\*\*\*
- 9. English: party : (ISDN PORT ID)  
Translation: \*\*\*\*\* : \*\*\*\*\*

Screen 5-96. Language Translations — Malicious-Call-Trace form (page 2 of 2)

LANGUAGE TRANSLATIONS

| English           | Translation |
|-------------------|-------------|
| 1. ALL MADE BUSY  | 1: *****    |
| 2. BRIDGED        | 2: *****    |
| 3. DENIED         | 3: *****    |
| 4. INVALID        | 4: *****    |
| 5. NO MEMBER      | 5: *****    |
| 6. OUT OF SERVICE | 6: *****    |
| 7. RESTRICTED     | 7: *****    |
| 8. TERMINATED     | 8: *****    |
| 9. TRUNK SEIZED   | 9: *****    |
| 10. VERIFIED      | 10: *****   |
| 11. CDR OVERLOAD  | 11: *****   |
| 12. ANSWERED BY   | 12: *****   |
| 13. CALL FROM     | 13: *****   |
| 14. Skills        | 14: *****   |

Screen 5-97. Language Translations — Miscellaneous-Features form (page 1 of 6)

5 Basic Forms

Language Translations

| English Term | Meaning of English term        | Translated Term |
|--------------|--------------------------------|-----------------|
| 15. TOLL     | Toll                           | 15: ****        |
| 16. FULL     | Full                           | 16: ****        |
| 17. NONE     | None                           | 17: ****        |
| 18. ORIG     | Origination                    | 18: ****        |
| 19. OTWD     | Outward                        | 19: ****        |
| 20. CALL     | <call> This Number             | 20: ****        |
| 21. INTL     | International                  | 21: ****        |
| 22. Info     | Information                    | 22: *****       |
| 23. p        | Primary                        | 23: *           |
| 24. s        | Secondary                      | 24: *           |
| 25. m        | Mark                           | 25: *           |
| 26. p        | Pause                          | 26: *           |
| 27. s        | Suppress                       | 27: *           |
| 28. w        | Wait For A Specified Time      | 28: *           |
| 29. W        | Wait For Off-Premise Dial Tone | 29: *           |

Screen 5-98. Language Translations — Miscellaneous Features form (page 2 of 6)

LANGUAGE TRANSLATIONS

- 30. English: You have adjunct messages  
Translation: \*\*\*\*\*
- 31. English: Login Violation  
Translation: \*\*\*\*\*
- 32. English: Barrier Code Violation  
Translation: \*\*\*\*\*
- 33. English: Authorization Code Violation  
Translation: \*\*\*\*\*
- 34. English: DIRECTORY - PLEASE ENTER NAME  
Translation: \*\*\*\*\*
- 35. English: DIRECTORY UNAVAILABLE - TRY LATER  
Translation: \*\*\*\*\*

Screen 5-99. Language Translations — Miscellaneous-Features form (page 3 of 6)

LANGUAGE TRANSLATIONS

- 36. English: NO MATCH - TRY AGAIN  
Translation: \*\*\*\*\*
- 37. English: NO NUMBER STORED  
Translation: \*\*\*\*\*
- 38. English: TRY AGAIN  
Translation: \*\*\*\*\*
- 39. English: Ext                    in EMRG Q  
Translation: \*\*\*                    \*\*\*\*\*
- 40. English:                    HUNT GROUP        NOT ADMINISTERED  
Translation: \*\*\*\*\*                    \*\*\*\*\*
- 41. English: Q-time                calls  
Translation: \*\*\*\*\*                    \*\*\*\*\*

Screen 5-100. Language Translations — Miscellaneous-Features form (page 4 of 6)

LANGUAGE TRANSLATIONS

- 42. English: Add Skill: Enter number, then # sign  
Translation: \*\*\*\*\*
- 43. English: Remove Skill: Enter number, then # sign  
Translation: \*\*\*\*\*
- 44. English: Enter Skill Level, then # sign  
Translation: \*\*\*\*\*
- 45. English: Enter Agent LoginID  
Translation: \*\*\*\*\*
- 46. English: Call Type  
Translation: \*\*\*\*\*
- 47. English: Call Charge  
Translation: \*\*\*\*\*

Screen 5-101. Language Translations — Miscellaneous-Features form (page 5 of 6)

LANGUAGE TRANSLATIONS

- 48. English: Station Security Code Violation  
Translation: \*\*\*\*\*
  
- 49. English: ENTER REASON CODE  
Translation: \*\*\*\*\*

Screen 5-102. Language Translations — Miscellaneous-Features form (page 6 of 6)

LANGUAGE TRANSLATIONS

- 1. English: CHECK IN - Ext:  
Translation: \*\*\*\*\*
  
- 2. English: CHECK IN: ROOM ALREADY OCCUPIED  
Translation: \*\*\*\*\*
  
- 3. English: CHECK IN COMPLETE  
Translation: \*\*\*\*\*
  
- 4. English: CHECK IN FAILED  
Translation: \*\*\*\*\*

Screen 5-103. Language Translations — Property-Management form (page 1 of 5)

LANGUAGE TRANSLATIONS

- 5. English: CHECK OUT - Ext:  
Translation: \*\*\*\*\*
- 6. English: CHECK OUT: ROOM ALREADY VACANT  
Translation: \*\*\*\*\*
- 7. English: CHECK OUT FAILED  
Translation: \*\*\*\*\*
- 8. English: MESSAGE NOTIFICATION FAILED  
Translation: \*\*\*\*\*
- 9. English: MESSAGE NOTIFICATION ON - Ext:  
Translation: \*\*\*\*\*
- 10. English: MESSAGE NOTIFICATION OFF - Ext:  
Translation: \*\*\*\*\*

Screen 5-104. Language Translations — Property-Management form (page 2 of 5)

LANGUAGE TRANSLATIONS

- 11. English: CHECK OUT COMPLETE: MESSAGE LAMP OFF  
Translation: \*\*\*\*\*
- 12. English: CHECK OUT COMPLETE: MESSAGE LAMP ON  
Translation: \*\*\*\*\*
- 13. English: MESSAGE LAMP ON  
Translation: \*\*\*\*\*
- 14. English: MESSAGE LAMP OFF  
Translation: \*\*\*\*\*

Screen 5-105. Language Translations — Property-Management form (page 3 of 5)



Page 4 of 5

LANGUAGE TRANSLATIONS

15. English: Occupied Rooms  
Translation: \*\*\*\*\*

16. English: Enter Room Status  
Translation: \*\*\*\*\*

17. English: Invalid Maid State  
Translation: \*\*\*\*\*

**Screen 5-106. Language Translations — Property-Management form (page 4 of 5)**

Page 5 of 5

LANGUAGE TRANSLATIONS

18. English: WAKEUP MESSAGE:  
Translation: \*\*\*\*\*

19. English: INVALID NUMBER - TRY AGAIN  
Translation: \*\*\*\*\*

**Screen 5-107. Language Translations — Property-Management form (page 5 of 5)**



**NOTE:**

In order to provide unique labeling for AD button types as shown in [Screen 5-108](#), the switch will replace the last two characters with digits for the 12-key 8400 and 15-key 8434D voice terminals.

The digits following the “AD” are derived from the button position. If the first button is an AD button, then it is AD1 and the fifteenth button is AD15. All the AD buttons between 1 and 15 have the position number appended to “AD.”

5 Basic Forms

Language Translations

change display-messages softkey-labels Page 1 of 1

LANGUAGE TRANSLATIONS

| English   | Translation | English   | Translation | English   | Translation |
|-----------|-------------|-----------|-------------|-----------|-------------|
| 1. AD     | 1. *****    | 17. LWC   | 17. *****   | 33. Acct  | 33. *****   |
| 2. AutCB  | 2. *****    | 18. Mark  | 18. *****   | 34. Drop  | 34. *****   |
| 3. CFrwd  | 3. *****    | 19. Pause | 19. *****   | 35. GrpPg | 35. *****   |
| 4. CnLWC  | 4. *****    | 20. PCall | 20. *****   | 36. WspPg | 36. *****   |
| 5. Cnslt  | 5. *****    | 21. Prog  | 21. *****   | 37. WspAn | 37. *****   |
| 6. Count  | 6. *****    | 22. RngOf | 22. *****   |           |             |
| 7. CPark  | 7. *****    | 23. SAC   | 23. *****   |           |             |
| 8. CPkUp  | 8. *****    | 24. SFunc | 24. *****   |           |             |
| 9. Dir    | 9. *****    | 25. Spres | 25. *****   |           |             |
| 10. DPKUp | 10. *****   | 26. Stats | 26. *****   |           |             |
| 11. Excl  | 11. *****   | 27. Stop  | 27. *****   |           |             |
| 12. HFans | 12. *****   | 28. Timer | 28. *****   |           |             |
| 13. IAuto | 13. *****   | 29. TmDay | 29. *****   |           |             |
| 14. IDial | 14. *****   | 30. View  | 30. *****   |           |             |
| 15. Inspt | 15. *****   | 31. Wait  | 31. *****   |           |             |
| 16. Last  | 16. *****   | 32. Admin | 32. *****   |           |             |

Screen 5-108. Language Translations — Softkey-Labels form (page 1 of 1)

Page 1 of 1

LANGUAGE TRANSLATIONS

1. English: ENTER ACTIVATION ROUTE PLAN, DAY & TIME  
 Translation: \*\*\*\*\*
2. English: ENTER DEACTIVATION DAY AND TIME  
 Translation: \*\*\*\*\*
3. English: OLD ROUTE PLAN: ENTER NEW PLAN:  
 Translation: \*\*\*\*\*: \*\*\*\*\*:
4. English: OLD ROUTE PLAN: NEW PLAN:  
 Translation: \*\*\*\*\*: \*\*\*\*\*:
5. English: ROUTE PLAN: FOR ACT-TIME:  
 Translation: \*\*\*\*\*: \*\*\*\* \*\*\*\*\*:
6. English: ROUTE PLAN: FOR DEACT-TIME:  
 Translation: \*\*\*\*\*: \*\*\*\* \*\*\*\*\*:

Screen 5-109. Language Translations — Time-Of-Day-Routing form (page 1 of 1)

## Listed Directory Numbers

Allows Direct Inward Dialing (DID) numbers to be treated as public Listed Directory Numbers (LDNs). When one of these numbers is direct inward dialed, the calling party is routed to the attendant. The attendant display indicates a Listed Directory Number call and the name associated with the dialed extension.

### Administration commands

Use the following commands to administer the Listed Directory Numbers form.

| Action  | Object                   | Qualifier <sup>1</sup>  |
|---------|--------------------------|-------------------------|
| change  | listed-directory-numbers | —                       |
| display | listed-directory-numbers | ['print' or 'schedule'] |

1. Brackets [ ] indicate the qualifier is optional. Single quotes ( ' ' ) indicate the text inside the quote must be entered exactly as shown or an abbreviated form of the word can be entered.

### Form instructions

```

                                                                 Page 1 of 2
                LISTED DIRECTORY NUMBERS

    Ext      Name
1: 51001    27 character station 51001    TN
2:
3:
4:
5:
6:
7:
8:
9:
10:

                Night Destination: 51002
```

```
change listed-directory-numbers                               Page 2 of 2
                    LISTED DIRECTORY NUMBERS

    Ext      Name
11: 51003   27 character station 51003  1
12:
13:
14:
15:
16:
17:
18:
19:
20:
```

**Screen 5-111. Listed Directory Numbers form (page 2 of 2)**

Make assignments as required for the following fields on the form:

- **Ext** — Enter a valid unassigned extension number (1 to 5 digits).
- **Name** — Enter a name used to identify the Listed Directory Number. Up to 27 alphanumeric characters may be used.
- **TN** — Enter the Tenant Partition number. Default is 1.
- **Night Destination** — Enter the valid assigned extension number (may be a night service extension, a recorded announcement extension, a Vector Directory Number, an individual attendant extension, or a hunt group extension) that will receive calls to these listed numbers when the System is in the Night Service mode. Enter 1 to 5 digits.

**Implementation note:**

---

The number of Listed Directory Numbers that can be assigned varies depending on System configuration. See the *DEFINITY Enterprise Communications Server Release 6 System Description Pocket Reference* for maximum values.

## Loudspeaker Paging

---

The Loudspeaker Paging form contains the fields required to assign zone (speaker location) information for Loudspeaker Paging, Loudspeaker Paging — Deluxe, and Code Calling Access.

### Administration commands

---

Use the following commands to administer the Loudspeaker Paging form.

| Action  | Object             | Qualifier <sup>1</sup>  |
|---------|--------------------|-------------------------|
| change  | paging loudspeaker | —                       |
| display | paging loudspeaker | ['print' or 'schedule'] |

- 
1. Brackets [ ] indicate the qualifier is optional. Single quotes ( ' ') indicate the text inside the quote must be entered exactly as shown or an abbreviated form of the word may be entered.

### Form instructions

---

Make assignments as required for the following fields on each page of the form:

### Page 1 of the Loudspeaker Paging form

```

change paging loudspeaker                                Page 1 of 1
                                LOUDSPEAKER PAGING

                                CDR? y
                                Voice Paging Timeout (sec):
                                Code Calling Playing Cycles:

PAGING PORT ASSIGNMENTS
Zone  Port      Voice Paging      Code Calling      Location:
      TAC  COR  TN      TAC  COR  TN
1:           1           1           1      27 character LOUDSPK PAGING
2:           1           1           1      PAGING
3:           1           1           1      PAGING
4:           1           1           1      PAGING
5:           1           1           1      PAGING
6:           1           1           1      PAGING
7:           1           1           1      PAGING
8:           1           1           1      PAGING
9:           1           1           1      PAGING
ALL:        1           1           1
    
```

Screen 5-112. Loudspeaker Paging form (page 1 of 1)

- **CDR** — Enter **y** (default) to indicate if you want CDR data collection on the paging ports.
- **Voice Paging Timeout (sec)** — Enter from **10** to **600** seconds. This is the length of time the user can be connected to the paging equipment. After the time has elapsed, the call is disconnected. Analyze the typical messages you expect to broadcast; time them; then add another 4 to 5 seconds.
- **Code Calling Playing Cycles** — Enter a number from **1** to **3** to indicate the number of times the code calling identification will play. Analyze who your code calling users are and whether they are likely to hear the code chime the first time.
- **Port** — Enter seven characters.

The entry breaks down as follows:

| Characters | Meaning        | Value         |
|------------|----------------|---------------|
| 1-2        | Cabinet Number | 01 through 22 |
|            |                | 01 through 03 |
|            |                | 01 (G3s)      |

| Characters | Meaning        | Value         |
|------------|----------------|---------------|
| 3          | Carrier        | A through E   |
| 4-5        | Slot Number    | 01 through 20 |
| 6-7        | Circuit Number | 01 through 32 |

 **NOTE:**

When using Administration Without Hardware, place an "X" in this field to indicate that there is no hardware associated with this port assignment.

Each assigned paging zone requires a port on a TN763 Auxiliary Line circuit pack.

If a port is not assigned to a zone, then the CDR, Voice Paging Timeout, and Code Calling Playing Cycles will be set to the System default values when the System is administered.

- **Voice Paging — TAC** — Enter a 1- to 4-digit Trunk Access Code (TAC) that corresponds with the Dial Plan Record. One TAC must be assigned for each zone. This is the code you will dial to access the zone (the physical location of the loudspeakers). The TAC for the field labeled ALL activates all speakers in the nine zones when that access code is dialed. These codes can be assigned to Abbreviated Dialing feature buttons on user stations or to the DTGS buttons on the attendant consoles for easy activation by attendants. A different TAC must be assigned for each paging zone.
- **Voice Paging — COR** — Enter the desired number from **0** through **95**. Each TAC must be assigned a class of restriction (COR) that reflects the desired restriction for Loudspeaker Paging.
- **Voice Paging — TN** — Enter the Tenant Partition number. Default is **1**.
- **Code Calling — TAC** — Enter a 1- to 4-digit TAC that corresponds with the Dial Plan Record. These codes can be assigned to Abbreviated Dialing feature buttons on user stations or to the DTGS buttons on the attendant console for direct access to the zone by the attendant. A different TAC must be assigned for each paging zone.
- **Code Calling — COR** — Enter the desired number from **0** through **95**. Each TAC must be assigned a class of restriction (COR) that reflects the desired restriction for Code Calling.
- **Code Calling — TN** — Enter the Tenant Partition number. Default is **1**.
- **Location** — Enter the location where the loudspeakers are installed (such as conference room A, warehouse, storeroom). Default is PAGING.

## Maintenance-Related System Parameters

---

This form establishes parameters associated with system maintenance.

### Administration commands

---

Use the following commands to administer this form. In some cases, just the most commonly used commands are shown. See [Appendix B, "Administration Commands"](#), for a complete listing of all administration commands, the command structure, and the use of abbreviated command words when entering a command.

| Action  | Object                        | Qualifier <sup>1</sup>  |
|---------|-------------------------------|-------------------------|
| change  | system-parameters maintenance | —                       |
| display | system-parameters maintenance | ['print' or 'schedule'] |

1. Brackets [ ] indicate the qualifier is optional. Single quotes ( ' ' ) indicate the text inside the quote must be entered exactly as shown or an abbreviated form of the word can be entered.

### Form instructions

---

Use this form to specify and display scheduled maintenance operations and maintenance support functions. This form can also be used to activate and deactivate INADS alarm origination when performing repairs.

The following pages describe the fields on this form. For more information on any of the maintenance parameters, see the Maintenance manual for your DEFINITY ECS.



Page 1 of the form

```

Page 1 of X
MAINTENANCE-RELATED SYSTEM PARAMETERS

OPERATIONS SUPPORT PARAMETERS
  Product Identification: 1000000000
  First OSS Telephone Number: 5551212      Abbrev Alarm Report? y
  Second OSS Telephone Number: 5551213     Abbrev Alarm Report? n
  Alarm Origination to OSS Numbers: both
  Cleared Alarm Notification? y
  Restart Notification? y
  Test Remote Access Port? n
  CPE Alarm Activation Level: none
  Packet Bus Activated? y
  Customer Access to INADS Port? n
  Repeat Dial Interval (mins): 7

SCHEDULED MAINTENANCE
  Start Time: 22: 00      Stop Time: 04: 00
  Daily Maintenance: daily      Save Translation: daily
  Control Channel Interchange: no      System Clocks Interchange: no
  SPE Interchange: no

```

Screen 5-113. Maintenance-Related System Parameters form (page 1 of 2)

Operations Support Parameters

- **Product Identification** — A 10-digit number starting with 1 that identifies the switch to an Operations Support System (OSS), for example, INADS.
- **First OSS Telephone Number** — The first telephone number the switch uses to report alarms to, for example, INADS or Trouble Tracker. The number must be obtained from the National Customer Support Center (NCSC) or the TSC. # and \* are not allowed in the telephone number.
- **Abbrev Alarm Report** — Enables the Abbreviated Alarm Report feature for the first OSS. Default is **y**.
- **Second OSS Telephone Number** — The second telephone number that the switch uses to report alarms to, for example, INADS or Definity SNMP. The number must be obtained from the National Customer Support Center (NCSC) or the TSC. # and \* are not allowed in the telephone number.
- **Abbrev Alarm Report** — Enables the Abbreviated Alarm Report feature for the second OSS. Default is **n**.

- **Alarm Origination to OSS Numbers** — Indicates one of four options for alarm origination. If this field is set to anything other than **neither** (default), the craft login has a 30-minute inactivity timeout.
  - If **both**, all Major and Minor alarms result in an automatic call to both OSS telephone numbers. Both OSS telephone numbers must be administered.
  - If **first-only**, all Major and Minor alarms result in an automatic call to the first OSS number only. The switch does not call the second OSS telephone number even if the number is administered. The first OSS telephone number must be administered.
  - If **neither**, alarm origination does not take place. Warning alarms are not reported to either numbers.
  - If **second-as-backup**, all Major and Minor alarms result in an automatic call to the first OSS telephone number. If calling the first OSS telephone number fails four attempts, the switch starts to call the second OSS telephone number as a backup until calling the first OSS telephone number becomes successful. Both OSS telephone numbers must be administered.
- **Cleared Alarm Notification** — Enables the switch to originate a call to the OSS and send an alarm resolution message whenever all previously reported Major and Minor alarms are resolved. Alarm Origination must be activated in order for Cleared Alarm Notification to work. Default is **n**.
- **Restart Notification** — Enables the switch to originate a call to the OSS and report any system restarts caused by problems with the switch.
- **Test Remote Access Port** — Specifies whether testing of the remote access port on the SYSAM circuit pack is enabled. This field should be set to **y** whenever there is an INADS line connected to the switch and there is a maintenance contract in effect so that alarm origination capability is maintained.

If no equipment is connected to the remote access port, or if a trunk for remote access and alarm origination is not provided, running tests on the remote access port on the SYSAM results in test failures. This causes unnecessary maintenance alarms and allows potentially destructive tests to be run. Setting this field to **n** (default) prevents this.
- **CPE Alarm Activation Level** — Indicates the minimum level (Major, Minor or Warning) at which the Customer-Provided Equipment (CPE) alarm is activated. If the level is **none**, **1**.

The CPE does is not activated for any alarm. Default is **none**.

 **NOTE:**

The CPE alarm is always activated when the switch goes into Emergency Transfer, regardless of the CPE Alarm Activation Level setting.

- **Packet Bus Activated** — This field appears only for R5vs/si and later configurations. This field must be **y** for ISDN over PACCON to work.
- **Customer Access to INADS Port** — Provides the capability to prohibit access to system administration and maintenance interface, via the INADS port when using customer login ID's. This field can only be activated by Lucent Technologies services through system-parameters maintenance administration. Default is **n**.

## Scheduled Maintenance

A series of maintenance tests and operations runs automatically every day according to the schedule and settings specified in the following fields:

- **Start Time** — The hour and minute in 24-hour notation at which daily scheduled maintenance will begin running. Default is **22:00**.
- **Stop Time** — The hour and minute when scheduled daily maintenance will stop running. If any daily maintenance operations are not completed by this time, the system will note where in the sequence it stopped and perform those operations during the next scheduled daily maintenance.
- **Daily Maintenance** — This display-only field simply represents the series of tests that are always run by maintenance software as part of daily maintenance.
- **Save Translation** — Indicates on which days translation data in memory will be saved automatically to the Mass Storage System disk and/or tape devices during scheduled maintenance. The save operation is first made to disk, followed by a disk backup to tape. On systems with duplicated SPEs, translation data is saved on both SPEs. Valid entries are **daily** (default), days of the week, or **n**. **N** specifies that no automatic saves are to be executed.
- **Control Channel Interchange** — Each port network has a pair of TDM busses called A and B, each of which has a set of time slots dedicated to use by the control channel. At any one time, the control channel in each PN is carried on only one of the two busses. This field indicates which days the control channel in each port network will be switched from one of the paired TDM busses to the other. Valid entries are **daily**, days of the week, or **n** (default). **N** specifies that no interchange be executed.
- **System Clocks Interchange** — On High and Critical Reliability systems, this option causes a Tone-Clock interchange in each port network with duplicated Tone-Clock circuit packs. Each port network interchanges into the standby Tone-Clock for 20 seconds and then back to the Tone-Clock that was originally active. This field indicates on which days the interchanges are to take place. Valid entries are **daily**, days of the week, or **n** (default). **N** specifies that interchanges be executed.

5 Basic Forms

Maintenance-Related System Parameters

The system performs a Tone-Clock interchange, making the stand by Tone-Clock active. The newly active Tone-Clock circuit pack is tested and, while active, provides system clocks for the port network in which it resides. The system then interchanges back to the originally active Tone-Clock circuit pack.

- **SPE Interchange** — On systems with duplicated SPEs, this field indicates on which days an SPE interchange will be executed during scheduled maintenance. Valid entries are **daily**, days of the week, or **n** (default). **N** specifies no scheduled interchanges.

Page 2 of the form

Page 2 of X

MAINTENANCE-RELATED SYSTEM PARAMETERS

MINIMUM MAINTENANCE THRESHOLDS ( Before Notification )  
 TTRs: 4 CPTRs: 1 Call Classifier Ports:     
 MMIs: 0 VCs:   

TERMINATING TRUNK TRANSMISSION TEST (Extension)  
 Test Type 100: Test Type 102: Test Type 105:

ISDN MAINTENANCE  
 ISDN-PRI TEST CALL Extension:        ISDN BRI Service SPID:       

DS1 MAINTENANCE  
 DSO Loop-Around Test Call Extension:       

LOSS PLAN (Leave Blank if no Extra Loss is Required)  
 Minimum Number of Parties in a Conference Before Adding Extra Loss:       

SPE OPTIONAL BOARDS  
 Disk? y Packet Intf1? y Packet Intf2? n Packet Intf3? n

Screen 5-114. Maintenance-Related System Parameters form (page 2 of 2)

- **TTRs** — When the number of touch tone receivers (TTRs) in service falls below this number (4 to 200), a WARNING alarm is raised against TTR-LEV. These are also known as dual-tone multifrequency receivers (DTMRs). There are 4 TTRs on each TN748 Tone Detector circuit pack, and up to 50 TN748s in a system. To alarm the first occurrence of a TTR being taken out of service, set to 4 times the number of TN748s. If this number is set to more than three less than the total number of TTRs, a port network with only one TN748 could lose all of its TTRs before this alarm is raised.
- **CPTRs** — When the number of call progress tone receivers in service falls below this number (2 to 100), a WARNING alarm is raised against TTR-LEV. These are also known as general purpose tone detectors (GPTDs). There are 2 CPTRs on each TN748 Tone Detector circuit pack,

and up to 50 TN748s in a system. To alarm the first occurrence of a CPTR being taken out of service, set to 2 times the number of TN748s. If this number is set to more than one less than the total number of TTRs, a port network with only one TN748 could lose all of its CPTRs before this alarm is raised.

- **Call Classifier Ports** — When the number of call classifier ports (CLSFY-PTs) in service falls below this number, a WARNING alarm is raised against TTR-LEV. Valid entries are 1 to 200. There are 8 ports on each TN744 Call Classifier circuit pack, and up to 25 TN744s in a system. To alarm the first occurrence of a CLSFY-PT being taken out of service, set this field to 8 times the number of TN744s. If this number is more than 7 less than the total number of CLSFY-PTs in the system, a port network with only one TN744 could lose all of its CLSFY-PTS before the alarm is raised. If there are no TN744s in the system, leave this field blank.
- **MMIs** — The minimum number of ports on Multimedia Interface circuit packs. Only valid if MMCH is enabled. Valid values are **1–128**.
- **VCs** — The minimum number of ports on Voice Conditioner circuit packs. Only valid if MMCH is enabled. Valid values are **1–126**.
- **Test Type 100, Test Type 102, Test Type 105** — An extension assigned to receive tie-trunk calls from other switches with test line origination capability. The system responds by sending a sequence of test tones.
  - Test Type 100 tests far end to near end loss and C-message.
  - Test Type 102 tests far end to near end loss.
  - Test Type 105 tests 2-way loss, gain slope, and C-message and C-notch noise.
- **ISDN-PRI Test Call Extension** — The extension used by a far-end ISDN node to place a call to the system to test the ISDN-PRI trunks between the far-end and the system.
- **ISDN-BRI Service SPID** — Shows whether the link is associated with the Service SPID. If the link is associated with the Service SPID, the field contains a number from **0** to **99999**. This number is the test SPID — otherwise, this field is blank. Service SPID is a feature used by the system technician to check building wiring between the switch and the BRI endpoint.
- **DSO Loop-Around Test Call Extension** — The extension used by the network service provider to set up a DSO loop around connection for testing non ISDN DS1 trunks.

This feature is used primarily for testing DSO channels associated with non ISDN-PRI trunks. The loop-around is activated by dialing the test extension number. Multiple DSO Loop-Around connections can be set up by placing multiple calls to the loop-around extension.

For more information see the information about Facility Test Calls in the maintenance manual for your system.

- **Loss Plan** — Use only when extra loss is required to maintain quality of transmission on conference calls. Leave this field blank if no extra loss is required. If extra loss is required, enter digits as shown below.

| No. Of Parties To Be Conferenced | Enter Digit |
|----------------------------------|-------------|
| 3                                | 2           |
| 4                                | 3           |
| 5                                | 4           |
| 6                                | 5           |
| 7                                | 6           |

- **SPE Optional Boards** — These fields indicate whether a Disk circuit pack is present in the system, and which Packet Interface slots are administered. If a Packet Interface circuit pack is physically present, the corresponding `Packet Interface` field is set to **y** when the system boots, and no change to that field is allowed. If the system is equipped with duplicated SPEs, a `Packet Interface` field is set to **y** when either SPE carrier contains a Packet Interface circuit pack in the corresponding position. If a Packet Interface circuit pack is not present, then the value for the `Packet Interface` field is read from translation data stored on disk or tape. If the field is **n**, a Packet Interface circuit pack may be administered by changing the corresponding `Packet Interface` field to **y**.

Page 3 of the form (vs/si/csi only)

```
change system-parameters maintenance           Page 3 of 3

      MAINTENANCE-RELATED SYSTEM PARAMETERS

Modem Connection: none
      Data Bits: 8
      Parity: None

external      none
```

Screen 5-115. Maintenance-Related System Parameters form (page 3 of 3)

- **Modem Connection** — Indicates the type of modem connection. Values for vs/si are **internal**, **external** or **none**. Values for csi are **external** or **none**. This value cannot be “**none**” if Alarm Origination to OSS Numbers is enabled.
- **Data Bits** — The number of data bits, either **7** or **8**.
- **Parity** — A display only field. Value is none.

## Mode Code Related System Parameters

---

This form establishes parameters associated with the Mode Code Voice Mail System Interface.

### Administration commands

---

Use the following commands to administer the Mode Code Related System Parameters form. In some cases, just the most commonly used commands are shown. See [Appendix B, "Administration Commands"](#) for a complete listing of all administration commands, the command structure, and the use of abbreviated command words when entering a command.

| Action  | Object                      | Qualifier <sup>1</sup> |
|---------|-----------------------------|------------------------|
| change  | system-parameters mode-code | —                      |
| display | system-parameters mode-code | ['print' ]             |

1. Brackets [ ] indicate the qualifier is optional. Single quotes ( ' ) indicate the text inside the quote must be entered exactly as shown or an abbreviated form of the word can be entered.

### Form instructions

---

Use the Mode Code Related System Parameters form to specify and display mode codes and administer the duration and interval of touch tones sent from the switch to the voice mail system (VMS). Mode codes are the touch tones that the switch sends to the VMS to indicate the type of call (for example, internal caller, external caller, call coming from coverage) that is accessing the voice mail system.

The following pages describe the fields on the Mode Code Related System Parameters form.

#### NOTE:

You should first check `Mode Code Interface` on the System Parameters Customer Options form. This field must be set to `y`.



## Page 1 of the form

```

                                                                 Page 1
                MODE CODE RELATED SYSTEM PARAMETERS

MODE CODES (FROM SWITCH TO VMS)
  Direct Inside Access: #00__
Direct Dial Access - Trunk: #01__
  Internal Coverage: #02__
  External Coverage: #03__

System In Day Service: #11
System In Night Service: #12

                OTHER RELATED PARAMETERS
DTMF Duration On (msec): 100 Off (msec): 100 Sending Delay (msec): 100

VMS Hunt Group Extension : _____
```

### Screen 5-116. Mode Code Related System Parameters form

#### Mode Code Parameters

- **Direct Inside Access** — This is a value of up to six digits that may include #, \*, or 0 to 9. A blank field is valid and the default is #00. This value defines a mode code that the switch sends when a caller at an internal extension dials the VMS access number.
- **Direct Dial Access - Trunk** — This is a value of up to six digits that may include #, \*, or 0 to 9. A blank field is valid and the default is #01. This value defines a mode code that the switch sends when an external caller dials the VMS access number.
- **Internal Coverage** — This is a value of up to six digits that may include #, \*, or 0 to 9. A blank field is valid and the default is #02. This value defines a mode code that the switch sends when an internal caller tries to reach a user at another extension and the call goes to the user's voice mail coverage.
- **External Coverage** — This is a value of up to six digits that may include #, \*, or 0 to 9. A blank field is valid and the default is #03. This value defines a mode code that the switch sends when an external caller tries to reach a user at another extension and the call goes to the user's voice mail coverage.

## 5 Basic Forms

### *Mode Code Related System Parameters*

Page 5-222

- **System In Day Service** — This is a value of up to six digits that may include #, \*, or 0 to 9. A blank field is allowed and the default is #11. This value indicates to the VMS that the DEFINITY ECS has changed from Night to Day Service.
- **System In Night Service** — This is a value of up to six digits that may include #, \*, or 0 to 9. A blank field is allowed and the default is #12. This value indicates to the VMS that the DEFINITY ECS has changed from Day to Night Service.

### Other Related Parameters

- **DTMF DURATION ON** — This value must be a multiple of 25 and can be between 75 and 500 milliseconds. This field cannot be blank. Default is 100 milliseconds. This value defines the length, in milliseconds, of mode code digits sent to the VMS.
- **OFF** — This value must be a multiple of 25 and can be between 75 and 200 milliseconds. This field cannot be blank. Default is 100 milliseconds. This value defines the interdigit interval, or pause, between mode code digits as they are sent to the VMS.
- **Sending Delay** — This value must be a multiple of 25 and can be between 75 and 1000 milliseconds. This field cannot be blank. Default is 100 milliseconds. This value defines the delay between the time the switch receives answer supervision from the VMS and the time the first mode code digit is sent.
- **VMS Hunt Group Extension** — This field should contain the extension of a hunt group containing VMI extensions. A check is made to verify that a valid hunt group extension is entered, but a check is not made to verify that the hunt group members are VMI extensions. A blank field is allowed or the field can be administered to any assigned hunt group extension within the switch.

## Modem Pool Group

---

There are two types of conversion resources for Modem Pooling. The first type, an *integrated conversion resource*, is a circuit pack that emulates a Trunk Data Module connected to a 212A-type modem. Two conversion resources are on each circuit pack.

The second type, a *combined conversion resource*, is a separate Trunk Data Module and modem administered as a unit. The Trunk Data Module component of the conversion resource may be either a Modular Trunk Data Module (MTDM) or 7400A Data Module and connects to a digital port using Digital Communications Protocol (DCP); the modem connects to an analog port.

### Administration commands

---

Use the following commands to administer the Modem Pool Group form.

| Action  | Object         | Qualifier <sup>1</sup>          |
|---------|----------------|---------------------------------|
| add     | modem-pool num | [1-MAX]                         |
| change  | modem-pool num | [1-MAX]                         |
| display | modem-pool num | [1-MAX] ['print' or 'schedule'] |
| list    | modem-pool num | ['print' or 'remove']           |
| remove  | modem-pool num | [1-MAX]                         |

- 
1. Brackets [ ] indicate the qualifier is optional. Single quotes ( ' ' ) indicate the text inside the quote must be entered exactly as shown or an abbreviated form of the word may be entered. MAX is the maximum number available in your system configuration.

### Form instructions

---

```

                                                                 Page 1 of 1
                                MODEM POOL GROUP
Group Number: 1                      Group Type: integrated
Receiver Responds to Remote Loop? n      Hold Time (min): 5
Send Space Disconnect? y                Receive Space Disconnect? y
CF-CB Common? y                        Loss of Carrier Disconnect? y
Speed: LOW/300/1200      Duplex: full      Synchronization: a/sync
CIRCUIT PAIR ASSIGNMENTS
                                Circuit Pack  Circuit Pack
                                Location      Location
1:  ___      9:  ___
2:  ___     10: ___
3:  ___     11: ___
4:  ___     12: ___
5:  ___     13: ___
6:  ___     14: ___
7:  ___     15: ___
8:  ___     16: ___
```

Screen 5-117. Modem Pool Group — Integrated form (page 1 of 1)

### Implementation note

---

Page 1 when Group Type is **integrated**.

```

                                                                 Page 1 of 1
                                MODEM POOL GROUP
Group Number: _                      Group Type: combined
Modem Name: _____                Hold Time (min): 5_
Time Delay: 0_____                 Direction: two-way
Speed: LOW/300/1200___      Duplex: full      Synchronization: async
PORT PAIR ASSIGNMENTS
Analog Digital    Analog Digital    Analog Digital    Analog Digital
1:  ___  ___      9:  ___  ___      17: ___  ___      25: ___  ___
2:  ___  ___     10: ___  ___      18: ___  ___      26: ___  ___
3:  ___  ___     11: ___  ___      19: ___  ___      27: ___  ___
4:  ___  ___     12: ___  ___      20: ___  ___      28: ___  ___
5:  ___  ___     13: ___  ___      21: ___  ___      29: ___  ___
6:  ___  ___     14: ___  ___      22: ___  ___      30: ___  ___
7:  ___  ___     15: ___  ___      23: ___  ___      31: ___  ___
8:  ___  ___     16: ___  ___      24: ___  ___      32: ___  ___
```

Screen 5-118. Modem Pool Group — Combined form (page 1 of 1)

## Implementation note

---

Page 1 when `Group Type` is **combined**.

Make assignments as required for the following fields on the form:

- **Group Number** — Enter a group number when completing a paper form. This is a display-only field when the form is accessed using an administration command such as **add** or **change**.
- **Group Type** — Enter **integrated** or **combined**.
- **Receiver Responds to Remote Loop** — Enter **y** to allow far-end modem to put conversion resource into loop back mode. Default is **n**. (This field displays only when `Group Type` is **integrated**.)
- **Hold Time (min)** — Enter the maximum number of minutes (**1** through **99**) that a conversion resource in the group may be held while a call waits in a queue or reserved after Data Call Preindication. Default is **5**.
- **Send Space Disconnect** — Enter **y** (default) to allow the conversion resource to send 4 seconds of space before disconnecting. (This field displays only when `Group Type` is **integrated**.)
- **Receive Space Disconnect** — Enter **y** (default) to allow the conversion resource to disconnect after receiving 1.6 seconds of space. (This field displays only when `Group Type` is **integrated**.)
- **CF-CB Common** — Enter **y** (default) to indicate that the CF and CB leads on the conversion resource are logically connected. (This field displays only when `Group Type` is **integrated**.)
- **Loss of Carrier Disconnect** — Enter **y** (default) to permit conversion resource to disconnect if it detects a dropped carrier. (This field displays only when `Group Type` is **integrated**.)
- **Modem Name** — Enter a 1- to 6-alphanumeric character string to indicate the name of the modem pool. (This field displays only when `Group Type` is **combined**.)
- **Time Delay** — Enter the time delay in seconds (**0** through **255**) to insert between sending the ringing to the modem and the off-hook alert to the data module. Default is **0**. (This field displays only when `Group Type` is **combined**.)
- **Direction** — Enter the direction (**incoming**, **outgoing** or **two-way**) of the call for which modem pool will operate. Default is **two-way**. (This field displays only when `Group Type` is **combined**.)

The following fields (`Speed`, `Duplex`, and `Synchronization`) cannot be filled out for the "integrated" pooled modem forms but can be assigned on the "combined" pooled modem form. The integrated conversion resource will automatically adjust its speed and synchronization to the endpoint it is connected to. In synchronous mode, the integrated modem pool can operate at

1200 baud. In asynchronous mode, it can operate at 300 or 1200 baud. Full-duplex operation is always used.

- **Speed** — Enter the communication speed in bits per second (LOW — 0 to 300 blind sampled, **300, 1200, 2400, 4800, 9600, or 19200**) of the conversion resources in the group. Enter one to three speeds separated by slashes (for example, 300/1200/2400) to indicate a maximum of three running speeds. Default is **LOW/300/1200**.
- **Duplex** — Enter **full** (default) or **half** to indicate the duplex mode of the conversion resources in the group.
- **Synchronization** — Enter **sync** or **async** (default) to indicate the synchronization mode of the conversion resources in the group.

**CIRCUIT PACK ASSIGNMENTS** are optional on "integrated" conversion resource forms only.

- **Circuit Pack Location** — Enter the port associated with the conversion resource on the integrated modem pool circuit pack. Enter seven characters.

The entry breaks down as follows:

| Characters | Meaning        | Value         |
|------------|----------------|---------------|
| 1-2        | Cabinet Number | 01 through 22 |
|            |                | 01 through 03 |
|            |                | 01 (G3s)      |
| 3          | Carrier        | A through E   |
| 4-5        | Slot Number    | 01 through 20 |
| 6-7        | Circuit Number | 01 through 32 |

**PORT PAIR ASSIGNMENTS** are optional on "combined" pooled modem forms only.

- **Analog Digital** — Enter the port numbers of the modem/TDM pair in a conversion resource. Enter seven characters.

The entry breaks down as follows:

| Characters | Meaning        | Value         |
|------------|----------------|---------------|
| 1-2        | Cabinet Number | 01 through 22 |
|            |                | 01 through 03 |
|            |                | 01 (G3s)      |

| <b>Characters</b> | <b>Meaning</b> | <b>Value</b>  |
|-------------------|----------------|---------------|
| 3                 | Carrier        | A through E   |
| 4-5               | Slot Number    | 01 through 20 |
| 6-7               | Circuit Number | 01 through 32 |

 **NOTE:**  
Two port entries are required.

## Multifrequency-Signaling-Related System Parameters

This form sets the system parameters associated with multifrequency signaling.

### Administration commands

Use the following commands to administer the Multifrequency-Signaling-Related System Parameters form.

| Action  | Object                                     | Qualifier <sup>1</sup>  |
|---------|--|-------------------------|
| change  | system-parameters multifrequency-signaling |                         |
| display | system-parameters multifrequency-signaling | ['print' or 'schedule'] |

1. Brackets [ ] indicate the qualifier is optional. Single quotes ( ' ) indicate the text inside the quote must be entered exactly as shown or an abbreviated form of the word may be entered.

### Form instructions

#### Page 1 of the form

```

                                                                Page 1 of 2
MULTIFREQUENCY-SIGNALING-RELATED SYSTEM PARAMETERS

Incoming Call Type: group-ii-mfc
Outgoing Call Type: none
Maintenance Call Type: none           NEXT ANI DIGIT
Test Call Extension:                   Incoming: send-ani
Interdigit Timer (sec): 10
Maximum Resend Requests: _

Received Signal Gain (dB): 0
Transmitted Signal Gain (dB): -3
Request Incoming ANI (non-AAR/ARS)? n

Multifrequency Signaling Incoming Intercept Treatment? n

Overlap Sending on Link-to-Link Tandem Calls? n
Private Group II Permissions and Public Interworking? y
```



## Implementation

[Screen 5-119](#) appears when Incoming Call Type is **group-ii-mfc** and Outgoing Call Type is **none**.

Page 1 of 4

### MULTIFREQUENCY-SIGNALING-RELATED SYSTEM PARAMETERS

```
Incoming Call Type: group-ii-mfc           ANI Prefix:
Outgoing Call Type: group-ii-mfc         ANI for PBX:
Maintenance Call Type: none             NEXT ANI DIGIT
Test Call Extension:                    Incoming: send-ani
Interdigit Timer (sec): 10              Outgoing: send-ani
Maximum Resend Requests: _

Received Signal Gain (dB): 0
Transmitted Signal Gain (dB): -3
Request Incoming ANI (non-AAR/ARS)? n
Outgoing Forward Signal Present Timer (sec): 15
Outgoing Forward Signal Absent Timer (sec): 30
Multifrequency Signaling Incoming Intercept Treatment? n
Collect All Digits Before Seizure? n
Overlap Sending on Link-to-Link Tandem Calls? n
Private Group II Permissions and Public Interworking? y
Convert First Digit End-of-ANI To: _

Group II Called Party Category: user-type
Use COR for Calling Party Category? n
```

Screen 5-120. Multifrequency-Signaling-Related System Parameters form (page 1 of 4)

## Implementation notes

[Screen 5-120](#) appears when both Incoming Call Type and Outgoing Call Type are **group-ii-mfc**.

The ANI Prefix, ANI for PBX, and Collect All Digits Before Seizure fields appear only when the value of the Outgoing Call Type field is **group-ii-mfc** or **mfe**.

If Collect All Digits Before Seizure is **y**, Overlap Sending on Link-to-Link Tandem Calls and Convert First Digit End-of-ANI are not displayed.

- **Incoming Call Type** — Enter **group-ii-mfc** (default), **non-group-ii-mfc**, or **mfe** (multi-frequency Espanol, used only in Spain). This field defines the signal type that a CO uses to place an incoming call to the PBX.

If the value of this field is **group-ii-mfc**, the second page of the form will display entries for all group-I, group-II, group-A, and group-B signal types with a set of default values (see page 2 of form). If the value is **non-group-ii-mfc**, the second page displays only group-I and group-A signal types.

- **Outgoing Call Type** — Enter **group-ii-mfc**, **none** (default), or **mfe** (multi-frequency Espanol, used only in Spain). This field defines the signal type that the PBX uses to place an outgoing call into a CO.

If the content of this field is **group-ii-mfc**, the system displays the third page of the form. The third page displays entries for all group-I, group-II group-A, and group-B signal types with a set of default values. If the content of this field is **none**, the system does not display the third page. In addition, *Outgoing Forward Signal Present Timer*, *Outgoing Forward Signal Absent Timer*, *ANI Prefix*, *ANI for PBX*, *Next ANI Digits*, and *Collect All Digits Before Seizure* will not display on page 1 of the form.

- **MFE Type** — Enter **2/5** (default) or **2/6** to determine which public signaling the switch will use. The field only appears when *Incoming Call Type* is **mfe** and the *Outgoing Call Type* is **mfe** or **none**.
- **Maintenance Call Type** — Enter **1**, **2**, or **none** (default) to indicate which maintenance test is indicated when the CO sends an MFC maintenance tone. Currently, **1** indicates the Belgium maintenance sequence, and **2** indicates the Saudi Arabian sequence.
- **Test Call Extension** — Enter an unassigned extension to specify the destination of a call between the CO and the PBX that tests R2-MFC signaling. A test call extension is used when the call type is **1**. Default is blank.
- **Interdigit Timer (sec)** — Enter a number between **1** and **255** to specify the maximum number of seconds the switch will wait for the first forward signal (digit) to arrive, and for subsequent expected digits to arrive. Intercept returns to the calling party if this timer expires. Default is **10**.

 **NOTE:**

Make sure the number of seconds entered in this field is less than the number of seconds entered in the short interdigit timer.

- **Maximum Resend Requests** — Enter **1–99** (or blank) to indicate the threshold number of resend type MFC signals DEFINITY ECS will accept during an outgoing call or blank. **1** means the call is dropped if one resend signal is received and blank means there is an unlimited number of resend requests allowed. Default is blank.
- **Outgoing Forward Signal Present Timer (sec)** — Enter a number between **1** and **255** to specify the maximum number of seconds to elapse between signals on a call. This timer runs when MFC tones are being sent or received on an outgoing call. The timer starts (and restarts) timing when

the PBX begins sending a forward signal, and stops timing when the PBX receives the corresponding backward signal. This field displays only when the value of `Outgoing Call Type` is **group-ii-mfc**. Default is **15**.

- **Outgoing Forward Signal Absent Timer (sec)** — Enter a number between **11** and **255** to indicate the maximum number of seconds to elapse between forward signals on outgoing calls. The timer starts (and restarts) when a forward tone is taken off the link and it stops when the next forward tone is applied to the link. This field displays only when the content of `Outgoing Call Type` is **group-ii-mfc**. Default is **30**.
- **Multifrequency Signaling Incoming Intercept Treatment** — Enter **y** (default) or **n** to indicate whether a group B "intercept" message is sent to the CO. If the value of this field is **n**, then the normal DID/TIE/ISDN intercept treatment is applied. If the value is **y**, then the group B signal for the intercept is sent to the CO, and the intercept tone plays on the trunk.
- **Overlap Sending on Link-to-Link Tandem Calls** — Enter **y** or **n** (default) to enable overlap sending on link-to-link tandem calls. If **y**, DEFINITY ECS sends and receives digits one digit at a time instead of enbloc. (With enbloc, digits are not sent until the entire group of digits is received).



**NOTE:**

A DEFINITY ECS with this field set to **y** when tandeming calls between switches will send ANI for PBX to the terminating switch if that switch requests ANI before the DEFINITY ECS receives it from the originating switch. The terminating switch may request ANI before the receipt of the last address digit if it is not a DEFINITY ECS or it is a DEFINITY ECS with the `Request Call Category` at `Start of Call` field set to **y**.

- **Private Group II Permissions and Public Interworking? y/n** — Enter **y** or **n** (default). If **y**, DEFINITY ECS:
  - Sends the Category for MFC ANI for the COR of the originating party for non-private-MFC-trunk to MFC-private-trunk calls
  - Sends the Group II category received over the incoming private trunk as the outgoing Group II category on tandem private MFC calls
  - Applies MFC group II-CPC termination restrictions on incoming MFC private trunk calls.
  - Checks station permissions if you call forward off-net.
- **Convert First Digit End-of-ANI To** — Enter any digit **0–9** or blank (default) to specify to what the digit an incoming initial end-of-ani or end-of-dial MF signal should be converted. Administer on a per-switch basis.

- **Received Signal Gain (-Loss) (dB)** — Enter a number between **-15** and **3** to specify the loss/gain when the MFC port listens to the trunk port. Default is **0**. Currently listens with a range of -5 to -35; this value moves the range (for example, a value of -5 provides a range of -10 to -40).
- **Transmitted Signal Gain (-Loss) (dB)** — Enter a number between **-15** and **3** to specify the loss/gain when the trunk port listens to the MFC port. Default is **-3**. The MFC port currently generates at -5 for MFC and -8 for MFE; this field adds gain or loss to the starting value of -5.
- **ANI Prefix** — Enter between one and six digits to define the prefix to apply to an extension number when ANI is sent to the CO. This field appears only when *Outgoing Call Type* is **group-ii-mfc** or **mfe**. Default is blank.
- **ANI for PBX** — Enter a number from **2** to **15** to define the PBX identification number that is sent to the CO when ANI is requested (by the CO) on a particular call but is not available, such as tandem tie trunk calls. This field appears only when *Outgoing Call Type* is **group-ii-mfc**. Default is blank.
- **Next ANI Digit** — This field appears when *Outgoing Call Type* is **group-ii-mfc**. Valid input is **next-digit**, **next\_ani\_digit**, and **send-ani** (default). This field determines whether the Next ANI Digit signal will be the same as the "send-ani" signal or the "next-digit" signal or another signal defines as "next\_ani\_digit."
- **Collect All Digits Before Seizure** — Enter **y** or **n** (default) to determine whether the system collects all the digits before seizing the trunk. This field appears only when *Outgoing Call Type* is **group-ii-mfc** or **mfe**.



**NOTE:**

If the following field is **y**, the *ANI Req* field on the AAR and ARS Digit Conversion Table does not apply. To control ANI collection via the ARS forms, set to **n**.

- **Request Incoming ANI (non-AAR/ARS)** — Enter **y** or **n** (default) to determine whether ANI should be requested on incoming R2-MFC calls. This field only applies if the incoming call via the R2-MFC trunk is terminating to a local station on this PBX.



**NOTE:**

The following three fields appear only if *Incoming Call Type* is **mfe** and *Outgoing Call Type* is **mfe** or **none**.

- **Forward Cycle Timer (sec)** — Enter a number from **1** to **255** to determine how many seconds to wait to receive the check frequency after sending an MFE signal. Default is **5**.
- **Backward Cycle Timer (sec)** — Enter a number from **1** to **255** to determine how many seconds to wait to send the check frequency after receiving an MFE signal. Default is **5**.

- **Income Dial Timer (sec)** — Enter a number between **45 - 255** to determine how long to wait from the start of a call until the end of the check frequency of the last signal. Default is **90**.
- **Outgoing Start Timer (sec)** — Enter a number from **1 to 255** to indicate how long to time from seizure until the beginning of the first Group A signal from the receiving end, and from the end of the check frequency until the beginning receipt of the first digit following the Group II signal. The field appears only if Incoming Call Type and Outgoing Call Types are both "mfe".
- **Called Party Category** — Enter "user-type" (default) or "call-type" to determine which type of group II signals should be used on the outgoing R2-MFC call.
- **Use COR for Calling Party Category** — Enter **y** or **n** (default) to indicate what category should be sent with ANI if requested on an outgoing R2-MFC call. If you enter **y**, the category translated for the calling facility's COR is used. If you enter **n**, the category is determined based on the calling party's user-type.

Page 2 of the form

Page 2 of 4

MULTIFREQUENCY-SIGNALING-RELATED SYSTEM PARAMETERS

Request Call Category at Start of Call: n  
 Restart ANI from Caller Category? y  
 Number of Incoming ANI Digits: 0  
 Number of Outgoing ANI Digits: 0\_\_  
 Truncate station number in ANI \_\_\_\_\_

|                    | INCOMING | OUTGOING |
|--------------------|----------|----------|
| ANI Available:     | ___      | ___      |
| ANI Not Available: | ___      | ___      |

Screen 5-121. Multifrequency-Signaling-Related Parameters form (page 2 of 4)

Implementation notes

Previously, the user administered ANI Available and ANI-Not-Available as Group I forward signals in the range of 11-15. Now these signals range from 1 to 15. If ANI Available or ANI-Not-Available is administered in both places, the following error messages should be generated when the user submits the data:

- Error: ANI available signal must be administered only once.

- Error: ANI not available signal must be administered only once.

Either ANI for PBX or ANI-Not-Available signal must be set. If the ANI for PBX field is blank (used for the tandeming cases), then the ANI-Not-Available signal field must be set. If one of these conditions is not set, the following error message generates:

- Error: ANI for PBX or outgoing ANI Not Available signal must be defined.

Currently end-of-ani or end-of-digits must be set. Now, either one of them or Number of Outgoing ANI Digits must be defined or the user receives the following error message:

- End-of-ani, end-of-digits or Number of Outgoing ANI Digits must be defined.

The values for ANI available and ANI-Not-Available must be different or the user receives the following message:

ANI-Available and ANI-Not-Available signal values must be different.

The fields shown on Page 2 define call category and ANI information.

- **Request Call Category at Start of Call**— Enter **y** or **n** (default) to indicate that the Send-ANI backward signal requesting for the caller-category information will be sequenced differently in the MFC signaling flow.

The Caller-category Request backward signal is disjointed from the ANI request. If this field is **y**, the Send-ANI backward signal corresponds exclusively to the caller-category request. In response to this signal, DEFINITY ECS sends a forward signal containing the caller-category information on outgoing calls. On incoming calls, DEFINITY ECS sends the Send-ANI backward signal upon receipt of the first address signal.

- **Restart ANI from Caller Category?** — Enter **y** (default) or **n** to enable DEFINITY ECS to send the caller-category signal later again when the signals for Caller-Category and ANI requests are the same and this signal is received after the Next-Digit forward signals have been received.
- **Number of Incoming ANI Digits** — Enter a number from **0** to **15** to administer the number of ANI digits for incoming MFC calls. Default is **0**.
- **Number of Outgoing ANI Digits** — Enter a number from **0** to **15** to administer the number of ANI digits for outgoing MFC calls. Default is **0**.

DEFINITY ECS appends ANI-Not-Available digits to ANI digits if the actual ANI length is less than the value administered in this field.

**Truncate station number in ANI** — This field defines the side of the extension number to truncate from when station ANI is sent to the CO. *The ANI prefix (either MFC or COR) is not truncated. There is no effect if ANI for PBX is sent.* Valid entries are **beginning**, **ending**, and **no** (default).

- **ANI Available** — Enter a number from **1** to **15** to define the incoming and outgoing ANI-Available signals. Default is blank.
- **ANI Not Available** — Enter a number from **1** to **15** to define the incoming and outgoing ANI-Not-Available signals. Default is blank.

 **NOTE:**

On incoming calls, when the ANI-Not-Available forward signal is received, DEFINITY ECS responds with the End-of-Dial backward signal. If the ANI-Available forward signal is received, the subsequent backward signal to collect the remaining ANI digits is Next ANI.

On outgoing calls, whenever ANI is possible, DEFINITY ECS outputs the ANI-Available forward signal to the CO confirming that ANI is available. Conversely, if ANI is not possible, DEFINITY ECS outputs the ANI-Not-Available forward signal to the CO.

Page 3 of the form

Page 3 of 4

MULTIFREQUENCY-SIGNALING-RELATED SYSTEM PARAMETERS

| INCOMING FORWARD SIGNAL TYPES<br>(Tones from CO) |            | INCOMING BACKWARD SIGNAL TYPES<br>(Tones to CO) |               |
|--|------------|---|---------------|
| Group-I  | Group-II   | Group-A   | Group-B       |
| 11: ignored                                      | 1: normal  | 1: next-digit                                   | 1: free       |
| 12: ignored                                      | 2: normal  | 3: end-of-dial                                  | 2: busy       |
| 13: ignored                                      | 3: normal  | __:   | 4: congestion |
| 14: ignored                                      | 4: normal  | __:   | 7: intercept  |
| 15: ignored                                      | 5: normal  | __:   | __:           |
|  | 6: normal  | __:   | __:           |
|  | 7: normal  | __:   | __:           |
|  | 8: normal  | __:   | __:           |
|  | 9: normal  | __:   | __:           |
|  | 10: normal | __:   | __:           |
|  | 11: normal | __:   | __:           |
|  | 12: normal | __:   | __:           |
|  | 13: normal | __:   | __:           |
|  | 14: normal | __:   | __:           |
|  | 15: normal | __:   | __:           |

**Implementation note**

[Screen 5-122](#) shows the defaults when the Incoming Call Type field is **group-ii-mfc**. A variation of the above appears if Incoming Call Type is equal to **non-group-ii-mfc**. In addition, when Incoming Call Type is **non-group-ii-mfc**, group II and group B columns are not displayed.

The fields shown on Page 3 define the meaning of MFC tones for calls originated at the CO. See [“Definitions of Group I, II, A, and B signals” on page 5-237](#).

When the form initially appears, either of two sets of default values is possible. One set is for the group II call type; the other set is for non-group II call type. In each set, the default value for each field is set to the most common value.

- **Tones from CO on Incoming Forward Calls — Group I** — Message codes 11 to 15 display. (Numbers 1 through 10 are assigned to the digits of the destination telephone number.) Assign a meaning to each code. If Incoming Call Type is **group-ii-mfc**, acceptable meanings are **drop**, **ani-avail**, **end-of-ani**, **end-of-dial**, **ignored**, **maint-call**, **ani-not-avail**, and **send-congest**. If the Incoming Call Type is **non-group-ii-mfc**, acceptable meanings are **drop** and **ignored**.

**Page 4 of the form**

Page 4 of 4

MULTIFREQUENCY-SIGNALING-RELATED SYSTEM PARAMETERS

| OUTGOING FORWARD SIGNAL TYPES<br>(Tones to CO) |              | OUTGOING BACKWARD SIGNAL TYPES<br>(Tones from CO) |                |
|--|--------------|---|----------------|
| Group-I  | Group-II     | Group-A   | Group-B        |
| __: _____                                      | 2: normal    | 1: next-digit                                     | 1: free        |
| __: _____                                      | 5: attendant | 2: congestion                                     | 2: busy        |
| __: _____                                      | 6: data-call | 3: end-of-dial                                    | 3: congestion  |
| __: _____                                      | __: _____    | 4: congestion                                     | 4: congestion  |
| __: _____                                      | __: _____    | 5: call-info-ani                                  | 5: congestion  |
| __: _____                                      | __: _____    | 6: congestion                                     | 6: free        |
| __: _____                                      | __: _____    | 7: last-2-digits                                  | 7: intercept   |
| __: _____                                      | __: _____    | 8: last-3-digits                                  | 8: congestion  |
| __: _____                                      | __: _____    | 9: congestion                                     | 9: congestion  |
| __: _____                                      | __: _____    | 10: congestion                                    | 10: congestion |
| __: _____                                      | __: _____    | 11: congestion                                    | 11: congestion |
| __: _____                                      | __: _____    | 12: congestion                                    | 12: congestion |
| __: _____                                      | __: _____    | 13: congestion                                    | 13: congestion |
| __: _____                                      | __: _____    | 14: congestion                                    | 14: congestion |
| __: _____                                      | __: _____    | 15: congestion                                    | 15: congestion |



This page only appears if *Outgoing Call Type* is **group-ii-mfc** or **mfe**. The fields shown on this page define the meaning of MFC tones for calls originated at the PBX. [See “Definitions of Group I, II, A, and B signals” on page 5-237.](#)

- **Tones to CO on Outgoing Forward Calls — Group I** — Enter numbers between **11** and **15** to identify the message codes. (Numbers 1 through 10 are assigned to the digits of the destination telephone number.) Then assign a meaning to each code. Acceptable meanings are **end-of-digits**, **ani-avail**, **end-of-ani**, and **ani-not-avail**.
- **Tones to CO on Outgoing Forward Calls — Group II** — Enter numbers between **1** and **15** to identify the message codes. Then assign a meaning to each code. Acceptable meanings are **attendant**, **data-call**, **toll-auto**, and **normal**. Each or these can only appear once in the group II column.
- **Tones from CO on Outgoing Backward Calls — Group A** — Message codes between 1 and 15 display. Assign a meaning to each code. Acceptable meanings are **send-ani**, **congestion**, **drop**, **end-of-dial**, **last-2-digits**, **last-3-digits**, **last-digit**, **next-digit**, **restart**, **intercept**, **resend-digit**, and **setup-sppath**.
- **Tones from CO on Outgoing Backward Calls — Group B** — Message codes between 1 and 15 display. Then assign a meaning to each code. Acceptable meanings are **busy**, **congestion**, **free**, **tie-free**, and **intercept**.

## Definitions of Group I, II, A, and B signals

### Group I signals

Group I signals are a basic set of forward signals generated by the originating switch, as follows:

#### **ani-avail**

If this signal is defined and ANI is requested on outgoing R2-MFC calls, ANI is sent to the CO before ANI caller digits are sent. Note that this signal is sent after the ANI caller category signal. It is used in Hungary.

#### **ani-not-avail**

This signal is sent to the CO when the caller's number is not available in response to the ANI request. It is used on DOD calls in Brazil and Columbia.

#### **digits 1 to 10**

The signals from group I.1 to I.10 are reserved for address digits 0 to 9.

#### **drop**

If this signal is received from the CO, the disconnect sequence is initiated by switch and the call drops.

### **end-of-ani**

If ANI digits are sent to the CO, a signal is sent to indicate the end-of-ANI digits. When incoming ANI is received, this signal indicates the end-of-ani digits. This signal is used on both DOD and DID calls.

### **end-of-dial**

The CO sends this signal to indicate the end-of-dial digits. The switch responds with a request for a group II signal. This signal is used when open numbering is used on DID calls.

### **end-of-digits**

This signal is sent by the origination switch when making outgoing calls, sending digits, and receiving a next-digit group A signal from the destination switch when there are no more digits to be sent.

This signal also may be sent when the switch does not have end-of-ani assigned, is making an outgoing call, is sending ANI, and is receiving a call-info-ani group A signal from the destination switch when there are no more ANI digits to be sent.

If both end-of-digits and end-of-ani are assigned, the switch uses end-of-an after sending the last ANI digit and end-of-digits after sending the last called-number digit.

### **ignored**

If this signal is received from the CO, it is acknowledged by a corresponding signal (that is, A.1, and so on) from the switch but no action is taken in the response and it is not counted as a digit. When this signal is received in countries other than Belgium, it is acknowledged. In Belgium, it is not acknowledged.

### **maint-call**

The CO sends a signal to indicate that a call is a maintenance call. This signal may be used on DID calls in Saudi Arabia. If the switch receives this tone, it prepares the special maintenance call sequences for the CO depending on the type of maintenance call.

### **send-congestion**

If the switch receives this signal from the CO on a DID call, it returns a congestion signal (group A) to the CO. The congestion signal is sent in compel mode rather than in pulse mode.

## **Group II signals**

Group II signals are a more elaborate set of forward signals generated by the originating switch, as follows:

### **attendant**

If the switch receives this signal on DID calls, the call terminates at an attendant regardless of the extension dialed. On DOD calls, this signal is sent to the CO if the CO requests calling-category information and the originating extension is an attendant. This signal is used on both DID and DOD calls.

### **busy-rt-attd**

If the switch receives this signal on DID calls, the call terminates at an attendant if the called extension is busy or at the called extension if it is not busy. This signal is used on DID calls.

### **data-call**

If the switch receives this signal on DID calls and the terminating extension is not a data extension, intercept treatment is given. On DOD calls, this signal is sent to the CO if the CO requests calling-category information and the originating extension is a data extension. This signal is used on both DID and DOD calls.

### **drop**

If this signal is received from the CO, the disconnect sequence is initiated by switch and the call drops.

### **maint-call**

If the CO sends this signal to the switch on a DID call, the call is a maintenance call. When the switch receives this signal, it prepares a special maintenance sequence for the call. The sequence depends upon the type of maintenance call expected.

### **normal**

This signal is used to indicate that the caller is a normal subscriber. If it is received on a DID call, the call is terminated at the called extension. For an outgoing MF signaling call that uses group II signaling, this signal is sent to the CO when the CO requests calling-category information and the originating extension is a station. This signal is used in both DID and DOD calls.

### **send-intercept**

If the switch receives this signal from the CO on a DID call, it returns group B intercept signal to the CO.

### **toll-auto**

This signal indicates that a call is an automatic toll call. When the call terminates at a busy station and a special busy signal is defined, the busy signal is sent to the CO. You can define the special busy signal by choosing the option toll-busy on the incoming group B signals. This signal is used in China.

## **toll-operator**

This signal, used in China, is treated as a normal subscriber signal. See the normal definition.

## **Group A signals**

Group A signals are basic backward signals generated by the destination switch, as follows:

### **send-ani**

The CO sends this signal to request calling-party category and sends additional signals to request ANI digits. This signal is sent to the CO when DEFINITY ECS requests ANI digits on DID calls. This signal is used on both DOD and DID calls.

### **congestion**

The CO sends this signal to indicate that it is experiencing network congestion. When the switch receives this signal on DOD calls, the switch drops the trunk and plays reorder tone to the calling party. This signal is used on DOD calls.

### **drop**

When this signal is sent, the receiving switch initiates disconnect sequence.

### **end-of-dial**

This signal is sent to indicate the end of the address digit string. For MF group II calls, this signal requests a group II signal and switches the sender over to the group B signaling mode. This signal is used on both DID and DOD calls.

### **resend-digit**

The switch sends this signal to adjust the outpulsing pointer so that the last digit can be resent again. This signal is used on DOD calls.

### **last-digit**

The switch sends this signal to adjust the outpulsing pointer so that the last 2 digits can be resent. This signal is used on DOD calls.

### **last-2-digits**

The switch sends this signal to adjust the outpulsing pointer so that the last 3 digits can be resent. This signal is used on DOD calls.

### **last-3-digits**

The switch sends this signal to adjust the outpulsing pointer so that the last 4 digits can be resent. This signal is used on DOD calls.

### **next-digit**

The switch sends this signal to request the next digit. This signal is used on both DID and DOD calls.

### **next-ani-digit**

The switch sends this signal to request the next ANI digit. This signal is used on DID and DOD calls.

### **restart**

The switch sends this signal to request the whole digit string again. This signal is used on DOD calls.

### **setup-sppath**

The CO sends this signal to the switch to set up a speech path. This signal is used on DOD calls and on DID calls in Belgium.

## **Group B signals**

Group B signals enhance group A signals for backward signaling from the destination switch by providing the status of the called party. In addition, if the originating switch uses group II signals, the destination switch answers with group B signals. Group B signals are as follows:

### **busy**

This signal is sent to indicate that the called party is busy. On DID calls, the signal is sent to the CO if there is no coverage point to terminate the call. If the switch receives this signal on DOD calls, it plays busy tone to the calling party and drops the trunk.

### **congestion**

This signal is sent to indicate that the system is congested and the call cannot be terminated successfully. On DID calls, the signal is sent to the CO to indicate that a resource is not available. On DOD calls, if the switch receives this signal, reorder tone is played to the calling party and the trunk is dropped.

### **free**

This signal is sent to indicate that the called party is idle. On DID calls, the signal is sent to the CO to indicate that the called party is idle and the call is terminated successfully. If the switch receives this signal on DOD calls, it connects the trunk to the calling party.

### **intercept**

This signal is sent to indicate that the called party number is not in service or is not correct. On DID calls, if intercept treatment is set to provide a tone, tone is sent to the CO to indicate that the called number is not valid. If the switch receives the signal on DOD calls, the switch plays intercept tone to the calling party and drops the trunk.

### **toll-busy**

This signal, used in China, is sent to indicate that the called party is busy if the call is an automatic toll call.

## Music Sources

---

This form defines music sources for Tenant Partitions. Each music source defined on the form can be used by one or more Tenant Partitions. However, a partition may have only one music source.

 **NOTE:**

If you use equipment that rebroadcasts music or other copyrighted materials, you may be required to obtain a copyright license from, or pay fees to, a third party such as the American Society of Composers, Artists, and Producers (ASCAP) or Broadcast Music Incorporated (BMI). You can purchase a Magic Hold<sup>®</sup> system, which does not require such a license, from Lucent Technologies.

### Administration commands

---

This form is accessible only if `Tenant Partitioning` is enabled on the System-Parameters Customer-Options form.

You can use the change and display commands to administer the Tenant Partitions. The syntax for executing these commands is provided below.

| Action  | Object        | Qualifier <sup>1</sup> |
|---------|---------------|------------------------|
| change  | music-sources |                        |
| display | music-sources | [print or schedule]    |

---

1. Brackets indicate that the qualifier is optional.

 **NOTE:**

The maximum number of music sources is 20 for GAZ and 100 for MIPS.

**Form instructions**

**Page 1 of the Music Sources form**

| Music Sources |       |         |                | Page 1 of X |
|---------------|-------|---------|----------------|-------------|
| Source        | Type  | Port    | Description    |             |
| 1             | music | 01A1003 | Easy listening |             |
| 2             | tone  |         | Tone-on-Hold   |             |
| 3             | music | 01A1004 | Rock           |             |
| 4             | none  |         |                |             |
| 5             | none  |         |                |             |
| 6             | none  |         |                |             |
| 7             | music | 12B1301 | Oldies         |             |
| 8             | none  |         |                |             |
| 9             | none  |         |                |             |
| 10            | none  |         |                |             |
| 11            | music | 04C2003 | Classical      |             |
| 12            | none  |         |                |             |
| 13            | none  |         |                |             |
| 14            | none  |         |                |             |
| 15            | none  |         |                |             |

**Screen 5-124. Music Sources form sample (page 1)**

- **Source** — This is a display only field.
- **Type** — Enter the type of treatment to be provided by the music source. The options are **music**, **tone**, or **none**. If you entered a value in Music/Tone on Hold on the Feature-Related System Parameters form, that value will appear in this field. Only one music source is allowed to use tone-on-hold.
- **Port** — This field appears only if you entered **music** in Type. Enter the auxiliary trunk or analog port address of the music source. Duplicates are not allowed.
- **Description** — This field appears only if you entered **music** or **tone** in Type. Enter a 20 character (maximum) description of the administered music source.



**NOTE:**

When Tenant Partitioning is enabled, Music/Tone on Hold on the Feature-Related System Parameters form disappears. However, the value in that field (tone, music, or none) will appear as the first entry on the Music Sources form. If the value was **music**, the port number will also appear on the Music Sources form. When Tenant partitioning is disabled, Music/Tone on Hold reappears on the Feature-Related System Parameters form, along with and the values from the Music Sources form.



## **Implementation notes**

---

Page 2, for R5vs/si and later configurations, and pages 2 through 4, for G3r, contain the same information as Page 1, and do not display here to conserve space. Remember that the maximum number of music sources for R5vs/si and later configurations is 20 and the maximum for G3r is 100.

## Packet Gateway Board

This form administers the Packet Gateway (PGATE) circuit pack.

**⇒ NOTE:**

The PGATE form only displays for R5r and later configurations.

### Administration commands

Use the following commands to access the PGATE form.

| Action  | Object | Qualifier   |
|---------|--------|---|
| add     | pgate  | Enter the circuit pack cabinet, carrier, and slot |
| change  | pgate  | Enter the circuit pack cabinet, carrier, and slot |
| display | pgate  | Enter the circuit pack cabinet, carrier, and slot |
| remove  | pgate  | Enter the circuit pack cabinet, carrier, and slot |

### Form instructions

Make assignments as required for the following fields on the form:

#### Page 1 of the form

PACKET GATEWAY BOARD Page 1 of 1

Board Location: \_\_\_\_\_ Name: \_\_\_\_\_

Application: X.25

External cable type: rs232

Port configuration: 1) rs232 2)rs232 3)rs232 4)rs232

#### Screen 5-125. Packet Gateway Board form

- **Board Location** — Enter five characters. The first two represent the cabinet (01 to 22). The third represents the carrier (A through E). The fourth and fifth are the slot numbers within the carrier (01 to 20 for medium cabinets, 01 to 18 for XE cabinets).
- **Name** — Enter up to 15 alphanumeric characters as the name of the adjunct with which the PGATE circuit pack communicates.

- **Application** — A display-only field indicating that the communications protocol used to transmit messages over the PGATE is "X.25".
- **External Cable Type** — A display-only field indicating that "rs232" is the type of physical interface being used between the PGATE port and the adjunct.
- **Port Configuration** — A display-only field indicating that the port is configured for "rs232" communication.

## Processor Channel Assignment for R5r and later Installations

This form assigns Processor Channels to the System's interface links and hop channels for R5r and later configurations.

### Administration commands

Use the following commands to administer the Processor Channel Assignment form.

| Action  | Object                  | Qualifier <sup>1</sup>                     |
|---------|-------------------------|--|
| change  | communication-interface | processor channels                         |
| display | communication-interface | processor channels ['print' or 'schedule'] |

1. Brackets [ ] indicate the qualifier is optional. Single quotes ( ' ' ) indicate the text inside the quote must be entered exactly as shown or an abbreviated form of the word may be entered.

### Form instructions

Make assignments as required for the following fields on each page of the form:

#### Pages 1 through 8 of the form

| Proc<br>Chan | Application | PROCESSOR CHANNEL ASSIGNMENT |               |                |                 |       | Page 1 of 8 |
|--------------|-------------|------------------------------|---------------|----------------|-----------------|-------|-------------|
|              |             | Interface<br>Link            | Local<br>Chan | Remote<br>Port | Adjunct<br>Port | Name  | Machine-ID  |
| 1:           | _____       | ___                          | ___           | ___            | ___             | _____ | ___         |
| 2:           | _____       | ___                          | ___           | ___            | ___             | _____ | ___         |
| 3:           | _____       | ___                          | ___           | ___            | ___             | _____ | ___         |
| 4:           | _____       | ___                          | ___           | ___            | ___             | _____ | ___         |
| 5:           | _____       | ___                          | ___           | ___            | ___             | _____ | ___         |
| 6:           | _____       | ___                          | ___           | ___            | ___             | _____ | ___         |
| 7:           | _____       | ___                          | ___           | ___            | ___             | _____ | ___         |
| 8:           | _____       | ___                          | ___           | ___            | ___             | _____ | ___         |
| 9:           | _____       | ___                          | ___           | ___            | ___             | _____ | ___         |
| 10:          | _____       | ___                          | ___           | ___            | ___             | _____ | ___         |
| 11:          | _____       | ___                          | ___           | ___            | ___             | _____ | ___         |
| 12:          | _____       | ___                          | ___           | ___            | ___             | _____ | ___         |
| 13:          | _____       | ___                          | ___           | ___            | ___             | _____ | ___         |
| 14:          | _____       | ___                          | ___           | ___            | ___             | _____ | ___         |
| 15:          | _____       | ___                          | ___           | ___            | ___             | _____ | ___         |
| 16:          | _____       | ___                          | ___           | ___            | ___             | _____ | ___         |

- **Proc Chan** — This field is display-only and indicates each of the processor channels.
- **Application** — Enter the type of application that connects to this processor channel. Valid entries are noted in the Application Entry column in [Table 5-4](#).

**Table 5-4. Applications**

| Application Entry | Processor Description                |
|-------------------|--------------------------------------|
| audix             | AUDIX                                |
| cpn/bn            | CPN/BN (ISDN Gateway)                |
| dcs               | DCS                                  |
| gateway           | ISDN Over PRI D-channel Gateway      |
| mis               | CMS                                  |
| msaamwl           | MSA Automatic Message Waiting Lamp   |
| msack             | Switch/MSA Clock Synchronization     |
| msahlwc           | MSA High Priority Leave Word Calling |
| msallwc           | MSA Low Priority Leave Word Calling  |
| msamcs            | MSA Message Center Service           |

- **Interface Link** — Enter the interface link (1 to 16) to connect the processor channel to.
- **Interface Chan** — This field, together with `Interface Link`, identifies the link/channel pair that is associated with the local processor channel. Enter a number from 1 to 64 to identify the interface channel that is associated with the local processor channel. The Interface Link/Channel association establishes a network channel to the remote machine. (This field and `Interface Chan` must be assigned as a pair or both left blank).



**NOTE:**

Once a Link/Channel Pair is assigned on the Processor Channel Assignments form, the pair cannot be assigned on the Hop Channel Assignments form (for more information, see [“Hop Channel Assignments Form”](#) on page 12-116).

- **Local Port** — The port (1 to 64) on which this PBX expects the connection to be established.
- **Remote Port** — The port (1 to 64) on which the far end expects the connection to be established.

**5 Basic Forms**

*Processor Channel Assignment for R5r and later Installations*

For a far end, this Remote Port entry should match the far end's Local Port entry. Generally, the local and remote port values are administrable on both ends of the connection, and it is required that the local port (administered on one end) match the remote port (administered on the other). The terms "local port" and "remote port" are called different things on different switches and adjuncts, so care must be taken to make sure the correct numbers match. In addition, the "logical channel" (sometimes called the "interface channel") must be the same at both ends of the connection.

For each application, the following table shows the expected "Application Field" value, and what values on the far end must be matched with the values on the local machine for remote port, local port, and logical channel. The specifications in the table are those used on the far end adjunct or switch. For example:

- On other switches and the AUDIX adjunct the logical channel and local and remote port values are administrable, so whatever values are administered on the far-end must be matched appropriately (see table) on the local switch.
- For CMS and the ISDN Gateway (CPN/BN) adjuncts, the logical channel is administrable through the X.25 package administration. The local port and remote port can be administered via the application (for example, CMS or ISDN Gateway) package.
- On the 3B2 messaging server adjunct (MSA) five processor channels (for each of the five different "msa" application types) must be administered. The logical channel and remote port are dictated by the application field. Only the message server number is administrable (to indicate which of the 7 possible message servers this is) on the MSA itself. The local port depends upon the MSA number (to indicate the port the MSA will direct the connection to). The values shown in the next table are for MSAs numbered 1 through 7, respectively.

| <b>Application</b> | <b>Application Held Value</b> | <b>Logical Channel Value</b> | <b>Local Port Value</b> | <b>Remote Port Value</b> |
|--------------------|-------------------------------|------------------------------|-------------------------|--------------------------|
| System 75          | dcs                           | IF chan. no.                 | remote proc. chan. no.  | proc. chan. no.          |
| Definity G1        | dcs                           | IF chan. no.                 | remote proc. chan. no.  | proc. chan. no.          |
| Definity G3i       | dcs                           | IF chan. no.                 | remote proc. chan. no.  | proc. chan. no.          |
| System 85          | dcs                           | IF chan. no.                 | remote port no.         | local port no.           |
| Definity G2        | dcs                           | IF chan. no.                 | remote port no.         | local port no.           |
| Definity G3r       | dcs                           | IF chan. no.                 | remote port no.         | local port no.           |

*Continued on next page*

5 Basic Forms

Processor Channel Assignment for R5r and later Installations

| Application  | Application Held Value | Logical Channel Value | Local Port Value    | Remote Port Value |
|--------------|------------------------|-----------------------|---------------------|-------------------|
| AUDIX        | audix                  | logical chan. no.     | switch port no.     | audix port no.    |
| CMS          | mis                    | logical chan. no.     | remote port no.     | local port no.    |
| ISDN Gateway | cpn/bn                 | logical chan. no.     | remote port no.     | local port no.    |
| MSA          | msamcs                 | 1                     | 1,10,15,30,38,46,54 | 1                 |
| MSA          | msahlwc                | 2                     | 2,11,16,31,39,47,55 | 2                 |
| MSA          | msallwc                | 3                     | 3,12,17,32,40,48,56 | 3                 |
| MSA          | msaamwl                | 4                     | 4,13,18,33,41,49,57 | 4                 |
| MSA          | msack                  | 8                     | 8,9,14,19,37,45,53  | 8                 |

- **Adjunct Name** — The AUDIX or MSA Application chooses which Adjunct this processor channel is communicating with (names are from the Adjunct Names form).
- **Machine-ID** — Enter the Machine ID number (1 to 99, or blank) associated with the port if Application is **dcs**, **audix**, or **cpn/bn**. When supporting AUDIX, the Machine ID must agree with the AUDIX field entry on the AUDIX System Translations — Switch-Connection form (part of AUDIX translations). Typically, with just one AUDIX, this entry is 1.

## Processor Channel Assignment for R5si and later Installations

---

Used to assign Processor Channels to the System's interface links for R5si and later configurations.

### Administration commands

---

Use the following commands to administer the Processor Channel Assignment form.

| Action  | Object                  | Qualifier <sup>1</sup>                     |
|---------|-------------------------|--|
| change  | communication-interface | processor channels                         |
| display | communication-interface | processor channels ['print' or 'schedule'] |

- 
1. Brackets [ ] indicate the qualifier is optional. Single quotes ( ' ' ) indicate the text inside the quote must be entered exactly as shown or an abbreviated form of the word may be entered.

### Form instructions

---

Make assignments as required for the following fields on each page of the form:



Pages 1 through 4 of the form

| PROCESSOR CHANNEL ASSIGNMENT |       |           |      |          |           |   | Page 1 of 4 |
|------------------------------|-------|-----------|------|----------|-----------|---|-------------|
| Proc Chan                    | Appl. | Interface |      | Priority | Remote    |   | Machine-ID  |
|                              |       | Link      | Chan |          | Proc Chan |   |             |
| 1:                           | _____ | -         | -    | _____    | -         | - | _____       |
| 2:                           | _____ | -         | -    | _____    | -         | - | _____       |
| 3:                           | _____ | -         | -    | _____    | -         | - | _____       |
| 4:                           | _____ | -         | -    | _____    | -         | - | _____       |
| 5:                           | _____ | -         | -    | _____    | -         | - | _____       |
| 6:                           | _____ | -         | -    | _____    | -         | - | _____       |
| 7:                           | _____ | -         | -    | _____    | -         | - | _____       |
| 8:                           | _____ | -         | -    | _____    | -         | - | _____       |
| 9:                           | _____ | -         | -    | _____    | -         | - | _____       |
| 10:                          | _____ | -         | -    | _____    | -         | - | _____       |
| 11:                          | _____ | -         | -    | _____    | -         | - | _____       |
| 12:                          | _____ | -         | -    | _____    | -         | - | _____       |
| 13:                          | _____ | -         | -    | _____    | -         | - | _____       |
| 14:                          | _____ | -         | -    | _____    | -         | - | _____       |
| 15:                          | _____ | -         | -    | _____    | -         | - | _____       |
| 16:                          | _____ | -         | -    | _____    | -         | - | _____       |

Screen 5-127. Processor Channel Assignment — R5si and later form (page 1 of 4)

- **Proc Chan** — This field is display-only and indicates each of the 64 processor channels.
- **Appl.** — Enter the type of application that connects to this processor channel. Valid entries are noted in the Entry column in the "Processor Channel Applications" table that follows.

**NOTE:**  
 MSA applications, if administered, must be assigned to fixed processor and remote processor (MSA) channels (1, 2, 3, 4, and 8, respectively) as shown on the table. Therefore, it is recommended that channels 1, 2, 3, 4, and 8 be reserved for Messaging Server Adjunct (MSA) connectivity since the MSA uses fixed channel numbers.

**NOTE:**  
 Channel 10 should be reserved for MIS and Channel 59 for AUDIX.

When the Management Information System (MIS) adjunct processor is a Messaging Server Adjunct, the `Appl` field must be **msamis**. For MIS 3B adjunct processors, `Appl` is set to **mis**.

If `Appl` is administered as **isdn**, then no other channels may use the interface link specified for this processor channel. A link used for ISDN-PRI cannot be multiplexed to provide other applications.

5 Basic Forms

Processor Channel Assignment for R5si and later Installations

When "OCM" is used, the associated interface link may be used to interface either an Outbound Call Management (OCM) adjunct or and ISDN Gateway adjunct (supports CPN/BN applications) but not both.

If a processor channel is not assigned, leave this field blank.

| Appl. Entry | Processor Description                | Channel | Priority |
|-------------|--------------------------------------|---------|----------|
| audix       | AUDIX                                | 59      | high (h) |
| dcs         | DCS                                  | -       | high (h) |
| isdn        | ISDN-PRI                             | -       | high     |
| mis         | MIS                                  | 10      | low (l)  |
| msaamwl     | MSA Automatic Message Waiting Lamp   | 4       | low (l)  |
| msaclk      | Switch/MSA Clock Synchronization     | 8       | high (h) |
| msahlwc     | MSA High Priority Leave Word Calling | 2       | high (h) |
| msallwc     | MSA Low Priority Leave Word Calling  | 3       | low (l)  |
| msamcs      | MSA Message Center Service           | 1       | high (h) |
| msamis      | MSA/MIS                              | -       | low (l)  |
| OCM         | Outbound Call Management             | -       | high     |

- **Interface Link** — Enter a number from **1** to **8** for multi-carrier cabinets (**1** to **4** for single-carrier cabinets) to identify the interface link/channel pair used to establish a connection to the remote machine. (This field and `Interface Chan` must be assigned as a pair or both left blank except when `Appl` is **isdn**.) This is the link number assigned on the Processor Interface Data Module form.
- **Interface Chan** — This field, together with `Interface Link`, identifies the link/channel pair that is associated with the local processor channel. Enter a number from **1** through **64** to identify the interface channel that is associated with the local processor channel. The Interface Link/Channel association establishes a network channel to the remote machine. (This field and `Interface Chan` must be assigned as a pair or both left blank except when `Appl` is **isdn**.)

Once a Link/Channel Pair is assigned on the Processor Channel Assignments form, the pair cannot be assigned on the Hop Channel Assignments form (for more information, see [“Hop Channel Assignments Form” on page 12-116](#)).

- **Priority** — Enter **h** (high) or **l** (low) to indicate the priority of this processor channel. High-priority channels have precedence over the low-priority channels. Assignments should be made based on the operational speed of the links and the number of hops in the network channel. Enter the appropriate priority (as per the "Processor Channel Applications" table).
- **Remote Proc Chan** — Cannot be assigned when `App1` is **isdn**. Enter the processor channel number (**1** through **64**) of the remote switch that connects to the local processor channel.
- **Machine-ID** — Enter the Machine ID number associated with the port if `App1` is **dcs**, **audix**, or **ocm**; otherwise, leave this field blank. Machine-IDs are administered as part of the Uniform Dial Plan (UDP). Valid entries are **1** through **99** or leave blank. When supporting AUDIX, the Machine ID must agree with the AUDIX field entry on the AUDIX Data Link form (part of AUDIX translations). Typically, with just one AUDIX, this entry is **1**.

## Pickup Group

This form implements call pickup groups with up to 50 extensions per group. A pickup group is a group of users authorized to answer calls to a voice terminal extension within that group of users. A voice terminal extension number can only belong to one pickup group.

### Administration commands

Use the following commands to administer the Pickup Group form.

|                     | Action  | Object         | Qualifier <sup>1</sup>   |
|---------------------|---------|----------------|--|
| Without Hospitality | add     | pickup-group   | 1-MAX (or 'next')  |
| Parameter Reduction | change  | pickup-group   | 1-MAX  |
| Feature             | display | pickup-group   | 1-MAX ['print' or 'schedule']  |
|                     | list    | intercom-group | [1-MAX]['number' x]['to-number' x]['count' n]<br>['print' or 'schedule'] |
|                     | remove  | pickup-group   | 1-MAX  |
| With Hospitality    | add     | pickup-group   | 1-5 (or 'next')  |
| Parameter Reduction | change  | pickup-group   | 1-5  |
| Feature             | display | pickup-group   | 1-5 ['print' or 'schedule']  |
|                     | list    | intercom-group | [1-5]['number' x]['to-number' x]['count' n]<br>['print' or 'schedule']   |
|                     | remove  | pickup-group   | 1-5  |

1. Brackets [ ] indicate the qualifier is optional. Single quotes ( ' ' ) indicate the text inside the quote must be entered exactly as shown or an abbreviated form of the word may be entered. MAX is the maximum number available in your system configuration.

## Form instructions

---

Make assignments as required for the following fields on each page of the form:

### Pages 1 and 2 of the form

```

Page 1 of 2
PICKUP GROUP
Group Number: 1
GROUP MEMBER ASSIGNMENTS
Ext      Name
1: 51001 27 character station 51001 14: 51002 27 character station 51002
2:
3:
4:
5:
6:
7:
8:
9:
10:
11:
12:
13:
14:
15:
16:
17:
18:
19:
20:
21:
22:
23:
24:
25:
```

### Screen 5-128. Pickup Group form (page 1 of 2)

- **Group Number** — Enter a Pickup Group number when completing a paper form. This is a display-only field when the form is accessed using an administration command such as **add** or **change**. If `Hospitality Parameters Reduction` is enabled on the `System-Parameters Customer-Options` form, only five (maximum) group numbers may be assigned.
- **Ext** — Enter the extension number of each user in the group. A VDN cannot be assigned to a Call Pickup group.
- **Name** — Make no entry. The name is assigned to the above extension number when the users and their associated extensions were administered.

## Remote Access

---

### SECURITY ALERT:

*Lucent Technologies has designed the Remote Access feature incorporated in this product that, when properly administered by the customer, will enable the customer to minimize the ability of unauthorized persons to gain access to the network. It is the customer's responsibility to take the appropriate steps to properly implement the features, evaluate and administer the various restriction levels, protect access codes and distribute them only to individuals who have been advised of the sensitive nature of the access information. Each authorized user should be instructed concerning the proper use and handling of access codes.*

*In rare instances, unauthorized individuals make connections to the telecommunications network through use of remote access features. In such an event, applicable tariffs require that the customer pay all network charges for traffic. Lucent Technologies cannot be responsible for such charges, and will not make any allowance or give any credit for charges that result from unauthorized access.*

To assist you in maintaining the security of your system, DEFINITY ECS provides the Status Remote Access command, which provides information and status on each remote access barrier code and on the remote access feature. A sample Status Remote Access screen follows the Remote Access form.

The Remote Access form is used to implement the Remote Access feature. Remote Access permits a caller located outside the System to access the System through the public or private network and then use the features and services of the System.

Remote Access users can dial into the System using Central Office, Foreign Exchange, WATS, and ISDN-PRI trunks. In addition, a dedicated Remote Access Direct Inward Dialing number can be provided.

To ensure the security of your system, consider the following:

1. All remote access facilities should be unlisted directory telephone numbers.
2. Users should be required to enter a Barrier Code of seven random digits AND an Authorization Code of at least seven random digits to make network calls.
3. Authorization Codes should be nonconsecutive (random) and changed at least quarterly.
4. Deactivate Authorization Codes immediately if the user leaves the company or changes assignments.
5. Each Authorization Code should have assigned the minimum level of calling permissions required.

6. When possible, block off-hours and weekend remote access calling. Use Alternative Facility Restriction Levels, if available.
7. Use a voice recording, warble tone, or no tone and avoid use of a dial tone as a prompt when the remote access unit answers.
8. Assign the lowest possible FRL to only allow internal PBX calls.

As an additional step to ensure System security, you can permanently disable the Remote Access feature if you do not intend to use it now or in the future. If you do decide to permanently disable the feature, it will require Services intervention to activate the feature again.

**⚠ CAUTION:**

*Your attempt to disable the Remote Access feature will be lost if the switch is rebooted without saving translations. Therefore, execute a "save translation" command after permanently disabling the Remote Access feature.*

**Administration commands**

---

Use the following commands to administer the Remote Access form. In some cases, just the most commonly used commands are shown. See [Appendix B, "Administration Commands"](#), for a complete listing of all administration commands, the command structure, and the use of abbreviated command words when entering a command.

| Action  | Object        | Qualifier <sup>1</sup>  |
|---------|---------------|-------------------------|
| change  | remote-access | —                       |
| display | remote-access | ['print' or 'schedule'] |
| list    | remote-access |                         |
| status  | remote-access | ['print']               |

---

1. Brackets [ ] indicate the qualifier is optional. Single quotes ( ' ) indicate the text inside the quote must be entered exactly as shown or an abbreviated form of the word may be entered.

**Form instructions**

```

                                REMOTE ACCESS
Remote Access Extension_____ Barrier Code Length____
Authorization Code Required? y Remote Access Dial Tone: n
Barrier Code COR TN COS Expiration Date No. of Calls Calls Used
1:_____ 1__ 1__ 1__ _/_/_/___ _____
2:_____ 1__ 1__ 1__ _/_/_/___ _____
3:_____ 1__ 1__ 1__ _/_/_/___ _____
4:_____ 1__ 1__ 1__ _/_/_/___ _____
5:_____ 1__ 1__ 1__ _/_/_/___ _____
6:_____ 1__ 1__ 1__ _/_/_/___ _____
7:_____ 1__ 1__ 1__ _/_/_/___ _____
8:_____ 1__ 1__ 1__ _/_/_/___ _____
9:_____ 1__ 1__ 1__ _/_/_/___ _____
10:_____ 1__ 1__ 1__ _/_/_/___ _____
Permanently Disable? __ Disable Following A Security Violation? y
(NOTE: You must logoff to effect permanent disabling of Remote Access)
    
```

**Screen 5-129. Remote Access form (page 1 of 1)**

```

                                REMOTE ACCESS STATUS

Remote Access Status: enabled
Date/Time Modified: 01/30/95 17:00

Barrier Date Expiration No. of Calls Status Date/Time Expired Cause
Code Modified Date Calls Used
1:2374745 01/30/95 03/31/95 50 50 expired 02/15/95 20:43 calls
2:3374837 01/30/95 / / 20 4 active / / :
3:3285038 01/30/95 01/31/96 13 expired 02/10/95 09:32 date
4:5738557 01/30/95 07/31/95 20 20 expired 02/03/95 10:14 calls
5:7764884 01/30/95 05/20/95 0 active / / :
6: / / / / / / / / :
7: / / / / / / / / :
8: / / / / / / / / :
9: / / / / / / / / :
10: / / / / / / / / :
    
```

**Screen 5-130. Remote Access Status form**

Make assignments as required for the following fields on the form:

- **Remote Access Extension** — Enter an extension number (cannot be a VDN extension) for Remote Access. This extension is associated with each trunk that supports the Remote Access feature. This field can be left blank if no barrier code is assigned and the Remote Access feature is not accessible. The default for this field is blank. The remote access extension



is used as if it was a DID extension. Only one DID extension can be assigned as the remote access extension. Calls to that number are treated the same as calls on the remote access trunk.

When a trunk group is dedicated to Remote Access, the remote access extension number is administered on the trunk group's incoming destination field.

- **Barrier Code Length** — Enter the desired barrier code length (4 to 7 digits), or leave this field blank indicating that a barrier is not required. Assigning a barrier code length of 7 provides maximum security.
- **Authorization Code Required** — Enter **y** if an authorization code must be dialed by Remote Access users to access the system's Remote Access facilities. Default is **n**. Use of an authorization code in conjunction with barrier codes increases the security of the Remote Access feature.
- **Remote Access Dial Tone** — This field appears on the form if `Authorization Code Required` is **y**. Enter **y** in this field if Remote Access Dial Tone is required, as a prompt to the user, to enter an authorization code to access Remote Access. Enter **n** if Remote Access Dial Tone is not required as a prompt.
- **Barrier Code** — Assign a barrier code that conforms to the number entered in Barrier Code Length. All codes must be a 4- to 7-digit number. The code can be any combination of the digits 0 through 9. If Barrier Code Length is blank, the first `Barrier Code` field must be specified as **none**. Duplicate entries are not allowed. The system default for this field is a blank. Assign a 7-digit number in this field for maximum security.
- **COR** — Enter the class of restriction (COR) number (**0** through **95**) associated with the barrier code that defines the call restriction features. Default is **1**. Assigning the most restrictive COR that provides only the level of service required, will provide the maximum security.
- **TN** — Enter the Tenant Partition number. Default is **1**.
- **COS** — Enter a class of service (COS) number (**0** through **15**) associated with the barrier code that defines access permissions for Call Processing features. Default is **1**. Assigning the most restrictive COS that provides only the level of service required provides the maximum security.
- **Expiration Date** — Assign an expiration date based on the expected length of time the barrier code will be needed. Enter the date the remote access barrier code will expire. Valid entries are a date greater than the current date or a blank. Default is tomorrow's date. If it is expected that the barrier code will be used for a 2-week period, assign a date two weeks from the current date. If the Expiration Date is assigned, a warning message is displayed on the system copyright screen seven days prior to the expiration date. The system administrator can modify the expiration date to extend the time interval if needed.
- **No. of Calls** — This field specifies the number of Remote Access calls that can be placed using the associated barrier code. Valid entries are any number from 1 to 9999 or a blank. The default is one call. The

Expiration Date and No. of Calls fields can be used independently or in conjunction to provide the maximum security. If both the Expiration Date and No. of Calls fields are assigned, the corresponding barrier code expires when the first of these criteria is satisfied.

- **Calls Used** — This is a display-only field that specifies the number of calls that have been placed using the corresponding barrier code. This field is incremented each time a barrier code is successfully used to access the Remote Access feature. A usage that exceeds the expected rate can indicate improper use.
- **Permanently Disable** — A **y** in this field permanently disables the Remote Access feature. Once you have set this field to **y**, you permanently block access to the administration interface. Reactivation of access to the interface requires Lucent Services intervention.
- **Disable Following a Security Violation** — A **y** in this field disables the remote access feature following detection of a remote access security violation. This field appears on the form if the remote access component of the SVN feature is enabled. The system administrator can re-enable Remote Access with the “enable remote access” command. This field appears on the form if the remote access component of the SVN feature is enabled.

## Remote Call Coverage Table

The Remote Call Coverage Table allows you to provide automatic redirection of certain calls to alternate off-net answering positions in a Coverage path for any valid dialed number up to 16 digits that begins with an Automatic Alternate Routing (AAR) or Automatic Route Selection (ARS) feature access code (FAC), outgoing trunk dial access code (TAC), or UDP/DCS extension.

### Administration commands

Use the following commands to administer the Remote Call Coverage form.

| Action  | Object   | Qualifier |
|---------|----------|-----------|
| change  | coverage | remote    |
| display | coverage | remote    |

### Form instructions

Make assignments as required for the following fields on the form:

Enter coverage points into the numbered fields on the form. Valid coverage points are valid dialed numbers up to 16 digits that begin with an AAR or ARS FAC, outgoing trunk TAC, or UDP/DCS extension. Up to 999 remote call coverage points can be entered on the 23 pages of this form.

#### REMOTE CALL COVERAGE TABLE

|           |           |           |
|-----------|-----------|-----------|
| 01: _____ | 16: _____ | 31: _____ |
| 02: _____ | 17: _____ | 32: _____ |
| 03: _____ | 18: _____ | 33: _____ |
| 04: _____ | 19: _____ | 34: _____ |
| 05: _____ | 20: _____ | 35: _____ |
| 06: _____ | 21: _____ | 36: _____ |
| 07: _____ | 22: _____ | 37: _____ |
| 08: _____ | 23: _____ | 38: _____ |
| 09: _____ | 24: _____ | 39: _____ |
| 10: _____ | 25: _____ | 40: _____ |
| 11: _____ | 26: _____ | 41: _____ |
| 12: _____ | 27: _____ | 42: _____ |
| 13: _____ | 28: _____ | 43: _____ |
| 14: _____ | 29: _____ | 44: _____ |
| 15: _____ | 30: _____ | 45: _____ |

## Second Digit Table

You must complete the Second Digit Table each time you enter **misc** in the digit length of 1 column on the Dial Plan Record form. The second digit table is named for the row where the "misc" appears. In addition, a second digit table can exist for every first digit value.

### Administration commands

Use the following commands to administer the Second Digit Table form.

| Action  | Object       | Qualifier <sup>1</sup> |
|---------|--------------|------------------------|
| add     | second-digit | 0-9                    |
| change  | second-digit | 0-9                    |
| display | second-digit | [print or schedule]    |

1. Brackets [ ] indicate the qualifier is optional.

### Form instructions

Page 1 of 1

SECOND DIGIT TABLE FOR DIGIT \_

| SECOND DIGIT TABLE   |                  |                      |                  |
|----------------------|------------------|----------------------|------------------|
| Digit Identification | Number of Digits | Digit Identification | Number of Digits |
| 0: _____             | 0                | 5: _____             | 0                |
| 1: _____             | 0                | 6: _____             | 0                |
| 2: _____             | 0                | 7: _____             | 0                |
| 3: _____             | 0                | 8: _____             | 0                |
| 4: _____             | 0                | 9: _____             | 0                |

#### Screen 5-132. Second Digit Table form (page 1 of 1)

Make assignments as required for the following fields on the form:

- **Digit** — A display-only field that marks the value of the second digit.
- **Identification** — Enter an abbreviation to identify the dialed number if a particular second digit is dialed. Valid entries are **attd**, **extension**, **tac**, and **fac**. See the first digit table information, in [“Dial Plan Record”](#) above, for explanations of these.

- **Number of Digits** — Enter the length of the dialed number. Valid entries are **2** for attd, **2** through **5** for extension, **2** through **4** for tac (**2** through **3** with DCS), and **2** through **4** for fac.

## Security-Related System Parameters

This form supports the Security Violation Notification feature.

### Administration commands

You can use the change and display commands to administer the Security-Related System Parameters form. The syntax for executing these commands is provided below.

| Action  | Object                     | Qualifier <sup>1</sup>  |
|---------|----------------------------|-------------------------|
| change  | system-parameters security | —                       |
| display | system-parameters security | ['print; or 'schedule'] |

1. Brackets [ ] indicate the qualifier is optional.

### Form instructions

Make assignments as required for the desired fields on the form:

### Page 1 of the form

SECURITY-RELATED SYSTEM PARAMETERS Page 1 of 2

SECURITY VIOLATION NOTIFICATION PARAMETERS

SVN Login Violation Notification Enabled? y  
Originating Extension: \_\_\_\_\_ Referral Destination: \_\_\_\_\_  
Login Threshold: 5\_ Time Interval: 0:03  
Announcement Extension: \_\_\_\_\_

SVN Remote Access Violation Notification Enabled? y  
Originating Extension: \_\_\_\_\_ Referral Destination: \_\_\_\_\_  
Barrier Code Threshold: 10 Time Interval: 0:03  
Announcement Extension: \_\_\_\_\_

SVN Authorization Code Violation Notification Enabled? y  
Originating Extension: \_\_\_\_\_ Referral Destination: \_\_\_\_\_  
Authorization Code Threshold: 10 Time Interval: 0:03  
Announcement Extension: \_\_\_\_\_

Screen 5-133. Security-Related System Parameters form (page 1 of 2)

**SVN Login Violation Notification Enabled** — Set to **y** if you want SVN login violation notification. Default is **n**. If this field is “**y**,” the following fields appear:

- **Originating Extension** — This field requires the entry of an unassigned extension that is local to the switch and conforms to the dial plan for the purpose of originating and identifying SVN referral calls for login security violations. The originating extension initiates the referral call in the event of a login security violation. It also sends the appropriate alerting message or display to the referral destination.
- **Referral Destination** — This field requires an entry of an extension, assigned to a station, attendant console, or vector directory number (VDN) that receives the referral call when a security violation occurs. If a VDN is assigned, the Call Vectoring Time-of-Day routing capability may be used to route the referral call to different destinations based on the time of day or the day of the week. The referral destination must be equipped with a display module unless the Announcement Extension is assigned. Administration of the Announcement Extension is also required if the referral destination is a VDN.
- **Login Threshold** — This field requires an entry of the minimum number of login attempts that are permitted before a referral call is made. The value assigned to this field, in conjunction with Time Interval, determines whether a security violation has occurred. Default is **5**.
- **Time Interval** — This field requires the entry of the time interval in which a login security violation must occur. The range for the time interval is one minute to eight hours (0:01 to 7:59), and is entered in the form "x:xx." For example, if you want the time interval to be one minute, you enter 0:01. If you want the time interval to be seven and one-half hours, you enter 7:30. Default is **0:03**.
- **Announcement Extension** — This field permits entry of a previously administered extension that is assigned to an SVN login violation announcement. Default is blank.

**SVN Remote Access Violation Notification Enabled**— Set to **y** to activate SVN remote access violation notification. Default is **n**. If this field is “**y**,” the following fields appear:

- **Originating Extension** — This field requires the entry of an unassigned extension that is local to the switch and conforms to the dial plan for the purpose of originating and identifying SVN referral calls for remote access barrier code violations. The originating extension initiates the referral call in the event of a Remote Access security violation. It also sends the appropriate alerting message or display to the referral destination.
- **Referral Destination** — This field requires an entry of an extension, assigned to a station, attendant console, or vector directory number (VDN) that receives the referral call when a security violation occurs. If a VDN is assigned, the Call Vectoring Time-of-Day routing capability may be used to route the referral call to different destinations based on the time of day or the day of the week. The referral destination must be equipped with a

display module unless the Announcement Extension is assigned. Administration of the Announcement Extension is also required if the referral destination is a VDN.

- **Barrier Code Threshold** — This field requires an entry of the minimum number of remote access barrier code attempts that are permitted before a referral call is made. The value assigned to this field, in conjunction with Time Interval, determine whether a security violation has occurred. Default is **10**.
- **Time Interval** — This field requires the entry of the time interval in which the remote access barrier code attempts must occur. The range for the time interval is one minute to eight hours (0:01 to 7:59), and is entered in the form "x:xx." For example, if you want the time interval to be one minute, you enter "0:01." If you want the time interval to be seven and one-half hours, you enter "7:30." The system default is **0:03**.
- **Announcement Extension** — This field permits entry of a previously administered extension that is assigned to an SVN remote access barrier code violation announcement. The default is blank.

**SVN Authorization Code Violation Notification Enabled** — Enter **y** to activate SVN authorization code violation notification. Default is **n**. If this field is **y**, the following fields appear:

- **Originating Extension** — This field requires the entry of an unassigned extension that is local to the switch and conforms to the dial plan for the purpose of originating and identifying SVN referral calls for authorization code security violations. The originating extension initiates the referral call in the event of a authorization code security violation. It also sends the appropriate alerting message or display to the referral destination.
- **Referral Destination** — This field requires an entry of an extension, assigned to a station, attendant console, or vector directory number (VDN) that receives the referral call when a security violation occurs. If a VDN is assigned, the Call Vectoring Time-of-Day routing capability may be used to route the referral call to different destinations based on the time of day or the day of the week. The referral destination must be equipped with a display module unless the Announcement Extension is assigned. Administration of the Announcement Extension is also required if the referral destination is a VDN.
- **Authorization Code Threshold** — This field requires an entry of the minimum number of invalid authorization code security violations attempts that are permitted before a referral call is made. The value assigned to this field in conjunction with Time Interval, determines whether a security violation has occurred. Default is **10**.
- **Time Interval** — This field requires the entry of the time interval in which the authorization code security violations must occur. The range for the time interval is one minute to eight hours (0:01 to 7:59), and is entered in



5 Basic Forms

Security-Related System Parameters

Page 5-269

the form "x:xx." For example, if you want the time interval to be one minute, you enter "0:01." If you want the time interval to be seven and one-half hours, you enter "7:30." Default is **0:03**.

- **Announcement Extension** — This field permits entry of a previously administered extension that is assigned to an SVN authorization code violation announcement. Default is blank.

Page 2 of the form

```

                                                                    Page 2 of 2
SECURITY-RELATED SYSTEM PARAMETERS

SECURITY VIOLATION NOTIFICATION PARAMETERS

  SVN Station Security Code Violation Notification Enabled? y
    Originating Extension: _____ Referral Destination: _____
Station Security Code Threshold: 10          Time Interval: 0:03
    Announcement Extension: _____

STATION SECURITY CODE VERIFICATION PARAMETERS

  Minimum Station Security Code Length: 4
  Security Code for Terminal Self Administration Required?

ACCESS SECURITY GATEWAY PARAMETERS

  SYSAM-LCL? n      SYSAM-RMT? n
  MAINT? n         SYS-PORT? n
```

Screen 5-134. Security-Related System Parameters form (page 2 of 2)

**SVN Station Security Code Violation Notification Enabled** — Set to **y** to activate security violation notification for station security codes. Default is **n**. If this field is "**y**," the following fields appear:

- **Originating Extension** — This field requires the entry of an unassigned extension that is local to the switch and conforms to the dial plan for the purpose of originating and identifying SVN referral calls for station security code violations. The originating extension initiates the referral call in the event of a station security code violation. It also sends the appropriate alerting message or display to the referral destination. The originating extension cannot be used for any other purpose.
- **Referral Destination** — This field requires an extension, assigned to a station, attendant console, or vector directory number (VDN), that receives the referral call when a station security code violation occurs. If a VDN is assigned, the Call Vectoring Time-of-Day routing capability may be used to route the referral call to different destinations based on the time of day or the day of the week. The referral destination must be equipped with a

display module unless the Announcement Extension is assigned. Administration of the Announcement Extension is also required if the referral destination is a VDN.

- **Station Security Code Threshold** — This field requires an entry of the minimum number of invalid station security code attempts that are permitted before a referral call is made. The value assigned to this field, in conjunction with Time Interval, determines whether a security violation has occurred. You can enter a value of **1** to **255**; the system default is **10**.
- **Time Interval** — Enter the time interval in which a predetermined number (see *Station Security Code Threshold*, above) of SCC security violations must occur before an SCC security violation notification is sent. The range for the time interval is one minute to eight hours (0:00 to 7:59), and is entered in the form "x:yy," with x representing hours and y representing minutes. For example, if you want the time interval to be one minute, you enter 0:01. If you want the time interval to be seven and one-half hours, you enter 7:30. The system default is **0:03**.
- **Announcement Extension** — This field permits entry of a previously administered extension that is assigned to an SVN station security code violation announcement. The default is blank.

**Minimum Station Security Code Length** — Enter a value of **3–8**. This determines the minimum required length of the Station Security Codes that you enter on the Station form. Longer codes are more secure. If station security codes are used for external access to telecommuting features, the minimum length should be 7 or 8. The default is **4**.

**Security Code for Terminal Self Administration Required?** — Enter **y** (default) to indicate that a security code is required or **n** if a security code is not required.

**Access Security Gateway Parameters** — These fields are operational for Lucent technicians only. The Default is **n**.

## System Parameters Country-Options

This form implements parameters associated with certain international (including North American) call characteristics.

### Administration commands

Use the following commands to administer the Country Options System Parameters form. In some cases, just the most commonly used commands are shown. See [Appendix B, "Administration Commands"](#), for a complete listing of all administration commands, the command structure, and the use of abbreviated command words when entering a command.

| Action  | Object                            | Qualifier <sup>1</sup>  |
|---------|-----------------------------------|-------------------------|
| change  | system-parameters country-options | —                       |
| display | system-parameters country-options | ['print' or 'schedule'] |

1. Brackets [ ] indicate the qualifier is optional. Single quotes ( ' ' ) indicate the text inside the quote must be entered exactly as shown or an abbreviated form of the word can be entered.

### Form instructions

Make assignments as required for the following fields on each page of the form:

#### Page 1 of the form

Page 1 of 7

SYSTEM PARAMETERS COUNTRY-OPTIONS

```

Companding Mode: Mu Law           Base Tone Generation Set: 1
440Hz PBX-dial Tone? n           440Hz Secondary-dial Tone? n
Digital Loss Plan: 10            Version of Digital Loss Plan: B
Analog Ringing Cadence: 1       Set Layer 1 timer T1 to 30 seconds? n
Analog Line Transmission: 1     Enhanced 84xx Display Character Set? n

TONE DETECTION PARAMETERS
Tone Detection Mode: 6           Dial Tone Validation Timer:
Interdigit Pause: short
    
```

- **Companding Mode** — Enter **A-law** or **Mu-law** (default) to identify the companding algorithm to be used by system hardware.
- **Base Tone Generation Set** — Enter a country code (**1** through **19**) to identify the base tone generation set to be used. This field is meaningful only if the system tone detector is a TN780, vintage 4 or a TN2182. Default is **1** (U.S.).



**NOTE:**

A TN780 vintage 5 or greater or a TN2182 is required if Belgian Tones (Country code 8) are specified.

- **440Hz PBX-dial Tone** — Enter **y** or **n** (default) to specify whether the PBX (primary) dial tone will be changed to a continuous 440Hz/-17 tone. Entering **n** implies the tone will either be administered on a later page of this form or, if no individual definition is administered, as defined in `Base Tone Generation Set`.
- **440Hz Secondary-dial Tone** — Enter **y** or **n** (default) to specify whether the Secondary (CO) dial tone will be changed to a continuous 440Hz/-17 tone. Entering **n** implies the tone will either be administered on a later page of this form or, if no individual definition is administered, as defined in `Base Tone Generation Set`.
- **Digital Loss Plan** — Enter a country code (**1** through **17**) to identify the digital loss plan to be used by the system. Default is **1** (U.S.).
- **Version of Digital Loss Plan** — Appears when `Digital Loss Plan` is **10** (country code for UK). Enter **A** or **B** (default) to identify the digital-loss-plan version to be used.
- **Analog Ringing Cadence** — Enter a country code to identify the ringing cadence to be used by analog phones in the system. Default is **1** (U.S.).
- **Set Layer 1 timer T1 to 30 seconds** — Enter **y** or **n** (default) to specify whether the Layer 1 timer is set to 30 seconds.
- **Analog Line Transmission** — Enter the country code the corresponds to the transmission and signaling parameters you desire. Valid values are **1–18**. Default is **1**.
- **Enhanced 64xx/84xx Display Character Set** — Enter **y** to use enhanced font sets for display terminals. Default is **n**.

The next three fields control tone detection on the system:

- **Tone Detection Mode** — Enter a code (**1** through **5**) to specify the type of tone detection used on a TN420B (or later) tone-detection circuit pack. Default is **1**.

The codes have the following connotations:

1. Precise Italian tone detection algorithm
2. Precise Australian tone detection algorithm

3. Precise UK tone detection algorithm
  4. Imprecise normal broadband filter algorithm (valid with TN420C or later Tone Detector circuit pack)
  5. Imprecise wideband filter algorithm (valid with TN420C or later Tone Detector circuit pack)
- **Dial Tone Validation Timer** — Enter the number of milliseconds (0 through 6375 in increments of 25) that the dial tone validation routine will use to sample transmissions. This field appears only when `Tone Detection Mode` is equal to 4 or 5. (Valid with TN420C or later Tone Detector circuit pack.) Default is 600.
  - **Interdigit Pause** — Enter **short** (5 to 30ms) or **long** (20 to 40ms) to specify the maximum length of the inter-digit pause. Breaks lasting less than this range will be bridged or ignored. (Valid with TN420C or later Tone Detector circuit pack.) Default is **short**.

Pages 2 through 7 of the form

Page 2 of 7

| Tone Name | SYSTEM PARAMETERS COUNTRY-OPTIONS |              |                        |
|-----------|-----------------------------------|--------------|------------------------|
| Cadence   | Tone                              |              |                        |
| Step      | (Frequency/Level)                 |              |                        |
| busy_____ | 1:                                | 440/-17.25__ | Duration (msec): 200__ |
|           | 2:                                | silence_____ | Duration (msec): 200__ |
|           | 3:                                | 440/-17.25__ | Duration (msec): 200__ |
|           | 4:                                | silence_____ | Duration (msec): 200__ |
|           | 5:                                | 440/-17.25__ | Duration (msec): 200__ |
|           | 6:                                | goto_____    | step: 3_               |
|           | 7:                                | _____        |                        |
|           | 8:                                | _____        |                        |
|           | 9:                                | _____        |                        |
|           | 10:                               | _____        |                        |
|           | 11:                               | _____        |                        |
|           | 12:                               | _____        |                        |
|           | 13:                               | _____        |                        |
|           | 14:                               | _____        |                        |
|           | 15:                               | _____        |                        |

Screen 5-136. System Parameters Country-Options form (page 2 of 7)

- **Tone Name** — Enter one of the keywords below to indicate which of the individually administrable tones this screen modifies. This field (with its associated `Tone (Frequency/Level)`, `Duration`, and `Step` fields) is meaningful only if the system tone detector is a TN780, vintage 4 or a TN2182. If this field is blank, all entries in the corresponding `Frequency` and `Duration` fields are ignored. Default is blank.

Acceptable keywords are:

- 1-call-wait
  - 2-call-wait
  - 3-call-wait
  - busy
  - call-wait-ringback
  - conference
  - confirmation
  - disable-dial
  - hold
  - intercept
  - intrusion
  - PBX-dial
  - recall-dial
  - reorder
  - rep-confirmation
  - ringback
  - secondary-dial
- **Cadence Step** — This is a display-only field that identifies the number (1 through 15) of each tone cadence step.
  - **Tone (Frequency/Level)** — Enter **silence**, **goto**, or a set of values to specify the frequency and level of the tone. An entry of **silence** means no tone; an entry of **goto** means to repeat all or part of the sequence, beginning at the specified cadence step. A final step of **silence** with an infinite duration will be added internally to any tone sequence that does not end in a **goto**. Default is blank.

In addition to **silence** and **goto**, the following is a list of acceptable numeric value sets for the tone field:

- 350/-17.25
- 350+425/-4.0
- 350+440/-13.75
- 375+425/-15.0
- 404/-11.0
- 404/-16.0
- 404+425/-11.0
- 404+450/-11.0

5 Basic Forms

System Parameters Country-Options

Page 5-275

- 425/-4.0
- 425/-11.0
- 425/-17.25
- 440/-17.25
- 440+480/-19.0
- 480/-17.25
- 480+620/-24.0
- 525/-11.0
- 620/-17.25
- 697/-8.5
- 770/-8.5
- 852/-8.5
- 941/-8.5
- 1000/0.0
- 1000/+3.0
- 1004/0.0
- 1004/-16.0
- 1209/-7.5
- 1336/-7.5
- 1400/-11.0
- 1477/-7.5
- 1633/-7.5
- 2025/-12.1
- 2100/-12.1
- 2225/-12.1
- 2804/-16.0
- goto
- silence

- **Duration (msec)** — Enter blanks or a value between **50** through **12750**, in increments of 50, to describe the duration of each administered tone. There is one dynamic Duration field associated with each of the 15 Tone (Frequency/Level) fields on each screen page. Initially, when Tone is blank, this field does not appear. However, when a non-blank value other than **goto** is entered in a Tone field, the associated Duration field appears, and must be used to specify the duration (in milliseconds) of the specified tone. Default is blank.

- **Step** — Enter blanks or a Cadence Step (**1** through **14**) beginning the repeated sequence for a "goto" entry. There is one dynamic Step field associated with each of the 15 Tone (Frequency/Level) fields shown on a screen page. Initially, when Tone is blank, this field does not appear. However, when "goto" is entered in a Tone field, the associated Step field appears, and must be used to specify the cadence step to begin repeating from. Default is blank.



## System Parameters Customer-Options

This form sets optional, system-wide parameters. An authorized Lucent Technologies representative sets these parameters for you. ISDN trunks support QSIG Multivendor Connectivity, while ISDN-BRI supports QSIG.

### Administration commands

Use the following commands to administer this form.

| Action  | Object                             | Qualifier <sup>1</sup>  |
|---------|------------------------------------|-------------------------|
| change  | system-parameters customer-options | —                       |
| display | system-parameters customer-options | ['print' or 'schedule'] |

1. Brackets [ ] indicate the qualifier is optional. Single quotes ( ' ) indicate the text inside the quote must be entered exactly as shown or an abbreviated form of the word can be entered.

### Form instructions

#### Page 1 of the form

```

                                Page 1 of 5
                                OPTIONAL FEATURES

                                G3 Version: V6                    Maximum Ports: 300

Abbreviated Dialing Enhanced List? n                CAS Main? n
    Access Security Gateway? n          Cvg Of Calls Redirected Off-net? n
    Analog Trunk Incoming Call ID? n    DCS (Basic)? n
A/D Grp/Sys List Dialing Start at 01? n            DCS Call Coverage? n
Answer Supervision by Call Classifier? n          DCS with Rerouting? n
    ARS? y                                DEFINITY Network Admin? n
    ARS/AAR Partitioning? y              DS1 MSP? n
    ASAI Interface? n                    Emergency Access to Attendant? y
    ASAI Proprietary Adjunct Links? n    Extended Cvg/Fwd Admin? n
    Async. Transfer Mode (ATM) PNC? n    External Device Alarm Admin? n
    Async. Transfer Mode (ATM) Trunking? n Flexible Billing? n
    ATMS? n                              Forced Entry of Account Codes? n

    Audible Message Waiting? n          Global Call Classification? n
    Authorization Codes? n              Hospitality (Basic)? y
    CAS Branch? n                      Hospitality (G3V3 Enhancements)? n
    
```

- **G3 Version** — Identifies the version of DEFINITY ECS being used. (V1.1, V2, V3, V4, V5, V6 per contract)
- **Maximum Ports** — Number of ports active, per contract.
- **Abbreviated Dialing Enhanced List** — Provides the capability to store and retrieve dialing lists that simplify or eliminate dialing. You dial an abbreviated code or depress an assigned button. The stored entries are organized in number lists. There are three types of number lists: personal, group, and enhanced.
- **Access Security Gateway** — Provides an additional level of security for remote access.
- **A/D Grp/Sys List Dialing Start at 01** — Allows you to number Abbreviated Dialing group or system lists like the DEFINITY G2 system.
- **Analog Trunk Incoming Call ID** — Displays only if **G3 Version** is **V6** or later. This field displays the name and number of an incoming call. Valid entries are **y** and **n** (default).
- **Answer Supervision by Call Classifier** — Set this field to **y** if the system contains a call-classifier circuit pack. This circuit pack detects tones and voice-frequency signals on the line and determines whether a call has been answered.
- **ARS** — Provides access to public and private communications networks. Long-distance calls can be routed over the best available and most economical routes. Provides partitioning of ARS routing patterns.
- **ARS/AAR Partitioning** — Provides the ability to partition AAR and ARS into 8 user groups within a single DEFINITY ECS. Can establish individual routing treatment for each group.
- **ASAI Interface** — Provides linkage between DEFINITY ECS and adjuncts. CallVisor ASAI improves the call handling efficiency of ACD agents and other system users by allowing an adjunct to monitor, initiate, control, and terminate calls on the switch.
- **ASAI Proprietary Adjunct Links** — Provides linkage between DEFINITY ECS and adjuncts.
- **Asynch. Transfer Mode (ATM) PNC** — Set this field to **y** to enable port network connectivity (PNC). With this configuration, the processor port network (PPN) is to be connected to expansion port networks (EPNs) via an ATM switch.

ATM PNC can be enabled (this field accepts a **y**) only if:

- the **G3 Version** field is set to **V6**
- all prior fiber-link administration has been removed
- all “switch-node” and “dup-switch-node” carrier types have been removed

Once ATM PNC is enabled, it can be disabled (this field accepts an **n**) only if all atm pnc connections have been removed.

- **Asynch. Transfer Mode (ATM) Trunking** — Set this field to **y** to enable circuit emulation service (CES). With this configuration, multiple ISDN-PRI T1 or E1 trunks can be emulated on one ATM pipe. A **y** is accepted only if the G3 Version field is set to **V6** and the ISDN-PRI field is set to **y**.
- **ATMS** — Provides for voice and data trunk facilities to be measured for satisfactory transmission performance.
- **Audible Message Waiting** — Provides audible message waiting.
- **Authorization Codes** — Permits you to selectively specify levels of calling privileges that override in-place restrictions. In addition to facilities access, authorization codes are used for unique identification for billing security purposes. Authorization codes can be 4-to-7 digits.
- **CAS Branch** — Provides Centralized Attendant Service - Branch. See CAS Main for more information.
- **CAS Main** — Provides multi-location switch customers served by separate switching vehicles to concentrate attendant positions at a single main DEFINITY ECS location. The main DEFINITY ECS is served by an attendant queue that collects calls from all locations (main and branch). Each branch location switches all of its incoming calls to the centralized attendant positions over release link trunks (RLTs). The calls are then extended back to the requested extension at the branch PBX over the same RLT. When the call is answered, the trunks to the main switch are dropped and can be used for another call.
- **Cvg Of Calls Redirected Off-net** — Provides basic telecommuting capability for Coverage of Calls Redirected Off-Net.
- **DCS (Basic)** — Provides transparent operation of selected features across a Distributed Communications System (DCS). Users on one switch can use features located on another switch. Includes 4- and 5-digit uniform dialing and 1–4 digit steering. To invoke DCS with Rerouting, enter **y**.
- **DCS Call Coverage** — Provides DCS-based transparency of the call coverage feature across a DCS network of switches.
- **DCS with Rerouting** — Provides for rerouting calls transferred among DCS nodes, enabling rerouting of the call for more effective use of facilities. Valid entries are **y** and **n** (default). To set value to **y**, enable ISDN-PRI (on page 2) and DCS (Basic).
- **DEFINITY G3 Network Admin** — Indicates the switch is accessible by DEFINITY Network Administration. Valid entries are **y** and **n** (default).
- **DS1 MSP** — Provides the ability to change fields on DS1 circuit pack form without removing the related translations of all trunks from the trunk group.
- **Emergency Access to Attendant** — Provides for emergency calls to be placed to an attendant. These calls can be placed automatically by DEFINITY ECS or dialed by users.

- **Extended Cvg/Fwd Admin** — Provides basic telecommuting package capability for Extended User Administration of Redirected Calls.
- **External Device Alarm Admin** — Provides for analog line ports to be used for external alarm interfaces. Allows identification of port location, adjunct associated with port location, and the alarm level to report.
- **Flexible Billing** — Provides an internationally accepted standard interface for end-to-end digital connectivity. Used with a T1 interface and supports twenty-three 64-KBPS voice or data B-Channels and one 64-Kbps signaling D Channel for total bandwidth of 1.544 Mbps.
- **Forced Entry of Account Codes** — Allows system administration to force account users to enter account codes based on user or trunk class of restriction, or by an option on the Toll Analysis table. FEAC provides an easy method of allocating the costs of specific calls to the correct project, department, etc. Enter account code length up to 15 digits that appears on the CDR report for applicable calls.
- **Global Call Classification** — Provides call classification outside of North America. Listens for tones and classifies tones detected. Required for Call Coverage Off Net and Outgoing Call Management.
- **Hospitality (Basic)** — Provides access to basic features including: Attendant Crisis Alert, Attendant Room Status, Automatic Wakeup, Do Not Disturb, Names Registration, Single-Digit Dialing, and Mixed Station Numbering.
- **Hospitality (G3R5 Enhancements)** — Software required for Property Management System and Automatic Wakeup. Property Management System Interface activates Forward PMS Messages to INTUITY Lodging and PMS Protocol Mode (transmit in ASCII mode). Usage Note: standard hospitality features are included in basic system software.

Page 2 of the form

Page 2 of 5

OPTIONAL FEATURES

|   |                                  |
|---|----------------------------------|
| ISDN-BRI Trunks? n                          | Restrict Call Forward Off Net? n |
| ISDN-PRI? n                                 | Secondary Data Module? y         |
| ISDN-PRI over PACCON? n                     | Station and Trunk MSP? n         |
| Malicious Call Trace? n                     | Tenant Partitioning? n           |
| Mode Code Interface? n                      | Terminal Trans. Init. (TTI)? n   |
| Multifrequency Signaling? y                 | Time of Day Routing? n           |
| Multimedia Appl. Server Interface (MASI)? n | Uniform Dialing Plan? n          |
| Multimedia Call Handling (Basic)? n         | Usage Allocation Enhancements? n |
| Multimedia Call Handling (Enhanced)? n      |                                  |
| Personal Station Access (PSA)? n            | Wideband Switching? n            |
| PNC Duplicaton? n                           | Wireless? n                      |
| Processor and System MSP? n                 |                                  |
| Private Networking?n                        |                                  |

Screen 5-138. System Parameters, Customer Options form (page 2 of 5)

- **ISDN-BRI Trunks** — Provides the capability to add ISDN-BRI trunks to the switch. The ISDN-BRI Trunk circuit pack form is accessible only if this option is **y**. If **n**, the ISDN-BRI Trunk circuit pack form is not accessible even if ISDN-PRI is **y**. If enabled, can add isdn trunk groups and the following forms are accessible:
  - network-facilities
  - private-numbering
  - public-unknown-numbering
- **ISDN-PRI** — Provides Integrated Services Digital Network (ISDN-PRI) software for either a switch-hardware platform migration only or a switch-hardware platform migration in combination with a software version upgrade.
- **ISDN-PRI over PACCON** — Same as ISDN-PRI.
- **Malicious Call Trace** — Provides ability to retrieve certain information related to a malicious call.
- **Mode Code Interface** — Allows you to use the Mode Code Voice Mail System Interface to connect the switch over a DTMF interface to INTUITY AUDIX or other vendors' voice mail systems.
- **Multifrequency Signaling** — Provides for a form of number signaling used between the switch and the central office. Default is **y**.

- **Multimedia Appl. Server Interface (MASI)** — Allows users of the Multimedia Communications Exchange (MMCX) to take advantage of certain DEFINITY ECS telephony features.
- **Multimedia Call Handling (Basic)** — Allows administration of desktop video-conferencing systems as data modules associated with DEFINITY ECS voice stations in a multimedia complex. Users can dial one number to reach either endpoint (voice or data) in the complex.
- **Multimedia Call Handling (Enhanced)** — Allows a multifunction voice terminal to control a multimedia call like a standard voice call.
- **Personal Station Access (PSA)** — Provides basic telecommuting package capability for Personal Station Access.
- **PNC Duplication** — Enter **y** to enable PNC duplication for the critical reliability configuration with port network connectivity. When upgrading from high to critical reliability, one of the two duplicated PNC connections (PPN-to-ATM or PPN-to-CSS) must be removed before PNC duplication can be enabled.
- **Processor and System MSP** — Provides for maintaining processor and system circuit packs.
- **Private Networking** — Upgrades PNA or ETN software RTU purchased with earlier systems.
- **Restrict Call Forward Off Net** — The system can monitor the disposition of an off-call and, if it detects busy, bring the call back for further processing, including call coverage.
- **Secondary Data Module** — Provides ability to use any data module as a secondary data module.
- **Station and Trunk MSP** — Provides for maintaining station and trunk circuit packs.
- **Tenant Partitioning** — Provides for partitioning of attendant groups and/or stations and trunk groups. Typically this is used for multiple tenants in a building or multiple departments within a company or organization.
- **Terminal Trans. Init. (TTI)** — Allows administrators of Terminal Translation Initialization (TTI) to merge an Administered Without Hardware (AWOH) station to a valid port by dialing a system-wide TTI security code and the extension from a terminal connected to that port.
- **Time of Day Routing** — Provides AAR and ARS routing of calls based on the time of day and day of the week. You can take advantage of lower calling rates during specific times.
- **Uniform Dialing Plan** — Provides 4- or 5-digit Uniform Dial Plan (UDP) and 1-4 digit steering. Also allows you to use Extended Trunk Access and Extension Number Portability features.
- **Usage Allocation Enhancements** — Provides for assigning ISDN-PRI or ISDN-BRI Services/Features for Usage Allocation Plans. `ISDN-PRI` or `ISDN-BRI Trunks` must be enabled before using this enhancement.

- **Wideband Switching** — Provides wideband data software for switching video or high-speed data. You can aggregate DSO channels up to the capacity of the span. Wideband supports H0, H11, and H12 standards, where applicable, as well as customer-defined data rates.
- **Wireless** — Provides right to use for wireless applications in certain Network Systems sales. You may purchase it from Lucent Technologies Network Wireless Systems.

Page 3 of the form

Page 3 of 5

CALL CENTER OPTIONAL FEATURES

Logged-In ACD Agents: 150

|  |                                      |
|--|--------------------------------------|
| ACD? n                                 | Service Observing (Basic)? y         |
| BCMS (Basic)? n                        | Service Observing (Remote/By FAC)? n |
| BCMS/VuStats LoginIDs? n               | Service Observing (VDNs)? n          |
| BCMS/VuStats Service Level? n          | Timed ACW? n                         |
| Call Work Codes? n                     | Vectoring (Basic)? n                 |
| CentreVu Advocate? n                   | Vectoring (Prompting)? n             |
| DTMF Feedback Signals For VRU? n       | Vectoring (G3V4 Enhanced)? n         |
| Expert Agent Selection (EAS)? n        | Vectoring (ANI/II-Digits Routing)? n |
| EAS-PHD? n                             | Vectoring (G3V4 Advanced Routing)? n |
| Forced ACD Calls? n                    | Vectoring (CINFO)? n                 |
| Lookahead Interflow (LAI)? n           | Vectoring (Best Service Routing)? n  |
| Multiple Call Handling (On Request)? n | VDN of Origin Announcement? n        |
| Multiple Call Handling (Forced)? n     | VDN Return Destination? n            |
| PASTE (Display PBX Data on Phone)? n   | VuStats? n                           |
| Reason Codes? n                        | VuStats (G3V4 Enhanced)? n           |

Screen 5-139. Call Center Optional Features form (page 3 of 5)

- **Logged-In ACD Agents** — Number of ACD Agents contracted for. Use this field to limit the number of logged-in ACD agents to a number no more than the maximum supported by the system hunt-group-member capacity of the hardware configuration.

The limit applies to ACD agents on ACD and EAS calls. Auto-Available Split (AAS) agent ports are counted when they are assigned. AAS split or skill members are also counted. If the port for an AAS split/skill member is logged out, (for example, when a ringing call is redirected) the logged-in agent count is not updated. These counts are updated only during administration.

- **ACD** — Provides the software required for the Call Center Basic, Plus, Deluxe, and Elite features by all call center features for up to the number of agents specified. Automatic Call Distribution (ACD) automatically distributes incoming calls to specified splits or skills.

- **BCMS (Basic)** — Provides real-time and historical reports about agent, ACD split, Vector Directory Number (VDN) and trunk group activity.
- **BCMS/VuStats LoginIDs** — Allows you to administer valid agent login IDs to monitor call activity by agent. This feature can be used when EAS is not optioned, or in addition to EAS login IDs. When this field is **y**, both BCMS and CMS use the same login ID for an agent.
- **BCMS/VuStats Service Level** — Allows you to set up hunt groups or Vector Directory Numbers (VDNs) with an acceptable service level. An acceptable service level defines the number of seconds within which a call must be answered to be considered acceptable.
- **Call Work Codes** — Allows agents to enter digits for an ACD call to record customer-defined events such as account codes or social security numbers.
- **CentreVu<sup>®</sup> Advocate**— Software that provides an integrated set of advanced features to optimize call center performance. For information on CentreVu<sup>®</sup> Advocate, contact your Account Executive.
- **DTMF Feedback Signals For VRU** — Provides support for the use of C and D Tones to VRUs.
- **EAS-PHD** — Increases the number of skills an agent can log in to from four to 20. Increases the number of agent skill preference levels from two to 16.
- **Expert Agent Selection (EAS)** — Provides skills-based routing of calls to the best-qualified agent.
- **Forced ACD Calls** — See *Multiple Call Handling*.
- **Lookahead Interflow (LAI)** — Provides Look-Ahead Interflow to balance the load of ACD calls across multiple locations.
- **Multiple Call Handling (On Request)** — Allows agents to request additional calls when active on a call.
- **Multiple Call Handling (Forced)** — Forces an agent to be interrupted with an additional ACD call while active on an ACD call. Splits or skills can be one forced, one per skill, or many forced.
- **PASTE (Display PBX Data on Phone)** — Provides an interface between the display of a DCP telephone set and PC-based applications.
- **Reason Codes** — Allows agents to enter a numeric code that describes their reason for entering the AUX work state or for logging out of the system.
- **Service Observing (Basic)** — Allows a specified user to observe an in-progress call on a listen-only or listen-and-talk basis.
- **Service Observing (Remote/By FAC)** — Allows users to service observe calls from a remote location or a local station using this feature's access codes.



- **Service Observing (VDNs)** — Provides the option of observing and/or monitoring another user's calls.
- **Timed ACW** — Places an auto-in agent in ACW for an administered length of time after completion of the currently active ACD call.
- **Vectoring (Basic)** — Provides basic call vectoring capability.
- **Vectoring (Prompting)** — Allows flexible handling of incoming calls based on information collected from the calling party or from an ISDN-PRI message.
- **Vectoring (G3V4 Enhanced)** — Allows for the use of enhanced comparators, wildcards in digit strings for matching on collected digits and ANI or II-digits, use of Vector Routing Tables, multiple audio/music sources for use with wait-time command and priority level with the oldest-call-wait conditional.
- **Vectoring (ANI/II-Digits Routing)** — Provides for ANI and II-Digits vector routing.
- **Vectoring (G3V4 Advanced Routing)** — Provides for Rolling Average Speed of Answer Routing, Expected Wait Time Routing, and VDN Calls Routing.
- **Vectoring (CINFO)** — Provides the ability to collect ced and cdpd from the network for vector routing. Requires ISDN trunks.
- **Vectoring (Best Service Routing)** — Enables the Best Service Routing™ feature. Through special vector commands, Best Service Routing allows you to compare splits or skills at local and remote locations and queue a call to the resource that will give the caller the best service.
- **VDN of Origin Announcement** — Provides a short voice message to an agent indicating the city of origin of the caller or the service requested by the caller based on the VDN used to process the call.
- **VDN Return Destination** — Allows an incoming trunk call to be placed back in vector processing after all parties, except the originator, drop.
- **VuStats** — Allows you to present BCMS statistics on voice terminal displays.
- **VuStats (G3V4 Enhanced)** — Allows you to use the G3V4 VuStats enhancements including historical data and thresholds.

## Page 4 of the form

Page 4 of 5

QSIG OPTIONAL FEATURES

Basic Call Setup? n  
Basic Supplementary Services? n  
Interworking with DCS? n  
Supplementary Services with Rerouting? n

### Screen 5-140. QSIG Optional Features form (page 4 of 5)

- **Basic Call Setup** — Provides basic QSIG services: basic connectivity and calling line ID number.
- **Basic Supplementary Services** — Provides QSIG Supplementary Services:
  - Name ID.
  - Transit Capabilities; that is, the ability to tandem QSIG information elements.
  - Support of Notification Information Elements for interworking between QSIG and non-QSIG tandemed connections.
  - Call Forwarding (Diversion) by forward switching. No reroute capabilities are provided.
  - Call Transfer by join. No path replacement capabilities are provided.
- **Interworking with DCS** — This field is reserved for future functionality.
- **Supplementary Services with Rerouting** — Provides QSIG Supplementary Services:
  - Name ID.
  - Transit Capabilities; that is, the ability to tandem QSIG information elements.
  - Support of Notification Information Elements for interworking between QSIG and non-QSIG tandemed connections.
  - Call Forwarding (Diversion) by forward switching. In addition, reroute capabilities are provided.
  - Call Transfer by join. In addition, path replacement capabilities are provided.

## Page 5 of the form

```
Page 5 of 5

ASAI CAPABILITY GROUPS

Adjunct Call Control? y
Adjunct Routing? y
Domain Control? y
Event Notification? y
Request Feature? y
Set Value? y

ASAI OPTIONAL FEATURES

Answering Machine Detection? y
Selective Listening? n
Switch Classified Outbound Calls? y
```

Screen 5-141. ASAI Capability Groups form (page 5 of 5)

- **Adjunct Routing** — Allows the associated adjunct to provide adjunct routing information to the switch for incoming calls.
- **Domain Control** — Allows an adjunct to control calls and receive event reports for station sets and to receive login and logout event reports for adjuncts in a given ACD split.
- **Event Notification** — Allows the associated adjunct to request incoming call notification and enables the switch to send event reports about such calls.
- **Request Feature** — Allows the associated adjunct to request features such as change work modes, login, logout, sac, and fwd.
- **Set Value** — Allows the adjunct to request status changes for Message Waiting lamps (that is, control of the on/off state of the lamps) and billing changes for 900-type call within Flexible Billing.



**NOTE:**

To request status changes to flexible billing, set `Flexible Billing` to `y` on page 1 of the System-Parameters Customer-Options form.

For CallVisor ASAI adjuncts, you can assign an alarm severity option to each of the following categories via the **set options** command:

- Major on-board ASAI adjunct alarms
- Major off-board ASAI adjunct alarms
- Minor on-board ASAI adjunct alarms
- Minor off-board ASAI adjunct alarms

See *DEFINITY Enterprise Communications Server Release 6 Maintenance for R6 and later* or *DEFINITY Enterprise Communications Server Release 6 Maintenance for R6vs/si and later* or *DEFINITY Enterprise Communications Server Release 6 Maintenance for R6/csi/si and later* for information on using the `set options` command.

For international Outbound Call Management applications, you may need to complete the System Parameters OCM Call Classification form.

## CallVisor ASAI Optional Features

In addition to ASAI capability groups on the System-Parameters Customer-Options form there are ASAI optional features, which are described below. Except for `Switch Classified Outbound Calls`, all options default to `n`.

- **Answering Machine Detection** — Used by the adjunct for predictive Outbound Call Management.
- **Selective Listening** — Consists of two capabilities, Third Party Listen Disconnect and Third Party Listen Reconnect. Listen Disconnect allows the adjunct to disconnect selected listening paths on an active call. Listen Reconnect allows the adjunct to reconnect disconnected listening paths.
- **Switch Classified Outbound Calls** — Enter either `y` or `n` to enable or disable predictive dialing in the switch.

When you enable the CallVisor ASAI option(s), the following capabilities are automatically enabled, regardless of the groups selected: Value Query (includes Response Continued Capability), Abort, Heart Beat, Restart Procedure, Suspend/Resume Alarm.

### NOTE:

You must logoff and login to effect the permission changes.

## System Parameters OCM Call Classification

This form enters the tone characteristics for your country for Outbound Call Management (OCM) applications. It is not required for United States OCM applications. If you cannot access this form, contact your Lucent Technologies representative.

### Page 1 of the form

Page 1 of 2

SYSTEM PARAMETERS OCM CALL CLASSIFICATION

TONE DETECTION PARAMETERS

Global Classifier Adjustment (dB): \_\_\_\_\_

USA Default Algorithm? n

USA SIT Algorithm? \_\_\_\_\_

### Screen 5-142. System Parameters OCM Call Classification form (page 1 of 2)

Page 2 of 9

SYSTEM PARAMETERS OCM CALL CLASSIFICATION

| Tone Name | Instance | Tone Continuous | Cadence Step | Duration Minimum | Duration Maximum |
|-----------|----------|-----------------|--------------|------------------|------------------|
| _____     | _____    | _____           | 1. on        | _____            | _____            |
|           |          |                 | 2. off       | _____            | _____            |
|           |          |                 | 3. on        | _____            | _____            |
|           |          |                 | 4. off       | _____            | _____            |
|           |          |                 | 5. on        | _____            | _____            |
|           |          |                 | 6. off       | _____            | _____            |
|           |          |                 | 7. on        | _____            | _____            |
|           |          |                 | 8. off       | _____            | _____            |

### Screen 5-143. System Parameters OCM Call Classification form (page 2 of 9)

**Global Classifier Adjustment (dB):** — Enter a number in the range 0 – 15 to specify the dB loss adjustment. Default is 0.

**USA Default Algorithm?** — Enter **y** to use the default United States tone detection set. If you enter **n**, the USA SIT Algorithm? field appears.

**USA SIT Algorithm?** — Enter **y** to use the United States Special Information Tones (SIT) tone characteristics for SIT tone detection.

If you enter **n**, the system treats tones with the administered tone name “intercept” as if they were SIT VACANT, and treats tones with the administered tone name “information” as if they were SIT UNKNOWN.

**Tone Name** — Enter the name of the tone that you are adding or modifying. Possible values are: **busy**, **information**, **intercept**, **reorder**, and **ringback**. This field is required for tone definition outside of the US and Canada.

**Instance** — Enter the instance number of the tone. The instance number distinguishes tones that have the same use but more than one definition of silence and tone-on characteristics. If the system identifies a tone that matches the characteristics defined on more than one page of this form the system applies the tone definition from the earlier page.

**Tone Continuous** — Enter **y** to indicate a continuous tone or **n** to indicate a non-continuous tones. If you enter **y** to indicate a continuous tone, you will not be able to enter data in the duration fields.

**Cadence Step** — The display-only field identifies the number of each tone cadence step, and indicates whether the tone is on or off during this cadence step.

**Duration Minimum** — Specify the lower limit in milliseconds of the tone duration. Enter a value between **75** and **6375** milliseconds in increments of 25.

**Duration Maximum** — Specify the upper limit in milliseconds of the tone duration. Enter a value between **75** and **6375** milliseconds in increments of 25.

 **NOTE:**

Set Feature-Related System Parameters Off-Premises Tone Detect Timeout Interval to its maximum value.

## Telecommuting Access

This form allows the System Administrator to administer the extension which allows remote users to use the feature.

### Administration commands

The table below provides the commands and command syntax for administering the Telecommuting Access form.

| Action  | Object               | Qualifier <sup>1</sup> |
|---------|----------------------|------------------------|
| add     | telecommuting-access |                        |
| change  | telecommuting-access |                        |
| display | telecommuting-access | x[print or schedule]   |
| remove  | telecommuting-access |                        |

1. Brackets [ ] indicate the qualifier is optional.

The List Extension-Type command will show you the extension assigned to the Telecommuting Access feature.

### Form instructions

Make assignments as required for the following fields on the form:

#### Page 1 of the Telecommuting Access form

TELECOMMUTING ACCESS

Telecommuting Access Extension: \_\_\_\_\_

#### Screen 5-144. Telecommuting Access — Default form (page 1)

**Telecommuting Access Extension** — The default for this field is blank. That means that no extension is assigned and that no one can use the Telecommuting Access feature. To allow remote access to the Telecommuting Access feature only, enter an extension that conforms to your system's dial plan and which is not assigned to any other system object. If you need to restrict feature use, enter blanks.

## Tenant

---

This form defines tenants to the system. Page one of this form requires that you provide tenant group information and allows you to provide TAAS alert and night destination information. Page 2 of this form lets you establish calling permission from this tenant to all other tenants; this tenant can also call itself.

### Administration commands

---

You can use the change and display commands to administer the Tenant Partitioning form. The syntax for executing these commands is provided below:

| Action  | Object | Qualifier <sup>1</sup> |
|---------|--------|------------------------|
| change  | tenant | x                      |
| display | tenant | x[print or schedule]   |

1. Brackets [ ] indicate the qualifier is optional.

### Form instructions

---

Make assignments as required for the following fields on each page of the form:

#### Page 1 of the Tenant form

Tenant 18

Tenant Description: \_\_\_\_\_

Attendant Group: 1

Ext Alert Port (TAAS): \_\_\_\_\_ Ext Alert (TAAS) Extension: \_\_\_\_\*

Night Destination: \_\_\_\_\_

Music Source: 1

#### Screen 5-145. Tenant — Default form (Tenant 18) (page 1)

**Tenant** — This is a display only field. It contains the tenant number that you entered on the command line.



**Tenant Description** — You can provide a description of up to 40 characters of alpha-numeric information. You may leave the description field blank, but future administration will be easier if you provide descriptive information.

**Attendant Group** — You must enter this information which relates a tenant to an attendant group. See *DEFINITY Enterprise Communications Server Release 6 System Description Pocket Reference*, for your system's range of allowable attendant group numbers. Default is 1.

 **NOTE:**

The default for the system is that all attendant groups exist. However, the attendant group will be empty if no consoles are assigned to it.

**Ext Alert Port (TAAS)** — Enter TAAS alert port information, if any. Enter the port number or **X**. The circuit pack must be installed and defined to the system before you can refer to it here. The port type and the object type must be consistent, and the port can be assigned to only one tenant. The port information for this 7 character field is constructed as follows:

| Characters | Meaning        | Value         |
|------------|----------------|---------------|
| 1-2        | Cabinet Number | 01 through 03 |
| 3          | Carrier        | A through E   |
| 4-5        | Slot Number    | 00 through 20 |
| 6-7        | Circuit Number | 01 through 31 |

**Ext Alert (TAAS) Extension** — This field appears only if you have entered an **X** in `Ext Alert Port (TAAS)`. You must enter a valid, numeric extension number that has not been previously assigned. If you have specified an **X** in `Ext Alert Port (TAAS)`, you must enter extension information in this field.

**Night Destination** — Enter the night service station extension, if you want night service for this tenant. Enter a valid, numeric station extension number. The extension number must have already been defined to the system.

**Music Source** — Enter the music/tone source for the partition. Default is 1.

### Page 2 of the Tenant form

```
Tenant 18

CALLING PERMISSION (Enter y to grant permission to call specified Tenant)

1? y   11? n   21? n   31? n   41? n   51? n   61? n   71? n   81? n   91? n
2? n   12? n   22? n   32? n   42? n   52? n   62? n   72? n   82? n   92? n
3? n   13? n   23? n   33? n   43? n   53? n   63? n   73? n   83? n   93? n
4? n   14? n   24? n   34? n   44? n   54? n   64? n   74? n   84? n   94? n
5? n   15? n   25? n   35? n   45? n   55? n   65? n   75? n   85? n   95? n
6? n   16? n   26? n   36? n   46? n   56? n   66? n   76? n   86? n   96? n
7? n   17? n   27? n   37? n   47? n   57? n   67? n   77? n   87? n   97? n
8? n   18? y   28? n   38? n   48? n   58? n   68? n   78? n   88? n   98? n
9? n   19? n   29? n   39? n   49? n   59? n   69? n   79? n   89? n   99? n
10? n  20? n   30? n   40? n   50? n   60? n   70? n   80? n   90? n  100? n
```

Screen 5-146. Tenant — Default Partition form (Tenant 18 - R5r and later) (page 2)

```
Tenant 18

CALLING PERMISSION (Enter y to grant permission to call specified Tenant)

1? y   11? n
2? n   12? n
3? n   13? n
4? n   14? n
5? n   15? n
6? n   16? n
7? n   17? n
8? n   18? y
9? n   19? n
10? n  20? n
```

Screen 5-147. Tenant — Default form (Tenant 18 - R5vs/si and later) (page 2)

**Tenant** — This is a display only field. It contains the tenant number that you entered on the command line.

Enter **y** to establish calling permission between the tenant number that you entered on the command line and any other tenant. Enter **n** to turn off calling permission. System default allows each tenant to call only itself and Tenant 1; default for all other tenants is **n**.

## Terminating Extension Group

---

This form defines Terminating Extension Groups (TEGs). Any voice terminal can be assigned as a TEG member; however, only a multi-appearance voice terminal can be assigned a TEG button with associated status lamp. The TEG button allows the terminal user to select a TEG call appearance for answering or for bridging onto an existing call.

The TEG members are assigned on an extension number basis. Call reception restrictions applicable to the group are specified by the group class of restriction (COR). The group COR takes precedence over an individual member's COR. The members could all be termination restricted but still receive calls if the group is not restricted.

The system allows for as many as 32 TEGs with up to 4 members each. An extension number can be assigned to more than one TEG but can have only one appearance of each group.

### Administration commands

---

Use the following commands to administer this form. In some cases, just the most commonly used commands are shown. See [Appendix B, "Administration Commands"](#), for a complete listing of all administration commands, the command structure, and the use of abbreviated command words when entering a command.

| Action  | Object         | Qualifier <sup>1</sup>   |
|---------|----------------|--|
| add     | term-ext-group | 1-32 (or 'next')   |
| change  | term-ext-group | 1-32   |
| display | term-ext-group | 1-32 ['print' or 'schedule']   |
| list    | term-ext-group | [1-32]['number' x]['to-number' x]['name' x]['ext' x]<br>['to-ext' x]['count' n]['print' or 'schedule'] |
| remove  | term-ext-group | 1-32   |

---

1. Brackets [ ] indicate the qualifier is optional. Single quotes ( ' ' ) indicate the text inside the quote must be entered exactly as shown or an abbreviated form of the word can be entered.

## Form instructions

```

Page 1 of 1
TERMINATING EXTENSION GROUP

Group Number: 1              Group Extension:
Group Name: 27 character    Coverage Path:
Security Code:              COR: 1
                            TN: 1
ISDN Caller Disp:          LWC Reception: none
AUDIX Name:                Messaging Server Name:

GROUP MEMBER ASSIGNMENTS

Ext      Name
1: 51001 27 character name sta 51001 3:
2:                               4: 51002 27 character name sta 51002
```

Screen 5-148. Terminating Extension Group form (page 1 of 1)

Make assignments as required for the following fields on the form:

- **Group Number** — Enter a group number from 1 through 32 when completing a paper form. This is a display-only field when the form is accessed using an administration command such as **add** or **change**.
- **Group Extension** — Enter an unused extension number (may not be a VDN extension) consisting of two to five digits (do not leave blank).
- **Group Name** — Enter up to 27 characters to identify the group.
- **Coverage Path** — Enter a number for the call coverage path for this group. (A TEG cannot serve as a coverage point; however, calls to a TEG can redirect to coverage).
- **Security Code** — Enter a 4-digit security code or leave blank. This code is used for the Demand Print feature.
- **COR** — Enter the desired class of restriction (COR) number (**0** through **95**) that reflects the desired restrictions. Default is **1**.
- **TN** — Enter the Tenant Partition number. Default is **1**.
- **ISDN Caller Display** — Enter **grp-name** or **mbr-name** to specify whether the TEG group name or member name (member of TEG where call terminated) will be sent to the originating user. This field is required if ISDN-PRI or ISDN-BRI Trunks is enabled on the System-Parameters Customer-Options form. If ISDN-PRI or ISDN-BRI Trunks is not enabled, leave blank.
- **LWC Reception** — Defines the source for Leave Word Calling (LWC) messages. Enter **audix**, **msa-spe**, or **none**.
- **AUDIX Name** — Only displays for an R5r and later configuration. Name of the AUDIX machine as it appears in the Adjunct Names form.

- **Messaging Server Name** — Only displays for an R5r and later configuration. Name of the server as it appears in the Adjunct Names form.
- **Group Member Assignments — Ext** — Enter the extension number (may not be a VDN extension) for the members of this group.
- **Group Member Assignments — Name** — Make no entry. The name is assigned to the preceding extension number when the TEG member's voice terminal is administered.

## Time of Day Coverage Table

This form allows a user to specify the coverage path to be in effect for a five time and day of the week. The user can specify up to five different lead coverage paths, associated with five different time ranges, for each day of the week. Only one lead coverage path can be in effect at any one time.

### Administration commands

Use the following commands to administer the Time of Day Call Coverage Table.

| Action  | Object               | Qualifier |
|---------|----------------------|-----------|
| add     | coverage time-of-day | 1 to 999  |
| change  | coverage time-of-day | 1 to 999  |
| display | coverage time-of-day | 1 to 999  |
| remove  | coverage time-of-day | 1 to 999  |

### Form instructions

TIME OF DAY COVERAGE TABLE \_\_\_\_

|     | Act<br>Time | CVG<br>PATH | Act<br>Time | CVG<br>PATH | Act<br>Time | CVG<br>PATH | Act<br>Time | CVG<br>PATH | Act<br>Time | CVG<br>PATH |
|-----|-------------|-------------|-------------|-------------|-------------|-------------|-------------|-------------|-------------|-------------|
| Sun | 00:00       | ____        | __:__       | ____        | __:__       | ____        | __:__       | ____        | __:__       | ____        |
| Mon | 00:00       | ____        | __:__       | ____        | __:__       | ____        | __:__       | ____        | __:__       | ____        |
| Tue | 00:00       | ____        | __:__       | ____        | __:__       | ____        | __:__       | ____        | __:__       | ____        |
| Wed | 00:00       | ____        | __:__       | ____        | __:__       | ____        | __:__       | ____        | __:__       | ____        |
| Thu | 00:00       | ____        | __:__       | ____        | __:__       | ____        | __:__       | ____        | __:__       | ____        |
| Fri | 00:00       | ____        | __:__       | ____        | __:__       | ____        | __:__       | ____        | __:__       | ____        |
| Sat | 00:00       | ____        | __:__       | ____        | __:__       | ____        | __:__       | ____        | __:__       | ____        |

Screen 5-149. Time of Day Coverage Table (page 1 of 1)

Make assignments as required for the following fields on the form:

- **Act Time** — Specify the activation time of the lead coverage path administered in the next CVG PATH field. Enter the information in 24-hour time format; valid entries are **00:01** to **23:59** or blank. If there are time gaps in the table, there will be no coverage path in effect during those periods. The first activation time for a day is set to 00:00 and cannot be changed. Activation times for a day must be in ascending order from left to right.
- **CVG Path** — Enter the coverage path number. Valid entries are **1** through **9999** for the R5r and later configurations and **1** through **999** for the R5vs/i and later configurations.

## Toll Analysis

---

### ⇒ NOTE:

The Toll List associated with this form has neither relationship or interaction with the [“ARS Toll Table” on page 8-75](#).

This form associates dialed strings to the System’s Restricted Call List (RCL), Unrestricted Call List (UCL), and Toll List. In addition, dialed strings can be associated with the CDR Forced Entry of Account Codes feature (calls from facilities whose COR is administered to include Forced Entry of Account Codes will be required to include an account code).

### ⇒ NOTE:

To maximize System security, it is recommended that toll calling areas be restricted as much as possible through the use of the RCL (Restricted Call List) and Toll List fields on this form.

## Administration commands

---

Use the following commands to administer the Toll Analysis form.

| Action  | Object                        | Qualifier <sup>1</sup>   |
|---------|-------------------------------|--|
| change  | toll                          | Enter digits between 0-9, ‘x’, or ‘X’ [‘min’ 1-23]                         |
| display | toll                          | Enter digits between 0-9, ‘x’, or ‘X’ [‘min’ 1-23] [‘print’ or ‘schedule’] |
| list    | toll toll-list                | [‘start’ dialed-string] [‘count’ (1-1000)] [‘print’ or ‘schedule’]         |
| list    | toll all                      | [‘start’ dialed-string] [‘count’ (1-1000)] [‘print’ or ‘schedule’]         |
| list    | toll restricted-call          | [‘start’ dialed-string] [‘count’ (1-1000)] [‘print’ or ‘schedule’]         |
| list    | toll unrestricted-call [1-10] | [‘start’ dialed-string] [‘count’ (1-1000)] [‘print’ or ‘schedule’]         |

---

1. Brackets [ ] indicate the qualifier is optional. Single quotes ( ‘ ’ ) indicate the text inside the quote must be entered exactly as shown or an abbreviated form of the word may be entered.

## Form instructions

Page 1 of 1  
Percent Full: \_

| Dialed String | Total |     | TOLL ANALYSIS |           |          | <--Unrestricted Call List--> |   |   |   |   |   |   |   |   |    |
|---------------|-------|-----|---------------|-----------|----------|------------------------------|---|---|---|---|---|---|---|---|----|
|               | Min   | Max | RCL           | Toll List | CDR FEAC | 1                            | 2 | 3 | 4 | 5 | 6 | 7 | 8 | 9 | 10 |
| _____         | ___   | ___ | -             | -         | -        | -                            | - | - | - | - | - | - | - | - | -  |
| _____         | ___   | ___ | -             | -         | -        | -                            | - | - | - | - | - | - | - | - | -  |
| _____         | ___   | ___ | -             | -         | -        | -                            | - | - | - | - | - | - | - | - | -  |
| _____         | ___   | ___ | -             | -         | -        | -                            | - | - | - | - | - | - | - | - | -  |
| _____         | ___   | ___ | -             | -         | -        | -                            | - | - | - | - | - | - | - | - | -  |
| _____         | ___   | ___ | -             | -         | -        | -                            | - | - | - | - | - | - | - | - | -  |
| _____         | ___   | ___ | -             | -         | -        | -                            | - | - | - | - | - | - | - | - | -  |
| _____         | ___   | ___ | -             | -         | -        | -                            | - | - | - | - | - | - | - | - | -  |
| _____         | ___   | ___ | -             | -         | -        | -                            | - | - | - | - | - | - | - | - | -  |
| _____         | ___   | ___ | -             | -         | -        | -                            | - | - | - | - | - | - | - | - | -  |
| _____         | ___   | ___ | -             | -         | -        | -                            | - | - | - | - | - | - | - | - | -  |
| _____         | ___   | ___ | -             | -         | -        | -                            | - | - | - | - | - | - | - | - | -  |
| _____         | ___   | ___ | -             | -         | -        | -                            | - | - | - | - | - | - | - | - | -  |
| _____         | ___   | ___ | -             | -         | -        | -                            | - | - | - | - | - | - | - | - | -  |
| _____         | ___   | ___ | -             | -         | -        | -                            | - | - | - | - | - | - | - | - | -  |
| _____         | ___   | ___ | -             | -         | -        | -                            | - | - | - | - | - | - | - | - | -  |
| _____         | ___   | ___ | -             | -         | -        | -                            | - | - | - | - | - | - | - | - | -  |
| _____         | ___   | ___ | -             | -         | -        | -                            | - | - | - | - | - | - | - | - | -  |
| _____         | ___   | ___ | -             | -         | -        | -                            | - | - | - | - | - | - | - | - | -  |
| _____         | ___   | ___ | -             | -         | -        | -                            | - | - | - | - | - | - | - | - | -  |
| _____         | ___   | ___ | -             | -         | -        | -                            | - | - | - | - | - | - | - | - | -  |
| _____         | ___   | ___ | -             | -         | -        | -                            | - | - | - | - | - | - | - | - | -  |
| _____         | ___   | ___ | -             | -         | -        | -                            | - | - | - | - | - | - | - | - | -  |
| _____         | ___   | ___ | -             | -         | -        | -                            | - | - | - | - | - | - | - | - | -  |
| _____         | ___   | ___ | -             | -         | -        | -                            | - | - | - | - | - | - | - | - | -  |
| _____         | ___   | ___ | -             | -         | -        | -                            | - | - | - | - | - | - | - | - | -  |
| _____         | ___   | ___ | -             | -         | -        | -                            | - | - | - | - | - | - | - | - | -  |
| _____         | ___   | ___ | -             | -         | -        | -                            | - | - | - | - | - | - | - | - | -  |

Screen 5-150. Toll Analysis form

Make assignments as required for the following fields on the form:

- **Percent Full** — This is a 3-character display-only field. The field displays the percentage of the system memory resources being used. A common pool of memory resources is shared between the ARS/AAR Digit Conversion, ARS/AAR Digit Analysis, and Toll Analysis Tables. If the Percent Full display indicates that the common pool of memory resources is in jeopardy of becoming full (100%), perform any of the following to "free-up" resources:

  - Delete unnecessary entries from any of the shared resources tables.
  - Utilize the RHNPA table for 6-digit ARS routing.
  - Reduce dialed string field entries to the shortest possible length that accomplishes the desired function.
  
- **Dialed String** — Enter up to an 18-character dialed digit string. Valid entries include the digits **0** through **9** and the wildcard character **x** or **X**. The wildcard letter **x** or **X** may be used to substitute for any digit in the string. A Dialed String, when entered, must be associated with at least one RCL, UCL, CDR Forced Entry Account Code (CDR FEAC), or Toll List.
  
- **Min** — Enter the minimum number of digits to collect (1 to 18). The user can actually dial up to 23 digits (match is on first 18). Default is blank.
  
- **Max** — Enter the maximum digits to collect. The value must be greater than or equal to the Min value. Default is blank.



- **RCL** — Enter **x** to assign the Dialed String to the RCL. Default is blank. All entries of **x** and their associated dialed strings are referred to as the System's Restricted Call List. The RCL can be assigned to any COR. A call attempt from a facility whose COR is marked as being associated with the RCL and whose dialed string matches a RCL dialed string field will be denied. The caller receives intercept treatment.
- **Toll List** — Enter **x** to assign the Dialed String to the Toll List. Default is blank. All entries of **x** and their associated dialed strings are referred to as the System's Toll List. The Toll List is a list of dialed strings used for toll restriction analysis.

When a user calls from a facility whose COR has a Calling Party Restriction of **all-toll** or **tac-toll**, the System checks the Toll Analysis form for the user's dialed string. If a match occurs and `Toll List` is **x**, the call will be denied unless the string also is associated with an Unrestricted Call List that is also assigned the facility's COR. See ["Class of Restriction" on page 5-72](#) for definitions of the Calling Party Restrictions. Also see the "Unrestricted Call List" field description for additional information about UCLs.



**NOTE:**

Toll analysis can ignore IXC codes and/or the toll prefix to find a match.

[Table 5-5](#) shows the System's default toll list assignments.

**Table 5-5. Default Toll List Assignments**

| Dialed String | Min | Max | Toll List |
|---------------|-----|-----|-----------|
| 0             | 1   | 23  | x         |
| 1             | 4   | 23  | x         |
| 20            | 10  | 10  | x         |
| 21            | 10  | 10  | x         |
| 30            | 10  | 10  | x         |
| 31            | 10  | 10  | x         |
| 40            | 10  | 10  | x         |
| 41            | 10  | 10  | x         |
| 50            | 10  | 10  | x         |
| 51            | 10  | 10  | x         |
| 60            | 10  | 10  | x         |
| 61            | 10  | 10  | x         |
| 70            | 10  | 10  | x         |
| 71            | 10  | 10  | x         |
| 80            | 10  | 10  | x         |
| 81            | 10  | 10  | x         |
| 90            | 10  | 10  | x         |
| 91            | 10  | 10  | x         |

- **CDR FEAC** — Enter **x** to assign the dialed string to the CDR Forced Entry of Account Code feature. Default is blank. Users who place calls from facilities whose COR is marked as being associated with Forced Entry of Account Codes and whose dialed string matches an CDR FEAC dialed string field will be required to enter an account code before the call will complete.
- **Unrestricted Call List** — Enter **x** in the appropriate field to assign the dialed string to one of the System's Unrestricted Call Lists (UCL). Default is blank for all fields.

**Implementation note**

Entries on the form do not have to be input in a sorted order. Subsequent displays of the form show all entries in a sorted increasing order.

## User Defined Adjunct Names

This form names the AUDIX and Message Server adjuncts.

 **NOTE:**

This form applies to R5r and later configurations only.

### Administration commands

Use the following commands to administer the User Defined Adjunct Names form.

| Action  | Object        |
|---------|---------------|
| change  | adjunct-names |
| display | adjunct-names |

### Form instructions

Page 1 of 1

```
                USER DEFINED ADJUNCT NAMES
AUDIX NAMES          MESSAGING SERVER NAMES
1: _____        1: _____
2: _____        2: _____
3: _____        3: _____
4: _____        4: _____
5: _____        5: _____
6: _____        6: _____
7: _____        7: _____
8: _____
```

#### Screen 5-151. User Defined Adjunct Names form

Make assignments as required in the following fields.

- **AUDIX Names** — Enter the names of the AUDIX adjuncts here. Entries can be alphanumeric and up to 7 characters long.
- **Messaging Server Names** — Enter the names of the Messaging Server adjuncts here. Entries can be alphanumeric and up to 7 characters long.



# Voice Terminal, PC Interface, and Data Module Administration

# 6

This section describes how to administer voice terminals, PC interfaces, and data modules.

[“Voice terminals — general”](#) and [“Data Modules — general”](#) begin with general administration details and descriptions of fields that are common to many of the Station or Data Module forms. If a field is unique to only one or two Station or Data Module forms, the field is described with the appropriate terminal or data module. You can also find a description of the Terminal Parameters form at the beginning of the voice terminals section. This form allows you to adjust the system-level parameters for specific voice terminals.

[“PC Interface”](#) describes the DEFINITY EIA interface and the PC interface.

The voice terminal section includes descriptions of the following terminals:

**Table 6-1. Voice terminal descriptions**

| Terminal type   | Page                 |
|---|----------------------|
| 10-MET, 20-MET, and 30-MET voice terminals  | <a href="#">6-41</a> |
| 500, 2500, K2500, 7101A, 7102A, 7103A, 7104A, 8110, DS1FD, DS1SA, and VRU voice terminals | <a href="#">6-47</a> |
| 510D personal terminal and 515 business communications terminal                           | <a href="#">6-55</a> |
| 6402, 6402D, 6408, 6408+, 6408D, 6408D+, 6416D+, 6424D+ voice terminals                   | <a href="#">6-60</a> |
| 7302H, 7303H, and 7305H MERLIN voice terminals  | <a href="#">6-72</a> |

*Continued on next page*

**Table 6-1. Voice terminal descriptions — *Continued***

| <b>Terminal type</b>  | <b>Page</b>           |
|---|-----------------------|
| 7303S, 7305S, and 7309H voice terminals                               | <a href="#">6-73</a>  |
| 7313H, 7314H, 7315H, 7316H, and 7317H voice terminals                 | <a href="#">6-80</a>  |
| 7401D, 7401+, 7403D, 7404D, 7410D, and 7410+ voice terminals          | <a href="#">6-90</a>  |
| 7405D voice terminals   | <a href="#">6-99</a>  |
| 7406D, 7406+, 7407D, and 7407+ voice terminals                        | <a href="#">6-111</a> |
| 7434D and 7444D voice terminals                                       | <a href="#">6-121</a> |
| 7505D, 7506D, 7507D, 8503D, 8510T, and 8520T ISDN-BRI voice terminals | <a href="#">6-130</a> |
| CALLMASTER II and III voice terminals                                 | <a href="#">6-141</a> |
| CALLMASTER VI voice terminals   | <a href="#">6-147</a> |
| Personal Computer   | <a href="#">6-153</a> |
| Constellation voice/data terminals                                    | <a href="#">6-158</a> |
| MDC9000 and MDW9000 cordless voice terminals                          | <a href="#">6-163</a> |
| CP9530 cordless voice terminals                                       | <a href="#">6-168</a> |
| 8403B, 8405B, 8405B+, and 8410B voice terminals                       | <a href="#">6-172</a> |
| 8405D, 8405D+, 8410D, and 8434D voice terminals                       | <a href="#">6-180</a> |
| 8411B and 8411D voice terminals                                       | <a href="#">6-189</a> |
| World Class Basic Rate Interface terminal                             | <a href="#">6-194</a> |

The data module section includes descriptions of the following data modules:

**Table 6-2. Data module descriptions**

| <b>Data module type</b>         | <b>Page</b>           |
|---------------------------------|-----------------------|
| Announcement data module        | <a href="#">6-233</a> |
| Data line data module           | <a href="#">6-234</a> |
| Processor/trunk data module     | <a href="#">6-243</a> |
| Netcon data module              | <a href="#">6-245</a> |
| Processor interface data module | <a href="#">6-246</a> |
| System port data module         | <a href="#">6-248</a> |
| X.25 data module                | <a href="#">6-249</a> |
| 7500 data module                | <a href="#">6-252</a> |
| World Class BRI data module     | <a href="#">6-255</a> |

## Voice terminals — general

Voice terminals combine the capabilities of both a telephone and computer and have a variety of controlling and monitoring capabilities. Voice terminals provide end-users basic telephone service — placing and answering calls — and the ability to activate or deactivate the advanced features of the system. DEFINITY ECS supports both single-line and multiappearance voice terminals.

A single-line voice terminal can have only one incoming call and one virtual call appearing at the terminal at a time. Multiappearance voice terminals can have up to ten call appearances appearing at the terminal at the same time.

(Multiappearance voice terminals can have more call appearances with bridging and adjuncts.) Several of the terminals supported by DEFINITY ECS can display call progress and status information.

### How to administer voice terminals

You assign each voice terminal to your system by administering a Station form. Each Station form requires that you specify the type of voice terminal in the `TYPE` field; this is how you distinguish between the many different types of voice terminals. Use the following administration commands to access the appropriate Station form.

**Table 6-3. Administration commands**

| Action    | Object  | Qualifier   |
|-----------|---------|---|
| add       | station | xxxxx (extension) or ('next')   |
| change    | station | xxxxx (extension)   |
| display   | station | xxxxx (extension) ['print']   |
| duplicate | station | xxxxx (extension) ['start' (start extension)] ['board' (board addr) or 'x'] ['count' (1-16)] ['one-ep'] |
| list      | station | [x (extension)]['ext' x]['to-ext' x]['port' x]['type' x] ['count' n]['print' or 'schedule']             |
| remove    | station | xxxxx (extension)   |

 **NOTE:**

When administering a system that is comprised of a large number of digital voice terminals, 20- and 30-MET terminals, or hybrid terminals equipped with feature buttons, administer the voice terminals in the following order:

1. Digital voice terminals
2. 20-MET and 30-MET terminals



3. Hybrid terminals equipped with feature buttons
4. All others (such as, analog, hybrids, 10-MET, and so on)

[Table 6-4](#) lists the voice terminals and personal computers that you can administer. See the voice terminal descriptions later in this section for complete instructions on administering each terminal type.

To administer terminals that are not in [Table 6-4](#), use Enhanced Terminal Administration (ETA) and its associated Alias Station form.

**Table 6-4. Voice terminals**

| <b>Terminal type</b>                             | <b>Model</b>   | <b>Administer as</b> |
|--|--|----------------------|
| Multibutton electronic telephone (MET) terminals | 10-button (5 administrable) with or without speakerphone | 10MET                |
|  | 20-button (15 administrable)                             | 20MET                |
|  | 30-button (25 administrable)                             | 30MET                |
| Single-line analog                               | 500  | 500                  |
|  | 2500   | 2500                 |
|  | 2500 w/ Message Waiting Adjunct                          | 2500                 |
|  | 7101A  | 7101A                |
|  | 7102A  | 7101A                |
|  | 7103A Programmable and Original                          | 7103A                |
|  | 7104A  | 7104A                |
|  | 8110   | 8110                 |
|  | DS1FD  | DS1FD                |
|  | 7302H  | 7303S                |
|  | 7303H  | 7303S                |
| Terminals  | 510D   | 510                  |
|  | 515BCT   | 515                  |

*Continued on next page*

Table 6-4. Voice terminals — *Continued*

| Terminal type           | Model                   | Administer as                             |
|-------------------------|-------------------------|---|
| Multiappearance hybrid  | 7303S                   | 7303S, 7313H                              |
|                         | 7305H01B or 7305H02B    | 7305S                                     |
|                         | 7305H03B                | 7305S                                     |
|                         | 7305H04B                | 7305S                                     |
|                         | 7305S <sup>1</sup>      | 7305S, 7316H, 7317H<br>(with opt display) |
|                         | 7309H                   | 7309H, 7313H                              |
|                         | 7313H                   | 7313H                                     |
|                         | 7314H                   | 7314H                                     |
|                         | 7315H                   | 7315H                                     |
|                         | 7316H                   | 7316H                                     |
| 7317H                   | 7317H                   |   |
| Multiappearance digital | 6402                    | 6402                                      |
|                         | 6402D                   | 6402D                                     |
|                         | 6408                    | 6408                                      |
|                         | 6408+                   | 6408+                                     |
|                         | 6408D                   | 6408D                                     |
|                         | 6408D+                  | 6408D+                                    |
|                         | 6416D+                  | 6416D+                                    |
|                         | 6424D+                  | 6424D+                                    |
|                         | XM24 (Expansion module) | XM24 (Expansion module)                   |

*Continued on next page*

**Table 6-4. Voice terminals — *Continued***

| <b>Terminal type</b> | <b>Model</b>                     | <b>Administer as</b> |
|----------------------|----------------------------------|----------------------|
|                      | 7401D                            | 7401D                |
|                      | 7401+                            | 7401+                |
|                      | 7403D                            | 7403D                |
|                      | 7404D                            | 7404D                |
|                      | 7405D                            | 7405D                |
|                      | 7406D                            | 7406D                |
|                      | 7406+                            | 7406+                |
|                      | 7407D                            | 7407D                |
|                      | 7407+                            | 7407+                |
|                      | 7410D                            | 7410D                |
|                      | 7410+                            | 7410+                |
|                      | 7434D                            | 7434D                |
|                      | 7444D                            | 7444D                |
|                      | 8403B                            | 8403B                |
|                      | 8405B                            | 8405B                |
|                      | 8405B+                           | 8405B+               |
|                      | 8405D                            | 8405D                |
|                      | 8405D+                           | 8405D+               |
|                      | 8410B                            | 8410B                |
|                      | 8410D                            | 8410D                |
|                      | 8411B                            | 8411B                |
|                      | 8411D                            | 8411D                |
|                      | 8434D                            | 8434D                |
|                      | CALLMASTER I                     | 602A1                |
|                      | CALLMASTER II,<br>CALLMASTER III | 603A1, 603D1, 603E1  |
|                      | CALLMASTER VI                    | 606A1                |
|                      | IDT1                             | 7403D                |
|                      | IDT2                             | 7406D                |

*Continued on next page*

**Table 6-4. Voice terminals — *Continued***

| <b>Terminal type</b>       | <b>Model</b> | <b>Administer as</b> |
|----------------------------|--------------|----------------------|
| ISDN-BRI station           | —            | asai <sup>2</sup>    |
| ISDN-BRI station           | 7505D        | 7505D                |
|                            | 7506D        | 7506D                |
|                            | 7507D        | 7507D                |
|                            | 8503D        | 8503D                |
|                            | 8510T        | 8510T                |
|                            | 8520T        | 8520T                |
| Personal computer          | 6300/7300    | PC                   |
| (voice/data)               | 6538/9       | Constellation        |
| Test Line                  | ATMS         | 105TL <sup>3</sup>   |
| Key phone system interface | —            | K2500 <sup>4</sup>   |
| ASAI                       |              | ASAI                 |
| ISDN-BRI data module       | 7500         | 7500                 |

1. If administered as 7316H, then Internal Automatic Answer (IAA) works.
2. “asai” is administered as the ISDN-BRI set type in support of an Adjunct Switch Applications Interface (ASAI) link. This interface supports use of CallVisor ASAI and an associated adjunct (such as CONVERSANT speech processor) used with Inbound Call Management.
3. Available without the Automatic Transmission and Measurement System (ATMS) package.
4. K2500 uses the same administration form as the 2500, except it supports rotary or DTMF terminals.

## Terminal Parameters form

---

This form administers system-level parameters and audio levels for the 603 CALLMASTER voice terminals and the 6400-series, 8403, 8405B, 8405B+, 8405D, 8405D+, 8410B, 8410D, 8411B, 8411D, and 8434D terminals.

### NOTE:

Only authorized Lucent Technologies personnel can administer this form.

### Administration commands

---

You can use the following commands to display the Terminal Parameters form. Use the **603/606/302B1** command for the CALLMASTER II/III (603) and CALLMASTER VI (606) voice terminals as well as the 302B1 Attendant Console. Use the **8400** command for the 8400-series voice terminals.

| Action  | Object                            | Qualifier <sup>1</sup>  |
|---------|-----------------------------------|-------------------------|
| display | terminal-parameters 603/606/302B1 | ['print' or 'schedule'] |
| display | terminal-parameters 8400          | ['print' or 'schedule'] |
| display | terminal-parameters 6400          | ['print' or 'schedule'] |

1. Brackets [ ] indicate the qualifier is optional. Single quotes ( ' ' ) indicate the text inside the quote must be entered exactly as shown or an abbreviated form of the word can be entered.

Making a change to this form affects all 603 voice terminals, 606 voice terminals, and 302B1 attendant consoles or all 8400-series voice terminals, depending on whether you are administering the 603/606/302B1 or the 8400-series voice terminals.

A terminal that has not been programmed with the correct parameters may experience incorrect volume levels while a user is on a call or incorrect touchtone levels while the user is placing a call. If you suspect the parameters are incorrect, use the **busyout station/release station** commands to force the currently administered parameters to be sent to the terminal. Use the **status station** command to verify that the download status field indicates the parameters were successfully downloaded.

The switch checks all the 603-, 6400-, and 8400-series terminals each day (during scheduled maintenance) to ensure they are operating with the currently-administered transmission parameters. If the switch detects an

incorrectly-programmed terminal, it automatically attempts to send the correct parameters to the terminal.

**⇒ NOTE:**

Terminals that are off-hook cannot be programmed, and therefore, cannot be corrected until they are on-hook the next time the switch attempts to correct the parameters.

**Form instructions**

---

```

                                8400-TYPE TERMINAL PARAMETERS

Default Parameter Set: __          Customize Parameters? _

OPTIONS*
    Display Mode: _*                DLI Voltage Level: _____*
    Handset Expander Enabled? _*

PRIMARY LEVELS*
    Voice Transmit (dB): _____*    Voice Sidetone (dB): _____*
    Voice Receive (dB): _____*    Touch Tone Sidetone (dB): _____*
    Touch Tone Transmit (dB): _____*

ADJUNCT LEVELS**
    Voice Transmit (dB): _____*    Voice Receive (dB): _____*
    Voice Sidetone (dB): _____*    Touch Tone Sidetone (dB): _____*
```

Screen 6-1. 8400-Series Terminal Parameters form

\* This field appears only if Customize Parameters is **y**.

```

                                603/302B1 TERMINAL PARAMETERS

Default Parameter Set: __          Customize Parameters? _

OPTIONS*
    Display Mode: _*                DLI Voltage Level: _____*

PRIMARY LEVELS*
    Voice Transmit (dB): _____*    Voice Sidetone (dB): _____*
    Voice Receive (dB): _____*    Touch Tone Sidetone (dB): _____*
    Touch Tone Transmit (dB): _____*
```

Screen 6-2. 603/302B1 Terminal Parameters form

6400-TYPE TERMINAL PARAMETERS

Default Parameter Set:1                      Customize Parameters?y

OPTIONS

                  Display Mode:  
 Handset Expander Enabled?  
                   Volume:

PRIMARY LEVELS

                  Voice Transmit (dB):                      Voice Sidetone (dB):  
                   Voice Receive (dB):                      Touch Tone Sidetone (dB):  
                   Touch Tone Transmit (dB):

BUILT-IN SPEAKER LEVELS

                  Voice Transmit (dB):                      Voice Receive (dB):  
                   Touch Tone Sidetone (dB):

6402 BUILT-IN SPEAKER LEVELS

                  Voice Receive (dB):                      Touch Tone Sidetone (dB):

Screen 6-3. 6400 Type Terminal Parameters form

\* This field appears only if Customize Parameters is y.

- **Default Parameter Set** — Determines which default set of terminal options and levels will be used. Currently, five default parameter sets (for the USA, Australia, Italy, Netherlands, and the UK) have been defined. All other country codes will automatically map to one of these sets. Enter the correct country code (1 to 19) for your country.

Country codes are shown in [Table 6-5](#).

Table 6-5. Country Codes

| Country Code | Country Name          |
|--------------|-----------------------|
| 1            | United States, Canada |
| 2            | Australia             |
| 3            | Japan                 |
| 4            | Italy                 |
| 5            | Netherlands           |
| 6            | Singapore             |
| 7            | Mexico                |

*Continued on next page*

Table 6-5. Country Codes — *Continued*

| Country Code | Country Name              |
|--------------|---------------------------|
| 8            | Belgium, Luxembourg       |
| 9            | Saudi Arabia              |
| 10           | United Kingdom            |
| 11           | Spain                     |
| 12           | France                    |
| 13           | Germany, South Africa     |
| 14           | Czech Republic, Slovakia  |
| 15           | Russia (CIS)              |
| 16           | Argentina                 |
| 17           | Greece                    |
| 18           | China                     |
| 19           | Hong Kong                 |
| 20           | Thailand                  |
| 21           | Macedonia                 |
| 22           | Poland                    |
| 23           | Brazil                    |
| etsi         | Europe, New Zealand, etc. |

- **Customize Parameters** — Indicates whether the administrator wishes to change one or more of the default parameters. If this field is **n** (no), the system uses all default parameters associated with the Default Parameter Set. If this field is **y** (yes), the **OPTION** and **LEVEL** fields appear.
- **Display Mode** — Determines how the #) and ~ characters appear on the 603 terminal's display. If this field is set to **1**, the # and ~ do not change. If this field is set to **2**, the 603 terminal displays a # as a British pound sterling symbol and a ~ as a straight overbar. This field only appears if **Customize Parameters** is **y**.
- **DLI Voltage Level** — Determines whether DCP Line Voltage used by the terminals is forced high, for
- ced low, or allowed to automatically adjust. This field only appears if **Customize Parameters** is **y**.



- **Handset Expander Enabled** — Determines whether the terminal will reduce noise on the handset. If the field is **y**, the terminal reduces background noise. This field appears only if `Customize Parameters` is **y**.

### Primary levels

The following fields only appear if `Customize Parameters` is set to **y**. In each case, if the field is blank, the system uses the default setting from the Default Parameter Set. Also, these fields all require the same input; valid entries are from **-44.0** db through **+14.0** db in 0.5 increments (for example, -44.0, -43.5, -43.0 and so on).

- **Voice Transmit (dB)** — Determines the volume of voice outbound from the terminal.
- **Voice Receive (dB)** — Determines the volume of voice inbound to the terminal.
- **Voice Sidetone (dB)** — Determines the volume of voice fed back from the handset voice microphone to the user's ear.
- **Touch Tone Sidetone (dB)** — Determines the touchtone volume fed back from the terminal when a users presses a button.
- **Touch Tone Transmit (dB)** — Determines the touchtone volume fed outbound from the terminal.

### ⇒ NOTE:

You cannot administer all five of the `Primary Level` fields to +14.0 dB. If you attempt to submit the Terminal Parameters form with all Primary Levels set to +14.0 dB, you receive an error message.

### Adjunct levels

The following fields appear only if you are administering 8400-series terminals and if `Customize Parameters` is **y**. In each case, if the field is blank, the system uses the default setting from the Default Parameter Set. Also, these fields all require the same input; valid input is listed in "Primary levels" above.

**Voice Transmit (dB)** — Determines the volume of voice outbound from the adjunct.

**Voice Receive (dB)** — Determines the volume of voice inbound to the adjunct.

**Voice Sidetone (dB)** — Determines the volume of voice fed back from the handset voice microphone to the user's ear.

**Touch Tone Sidetone (dB)** — Determines the touchtone volume fed back from the terminal when a users presses a button.

## Voice-terminal feature button descriptions

[Table 6-6](#) provides descriptions of the feature buttons that you can administer on multiappearance voice terminals. It also lists the administrable software names and recommended button label names. Display buttons support voice terminals equipped with alphanumeric displays.

Depending on the voice terminal type, you may not be able to administer some feature buttons. The voice terminal type descriptions later in this book include listings of the feature buttons that you can administer for each terminal.

**Table 6-6. Voice-terminal feature button descriptions**

| Button name                                    | Button label        | Description   | Maximum                     |
|--|---------------------|---|-----------------------------|
| abr-prog                                       | AbrvDial<br>Program | Abbreviated Dialing Program Mode: allows users to program abbreviated dialing buttons or to store or change numbers in a personal list or group list associated with the station.   | 1 per station               |
| abr-spchar                                     | AbrvDial<br>(char)  | Abbreviated Dialing Special Character: allows users to enter an associated special character [~, ~m (mark), ~p (pause), ~s (suppress), ~w (wait for dial tone), or ~W (wait forever)] when programming an abbreviated dialing list entry. | 1 each per station          |
| abrdg-app <sup>1</sup><br>(Ext: ____)          | (extension)         | Bridged Call Appearance of an Analog Station: allows the user to have an appearance of a single-line voice-terminal extension.  | Depends on station type     |
| abrv-dial <sup>2</sup><br>(List: __<br>DC: __) | AD                  | Abbreviated Dialing: accesses an associated abbreviated dialing list entry and causes the associated stored number to be dialed.  | 1 per AD list per dial code |
| abrv-ring                                      | AR                  | Manually triggers an Abbreviated or Delayed Transition for calls alerting at an extension   |                             |

*Continued on next page*

Table 6-6. Voice-terminal feature button descriptions — *Continued*

| Button name                        | Button label    | Description   | Maximum           |
|------------------------------------|-----------------|---|-------------------|
| ac-alarm                           | AC Alarm        | Administered Connection Alarm Notification: associated status lamp lights when the number of failures for at least one administered connection has equaled the specified threshold.   | 1 per station     |
| aca-halt                           | Auto-Ckt Assure | Automatic Circuit Assurance ( <i>display button</i> ): allows users of display voice terminals to identify trunk malfunctions. The system automatically initiates a referral call to the terminal when a possible failure occurs. The button is used to activate/deactivate referral calls. | 1 per system      |
| account                            | Acct            | Used to enter Call Detail Recording (CDR) account codes. CDR account codes allow you to associate and track calls according to a particular project or account number.  |                   |
| admin                              | Admin           | Allows users to administer specific features on their own stations.   |                   |
| after-call <sup>3</sup>            | After Call Work | After Call Work Mode: used to remove an agent from ACD call distribution in order for the agent to complete ACD-related activities such as forms completion.  | 1 per split group |
| alrt-agchg                         | Alert Agent     | When an agent has had his split/skill hunt group changed while active on a call, this button blinks to notify the agent of the change.  | 1 per station     |
| alt-frl                            | Alt FRL         | Alternate FRL: activates or deactivates Alternate Facility Restriction Level (AFRL).  | 1 per system      |
| assist <sup>3</sup><br>(Group: __) | Assist          | Supervisory Assistance: used by an ACD agent to place a call to a split supervisor.   | 1 per split group |
| asvn-halt                          | asvn-halt       | Authorization Code Security Violation Notification Call: activates or deactivates call referral when a authorization code security violation is detected.   | 1 per system      |

*Continued on next page*

Table 6-6. Voice-terminal feature button descriptions — *Continued*

| Button name                           | Button label                  | Description  | Maximum                         |
|---------------------------------------|-------------------------------|--|---------------------------------|
| atd-qcalls <sup>4</sup>               | AQC                           | Attendant Queue Calls ( <i>display button</i> ): tracks the number of calls in the attendant group's queue and obtains a display of the queue status.  | 1 per station                   |
| atd-qtime <sup>4</sup>                | AQT                           | Attendant Queue Time ( <i>display button</i> ): tracks the calls in the attendant group's queue according to the oldest time a call has been queued, and obtains a display of the queue status.                      | 1 per station                   |
| aut-msg-wt <sup>5</sup><br>(Ext: __)  | Message<br>(name or<br>ext #) | Automatic Message Waiting: associated status lamp automatically lights when an LWC message has been stored in the system for the associated extension (can be a VDN).  | 1 per<br>aut-mst-ext            |
| auto-cback                            | Auto<br>CallBack              | Automatic Call Back: when activated, allows inside user who placed a call to a busy or unanswered voice terminal to be called back automatically when the called voice terminal becomes available to receive a call. | 1 per<br>station                |
| auto-icom <sup>6</sup><br>(Group: __) | Auto (name<br>or ext #)       | Automatic Intercom: places a call to the station associated with the button. The called user receives a unique alerting signal, and a status lamp associated with a Intercom button flashes.                         | 1 per group<br>per dial<br>code |
| auto-in <sup>3</sup><br>(Group: __)   | Auto In                       | Auto-In Mode: allows the user to become automatically available for new ACD calls upon completion of an ACD call.  | 1 per split<br>group            |
| auto-wkup                             | Auto<br>Wakeup                | Automatic Wakeup ( <i>display button</i> ): allows attendants, front-desk users, and guests to request a wakeup call to be placed automatically to a certain extension (may not be a VDN extension) at a later time. | 1 per<br>station                |
| autodial                              | Autodial                      | Allows a user to dial a number that is not part of a stored list.  |                                 |

*Continued on next page*

Table 6-6. Voice-terminal feature button descriptions — *Continued*

| Button name                                      | Button label    | Description  | Maximum                 |
|--|-----------------|--|-------------------------|
| aux-work <sup>3</sup><br>(Group: __)             | Auxiliary Work  | Auxiliary Work Mode: removes agent from ACD call distribution in order to complete non-ACD-related activities.   | 1 per split group       |
| brdg-appr <sup>1</sup><br>(Ext: __<br>button: 1, | (extension)     | Bridged Call Appearance of a Multiappearance Station: provides an appearance of a voice terminal primary extension at the terminal assigned the brdg-appr button. The button tracks and may be used like a call appearance on the tracked station. | Depends on station type |
| btn-view   | Button View     | Button View: allows users to view, on the terminal's display, the contents of any feature button.  |                         |
| busy-ind <sup>7</sup><br>(TAC or Ext)            | Busy            | Station Busy Indication: provides an end-user with a visual indication of the busy or idle status of an extension, trunk group, TEG, hunt group, or loudspeaker paging zone.   | 1 per TAC/Ext           |
| call-appr <sup>1</sup>                           | (extension)     | Call Appearance: originates or receives calls.   | Depends on station type |
| call-disp  | Return Call     | Call Displayed Number ( <i>display button</i> ): automatically initiates a call to the currently displayed number, which may be a part of a leave word calling message or a number retrieved using Integrated Directory.                           | 1 per station           |
| call-fwd   | Call Forwarding | Activates or deactivates Call Forwarding All Calls.  |                         |
| call-park  | Call Park       | Places a current call in the call park state and later used to retrieve the call.  | 1 per station           |
| call-pkup  | Call Pickup     | Picks up a call that is ringing in the users pickup group.   | 1 per station           |
| callr-info                                       | Caller Info     | ( <i>display button</i> ) Used with Call Prompting to allow users to display information collected from the originator.  | 1 per station           |

*Continued on next page*

Table 6-6. Voice-terminal feature button descriptions — *Continued*

| Button name | Button label                | Description  | Maximum       |
|-------------|-----------------------------|--|---------------|
| cas-backup  | CAS Backup                  | Centralized Attendant Service Backup Mode: used to redirect all CAS calls to a backup extension in the local branch if all RLTs are out-of-service or maintenance busy. The associated status lamp indicates if CAS is in the backup mode. | 1 per station |
| cdr1-alm    | CDR 1 Failure               | CDR Alarm: associated status lamp is used to indicate that a failure in the interface to the primary CDR output device has occurred.   | 1 per station |
| cdr2-alm    | CDR 2 Failure               | CDR Alarm: associated status lamp is used to indicate that a failure in the interface to the secondary CDR output device has occurred.   | 1 per station |
| cfwd-bsyda  | Call Forwarding bsyda (Ext) | Activates Call Forward Busy/Don't Answer.  |               |
| check-in    | Check In                    | <i>(display button)</i> Changes the state of the associated guest room to occupied and turn off the outward calling restriction for the guest room's station.  | 1 per station |
| check-out   | Check Out                   | <i>(display button)</i> Changes the state of the associated guest room to vacant and turns on the outward calling restriction for the guest room's station. Also clears (removes) any wake-up request for the station.                     | 1 per station |
| clk-overid  | Clocked Override            | Clocked Manual Override <i>(display button)</i> : used in association with Time of Day Routing to override the routing plan in effect for the activating user. The routing plan is overridden for a specified period of time.              | 1 per station |
| consult     | Consult                     | Used by a covering party, after answering a coverage call, to call the principal (called party) for private consultation.  | 1 per station |

*Continued on next page*

Table 6-6. Voice-terminal feature button descriptions — *Continued*

| Button name                          | Button label       | Description   | Maximum                    |
|--------------------------------------|--------------------|---|----------------------------|
| cov-cback                            | Coverage Callback  | Used by a covering party to leave a message for the principal (called Party) to call the calling party  | 1 per station              |
| cov-msg-rt                           | Covr Msg Retrieve  | Coverage Message Retrieval ( <i>display button</i> ): used to place a covering station into the message retrieval mode for the purposes of retrieving messages for the group                  | 1 per station              |
| cpn-blk                              | CPN Block          | Blocks the sending of the calling party number for a call.  | 1 per station              |
| cpn-unblk                            | CPN Unblock        | Deactivates the blocking for sending the calling party number for a call  | 1 per station              |
| data-ext                             | Data (data ext #)  | Data Extension; used to set up a data call. May be used to pre-indicate a data call or to disconnect a data call. May not be a VDN or ISDN-BRI extension. Not allowed on an ISDN-BRI station. | 1 per data-extension group |
| date-time                            | Date Time          | ( <i>display button</i> ) Displays the current date and time  | 1 per station              |
| delete-msg                           | Delete Message     | ( <i>display button</i> ) Deletes a stored message that is currently on the display.  | 1 per station              |
| dial-icom <sup>8</sup><br>(Grp: ___) | Dial Icom          | Dial Intercom: Accesses the intercom group assigned to the button.  | 1 per group                |
| dir-pkup                             | dir-pkup           | Directed call pickup  |                            |
| directory                            | Integrtd Directory | Directory ( <i>display button</i> ): used to place the station's display in the integrated directory mode.  | 1 per station              |
| disp-chrg                            | Display Charge     | Provides your display terminal with a visual display of accumulated charges on your current telephone call. Used exclusively outside the U.S. and Canada.                                     | 1 per station              |
| disp-norm                            | Local/ Normal      | ( <i>display button</i> ): Toggles between LOCAL display mode (displays time and date) and NORMAL mode (displays call-related data). LED off = LOCAL mode and LED on = NORMAL.                | 1 per station              |

*Continued on next page*

Table 6-6. Voice-terminal feature button descriptions — *Continued*

| Button name        | Button label       | Description  | Maximum       |
|--------------------|--------------------|--|---------------|
| dn-dst             | Do Not Disturb     | Places the user in the do not disturb mode   | 1 per station |
| drop               | Drop               | Allows users to drop calls   |               |
| ds1-alarm          | DS1 (facility)     | DS1 Alarm: associated status lamp lights if an off-circuit pack major, minor, or warning alarm is active on a DS1 circuit pack. Off-board alarms (e.g., loss of signal, slips, misframes) relate to problems on the facility side of the DS1 interface.                          |               |
| exclusion          | Exclusion          | Prevents other users from bridging onto the current call   | 1 per station |
| ext-dn-dst         | Do Not Disturb Ext | Extension — Do Not Disturb ( <i>display button</i> ): used by the attendant console or hotel front desk display terminal to activate do not disturb and assign a corresponding deactivate time to an extension.  | 1 per station |
| flash <sup>9</sup> | Flash              | 1) Allows a station on a trunk call with Trunk Flash to send a Trunk Flash signal to the far end (e.g., Central Office); 2) allows a station on a CAS main call to send a Trunk Flash signal over the connected RLT trunk back to the branch to conference or transfer the call. | 1 per station |
| goto-cover         | Go To Cover        | Go To Coverage: sends a call directly to coverage instead of waiting for the called inside-user to answer.   | 1 per station |
| grp-page           | GrpPg              | Allows users to make announcements to groups of stations by automatically turning on their speakerphones.  |               |
| grp-dn-dst         | Do Not Disturb Grp | Group Do Not Disturb ( <i>display button</i> ): removes a group of users from the do not disturb mode.   | 1 per station |

*Continued on next page*



Table 6-6. Voice-terminal feature button descriptions — *Continued*

| Button name  | Button label                                      | Description  | Maximum                       |
|--|---|--|-------------------------------|
| headset  | Headset   | Signals onhook/offhook state changes to the switch. The green LED is on for offhook state and off (dark) for onhook state.           |                               |
| hunt-ns <sup>10</sup><br>(Grp: ___)                | Hunt Group  | Hunt-Group Night Service: places a hunt-group into night service.  | 3 per hunt group              |
| in-call-id <sup>11</sup><br>(Type: __<br>Grp: ___) | Coverage<br>(group #,<br>type, name,<br>or ext #) | Coverage Incoming Call Identification: identifies the hunt or coverage answer group associated with the current incoming call.       | 1 per group-type<br>per group |
| inspect  | Inspect Mode                                      | ( <i>display button</i> ) Displays the extension of the current ringing call or behind a subsequently-pressed call appearance.       | 1 per station                 |
| int-aut-an   | IntAutoAns  | Internal Auto Answer: conditions any hybrid or digital station to automatically answer incoming internal calls.                      | 1 per station                 |
| last-numb  | LastNumb Dialed                                   | Last Number Dialed: originates a call to the number last dialed by the station.  | 1 per station                 |
| link-alarm <sup>12</sup><br>(link# ___)            | Link Failure<br>(link #)                          | Link Alarm: associated status lamp indicates that a failure has occurred on one of the Processor Interface circuit pack data links.  | 8 per station                 |
| lsvn-halt  | Login SVN   | Login Security Violation Notification: activates or deactivates referral call when a login security violation is detected.           | 1 per system                  |
| lwc-cancel   | Cancel LWC  | Leave Word Calling Cancel: cancels the last leave word calling message originated by the user.                                       | 1 per station                 |
| lwc-lock   | Lock LWC  | Leave Word Calling Lock: locks the message retrieval capability of the display module on the station.                                | 1 per station                 |
| lwc-store  | LWC   | Leave Word Calling Store: leaves a message for the user associated with the last number dialed to return the call to the originator. | 1 per station                 |

*Continued on next page*

Table 6-6. Voice-terminal feature button descriptions — *Continued*

| Button name                            | Button label             | Description  | Maximum           |
|--|--------------------------|--|-------------------|
| major-alm                              | Major Hdwe Failure       | Major Alarm: associated status lamp indicates that a vital system hardware component failed. This type of alarm represents a disruption of overall system performance.                                   | 1 per station     |
| man-msg-wt <sup>13</sup><br>(Ext: ___) | Msg Wait (name or ext #) | Manual Message Waiting: lights a message waiting lamp on the station associated with the button.   | None              |
| man-overid                             | Immediate Override       | Immediate Manual Override ( <i>display button</i> ): used in association with Time of Day Routing to temporarily override the routing plan in effect for the activating user's partitioned group number. | 1 per station     |
| manual-in <sup>3</sup><br>(Group: __)  | Manual In                | Manual-In Mode: prevents the user from becoming available for new ACD calls upon completion of an ACD call by automatically placing the agent in the after call work mode.                               | 1 per split group |
| mct-act                                | MCT Activation           | Malicious Call Trace Activation: sends a message to MCT controller consoles to indicate that a user wants to trace a malicious call.   |                   |
| mct-contr                              | MCTControl               | Malicious Call Trace Control: allows the console to take control of malicious call trace requests. (Must be administered with change-mct-group-extensions)   |                   |
| mf-da-intl                             | Directory Assistance     | Multifrequency Operator International: allows users to call Directory Assistance.  | 1 per station     |
| mf-op-intl                             | CO attendant             | Multifrequency Operator International: allows users to make international calls to the CO attendant.   | 1 per station     |
| mj/mn-alm                              | Major/Minor Hdwe Failure | Minor Alarm: associated status lamp indicates that a system hardware component failed and disrupts service on a limited scale.   | 1 per station     |

*Continued on next page*

Table 6-6. Voice-terminal feature button descriptions — *Continued*

| Button name                            | Button label          | Description  | Maximum       |
|--|-----------------------|--|---------------|
| mm-datacnf                             | MM Datacnf            | Multimedia Data Conference: used to initiate a data collaboration session between multimedia endpoints; requires a button with a lamp. | 1 per station |
| msg-retr                               | Message Retrieve      | Message Retrieval ( <i>display button</i> ): places the station's display into the message retrieval mode.                             | 1 per station |
| mwn-act                                | Message Waiting Act.  | Message Waiting Activation: lights a message waiting lamp on an associated station.  | 1 per station |
| mwn-deact                              | Message Waiting Deact | Message Waiting Deactivation: dims a message waiting lamp on an associated station.  | 1 per station |
| next                                   | Next                  | Next Message ( <i>display button</i> ): steps to the next message when the station's display is in message retrieval mode.             | 1 per station |
| night-serv                             | Night Serv            | Night Service Activation: toggles the system in or out of Night Service mode.  | 1 per station |
| noans-alrt                             | RONA                  | Redirection on No Answer Alert: indicates a Redirection on No Answer timeout has occurred for the split.                               | 1 per split   |
| normal                                 | Normal Mode           | Normal ( <i>display button</i> ): places the station's display into normal call identification mode.                                   | 1 per station |
| per-COline <sup>14</sup><br>(Grp: ___) | CO Line<br>(line #)   | Personal CO Line: allows the user to receive calls directly via a specific trunk.  | 1 per group   |
| pms-alarm                              | PMS Failure           | PMS Alarm: associated status lamp indicates that a failure in the PMS occurred. A major or minor alarm condition raises the alarm.     | 1 per station |
| pr-awu-alm                             | Auto Wakeup Alm       | Automatic Wakeup Printer Alarm: associated status lamp indicates that an automatic wakeup printer interface failure occurred.          | 1 per station |

*Continued on next page*

Table 6-6. Voice-terminal feature button descriptions — *Continued*

| Button name                         | Button label       | Description  | Maximum                      |
|-------------------------------------|--------------------|--|------------------------------|
| pr-pms-alm                          | PMS Ptr Alarm      | PMS Printer Alarm: associated status lamp indicates that a PMS printer interface failure occurred.   | 1 per station                |
| pr-sys-alm                          | Sys Ptr Alarm      | System Printer Alarm: associated status lamp indicates that a system printer (dedicated to Report Scheduler) interface failure occurred.           | 1 per station                |
| print-msgs                          | Print Msgs         | Print Messages: allows users to print messages for any extension by pressing the button and entering the extension and a security code.            | 1 per station                |
| priority                            | Priority Call      | Priority Calling: allows a user to place priority calls or change an existing call to a priority call.   | 1 per station                |
| q-calls <sup>15</sup><br>(Grp: ___) | NQC                | Queue Calls: associated status lamp flashes if a call warning threshold has been reached.  | 1 per hunt group per station |
| q-time <sup>15</sup><br>(Grp: ___)  | OQT                | Queue Time: associated status lamp flashes if a time warning threshold has been reached.   | 1 per hunt group per station |
| release <sup>3</sup>                | Release            | Releases an agent from an ACD call.  | 1 per station                |
| ringer-off                          | Ringer Cutoff      | Ringer-Off: silences the alerting ringer on the station.   | 1 per station                |
| rs-alert                            | System Reset Alert | The associated status lamp lights if a problem escalates beyond a warm start.  | 1 per station                |
| rsvn-halt                           | rsvn-halt          | Remote Access Barrier Code Security Violation Notification Call: activates or deactivates call referral.   | 1 per system                 |
| scroll                              | Scroll             | ( <i>display button</i> ) Selects one of two lines (alternates with each press) of the 16-character LCD display. Only one line displays at a time. | 1 per station                |
| send-calls                          | Send All Calls     | Send All Calls: sends all calls to coverage as soon as they terminate at the station.  |                              |

*Continued on next page*

Table 6-6. Voice-terminal feature button descriptions — *Continued*

| Button name                           | Button label             | Description  | Maximum                |
|---------------------------------------|--------------------------|--|------------------------|
| send-term                             | Send All Calls-TEG       | Send All Calls For Terminating Extension Group: allows the user to forward all calls directed to a terminating extension group.        | 1 per TEG              |
| serv-obsrv                            | Service Observing        | Service Observing: activates Service Observing. Used to toggle between a listen-only and a listen-talk mode.                           | 1 per station          |
| signal <sup>16</sup><br>(Ext: ___)    | Signal (name or ext #)   | Signal: allows the user to manually signal (via ringing) a station associated with the button.   | 1 per signal extension |
| ssvn-halt                             | ssvn-halt                | Toggle whether or not station security code violation referrals are made to the referral destination.                                  | 1 per station          |
| stored-num                            | Stored Number            | ( <i>display button</i> ) Places the station's display into the stored number mode.  | 1 per station          |
| stroke-cnt                            | ACD SD Stroke Count      | Automatic Call Distribution Single Digit Stroke Count: sends a message to CMS to increment a stroke count number.                      | 1 per station          |
| term-x-gr <sup>17</sup><br>(Grp: ___) | Term Grp (name or ext #) | Terminating Extension Group: provides one or more extensions. Calls may be received but not originated with this button.               | 1 per TEG              |
| timer                                 | Timer                    | ( <i>display button</i> ) Starts a clock on the station to display elapsed time.   | 1 per station          |
| trk-ac-alm                            | FTC Alarm                | Facility Test Call Alarm: associated status lamp lights when a successful Facility Test Call (FTC) occurs.                             |                        |
| trk-id                                | Trunk ID                 | Trunk Identification ( <i>display button</i> ): identifies the tac (trunk access code) and trunk member number associated with a call. | 1 per station          |
| trunk-name                            | Trunk Name               | ( <i>display button</i> ) Displays the name of the trunk as administered on the CAS Main or on a switch without CAS.                   | 1 per station          |
| trunk-ns <sup>18</sup><br>(Grp: ___)  | Trunk Grp                | Trunk-Group Night Service: places a trunk-group into night service.  | 1 per trunk group      |

*Continued on next page*

Table 6-6. Voice-terminal feature button descriptions — *Continued*

| Button name  | Button label            | Description   | Maximum                 |
|--|-------------------------|---|-------------------------|
| verify   | Verify                  | Busy Verification: allows users to make test calls and verify a station or a trunk.   | 1 per station           |
| voa-repeat <sup>19</sup>                           | VOA repeat              | VDN of Origin Announcement.   | 1 per station           |
| vu-display <sup>20</sup><br>(format: __<br>ID: __) | VuStats #               | Enables VuStats and specifies a display format. It is recommended that, on the button label, you add some form of ID for the Display format (#).  | Depends on station type |
| whisp-anbk   | Answerback              | Whisper Page: allows station users to make and receive barge-in announcements to and from other station users without anyone else on the calls being aware of the announcements. These station users must have an administered COR that provides for intraswitch calling. |                         |
| whisp-act  | Whisper Page Activation | See the description of Whisper page above.  |                         |
| whisp-off  | Whisper Page Off        | See the description of Whisper Page above.  |                         |
| work-code <sup>3</sup>                             | Work Code               | Call Work Code: allows an ACD agent after pressing “work-code” to send up to 16 digits (using the dial pad) to CMS.   | 1 per station           |



1. Must be assigned to a dual-lamped line-appearance button.
2. List: List number 1 to 3 where the destination number is stored. DC: dial code number.
3. Grp: The split group number for ACD.
4. atd-qcalls: Zero-seeking attendant calls reported.
5. Ext: Extension of principal. (May be a VDN extension).
6. Grp: Intercom — Auto-lcom group number. This extension and destination extension must be in the same group.
7. TAC/Ext: Trunk or extension of voice terminal to be monitored.
8. Grp: Intercom — Dial (Dial lcom) group number.
9. Flash: Not administrable on attendant consoles.
10. Grp: Hunt group number.

11. Type: A "c" for coverage answer group, "h" for a uniform call distribution or direct department calling group.
  12. Link: Link number — 1 to 8 for multi-carrier cabinets or 1 to 4 for single-carrier cabinets.
  13. Ext: The destination extension. (May be a VDN extension)
  14. Grp: CO line group number.
  15. Grp: Group number of hunt group.
  16. Ext: The extension may not be a VDN extension.
  17. Grp: TEG number.
  18. Grp: Trunk group number.
  19. VDN of Origin Announcement must be enabled.
  20. Requires voice terminal with display. You can administer as many VuStats buttons as there are feature buttons available on the voice terminal. With a different VuStats display format assigned to each button, agents can use different buttons to access different statistics.  
format: the number (from 1 to 25) of the format you want the button to display.  
ID: a split number, trunk group number, agent extension, or VDN extension. The ID defines the agent, split, trunk group, or VDN that the display describes. ID is optional.
-

## Station form field descriptions

This section provides descriptions of standard fields on Station forms. Some of the fields are used for specific voice terminal types; others are used for all terminals. Unique fields and fields that require special consideration are listed with the appropriate voice terminal descriptions later in this book.

### Form Instructions

Page 1 of X

STATION

|                 |                        |        |
|-----------------|------------------------|--------|
| Extension: 1014 | Lock Messages? n       | BCC: 0 |
| Type: 406D      | Security Code: _____   | TN: 1  |
| Port: _____     | Coverage Path 1: _____ | COR: 1 |
| Name: _____     | Coverage Path 2: _____ | COS: 1 |
|                 | Hunt-to-Station: _____ |        |

STATION OPTIONS

|                   |                                 |
|-------------------|---------------------------------|
| Data Module? n    | Personalized Ringing Pattern: 1 |
| Display Module? n | Message Lamp Ext: 1014          |
|                   | MM Complex Data Ext: _____      |

Screen 6-4. Station form (Page 1 of X)

Page 2 of X

STATION

FEATURE OPTIONS

|                                |  |
|--------------------------------|--|
| LWC Reception? msa-spe         | Auto Select Any Idle Appearance? n       |
| LWC Activation? y              | Coverage Msg Retrieval? y                |
| CDR Privacy? n                 | Auto Answer: none                        |
| Redirect Notification? y       | Data Restriction? n                      |
| Per Button Ring Control? n     | Idle Appearance Preference? n            |
| PCOL/TEG Call Alerting? n      | Restrict Last Appearance? y              |
| Active Station Ringing: single | Per Station CPN - Send Calling Number? _ |
| H.320 Conversion? n            |  |
| AUDIX Name: _____              | Audible Message Waiting? n               |
| Messaging Server Name: _____   | Display Client Redirection? n            |
|                                | Select Last Used Appearance? n           |

Screen 6-5. Station form (Page 2 of X)



Page 3 of X

|  |              |  |
|--|--------------|--|
| SITE DATA<br>Room: _____<br>Jack: _____<br>Cable: _____<br>Floor: _____<br>Building: _____       | STATION      | Headset? n<br>Speaker? n<br>Mounting: d<br>Cord Length: 0_<br>Set Color: _____ |
| ABBREVIATED DIALING<br>List1: _____  | List2: _____ | List3: _____   |
| BUTTON ASSIGNMENTS<br>1: call-appr<br>2: call-appr<br>3: call-appr<br>4: cpn-blk<br>5: cpn-unblk |              |  |

Screen 6-6. Station form (Page 3 of X)

## Field descriptions

---

The standard fields are organized alphabetically for easy access.

- **1-Step Clearing** — If you administer 1-step clearing to **n**, a call does not terminate again at the WCBRI terminal when the user drops from the call. If set to **y**, the call terminates again at the WCBRI terminal.
- **Abbreviated Dialing List1, List2, List3** — Enter **p** (personal), **s** (system), **g** (group), or **e** (enhanced). Up to 3 AD lists can be accessed by the voice terminal. If you enter **p** or **g**, you also must enter a personal list number or a group number, respectively.
- **Active Station Ringing** — Defines how a call rings at an off-hook station. Default is single.
  - Enter **continuous** to cause all calls terminated to this station to ring continuously.
  - Enter **single** to cause a call terminated to an off-hook (active or idle) station to receive one ring cycle and then ring silently.
  - Enter **if-busy-single** to cause a call terminated to an off-hook and idle station to ring continuously and a call terminated to an off-hook and active station to receive one ring cycle and then ring silently.
  - Enter **silent** to cause a call terminated to an off-hook (active or idle) station to just ring silently.
- **Adjunct Supervision** — Enter **y** if an analog disconnect signal is sent automatically to the port after a call terminates. Analog devices (such as answering machines and speakerphones) use this signal to turn the

devices off after a call terminates. In a hunt group environment, however, the disconnect signal blocks the reception of zip tone and incoming call notification by an auto-answer station when a call is queued for the station. For these environments, set this field to **n** so hunt group agents are alerted to incoming calls. *Adjunct Supervision* displays only when *Type* is **500, 2500, k2500, 8110, ops, ds1fd, ds1sa, VRU, VRUFD, or VRUSA**.

- **Assigned Member — Ext** — The extension is assigned automatically when the system is administered. This is the extension of the user who has an associated Data Extension button and shares the module.
- **Assigned Member — Name** — Display-only field that contains the name defined for the Assigned Member - Ext.
- **Att. Call Waiting Indication** — Enter **y** to assign Attendant Call Waiting to the voice terminal. This allows attendant-originated and attendant-extended calls to a busy single-line terminal to wait and sends distinctive call-waiting tone to the single-line user. Use of this feature is denied if *Data Restriction* is **y** or *Switchhook Flash* is **n**, or if *Data Privacy* is active via the voice terminal COS assignment.
- **Audible Message Waiting** — Enter **y** to have the voice-terminal user receive stutter dial tone when initiating a call. The tone indicates that the user has a waiting message. This field only appears if *Audible Message Waiting* is active on the System-Parameters Customer-Options form. This field does not control the Message Waiting Lamp.
- **AUDIX Name** — Displays the name of the AUDIX machine as it appears in the User-Defined Adjunct Names form. This field displays only for the R5r or later configuration.
- **Auto Answer** — Enter **all** to allow all calls (ACD and non-ACD) terminated to an idle station to be cut through immediately. Enter **acd** to allow only ACD split/skill calls and direct agent calls to auto answer. If this field is **acd**, Non-ACD calls terminated to a station ring audibly. Enter **none** (default) to cause all calls terminated to this station to receive an audible ringing treatment. In EAS environments, the auto answer setting on the Agent LoginID form may override a station's setting when an agent logs in there.

 **NOTE:**

For analog stations, if *Auto Answer* is **acd** and the station is off-hook and idle, only the ACD split/skill calls and direct agent calls auto answer; non-ACD calls receive busy treatment. If the station is active on an ACD call and a non-ACD call arrives, the Agent receives call-waiting tone.

- **Auto Select Any Idle Appearance** — Enter **y** to allow automatic selection of any idle appearance for transferred or conferenced calls. The system first attempts to find an idle appearance of the call being transferred or conferenced. If that attempt fails, the system selects the first idle appearance. Default is **n**.

- **BCC** — Displays when `ISDN-PRI` or `ISDN-BRI` Trunks is enabled on the System-Parameters Customer-Options form. Display-only field set to 0 for stations (that is, indicates voice or voice-grade data).

See “Generalized Route Selection” in this book for a detailed description of Bearer Capability Classes (BCC) and their ability to provide specialized routing for various types of voice and data calls. The BCC value is used to determine compatibility when non-ISDN facilities are connected to ISDN facilities (ISDN Interworking).

- **Bridged Call Alerting** — Enter **y** to enable audible ringing for TEG, PCOL, bridged appearances, or Data Extension calls. If Bridged Call Alerting is **n** and `Per Button Ring Control` is **n**, audible ringing is suppressed for incoming calls on bridged appearances of another terminal's primary extension.
- **Building** — Enter up to 7 characters to identify the voice-terminal building location. Valid entries are listed in the site table.
- **Button Assignments** — Enter the abbreviated software name to assign a feature button. The feature buttons you can assign to voice terminals are listed with each terminal description.



**NOTE:**

If Terminal Translation Initialization (TTI) is activated, insert no button other than **call-appr** in the first button position. TTI needs the button on the first call appearance to get dial tone.

- **Cable** — Enter up to 5 characters to identify the cable connecting the voice-terminal jack to the system. This field may be left blank. You also can enter this information in the Blank column on the Port Assignment Record.
- **Call Waiting Indication** — Enter **y** to activate Call Waiting Termination for the voice terminal. This allows voice-terminal, attendant-originated, and outside calls to busy single-line terminals to wait and sends a distinctive call-waiting tone to the single-line user. This feature is denied if `Data Restriction` is **y** or `Switchhook Flash` is **n**, or if Data Privacy is active via the voice terminal COS assignment.
- **CDR Privacy** — Enter **y** to enable Call Privacy for each station. This option allows digits in the called number field of an outgoing call record to be blanked, on a per-station basis. The number of blocked digits is administered system-wide in `Privacy - Digits to Hide` on the CDR System Parameters form. Default is **n**.
- **Circuit Switched Data Attributes** — The following fields only appear on the ISDN-BRI Data Module form:
  - **Default Duplex** — Enter **full** (default) or **half** to identify the duplex mode.
  - **Default Mode** — Enter **sync** or **async** (default) to identify the data mode.

— **Default Speed** — Enter **1200** (default), **2400**, **4800**, or **19200** to identify the data rate.

- **COR** — Enter a Class of Restriction (COR) number (**0** through **95**) to select the desired restriction; default is **1**.
- **Cord Length** — Enter a number from **0** to **99** to specify the length (in feet) of the cord attached to the receiver. Default is **0**.
- **COS** — Enter the desired Class of Service (COS) number (**0** through **15**) to select allowed features. Default is **1**.
- **Country Protocol** — Enter the protocol that corresponds to your supported initialization and codesets. The Country Protocol must match any previously-administered endpoint on the same port. The following table lists the valid protocol entries. Default is **1** (US Bellcore).

| Country/Area                           | Protocol |
|--|----------|
| Australia                              | 2        |
| ETSI (Europe)                          | etsi     |
| Japan                                  | 3        |
| Singapore                              | 6        |
| United States (Bellcore National ISDN) | 1        |

- **Coverage Msg Retrieval** — Applies if the voice terminal is marked for LWC Reception. Enter **y** (default) to allow users in the voice terminal Coverage Path to retrieve Leave Word Calling (LWC) messages for this voice terminal.
- **Coverage Module** — Enter **y** to indicate that a coverage module is connected to the station. Entering **y** displays an additional page that contains the button assignment configurations for the module.
- **Coverage Path 1** or **Coverage Path 2** — Enter a coverage-path number or time-of-day table number from a previously-administered Call Coverage Path form or Time of Day Coverage Table form. Enter a coverage path number from **1** to **9999** for R5r and later configurations or from **1** to **999** for R5vs/si and later configurations. Enter a time-of-day coverage table number from **t1** to **t999**. Leave blank if no coverage is desired.



**NOTE:**

If Modified Misoperation is active (Misoperation Alerting is **y** on the Feature-Related System Parameters form), you must assign a Coverage Path to all stations on the switch.

- **CRV Length** — Displays only for ASAI stations. Enter **1** (default) or **2** to indicate the length of CRV for each interface.

- **Data Extension** — Enter the extension assigned to the data module. A data extension can be a 1- to 5-digit number and must agree with the Dial Plan.
- **Data Module** — Enter **y** to indicate that a data module will be administered with the voice terminal. Entering **y** displays the Data Module form.
- **Data Module Capabilities** — The following field displays only on the ISDN-BRI Data Module form:
  - **Origination Default Data Applications** — Identifies the mode for originating data calls if the mode is not specified with the calling parameters. This mode is also used for terminating trunk calls that do not have specified bearer capability or administered connections. Possible mode values are M0 (mode 0), M1 (mode 1), M2 (mode 2), and M3/2 (mode 3/2 adaptable), or blank. Valid entries are **M0**, **M1**, **M2\_A** (default), **M2\_S**, or **M3/2**.
- **Data Restriction** — Enter **y** to prevent tones, such as call-waiting tones, from interrupting user calls. Data restriction provides permanent protection and cannot be changed by the voice-terminal user. Default is **n**. Do not assign a Data Restriction if `Auto Answer` is **all** or **acd**.
- **Default Dialing Abbreviated Dialing Dial Code** — Displays only when the `Special Dialing Option` is set to default. Enter a list number (**0** through **999**) associated with the AD list. When the user goes off-hook and enters a carriage return following the DIAL prompt, the system dials the AD number. The data call originator also can perform data-terminal dialing by specifying a dial string that may or may not contain alphanumeric names.
- **Display Cartridge** — Enter **y** to indicate there is a display cartridge associated with the station (7404D voice terminals only). Entering **y** displays an additional page that contains the button assignment configurations for display buttons. Default is **n**.
- **Display Client Redirection** — Only administrable if `Hospitality` is enabled on the System-Parameters Customer-Options form. This field affects the station's display on calls that originated from a station with Client Room Class of Service. When set to **n**, this station's display does not show the redirection information for all calls originating from a Client Room (even redirected calls) that terminate to this station. Only the client name and extension (or room, depending on what is administered on the System-Parameters Hospitality form) display. When set to **y**, the redirection information for a call originating from a Client Room and terminating to this station displays.



**NOTE:**

For stations with an audix station type, AUDIX Voice Power ports, or ports for any other type of messaging that needs display information, Display Client Redirection must be set to **y**.

- **Display Language** — Displays only when `Display Module` is **y**. Enter **english** (default), **french**, **italian**, **spanish**, or **user-defined** to specify the display language.
- **Distinctive Audible Alert** — Enter **y** (default) so the voice terminal can receive the 3 different types of ringing patterns which identify the type of incoming calls. Features providing distinctive ringing may not work properly toward off-premises voice terminals
- **Endpt ID** — Displays only if `Endpt Init` is **y**. Enter a 2-digit number (**00–62**). Each Endpt ID field must have a unique value for each endpoint on the same port.

This field provides for multipoint configuration conformance to the Bellcore Terminal Initialization procedures. In these procedures, a multipoint configuration requires the last 2 digits of the Service Profile Identifier (SPID) be between 00 and 63 and be binary unique for each endpoint. This field, combined with the SPID, gives the effective SPID administered into the terminal. Bellcore ISDN-1 requires the SPID programmed into the endpoint contain at least 9 digits. (For example, if the SPID is **1234**, and `Endpt ID` is **01**, then the SPID administered on the terminal is 000123401. The three leading zeros are necessary to create a 9-digit SPID.)

- **Endpt Init** — Displays only if `MIM Support` is **y** and indicates the terminal's endpoint initialization capability. Enter **y** (default) if the terminal supports Bellcore ISDN-1 terminal initialization procedures. Enter **n** for all other country protocols.

Endpoint initialization is a procedure, required for multipoint operation, by which User Service Order Profile (USOP) is associated with an endpoint on the ISDN-BRI. This association is made via the SPID, administered into the system, and entered into the ISDN-BRI terminal. For an ISDN-BRI terminal to be operational in a multipoint configuration, both the administered SPID and the SPID programmed into the ISDN-BRI terminal must be the same. Therefore, the SPID of new or reused terminals must be programmed to match the administered SPID value.

- **Event Minimization** — Allows you to minimize events sent on a link. It displays only if you set `Type` to **asai**. Enter **y** when an application or library does not want to receive identical event reports over different associations. When minimization is enabled, the switch sends a single event report on only one association and discards any remaining reports. It is up to the library or application to report this event to other interested parties or applications. Default is **n**.
- **Extension** — Displays the extension you specified when you accessed this form. When administering the form, enter a valid extension (1 to 5 digits) to access the form.
- **Feature Module** — Enter **y** to indicate the station is connected to a feature module. Default is **n**. Entering **y** displays an additional page that contains the button assignment configurations for the module.

- **Fixed TEI** — For ASAI, enter **y**. This field displays only for ISDN-BRI data modules and ASAI links. It indicates that the endpoint has a fixed Terminal Endpoint Identifier (TEI). The TEI identifies a unique access point within a service. You must administer TEIs for fixed TEI terminals. However, for terminals with the automatic TEI capability, the system dynamically assigns the TEI. Entering **y** displays the TEI field.
- **Floor** — Enter up to 7 characters to identify the voice-terminal floor location.
- **H.320 Conversion** — Allows H.320 compliant calls made to this voice terminal to be converted to voice-only. Because the system can only handle a limited number of conversion calls, you may need to limit the number of terminals with H.320 conversion.
- **Headset** — Enter **y** if the terminal has a headset.
- **HOT LINE DESTINATION — Abbreviated Dialing Dial Code** — Displays only when `Special Dialing Option` is **hot-line**. Enter a list number (associated with the AD List) from **0** to **999**. When the user goes off-hook on a Data Hot Line call, the system dials the AD number.
- **HOT LINE DESTINATION — Abbreviated Dialing List Number** — Enter **1**, **2**, **3**, or leave blank (default) to identify the abbreviated dialing list to access when originating a call.
- **HOT LINE DESTINATION — Dial Code** — Enter a number from **0** to **999** or leave blank (default). This field is the index for the Abbreviated Dialing List that contains the digits to be dialed when originating a call.
- **Hunt-to Station** — Enter the extension the system should hunt to for this station when the station is busy. This entry functions as one entry in a station hunting chain. You must specify an extension defined as a local voice station in your dial plan. A station cannot be its own hunt-to station. This field displays only when `Type` is **500**, **2500**, **k2500**, **7101A**, **7103A**, **7104A**, or **8110**.
- **Idle Appearance Preference** — Enter **y** or **n** (default) to indicate which call appearance is selected when the user lifts the handset and there is an incoming call. If you enter **y**, the user connects to an idle call appearance instead of the ringing call. If you enter **n**, the Alerting Appearance Preference is set and the user connects to the ringing call appearance.
- **Ignore Rotary Digits** — Enter **y** to indicate that rotary digits from the set should be ignored. Enter **n** (default) to make sure they are not ignored. If this field is **y**, the short switch hook flash (50 -150) from a 2500-type set is ignored.
- **ITC** — (Information Transfer Capability) Enter **restricted** (default) or **unrestricted** to indicate the type of transmission facilities to be used for ISDN calls originated from this endpoint. The field does not display for voice-only or BRI stations.

- If you set to **restricted**, either restricted or unrestricted transmission facilities are used to complete the call. A restricted facility is a transmission facility that enforces 1's density digital transmission (that is, a sequence of 8 digital zeros are converted to a sequence of 7 zeros and a digital 1).
- If you set to **unrestricted**, only unrestricted transmission facilities are used to complete the call. An unrestricted facility is a transmission facility that does not enforce 1's density digital transmission (that is, digital information is sent exactly as is).
- **Jack** — Enter up to 5 characters to identify the jack location for the voice terminal connection. This field may be left blank.
- **Lock Messages** — Enter **y** to restrict other users from reading or canceling the voice-terminal messages or retrieving messages via Voice Message Retrieval. Default is **n**.
- **LWC Activation**— Enter **y** (default) to allow internal voice-terminal users to leave short LWC messages for this terminal. If the system has hospitality, enter **y** for guest-room voice terminals if the terminal designated to receive failed wakeup messages should receive LWC messages that indicate the wakeup calls failed. Enter **y** if LWC Reception is **audix**.
- **LWC Reception** — Enter **msa-spe** (default) if LWC messages are stored in the system or on the Messaging Server Adjunct - Switch Processor. Enter **audix** if the messages are stored on the Audio Information Exchange System. Default is **none**.
- **Message Lamp Ext** — Enter the extension of the station to be tracked. Default is the station's extension. This field displays only when **Type** is **7101A**, **7103A**, **8110**, or **VRU**.
- **Message Waiting Indicator** — Enter **led** if the message waiting indicator is a light-emitting diode (LED). Enter **neon** if the indicator is a neon indicator. This field displays only for ISDN-BRI data modules and for 500, 2500, K2500, 7104A, 8110, and VRU voice terminals.
- **Messaging Server Name** — Displays the name of the server as it appears in the User-Defined Adjunct Names form. This field displays only for the R5r and later configuration.
- **MIM Mtce/Mgt** — Displays only if **MIM Support** is **y**. It indicates if the terminal supports MIM Maintenance and Management capabilities other than endpoint initialization. Default is **n**.
- **MIM Support** — (Management Information Message Support) This field displays only for ISDN-BRI data modules and ASAI. This field supports MIM endpoint initialization (SPID support) and other Maintenance or Management capabilities. Enter **n** for ASAI. Enter **y** to display **Endpt Init** and **MIM Mtce/Mgt**.



- **MM Complex Data Ext** — The extension assigned to the data module of the multimedia complex. User can dial this extension to place either a voice or a data call, and voice conversion, coverage, and forwarding apply as if the call were made to the 1-number. Valid values conform with your dial plan.
- **Multimedia Early Answer** — Allows you to establish multimedia early answer on a station-by-station basis. If this station will receive coverage calls for multimedia complexes, but is not multimedia-capable, enter **y** to ensure that calls are converted and talk path is established before ringing at this station.
- **Name** — Enter up to a 27-character name for the person associated with this voice terminal or data module. This field can be shared with a Room number. The name assigned to a voice terminal remains with that voice terminal until it is changed. The Integrated Directory lists the names as they should be entered on the forms.
- **Off Premise Station** — (analog terminals only) Enter **y** if this voice terminal is not located in the same building with the system. Enter **n** (default) if the voice terminal is located in the same building with the system. If you enter **y**, you must complete **R Balance Network**.
- **PCOL/TEG Call Alerting** — Displays only for 510 voice terminals. Enter **y** to alert the station for Personal CO Line/Terminating Extension Group calls. Default is **n**.
- **Per Button Ring Control** — Enter **y** to allow users to select ring behavior individually for each call-appr, brdg-appr, or abrdg-appr on the station and to enable Automatic Abbreviated and Delayed ring transition for each call-appr on the station. Also, enter **y** if you do not want the system to automatically move the line selection to a silently alerting call unless that call was audibly ringing earlier. Enter **n** (default) if you want calls on call-appr buttons to always ring the station and calls on brdg-appr or abrdg-appr buttons to always ring or not ring based on the **Bridged Call Alerting** field value. Also, enter **n** if you want the system to move line selection to a silently alerting call if there is no call audibly ringing the station.
- **Personalized Ringing Pattern** — Enter a Personalized Ringing Pattern (1 through 8) according to the following table. (L = 530 Hz, M = 750 Hz, and H = 1060 Hz) Default is 1.

| Ring pattern | Tone sequence          |
|--------------|------------------------|
| 1            | MMM (standard ringing) |
| 2            | HHH                    |
| 3            | LLL                    |
| 4            | LHH                    |
| 5            | HHL                    |

| Ring pattern | Tone sequence |
|--------------|---------------|
| 6            | HLL           |
| 7            | HLH           |
| 8            | LHL           |

- **Per Station CPN - Send Calling Number** — Valid entries are:
  - **y** — all outgoing calls from the station will deliver the Calling Party Number (CPN) information as “Presentation Allowed.”
  - **n** — no CPN information is sent for the call.
  - **r** — outgoing non-DCS network calls from the station will deliver the Calling Party Number information as “Presentation Restricted.”
  - **blank (unadministered)** — the sending of CPN information for calls is controlled by any administration on the outgoing trunk group the calls are carried on. This is the default.
- **Port** — Enter 7 characters to specify a port as follows:

| Characters | Meaning        | Value  |
|------------|----------------|--|
| 1-2        | Cabinet Number | 01 through 44 (R5r)<br>01 through 03 (R5si)<br>01 (R5vs) |
| 3          | Carrier        | A through E  |
| 4-5        | Slot Number    | 01 through 20  |
| 6-7        | Circuit Number | 01 through 32  |



**NOTE:**

You can enter X in `Port` to indicate that there is no hardware associated with the port assignment (Administration Without Hardware). These stations are referred to as phantom or AWOH stations.

For DCP sets, the port can only be assigned once. ISDN-BRI provides a multipoint configuration capability that allows a previously assigned port to be specified more than once as follows: 2 stand-alone voice endpoints, 2 stand-alone data endpoints, or 1 integrated voice and data endpoint.

However, for the following cases, the port is assumed to be fully assigned:

- Maximum number of users (currently 2) are assigned on the port.
- One of the users on the port is a fixed TEI station.
- One of the users on the port has B-channel voice and B-channel data capability.

- One of the users on the port has no SPID assigned, which includes terminals that have no SPID initialization capability.
- **R Balance Network** — Enter **y** to select the R Balance Capacitor network. Enter **n** (default) to select the standard resistor capacitor network. You must complete this field if *Off-Premise Station* is **y**. Enter **n** when the station port circuit is connected to terminal equipment (such as SLC carriers or impedance compensators) optioned for 600-ohm input impedance and the distance to the terminal equipment from the system is less than 3,000 feet. Enter **y** in all other cases.
- **Redirect Notification** — Enter **y** (default) to give a half ring at this voice terminal when calls to this terminal are redirected (via Call Forwarding or Call Coverage). Enter **y** if *LWC Reception* is **audix**.
- **Restrict Last Appearance** — Enter **y** (default) to restrict the last idle call appearance for incoming priority calls and outgoing call originations only.
- **Room** — Enter up to 10 characters to identify the voice terminal location. Enter up to 5 characters to identify the guest room number, if this station is one of several to be assigned a guest room and the *Display Room Information* in Call Display is **y** on the Hospitality-Related System Parameters form. This field may be blank.
- **Security Code** — Enter the 3- to 8-digit security code required by users for specific system features and functions, including Personal Station Access, Redirection of Calls Coverage Off-Net, Leave Word Calling, Message Retrieval, and Demand Printing. The required security code length is determined by *Minimum Security Code Length* on the Feature-Related System Parameters form.
- **Select Last Used Appearance** — Enter **y** to indicate a station's line selection is not to be moved from the currently selected line button to a different, non-alerting line button. If you enter **y**, the line selection on an on-hook station only moves from the last used line button to a line button with an audibly alerting call. If there are no alerting calls, the line selection remains on the button last used for a call. Enter **n** so the line selection on an on-hook station with no alerting calls can be moved to a different line button, which may be serving a different extension.
- **Set Color** — Enter up to 6 characters to describe the set color.
- **Speakerphone** — Enter **y** to indicate a speakerphone is attached to the voice terminal. Default is **n**.
- **Special Dialing Option** — Enter **hot-line**, **default**, or leave blank for regular (normal) keyboard dialing. This field identifies the type of dialing for calls when this data module originates calls.
- **SPID** — (Service Profile Identifier) This field displays only if *Endpt Init* is **y**. Enter a variable length parameter (up to 10 digits). SPID is a numeric string, which means that the value of 00 is different from 000. The SPID must be different for all terminals on the BRI and from the Service SPID. The SPID should always be assigned. If the SPID is not assigned for the

first BRI on a port, any other BRI assignment to that port are blocked. Valid entries are numeric strings in the range of **0** through **9999999999**. Default is the station extension.

 **NOTE:**

If using Administration Without Hardware for an ISDN-BRI extension (`Port` set to `X`) and Terminal Translation Initialization (TTI) is intended to be used to assign the port, then the SPID number must equal the station number.

- **Switchhook Flash** — Enter **y** (default) to allow users to use the switchhook flash function to activate Conference/Transfer/Hold and Call Waiting. Enter **n** to disable the flash function so that when the switchhook is pressed while active on a call, the call drops. If this field is **n**, you must set `Call Waiting Indication` to **n**.
- **TEI** — Displays only when `Fixed TEI` is **y**. Enter a 1- or 2-digit number from **0** through **63**. Default is blank.
- **Tests** — Enter **y** (default) to enable port maintenance tests. If the terminal equipment (dictaphone) connected to the port does not support these tests, you must enter **n**.
- **TN** — Enter the Tenant Partition number. Default is **1**.
- **Type** — Enter the voice-terminal type. See [Table 6-4](#) for a list of voice terminals.
- **XID** — Displays only for an ISDN-BRI data module or an ASAI link. Used to identify layer 2 XID testing capability. Valid entries are **y** (default) or **n**.

## 10-MET, 20-MET, and 30-MET voice terminals

The 10-, 20-, and 30-multielectronic telephone (MET) voice terminals contain 10, 20, and 30 feature buttons, respectively.

### Form instructions

To administer a 10-MET, 20-MET, or 30-MET voice terminal, complete the standard as well as the following unique Station form fields.

### Page 1 of the form

Page 1 of X

STATION

|                 |                        |         |
|-----------------|------------------------|---------|
| Extension: 1003 | Lock Messages? n       | BCC: 0  |
| Type: 10MET__   | Security Code: _____   | TN: 1__ |
| Port: _____     | Coverage Path 1: _____ | COR: 1_ |
| Name: _____     | Coverage Path 2: _____ | COS: 1_ |
|                 | Hunt-to Station: _____ |         |

STATION OPTIONS

Message Lamp Ext: 1000\_

MM Complex Data Ext: \_\_\_\_\_

### Screen 6-7. 10-MET, 20-MET, and 30-MET form (Page 1 of X)

- **Type** — Enter **10MET**, **20MET**, or **30MET** as appropriate.

Page 2 of X

|  |  |
|--|--|
| FEATURE OPTIONS<br>LWC Reception: msa-spe<br>LWC Activation? y<br>CDR Privacy? n<br>Redirect Notification? y<br>Per Button Ring Control? n<br>Bridged Call Alerting? n<br><br>H.320 Conversion? n<br><br>AUDIX Name: _____<br>Messaging Server Name: _____ | STATION<br>Auto Select Any Idle Appearance? n<br>Coverage Msg Retrieval? y<br>Auto Answer: none<br>Data Restriction? n<br>Idle Appearance Preference? n<br><br>Restrict Last Appearance? y<br><br>Multimedia Early Answer? n<br>Audible Message Waiting? n<br><br>Select Last Used Appearance? n |
|--|--|

**Screen 6-8. 10-MET, 20-MET, and 30-MET form (Page 2 of X)**

**Page 3 of the form**

■ **BUTTON ASSIGNMENTS**

The feature buttons that you can assign to the MET voice terminals are listed below. The first 3 buttons are defaulted as call appearance.

|            |            |            |            |
|------------|------------|------------|------------|
| abr-prog   | abr-spchar | abrdg-appr | abrv-dial  |
| abrv-ring  | ac-alarm   | aca-halt   | after-call |
| alrt-agchg | alt-frl    | assist     | asvn-halt  |
| atd-qcalls | atd-qtime  | aut-msg-wt | auto-cback |
| auto-icom  | auto-in    | autodial   | aux-work   |
| brdg-appr  | busy-ind   | call-appr  | call-fwd   |
| call-park  | call-pkup  | cas-backup | cdr1-alm   |
| cdr2-alm   | cfwd-bsyda | consult    | cov-cback  |
| data-ext   | dial-icom  | dir-pkup   | dn-dst     |
| ds1-alarm  | exclusion  | flash      | goto-cover |
| hunt-ns    | in-call-id | int-aut-an | last-numb  |
| link-alarm | lsvn-halt  | lwc-cancel | lwc-store  |
| major-alm  | man-msg-wt | manual-in  | mct-act    |

*Continued on next page*

|                        |            |            |            |
|------------------------|------------|------------|------------|
| mct-contr              | mj/mn alm  | night-serv | noans-alm  |
| per-COline             | pms-alarm  | pr-awu-alm | pr-pms-alm |
| pr-sys-alm             | print-msgs | priority   | q-calls    |
| q-time                 | release    | ringer-off | rs-alert   |
| rsvn-halt              | send-calls | send-term  | serv-obsrv |
| signal                 | ssvn-halt  | stroke-cnt | term-x-gr  |
| trk-ac-alm             | trunk-ns   | verify     | voa-repeat |
| work-code <sup>1</sup> |            |            |            |

---

1. Stations administered with displays only.

**Page 4 of the form (20-MET and 30-MET only)**

Page 4 of 4

| FEATURE BUTTON ASSIGNMENTS | STATION   |
|----------------------------|-----------|
| 1: _____                   | 11: _____ |
| 2: _____                   | 12: _____ |
| 3: _____                   | 13: _____ |
| 4: _____                   | 14: _____ |
| 5: _____                   | 15: _____ |
| 6: _____                   | 16: _____ |
| 7: _____                   | 17: _____ |
| 8: _____                   | 18: _____ |
| 9: _____                   | 19: _____ |
| 10: _____                  | 20: _____ |

**Screen 6-9. 20-MET and 30-MET form (Page 4 of 4)**

■ **FEATURE BUTTON ASSIGNMENTS**

The feature buttons that you can assign to the 20/30 MET terminals are the same as those listed for BUTTON ASSIGNMENTS above. Feature Buttons 1-10 only display for 20-MET terminals. Feature Buttons 11-20 only display for 30-MET terminals.

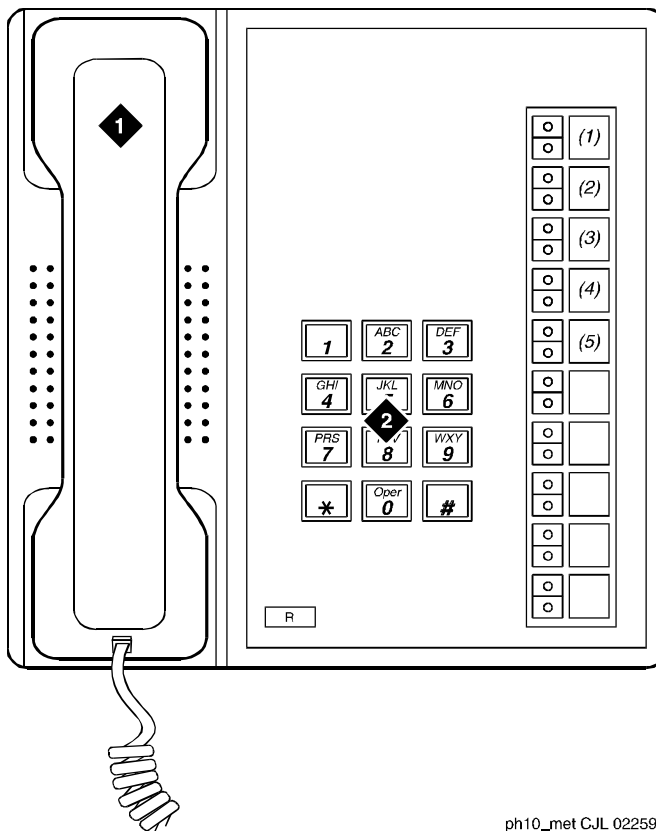

ph10\_met CJL 022597

Figure Notes

1. Handset

2. Dial pad

Figure 6-1. 10-MET voice terminal



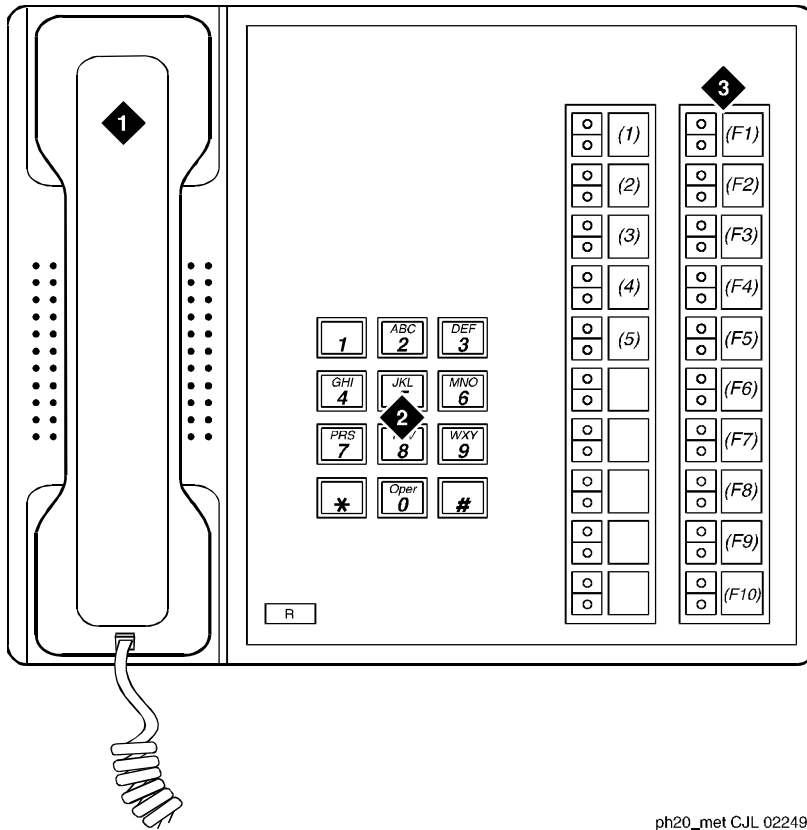

ph20\_met CJL 022497

Figure Notes

- 1. Handset
- 2. Dial pad

- 3. 10 administrable buttons

Figure 6-2. 20-MET voice terminal

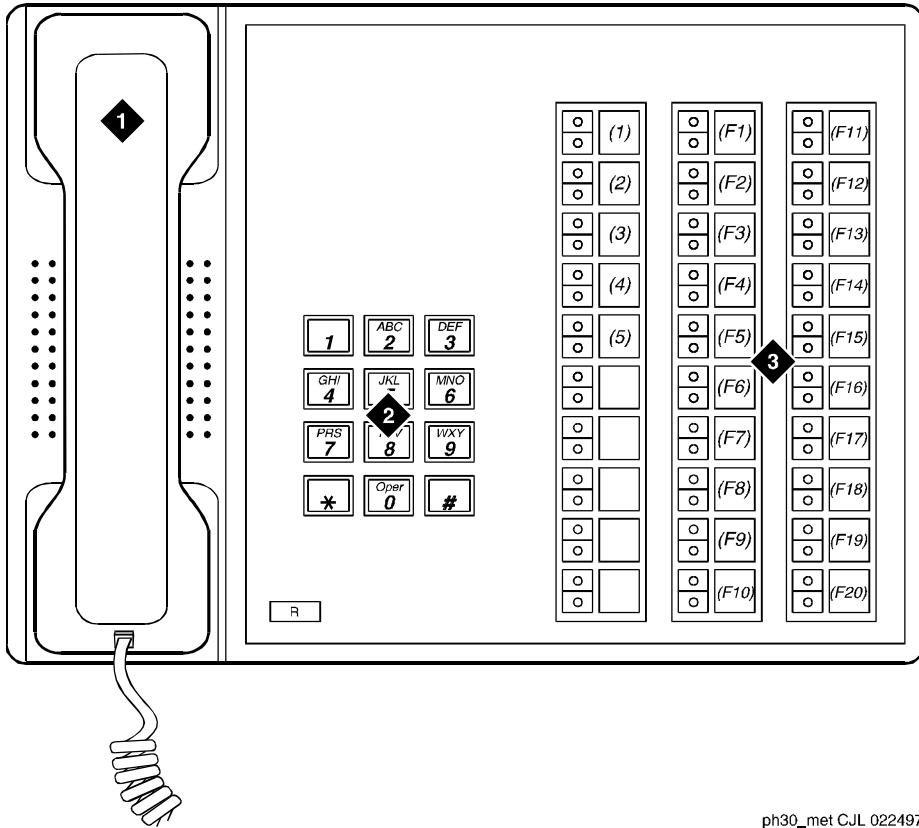

ph30\_met C.J.L. 022497

Figure Notes

- 1. Handset
- 2. Dial pad

- 3. 20 administrable buttons

Figure 6-3. 30-MET voice terminal

## 500, 2500, K2500, 7101A, 7102A, 7103A, 7104A, 8110, DS1FD, DS1SA, and VRU voice terminals

DEFINITY allows you to administer the following single-line voice terminals: 500, 2500, K2500, 7101A, 7102A, 7103A, 7104A, 8110, DS1FD, DS1SA, or VRU voice terminals.

### Form instructions

To administer a single-line voice terminal, complete the standard as well as the following unique Station form fields.

#### NOTE:

You administer a K2500 Key Phone System Interface the same as you would a 2500 voice terminal, but the K2500 has the ability to accept either rotary or DTMF digits. You cannot administer the K2500 to ports on a TN2135 Analog Line circuit pack

### Page 1 of the form

Page 1 of 3

| STATION                |                                  |          |
|------------------------|----------------------------------|----------|
| Extension: 1003        | Lock Messages? n                 | BCC: 0   |
| Type: 500__            | Security Code: _____             | TN: 1__  |
| Port: _____            | Coverage Path 1: _____           | COR: 1__ |
| Name: _____            | Coverage Path 2: _____           | COS: 1__ |
|                        | Hunt-to Station: _____           | Tests? y |
| <b>STATION OPTIONS</b> |                                  |          |
| Off Premise Station? y | Message Waiting Indicator: _____ |          |
| R Balance Network? n   | Message Lamp Ext: 1000__         |          |

### Screen 6-10. Single-line Station form (Page 1 of 3)

- **Type** — Enter **500, 2500, k2500** (see note), **7101A, 7103A, 7104A, 8110, ops, ds1fd, ds1sa, VRU, VRUFD, or VRUSA**.
  - For a 7102A voice terminal, enter **7101A**.
  - For a 2500 DMGC voice terminal, enter **7101A**. This enables the Recall button and switchhook flash functions.

- When the forward disconnect message is needed for DS-1 ports (Lineside DS1), enter **ds1fd**, **ds1sa**, **VRUFD**, **VRUSA**, and a DS-1 circuit pack, either TN767E (or later) or TN464F (or later) circuit pack.
- The **ds1sa** or **vrusa** support special access signaling; the **ds1fd** or **vrufd** support exchange signaling. The forward disconnect signal for both of these station types is a transition of the a signaling bit for 600ms. The call endpoint (typically a VRU) must have the ability to respond to the disconnect message. If a DS1 port is translated with a 500 or 2500 voice terminal, the DS1 protocol does not provide a means of sending forward disconnect.
- The **ops** is a DS1 type without a forward disconnect signal.
- Enter **ops**, **ds1fd**, **ds1sa**, **VRUFD**, or **VRUSA** to allow a voice response unit such as Conversant to interface with a DS1 board on the switch. At the far end, the voice response unit typically uses a DS0 on a channel bank. At the PBX, the DS0 enters the switch on the DS1 trunk to which the channel bank is connected.
- The **ds1sa** is the same as the **ds1fd**, but also includes messages to support the special access signaling required by the VRUs. The **ds1sa** supports all the fields that the **ds1sa** does and uses the same TN767C or greater circuit pack.
- VRU, VRUFD, and VRUSA are valid types only if **DTMF Feedback Signals for VRU** is enabled on the Customer-Options System Parameters form. The VRU type is used for an analog port while VRUFD or VRUSA are used for DS1 ports.

| FEATURE OPTIONS            | STATION                         |
|----------------------------|---------------------------------|
| LWC Reception: msa-spe     |                                 |
| LWC Activation? y          | Coverage Msg Retrieval? y       |
| CDR Privacy? n             | Auto Answer: none               |
| Redirect Notification? y   | Data Restriction? n             |
| Per Button Ring Control? n | Call Waiting Indication? y      |
| Bridged Call Alerting? n   | Att. Call Waiting Indication? y |
| Switchhook Flash? y        | Distinctive Audible Alert? y    |
| Ignore Rotary Digits? n    | Adjunct Supervision? y          |
| H.320 Conversion? n        |                                 |
| AUDIX Name: _____          | Multimedia Early Answer? n      |
|                            | Audible Message Waiting? n      |

Screen 6-11. Single-line Station form (Page 2 of 3)

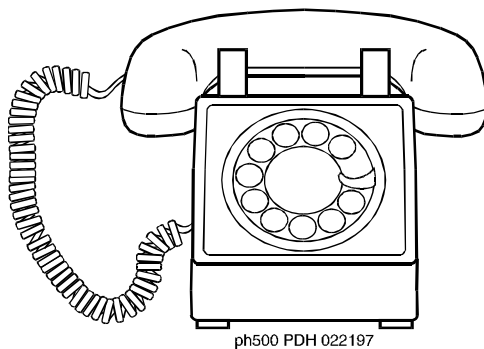

---

**Figure 6-4. 500 voice terminal**

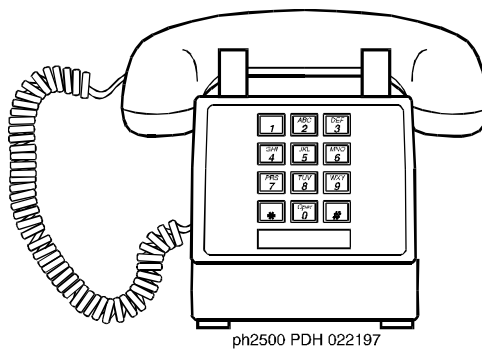

---

**Figure 6-5. 2500 voice terminal**

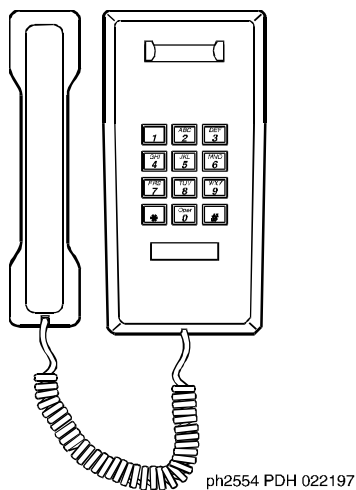

---

**Figure 6-6. 2554 voice terminal**

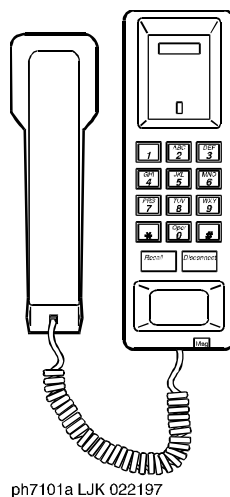

---

**Figure 6-7. 7101A voice terminal**

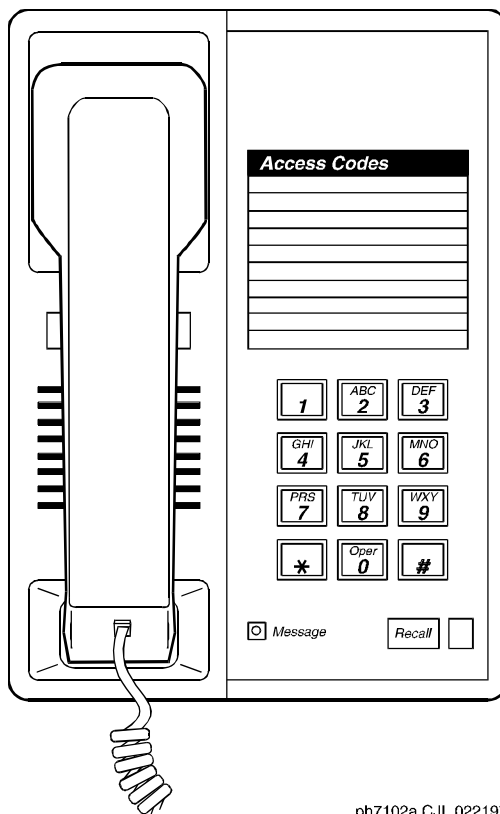

ph7102a C/JL 022197

Figure 6-8. 7102A voice terminal

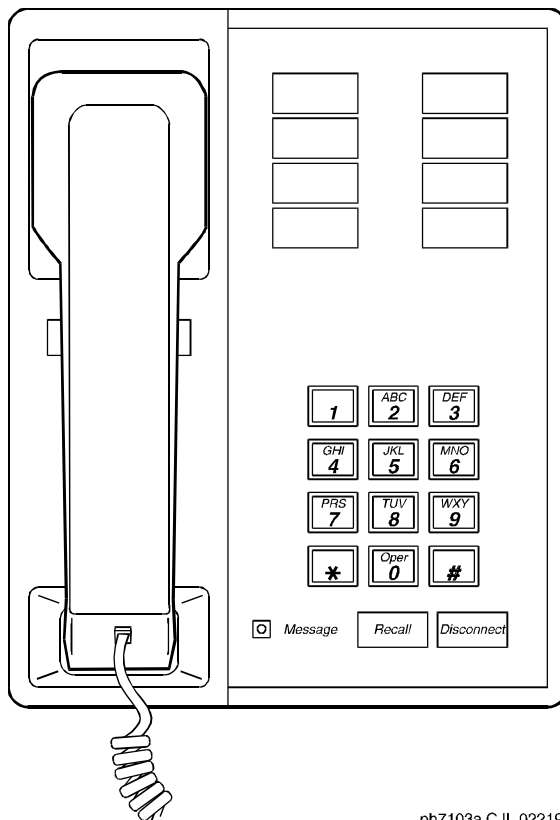
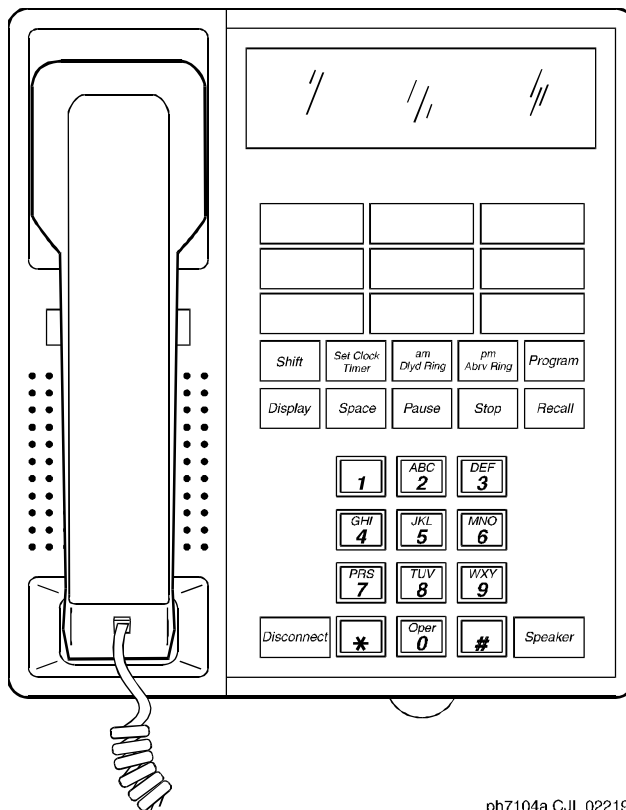

Figure 6-9. 7103A voice terminal





ph7104a CJL 022197

Figure 6-10. 7104A voice terminal

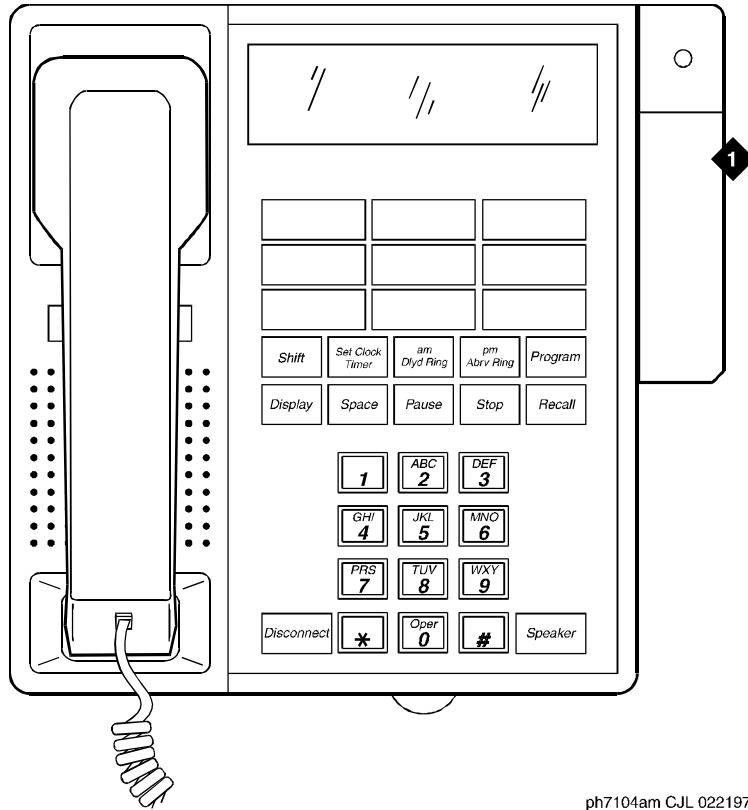

ph7104am CJL 022197

Figure Notes

1. Message waiting adjunct

Figure 6-11. 7104A voice terminal w/Message Waiting

## 510D personal terminal and 515 business communications terminal

### Form Instructions

To administer a 510D personal terminal (PT) or 515 business communications terminal (BCT), complete the standard as well as the following unique Station form fields.

### Page 1 of the form

|                           |                        |                         |
|---------------------------|------------------------|-------------------------|
| STATION                   |                        | Page 1 of X             |
| Extension: 1003           | Lock Messages? n       | BCC: 0                  |
| Type: 510____             | Security Code: _____   | TN: 1__                 |
| Port: _____               | Coverage Path 1: _____ | COR: 1__                |
| Name: _____               | Coverage Path 2: _____ | COS: 1__                |
|                           | Hunt-to Station: _____ |                         |
| STATION OPTIONS           |                        |                         |
| Data Module? y            |                        | Message Lamp Ext: 1000_ |
| Display Module? y         |                        |                         |
| Display Language: english |                        |                         |

### Screen 6-12. 510D and 515 BCT form (Page 1 of X)

- **Type** — Enter **510** or **515** as appropriate.
- **Data Module** — Display-only field. Restricted to y.
- **Display Module** — Display-only field. Restricted to y.

### Page 2 of the form

|                                |                                    |             |
|--------------------------------|------------------------------------|-------------|
| STATION                        |                                    | Page 2 of X |
| FEATURE OPTIONS                |                                    |             |
| LWC Reception? msa-spe         | Auto Select Any Idle Appearance? n |             |
| LWC Activation? y              | Coverage Msg Retrieval? y          |             |
| CDR Privacy? n                 | Auto Answer: none                  |             |
| Redirect Notification? y       | Data Restriction? n                |             |
| Per Button Ring Control? n     | Idle Appearance Preference? n      |             |
| PCOL/TEG Call Alerting? n      | Restrict Last Appearance? y        |             |
| Active Station Ringing: single |                                    |             |
| H.320 Conversion? n            | Multimedia Early Answer? n         |             |
| AUDIX Name: _____              | Audible Message Waiting? n         |             |
| Messaging Server Name: _____   | Display Client Redirection? n      |             |
|                                | Select Last Used Appearance? n     |             |

### Screen 6-13. 510D and 515 BCT form (Page 2 of X)

- **Bridged Call Alerting** — (515 BCT only) Enter **y** to allow incoming calls on bridged appearances of another terminals primary extension or TEG or PCOL calls to alert at this terminal. Default is **n**.

**Page 3 of the form**

Page 3 of X

|  |           |  |              |          |              |          |              |          |          |          |          |           |
|--|-----------|--|--------------|----------|--------------|----------|--------------|----------|----------|----------|----------|-----------|
| SITE DATA<br>Room: _____<br>Jack: _____<br>Cable: _____<br>Floor: _____<br>Building: _____   | STATION   | Headset? n<br>Speaker? n<br>Mounting: d<br>Cord Length: 0_<br>Set Color: _____ |              |          |              |          |              |          |          |          |          |           |
| ABBREVIATED DIALING<br>List1: _____                      List2: _____                      List3: _____  |           |  |              |          |              |          |              |          |          |          |          |           |
| BUTTON ASSIGNMENTS<br><table style="width: 100%; border-collapse: collapse;"> <tr> <td style="width: 50%;">1: call-appr</td> <td style="width: 50%;">6: _____</td> </tr> <tr> <td>2: call-appr</td> <td>7: _____</td> </tr> <tr> <td>3: call-appr</td> <td>8: _____</td> </tr> <tr> <td>4: _____</td> <td>9: _____</td> </tr> <tr> <td>5: _____</td> <td>10: _____</td> </tr> </table> |           |  | 1: call-appr | 6: _____ | 2: call-appr | 7: _____ | 3: call-appr | 8: _____ | 4: _____ | 9: _____ | 5: _____ | 10: _____ |
| 1: call-appr   | 6: _____  |  |              |          |              |          |              |          |          |          |          |           |
| 2: call-appr   | 7: _____  |  |              |          |              |          |              |          |          |          |          |           |
| 3: call-appr   | 8: _____  |  |              |          |              |          |              |          |          |          |          |           |
| 4: _____   | 9: _____  |  |              |          |              |          |              |          |          |          |          |           |
| 5: _____   | 10: _____ |  |              |          |              |          |              |          |          |          |          |           |

**Screen 6-14. 510D and 515 BCT form (Page 3 of X)**

- **Button Assignments**

The feature buttons that you can assign to the 510PT and 515 BCT are listed below. The first 3 button assignments default to call appearance for both terminals. Button Assignments 5 through 10 display only on the 515 BCT form.

|                         |                         |                         |                         |
|-------------------------|-------------------------|-------------------------|-------------------------|
| abr-prog                | abr-spchar              | abrdg-appr              | abrv-dial               |
| abrv-ring               | ac-alarm                | aca-halt                | after-call              |
| alrt-agchg              | alt-frl                 | assist                  | asvn-halt               |
| atd-qcalls <sup>1</sup> | atd-qtime <sup>1</sup>  | aut-msg-wt              | auto-cback              |
| auto-icom               | auto-in                 | auto-wkup <sup>1</sup>  | autodial                |
| aux-work                | brdg-appr               | busy-ind                | call-appr               |
| call-disp <sup>1</sup>  | call-fwd                | call-park               | call-pkup               |
| callr-info <sup>1</sup> | cas-backup              | cdr1-alm                | cdr2-alm                |
| cfwd-bsyda              | check-in <sup>1</sup>   | check-out <sup>1</sup>  | clk-overid <sup>1</sup> |
| consult                 | cov-cback               | cov-msg-rt <sup>1</sup> | data-ext                |
| date-time <sup>1</sup>  | delete-msg <sup>1</sup> | dial-icom               | directory <sup>1</sup>  |
| dir-pkup                | disp-chrg               | disp-norm               | dn-dst                  |

|                        |                         |                         |                         |
|------------------------|-------------------------|-------------------------|-------------------------|
| ds1-alarm              | exclusion               | ext-dn-dst <sup>1</sup> | flash                   |
| goto-cover             | grp-dn-dst <sup>1</sup> | hunt-ns                 | in-call-id              |
| inspect <sup>1</sup>   | int-aut-an              | last-numb               | link-alarm              |
| lsvn-halt              | lwc-cancel              | lwc-lock                | lwc-store               |
| major-alm              | man-msg-wt              | man-overid <sup>1</sup> | manual-in               |
| mct-act                | mct-contr               | mj/mn-alm               | msg-retr <sup>1</sup>   |
| mwn-act <sup>1</sup>   | mwn-deact <sup>1</sup>  | next <sup>1</sup>       | night-serv              |
| noans-alm              | normal <sup>1</sup>     | per-COline              | pms-alarm               |
| pr-awu-alm             | pr-pms-alm              | pr-sys-alm              | print-msgs              |
| priority               | q-calls                 | q-time                  | release                 |
| ringer-off             | rs-alert                | rsvn-halt               | scroll                  |
| send-calls             | send-term               | serv-obsrv              | signal                  |
| ssvn-halt              | stored-num <sup>1</sup> | stroke-cnt              | term-x-gr               |
| timer <sup>1</sup>     | trk-ac-alm              | trk-id                  | trunk-name <sup>1</sup> |
| trunk-ns               | verify                  | voa-repeat              | vu-display              |
| work-code <sup>2</sup> |                         |                         |                         |

- 
1. Display-type buttons
  2. Stations administered with displays only

**Page 4 of the form (510D Only)**

Page 4 of X

STATION

FEATURE BUTTON ASSIGNMENTS

Column 1: 1: \_\_\_\_\_  
 2: \_\_\_\_\_  
 3: \_\_\_\_\_

Column 2: 4: \_\_\_\_\_  
 5: \_\_\_\_\_  
 6: \_\_\_\_\_

Column 3: 7: \_\_\_\_\_  
 8: \_\_\_\_\_  
 9: \_\_\_\_\_

**Screen 6-15. 510D Station form (Page 4 of X)**

■ **Feature Button Assignments**

The features and functions that you can assign to Page 4 of X are the same as those listed for BUTTON ASSIGNMENTS above.

**Page X of the form**

■ **(Display Button Assignments)**

The features and functions that you can assign are the same as those above and are noted as display buttons.

```

                                                                 Page Y of X
                                STATION
DISPLAY BUTTON ASSIGNMENTS
1: _____
2: _____
3: _____
4: _____
5: _____
6: _____
7: _____
```

Screen 6-16. 510D and 515 BCT Station form (Page Y of X)

```

                                                                 Page Y of X
                                STATION
DATA MODULE
  Data Extension: _____ Name: _____ BCC: 2
                                COS: 1_
                                COR: 1_
                                TN: 1_
      ITC: restricted
ABBREVIATED DIALING
List1: _____
SPECIAL DIALING OPTION: _____
HOT LINE DESTINATION
DEFAULT DIALING
  Abbreviated Dialing Dial Code (From above list): _____
ASSIGNED MEMBER (Station with a data extension button for this data module)
  Ext      Name
1:
```

Screen 6-17. 510D and 515 BCT Data Module form (Page Y of X)

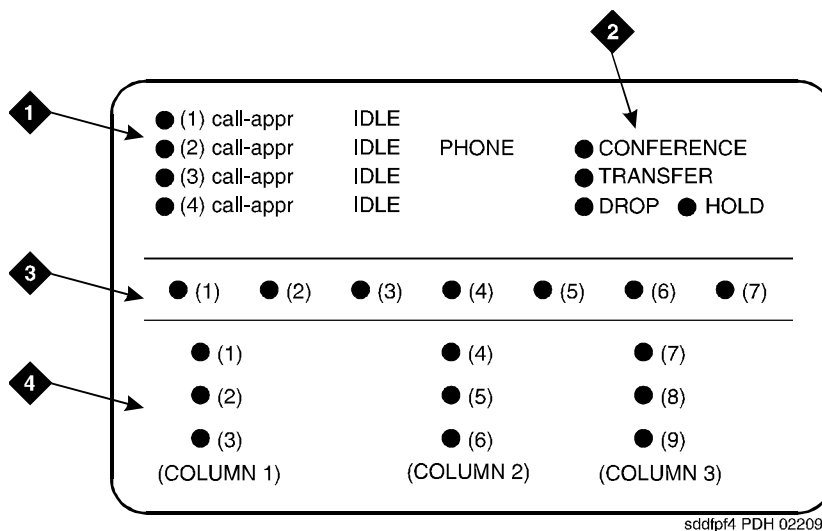

sddfp4 PDH 022097

**Figure Notes**

- 1. 4 programmable buttons
- 2. 4 fixed feature buttons

- 3. 7 display buttons
- 4. 9 feature buttons

**Figure 6-12. 510D personal terminal administrable screen button assignments**

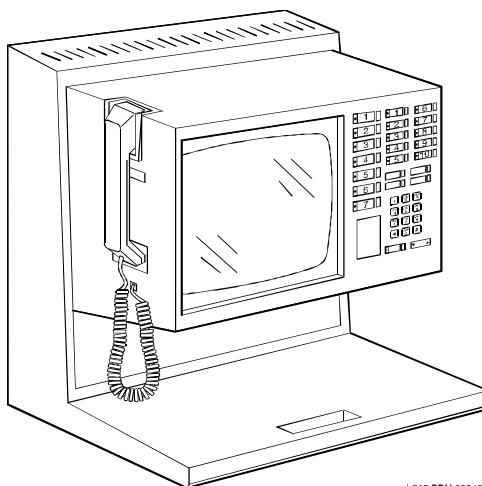

ph515 PDH 022497

**Figure 6-13. 515 business communications terminal (BCT)**

## **6402, 6402D, 6408, 6408+, 6408D, 6408D+, 6416D+, 6424D+ voice terminals**

---

The 6400-series voice terminals are DCP 2-wire voice terminals that work with DEFINITY Release 6 and future releases. 6400-series voice terminals operate similar to the 8400- and 9400-series voice terminals, although there are some enhancements, feature, and physical differences. The 6400-series voice terminals have:

- XM24 expansion module
- Different number of call appearances and feature buttons
- New defaults and features for softkeys
- Last number dialed (LND) button instead of a drop button (the drop function can be administered on any button)

The number of call appearances on a terminal is identified by the last two digits in the terminal name. The series includes two single-line sets (6402 and 6402D), 8-button sets, a 16-button set, a 24-button set, and a 24-button expansion module (on the 6416D+ and 6424D+ voice terminals).

### **To administer a 6400-series terminal**

To administer a 6400-series voice terminal, complete the standard as well as the following unique Station form fields.

For information about adjusting the system-level parameters and audio levels for the 6400-series voice terminals, see [“Terminal Parameters form” on page 6-9](#).



**On page 1 of the Station form**

```

                                     STATION
                                     Page 1 of X

Extension: 1003                      Lock Messages? n          BCC: 0
Type: 6424D+_                        Security Code: _____ TN: 1_
Port: _____                     Coverage Path 1: _____ COR: 1_
Name: _____                     Coverage Path 2: _____ COS: 1_
                                     Hunt-to Station: _____

STATION OPTIONS
    Data Module? n                    Personalized Ringing Pattern: 1
    Speakerphone: 2-way               Message Lamp Ext: 1000
    Display Language: english         Mute Button Enabled? y
                                     Expansion Module? n
                                     MM Complex Data Ext: n
  
```

**Screen 6-18. 6400 Station form (Page 1 of X)**

```

                                     Page 1 of 1

                                6400-TYPE TERMINAL PARAMETERS

Default Parameter Set:1              Customize Parameters?y

OPTIONS

    Display Mode:                    Handset Expander Enabled?
    Volume:

PRIMARY LEVELS
    Voice Transmit (dB):              Voice Sidetone (dB):
    Voice Receive (dB):              Touch Tone Sidetone (dB):
    Touch Tone Transmit (dB):

BUILT-IN SPEAKER LEVELS
    Voice Transmit (dB):              Voice Receive (dB):
    Touch Tone Sidetone (dB):

6402 BUILT-IN SPEAKER LEVELS
    Voice Receive (dB):              Touch Tone Sidetone (dB):
  
```

**Screen 6-19. 6400 Terminal Parameters form (Page 1 of 1)**

1. Enter one of the following in the `Type` field:
  - **6402** (2-line terminal that supports 1-way speakerphone)
  - **6402D** (2-line display terminal that supports 1-way speakerphone)
  - **6408** (8-line terminal that supports 1-way speakerphone)
  - **6408+** (8-line terminal that supports 2-way speakerphone)

- **6408D** (8-line display terminal that supports 1-way speakerphone)
  - **6408D+** (8-line display terminal that supports 2-way speakerphone)
  - **6416D+** (16-line display terminal that supports 2-way speakerphone)
  - **6424D+** (24-line display terminal that supports 2-way speakerphone)
2. Enter **y** in `Data Module` if this terminal is to be connected to a data terminal via a 6400 data module. If you enter **y**, you must complete the `Data Module` form. Default is **n**.
  3. Accept the default of **y** in `Mute Button Enabled?` if this terminal should have the mute button available. Enter **n** if you want to disable the mute button.
  4. Enter **y** in `Expansion Module` (for 6416D+ and 6424D+ terminals only) if a XM24 expansion module is attached to the terminal. If you enter **y**, an optional page of the form appears to allow you to administer the `Expansion Module` buttons. Default is **n**.

Page 2 of the form

Page 2 of X

| FEATURE OPTIONS                | STATION                            |
|--------------------------------|------------------------------------|
| LWC Reception? msa-spe         | Auto Select Any Idle Appearance? n |
| LWC Activation? y              | Coverage Msg Retrieval? y          |
| CDR Privacy? n                 | Auto Answer: none                  |
| Redirect Notification? y       | Data Restriction? n                |
| Per Button Ring Control? n     | Idle Appearance Preference? n      |
| Bridged Call Alerting? n       |                                    |
| Active Station Ringing: single | Restrict Last Appearance? y        |
| H.320 Conversion? n            |                                    |
| AUDIX Name: _____              | Multimedia Early Answer? n         |
| Messaging Server Name: _____   | Audible Message Waiting? y         |
|                                | Display Client Redirection? n      |
|                                | Select Last Used Appearance? n     |

Screen 6-20. 6400 Station form (Page 2 of X)

### On page 3 of the form (except 6402)

Page 3 of X

STATION

SITE DATA

|                 |                       |
|-----------------|-----------------------|
| Room: _____     | Headset? <u>n</u>     |
| Jack: _____     | Speaker? <u>n</u>     |
| Cable: _____    | Mounting: <u>d</u>    |
| Floor: _____    | Cord Length: <u>0</u> |
| Building: _____ | Set Color: _____      |

ABBREVIATED DIALING

|              |              |              |
|--------------|--------------|--------------|
| List1: _____ | List2: _____ | List3: _____ |
|--------------|--------------|--------------|

BUTTON ASSIGNMENTS

|          |          |
|----------|----------|
| 1: _____ | 5: _____ |
| 2: _____ | 6: _____ |
| 3: _____ | 7: _____ |
| 4: _____ | 8: _____ |

Screen 6-21. 6400 (except 6402) Station form (Page 3 of X)

#### ■ BUTTON ASSIGNMENTS

The feature buttons that you can assign to these voice terminals are shown in [Table 6-7](#), Button Assignments for Page 3 of the Station Form, and in the following text:

account      admin      btn-view      call-timer      group-page

### On page 3 of the 6402 form

Page 3 of X

STATION

SITE DATA

|                 |                       |
|-----------------|-----------------------|
| Room: _____     | Headset? <u>n</u>     |
| Jack: _____     | Speaker? <u>n</u>     |
| Cable: _____    | Mounting: <u>d</u>    |
| Floor: _____    | Cord Length: <u>0</u> |
| Building: _____ | Set Color: _____      |

ABBREVIATED DIALING

|              |              |              |
|--------------|--------------|--------------|
| List1: _____ | List2: _____ | List3: _____ |
|--------------|--------------|--------------|

BUTTON ASSIGNMENTS

|              |  |
|--------------|--|
| 1: call-appr |  |
| 2: call-appr |  |

Screen 6-22. 6402 Station form (Page 3 of X)

■ **BUTTON ASSIGNMENTS**

The first two buttons on the 6402 voice terminals default as call appearance buttons and cannot be changed.

**On page 4 of the form**

■ **FEATURE BUTTON ASSIGNMENTS**

The features and functions that you can assign to the terminal's administrable buttons are the same as those for BUTTON ASSIGNMENTS above.

**On page 4 of the 6402 form**

Page 4 of X

STATION

FEATURE BUTTON ASSIGNMENTS

1: \_\_\_\_\_  
2: \_\_\_\_\_  
3: \_\_\_\_\_  
4: \_\_\_\_\_  
5: \_\_\_\_\_  
6: \_\_\_\_\_  
7: \_\_\_\_\_  
8: \_\_\_\_\_  
9: \_\_\_\_\_  
\*: \_\_\_\_\_  
0: \_\_\_\_\_  
#: \_\_\_\_\_

Screen 6-23. 6402 Station form (Page 4 of X)

■ **FEATURE BUTTON ASSIGNMENTS**

The user can assign these buttons via the dial pad, or you can assign them using this form.

### On page 4 of the 6416D+ form

Page 4 of X

STATION

FEATURE BUTTON ASSIGNMENTS

9: \_\_\_\_\_  
10: \_\_\_\_\_  
11: \_\_\_\_\_  
12: \_\_\_\_\_  
13: \_\_\_\_\_  
14: \_\_\_\_\_  
15: \_\_\_\_\_  
16: \_\_\_\_\_

Screen 6-24. 6416D+ Station form (Page 4 of X)

#### ■ FEATURE BUTTON ASSIGNMENTS

These are for buttons 9 through 16.

### On page 4 of the 6424D+ form

Page 4 of X

STATION

FEATURE BUTTON ASSIGNMENTS

9: \_\_\_\_\_  
10: \_\_\_\_\_  
11: \_\_\_\_\_  
12: \_\_\_\_\_  
13: \_\_\_\_\_  
14: \_\_\_\_\_  
15: \_\_\_\_\_  
16: \_\_\_\_\_  
17: \_\_\_\_\_  
18: \_\_\_\_\_  
19: \_\_\_\_\_  
20: \_\_\_\_\_  
21: \_\_\_\_\_  
22: \_\_\_\_\_  
23: \_\_\_\_\_  
24: \_\_\_\_\_

Screen 6-25. 6424D+ Station form (Page 4 of X)

#### ■ FEATURE BUTTON ASSIGNMENTS

These are for buttons 9 through 24.

**On page 4 of the 6408D and 6408D+ forms and page 5 of the 6416D+ and 6424D+ forms**

Page 5 of X

STATION

SOFTKEY BUTTON ASSIGNMENTS

1: Dir  
 2: Drop  
 3: HFAns  
 4: Timer  
 5: PCall  
 6: AutCB  
 7: Prog  
 8: Pause  
 9: LWC  
 10: RngOf  
 11: BtnVu  
 12: Admin

**Screen 6-26. 6400 Display Station form (Page 5 of X)**

■ **SOFTKEY BUTTON ASSIGNMENTS**

The 6408D, 6408D+, 6416D+, and 6424D+ terminals support 12 display softkeys. These are the default softkeys that the system administrators:

|       |        |       |       |
|-------|--------|-------|-------|
| Dir   | Drop   | HFAns | Timer |
| PCall | AutCB  | Prog  | Pause |
| LWC   | RingOf | BtnVu | Admin |

You can assign features to these softkeys, making them “virtual” buttons. When you assign a feature to a softkey, the system automatically downloads the appropriate information to the terminal for operating the feature.

You may also customize the softkey displays for English, French, Italian, or Spanish. These are displayed in the Display Languages field on page 1 of the Station form. To customize the labels, use the Language Translation form, set Display Languages to **user-defined**, and type the command **change display-messages softkey-labels**. You may enter a five-character label for each of the softkeys.

### Page 6 of the 6416D+ or 6424D+ form

Page 6 of Y

STATION

EXPANSION MODULE BUTTON ASSIGNMENT

|           |           |
|-----------|-----------|
| 1: _____  | 13: _____ |
| 2: _____  | 14: _____ |
| 3: _____  | 15: _____ |
| 4: _____  | 16: _____ |
| 5: _____  | 17: _____ |
| 6: _____  | 18: _____ |
| 7: _____  | 19: _____ |
| 8: _____  | 20: _____ |
| 9: _____  | 21: _____ |
| 10: _____ | 22: _____ |
| 11: _____ | 23: _____ |
| 12: _____ | 24: _____ |

Screen 6-27. 6416D+ and 6424D+ with XM24 Expansion Module form (Page 6 of Y)

#### EXPANSION MODULE

This page appears only if `Expansion Module` is set to `y`. Use these pages to administer buttons on the XM24 expansion module if one is attached to the terminal.

Fields 1 through 9 on the form correspond to the 24 dual-LED feature buttons on the expansion module. You can assign to these buttons any of the features or functions that you can assign to the feature buttons referred to in the previous section, [On page 3 of the form \(except 6402\)](#).

Page X of Y of the form (DATA MODULE)

Page X of Y

STATION

DATA MODULE

Data Extension: \_\_\_\_\_ Name: \_\_\_\_\_ BCC: \_\_\_\_\_  
COS: 1\_  
COR: 1\_  
ITC: restricted TN: 1\_

ABBREVIATED DIALING  
List1: \_\_\_\_\_

SPECIAL DIALING OPTION: hot-line  
HOT LINE DESTINATION  
DEFAULT DIALING  
Abbreviated Dialing Dial Code (From above list): \_\_\_\_

ASSIGNED MEMBER (Station with a data extension button for this data module)

| Ext      | Name  |
|----------|-------|
| 1. _____ | _____ |

Screen 6-28. 6400 Data Module form (Page X of Y)

This page displays only if Data Module is y.



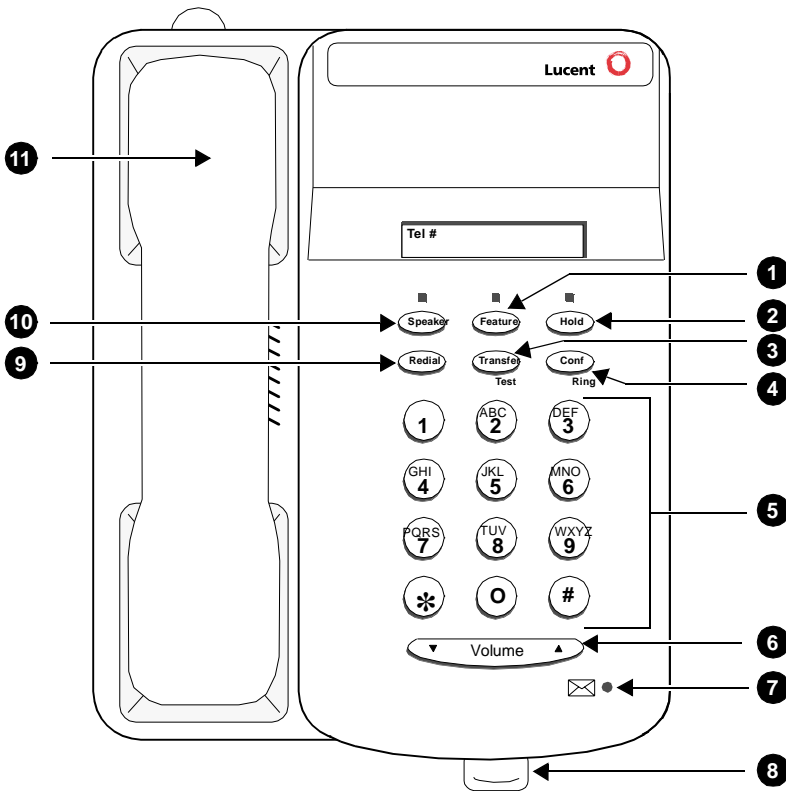

Figure Notes

- |  |   |
|--|---|
| <ul style="list-style-type: none"><li>1. Feature button</li><li>2. Hold button</li><li>3. Transfer/Test button</li><li>4. Conf/Ring button</li><li>5. Dial pad</li><li>6. Volume control button</li><li>7. Message light</li></ul> | <ul style="list-style-type: none"><li>8. Tray handle (five cards are provided in the tray located under the base of every 6400-series telephone for reference purposes)</li><li>9. Redial button</li><li>10. Speaker button</li><li>11. Handset</li></ul> |
|--|---|

Figure 6-14. 6402 Single-Line Voice Terminal

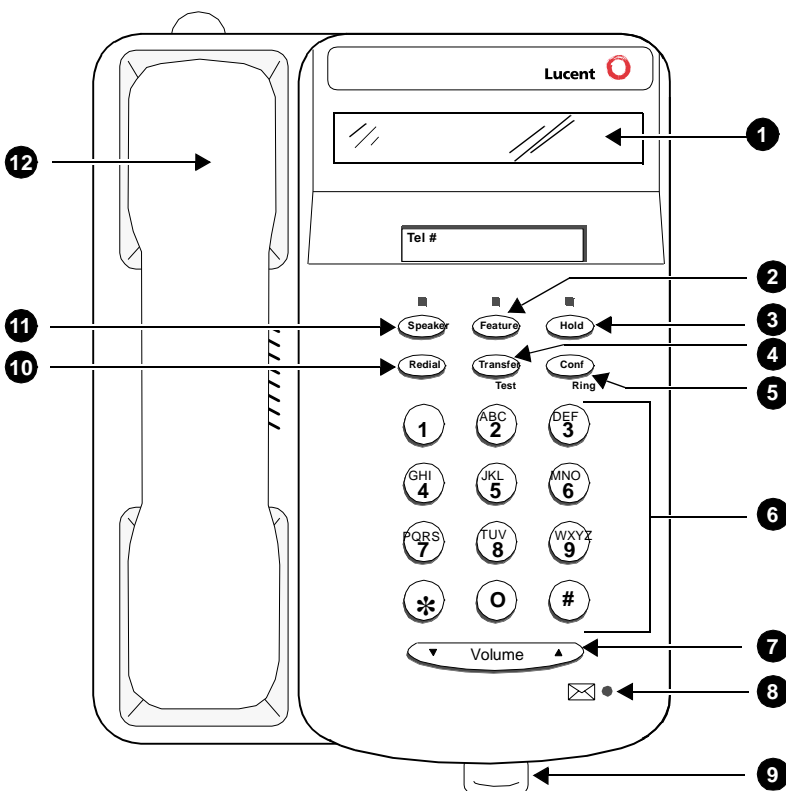
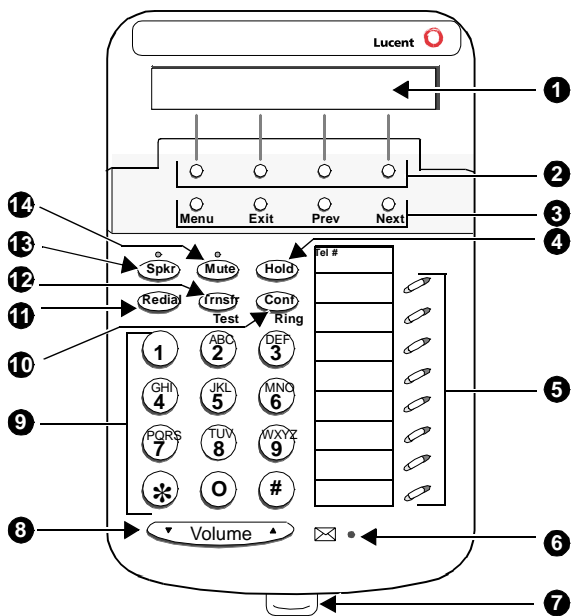

Figure Notes

- |   |  |
|---|--|
| <ul style="list-style-type: none"><li>1. Display</li><li>2. Feature button</li><li>3. Hold button</li><li>4. Transfer/Test button</li><li>5. Conf/Ring button</li><li>6. Dial pad</li><li>7. Volume control button</li><li>8. Message light</li></ul> | <ul style="list-style-type: none"><li>9. Tray handle (five cards are provided in the tray located under the base of every 6400-series telephone for reference purposes)</li><li>10. Redial button</li><li>11. Speaker button</li><li>12. Handset</li></ul> |
|---|--|

Figure 6-15. 6402D Single-Line Voice Terminal



### Figure Notes

- |   |                          |
|---|--------------------------|
| 1. Display  | 8. Volume control button |
| 2. Softkeys   | 9. Dial pad              |
| 3. Display control buttons  | 10. Conf/Ring button     |
| 4. Hold   | 11. Redial button        |
| 5. Call appearance/feature buttons  | 12. Transfer/Test button |
| 6. Message light  | 13. Speaker button       |
| 7. Tray handle (five cards are provided in the tray located under the base of every 6400-series telephone for reference purposes) | 14. Mute button          |
- Handset (not shown here)

Figure 6-16. 6408D Multi-Line Telephone

## **7302H, 7303H, and 7305H MERLIN voice terminals**

---

Administer 7302H voice terminals (5-Button) with the 7303S Station form.

Administer 7303H voice terminals (10-Button) with the 7305S Station form. Only the first 12 feature function buttons apply. Of these 12 buttons, 8 have two lamps and 4 have no lamps. However, the system treats the 8 double-lamp buttons as though they have a single (green) lamp. Administer the 4 buttons (with no lamps) with features that do not require status indications.

Administer 7305H voice terminals (34-Button) with the 7305S Station form. The system treats the terminal's 24 feature function buttons (two lamps each) as single (green) lamp function buttons.

## 7303S, 7305S, and 7309H voice terminals

---

### Form instructions

---

To administer a 7303S, 7305S, 7309S voice terminal, complete the standard as well as the following unique Station form fields.

### Page 1 of the form

|                  |                                 |             |
|------------------|---------------------------------|-------------|
|                  |                                 | Page 1 of X |
| STATION          |                                 |             |
| Extension: _____ |                                 | BCC: 0      |
| Type: 7303S_     | Lock Messages? n                | TN: 1       |
| Port: _____      | Security Code: _____            | COR: 1      |
| Name: _____      | Coverage Path 1: _____          | COS: 1      |
|                  | Coverage Path 2: _____          |             |
|                  | Hunt-to Station: _____          |             |
| STATION OPTIONS  |                                 |             |
|                  | Personalized Ringing Pattern: 1 |             |
|                  | Message Lamp Ext: _____         |             |
|                  | MM Complex Data Ext: _____      |             |

Screen 6-29. 7303S, 7305S, and 7309H Station form (Page 1 of X)

- **Type** — Enter **7303S**, **7305S**, or **7309H** as appropriate.

### Page 2 of the form

Page 2 of X

STATION

FEATURE OPTIONS

|                                |                                    |
|--------------------------------|------------------------------------|
| LWC Reception? msa-spe         | Auto Select Any Idle Appearance? n |
| LWC Activation? y              | Coverage Msg Retrieval? y          |
| CDR Privacy? n                 | Auto Answer: none                  |
| Redirect Notification? y       | Data Restriction? n                |
| Per Button Ring Control? n     | Idle Appearance Preference? n      |
| Bridged Call Alerting? n       |                                    |
| Active Station Ringing: single | Restrict Last Appearance? y        |
|                                |                                    |
| H.320 Conversion? n            |                                    |
| AUDIX Name: _____              | Multimedia Early Answer? n         |
| Messaging Server Name: _____   | Audible Message Waiting? y         |
|                                |                                    |
|                                | Select Last Used Appearance? n     |

### Screen 6-30. 7303S, 7305S, and 7309H Station form (Page 2 of X)

### Page 3 of the form

Page 3 of X

STATION

SITE DATA

|                 |                  |
|-----------------|------------------|
| Room: _____     | Headset? n       |
| Jack: _____     | Speaker? n       |
| Cable: _____    | Mounting: d      |
| Floor: _____    | Cord Length: 0_  |
| Building: _____ | Set Color: _____ |

ABBREVIATED DIALING

|              |              |              |
|--------------|--------------|--------------|
| List1: _____ | List2: _____ | List3: _____ |
|--------------|--------------|--------------|

BUTTON ASSIGNMENTS

|               |           |
|---------------|-----------|
| 1: call-appr_ | 6: _____  |
| 2: call-appr_ | 7: _____  |
| 3: call-appr_ | 8: _____  |
| 4: _____      | 9: _____  |
| 5: _____      | 10: _____ |

### Screen 6-31. 7303S, 7305S, and 7309H Station form (Page 3 of X)

■ **BUTTON ASSIGNMENTS**

The feature buttons that you can assign to the 7303S, 7305S, and 7309H voice terminals are listed below. The first 3 buttons default as call appearances.

|                        |            |            |            |
|------------------------|------------|------------|------------|
| abr-prog               | abr-spchar | abrdg-appr | abrv-dial  |
| abrv-ring              | ac-alarm   | aca-halt   | after-call |
| alrt-agchg             | alt-frl    | assist     | asvn-halt  |
| atd-qcalls             | atd-qtime  | aut-msg-wt | auto-cback |
| auto-icom              | auto-in    | autodial   | aux-work   |
| brdg-appr              | busy-ind   | call-appr  | call-fwd   |
| call-park              | call-pkup  | cas-backup | cdr1-alm   |
| cdr2-alm               | cfwd-bsyda | consult    | cov-cback  |
| data-ext               | dial-icom  | dir-pkup   | dn-dst     |
| ds1-alarm              | exclusion  | flash      | goto-cover |
| hunt-ns                | in-call-id | int-aut-an | last-numb  |
| link-alarm             | lsvn-halt  | lwc-cancel | lwc-store  |
| major-alm              | man-msg-wt | manual-in  | mct-act    |
| mct-contr              | mj/mn alrm | ringer-off | night-serv |
| noans-alrt             | per-COline | pms-alarm  | pr-awu-alm |
| pr-pms-alm             | pr-sys-alm | print-msgs | priority   |
| q-calls                | q-time     | release    | rs-alert   |
| rsvn-halt              | send-calls | send-term  | serv-obsrv |
| signal                 | ssvn-halt  | stroke-cnt | term-x-gr  |
| trk-ac-alm             | trunk-ns   | verify     | voa-repeat |
| work-code <sup>1</sup> |            |            |            |

---

1. Stations administered with displays only.

**Page 4 of the form (7305S only)**

Page 4 of 4

STATION

FEATURE BUTTON ASSIGNMENTS

|           |           |
|-----------|-----------|
| 1: _____  | 13: _____ |
| 2: _____  | 14: _____ |
| 3: _____  | 15: _____ |
| 4: _____  | 16: _____ |
| 5: _____  | 17: _____ |
| 6: _____  | 18: _____ |
| 7: _____  | 19: _____ |
| 8: _____  | 20: _____ |
| 9: _____  | 21: _____ |
| 10: _____ | 22: _____ |
| 11: _____ | 23: _____ |
| 12: _____ | 24: _____ |

**Screen 6-32. 7305S Voice-terminal form (Page 4 of 4)**

■ **FEATURE BUTTON ASSIGNMENTS**

The features and functions that you can assign on Page 4 of X are the same as those listed for BUTTON ASSIGNMENTS above.



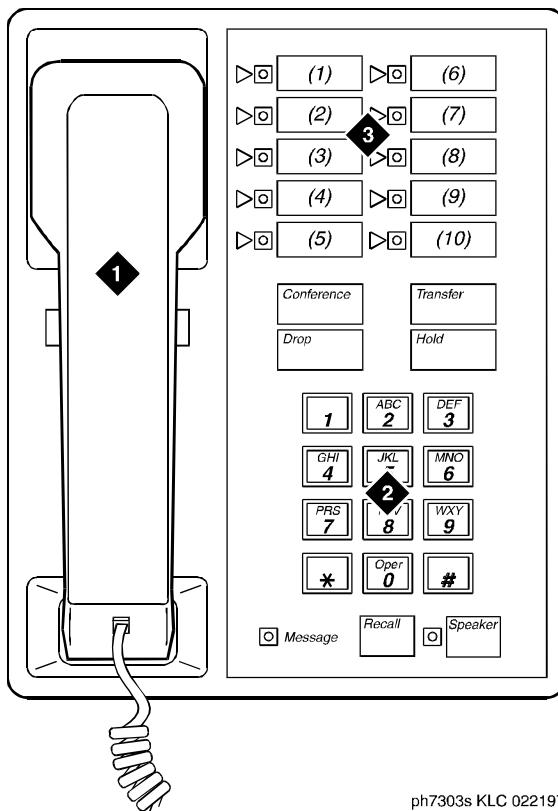

ph7303s KLC 022197

Figure Notes

- 1. Handset
- 2. Dial pad

- 3. 10 programmable buttons

Figure 6-17. 7303S voice terminal

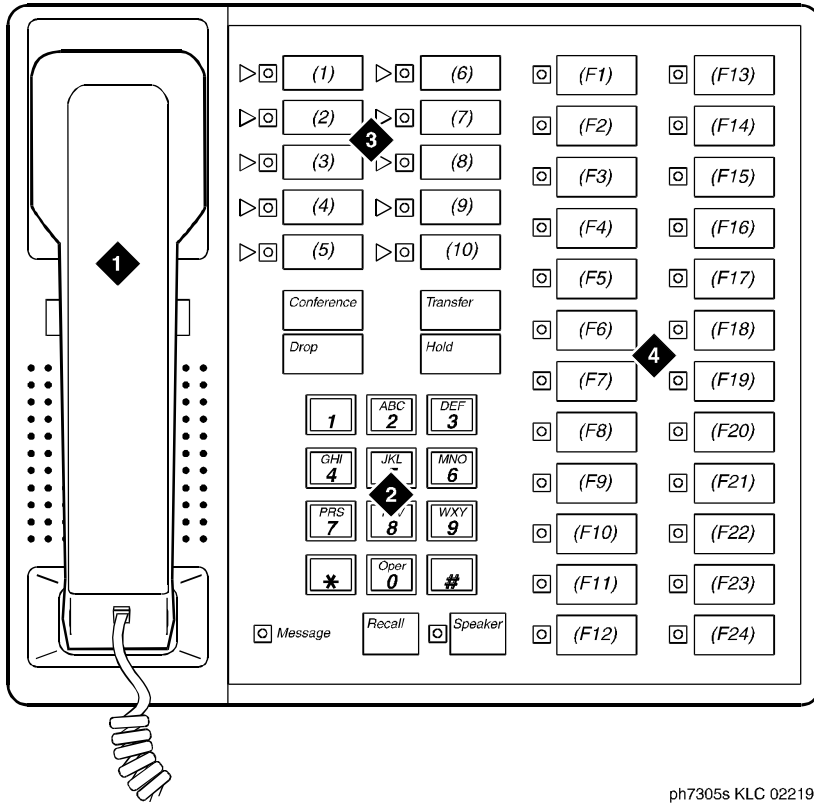

ph7305s KLC 022197

Figure Notes

- 1. Handset
- 2. Dial pad

- 3. 10 programmable buttons
- 4. 24 feature buttons

Figure 6-18. 7305S voice terminal

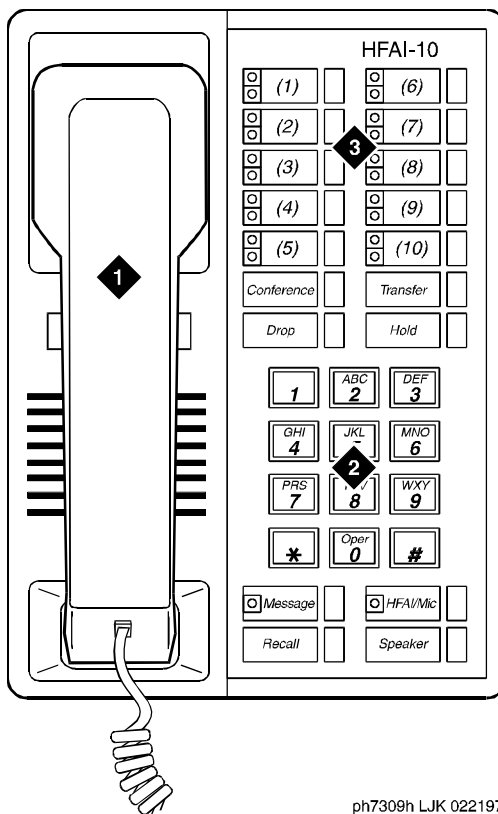

ph7309h LJK 022197

Figure Notes

- 1. Handset
- 2. Dial pad

- 3. 10 programmable buttons with in-use and status LEDs

Figure 6-19. 7309H voice terminal

## **7313H, 7314H, 7315H, 7316H, and 7317H voice terminals**

The following feature differences and restrictions exist for hybrid voice terminals in the system:

- Hybrid voice terminals equipped with displays cannot be used as ACD agents.
- The following feature buttons do not operate on Hybrid terminals: STOP, PAUSE, RECALL, MESSAGE, HFAL, and HFAL/MIC. The replacement for Hands Free Automatic Answer on Intercom (HFAL) is Internal Automatic Answer (IAA).
- When administering IAA on a 731xH series voice terminal, you should assign a feature button with a lamp so the lamp status of IAA can be observed.



**NOTE:**

When placing a call to pager equipment, do not immediately hang up when finished dialing until receipt of confirmation. Failure to wait for confirmation may result in an incomplete signal being sent to the pager resulting in an incomplete call message.

### **Form instructions**

To administer a 7313H (BIS-10), 7314H (BIS-22), 7315H (BIS-22D), 7316H (BIS-34), or 7317H (BIS-34D) voice terminal, complete the standard as well as the following unique Station form fields.

### **Page 1 of the form**

Page 1 of X

| STATION           |                                 |                            |
|-------------------|---------------------------------|----------------------------|
| Extension: 1003   | Lock Messages? n                | BCC: 0                     |
| Type: 7315H__     | Security Code: _____            | TN: 1__                    |
| Port: _____       | Coverage Path 1: _____          | COR: 1__                   |
| Name: _____       | Coverage Path 2: _____          | COS: 1__                   |
|                   | Hunt-to Station: _____          |                            |
| STATION OPTIONS   |                                 |                            |
| Display Module? y | Personalized Ringing Pattern: 1 | Message Lamp Ext: 1000__   |
|                   |                                 | MM Complex Data Ext: _____ |

**Screen 6-33. 7313H, 7314H, 7315H, 7316H, and 7317H Station form (Page 1 of X)**

- **Type** — Enter **7313H, 7314H, 7315H, 7316H,** or **7317H** as appropriate.

## Page 2 of the form

| FEATURE OPTIONS          |         | STATION                          | Page 2 of X |
|--------------------------|---------|----------------------------------|-------------|
| LWC Reception?           | msa-spe | Auto Select Any Idle Appearance? | n           |
| LWC Activation?          | y       | Coverage Msg Retrieval?          | y           |
| CDR Privacy?             | n       | Auto Answer:                     | none        |
| Redirect Notification?   | y       | Data Restriction?                | n           |
| Per Button Ring Control? | n       | Idle Appearance Preference?      | n           |
| Bridged Call Alerting?   | n       | Restrict Last Appearance?        | y           |
| Active Station Ringing:  | single  |                                  |             |
| H.320 Conversion?        | n       | Multimedia Early Answer?         | n           |
| AUDIX Name:              | _____   | Audible Message Waiting?         | y           |
| Messaging Server Name:   | _____   | Display Client Redirection?      | n           |
|                          |         | Select Last Used Appearance?     | n           |

Screen 6-34. 7313H, 7314H, 7315H, 7316H, and 7317H Station form (Page 2 of X)

## Page 3 of the form

### ■ BUTTON ASSIGNMENTS

The feature buttons that you can assign to the 7313H, 7314H, 7315H, 7316H, and 7317H voice terminals are listed below. The first three button assignments may only be call appearance. The abrdg-appr, brdg-appr and call-appr buttons can only be assigned to button numbers 1 through 10 on this page of the form. Button assignments 1 through 10 correspond to the first and second columns of buttons on the voice terminal.

|                         |                         |                         |                         |
|-------------------------|-------------------------|-------------------------|-------------------------|
| abr-prog                | abr-spchar              | abrdg-appr              | abrv-dial               |
| abrv-ring               | ac-alarm                | aca-halt                | after-call              |
| alrt-agchg              | alt-frl                 | assist                  | asvn-halt               |
| atd-qcalls              | atd-qtime               | aut-msg-wt              | auto-cback              |
| auto-icom               | auto-in                 | auto-wkup <sup>2</sup>  | autodial                |
| aux-work                | brdg-appr               | busy-ind                | call-appr               |
| call-disp <sup>2</sup>  | call-fwd                | call-park               | call-pkup               |
| callr-info <sup>2</sup> | cas-backup              | cdr1-alm                | cdr2-alm                |
| cfwd-bsyda              | check-in <sup>2</sup>   | check-out <sup>2</sup>  | clk-overid <sup>2</sup> |
| consult                 | cov-cback               | cov-msg-rt <sup>2</sup> | data-ext                |
| date-time <sup>2</sup>  | delete-msg <sup>2</sup> | dial-icom               | directory <sup>2</sup>  |
| disp-chrg <sup>2</sup>  | disp-norm <sup>2</sup>  | dn-dst                  | ds1-alarm               |
| exclusion               | ext-dn-dst <sup>2</sup> | flash                   | goto-cover              |
| grp-dn-dst <sup>2</sup> | hunt-ns                 | in-call-id              | inspect <sup>2</sup>    |
| int-aut-an <sup>1</sup> | last-numb               | link-alarm              | lsvn-halt               |
| lwc-cancel              | lwc-lock <sup>2</sup>   | lwc-store               | major-alm               |
| man-msg-wt              | man-overid <sup>2</sup> | manual-in               | mct-act                 |
| mct-contr               | mj/mn alm               | msg-retr <sup>2</sup>   | mwn-act <sup>2</sup>    |
| mwn-deact <sup>2</sup>  | next <sup>2</sup>       | night-serv              | noans-alrt              |
| normal <sup>2</sup>     | per-COline              | pms-alarm               | pr-awu-alm              |
| pr-pms-alm              | pr-sys-alm              | print-msgs              | priority                |
| q-calls                 | q-time                  | release                 | ringer-off              |
| rs-alert                | rsvn-halt               | scroll <sup>2</sup>     | send-calls              |
| send-term               | serv-obsrv              | signal                  | ssvn-halt               |
| stored-num <sup>2</sup> | stroke-cnt              | term-x-gr               | timer <sup>2</sup>      |
| trk-ac-alm              | trk-id <sup>2</sup>     | trunk-name <sup>2</sup> | trunk-ns                |
| verify                  | voa-repeat              | vu-display <sup>2</sup> | work-code <sup>3</sup>  |

- 
1. Administrable on 731xH and 730xH stations administered as 731xH stations.
  2. Administrable on 7315H and 7317H stations only.
  3. Stations administered with displays only.

### Page 3 of the form

(7314H, 7315H, 7316H, and 7317H only)

Page 3 of X

|                     |              |                           |
|---------------------|--------------|---------------------------|
| SITE DATA           |              | STATION                   |
| Room: _____         |              | Headset? n                |
| Jack: _____         |              | Speaker? n                |
| Cable: _____        |              | Mounting: d               |
| Floor: _____        |              | Cord Length: 0_           |
| Building: _____     |              | Set Color: _____          |
|                     |              |                           |
| ABBREVIATED DIALING | List1: _____ | List2: _____ List3: _____ |
|                     |              |                           |
| BUTTON ASSIGNMENTS  |              |                           |
| 1: call-appr_       |              | 6: _____                  |
| 2: call-appr_       |              | 7: _____                  |
| 3: call-appr_       |              | 8: _____                  |
| 4: _____            |              | 9: _____                  |
| 5: _____            |              | 10: _____                 |

### Screen 6-35. 7313H, 7314H, 7315H, 7316H, and 7317H Station form (Page 3 of X)

#### ■ FEATURE BUTTON ASSIGNMENTS

The features and functions that you can assign to the 7314H, 7315H, 7316H, and 7317H on Page 3 of the form are the same as those listed for BUTTON ASSIGNMENTS above. For the 7314H and 7315H, only buttons 1 through 12 display and correspond to the third column of buttons on the voice terminal. For the 7316H and 7317H, buttons 1 through 24 correspond to the third and fourth columns of buttons.

**Page 4 of the form**

Page 4 of 4

STATION

FEATURE BUTTON ASSIGNMENTS

|           |           |
|-----------|-----------|
| 1: _____  | 13: _____ |
| 2: _____  | 14: _____ |
| 3: _____  | 15: _____ |
| 4: _____  | 16: _____ |
| 5: _____  | 17: _____ |
| 6: _____  | 18: _____ |
| 7: _____  | 19: _____ |
| 8: _____  | 20: _____ |
| 9: _____  | 21: _____ |
| 10: _____ | 22: _____ |
| 11: _____ | 23: _____ |
| 12: _____ | 24: _____ |

**Screen 6-36. 7314H, 7315H, 7316H, and 7317H Station form (Page 4 of 4)**



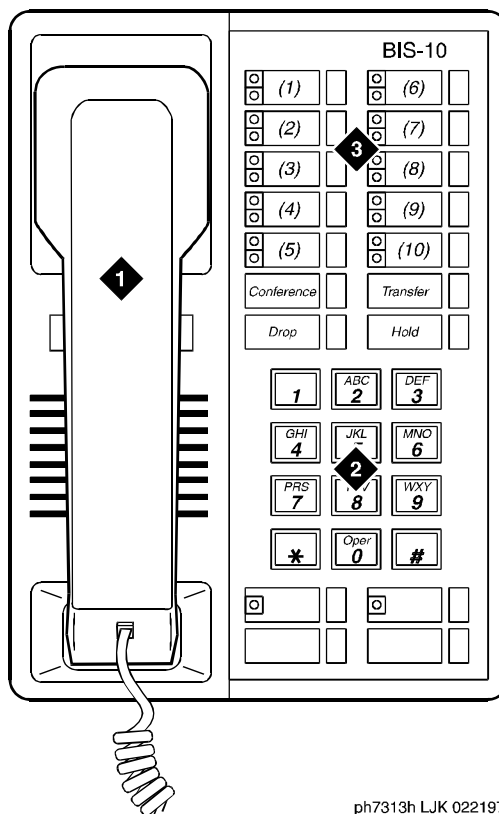

ph7313h LJK 022197

Figure Notes

- 1. Handset
- 2. Dial pad

- 3. 10 programmable buttons

Figure 6-20. 7313H voice terminal (BIS 10)

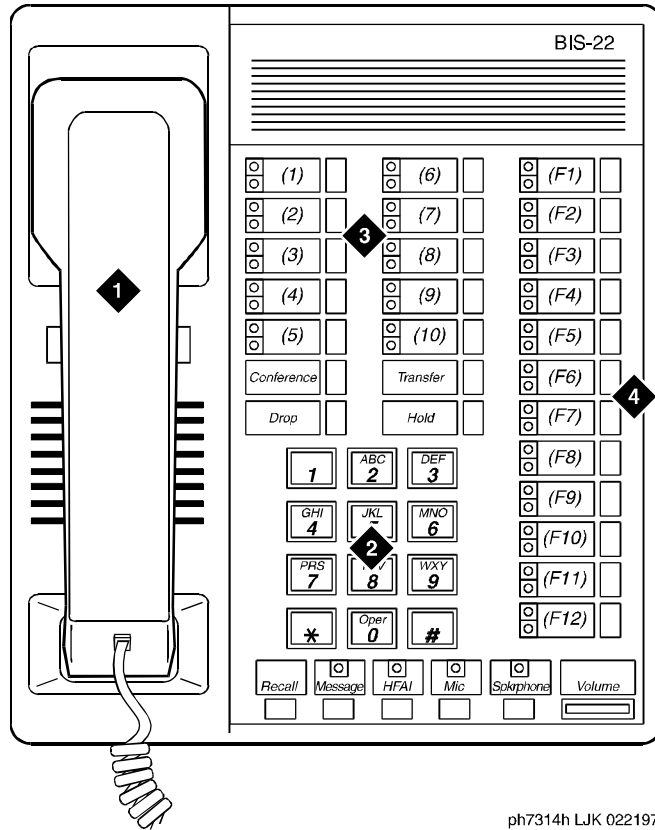

ph7314h LJK 022197

Figure Notes

- 1. Handset
- 2. Dial pad

- 3. 10 programmable buttons
- 4. 12 feature buttons

Figure 6-21. 7314H voice terminal (BIS 22)

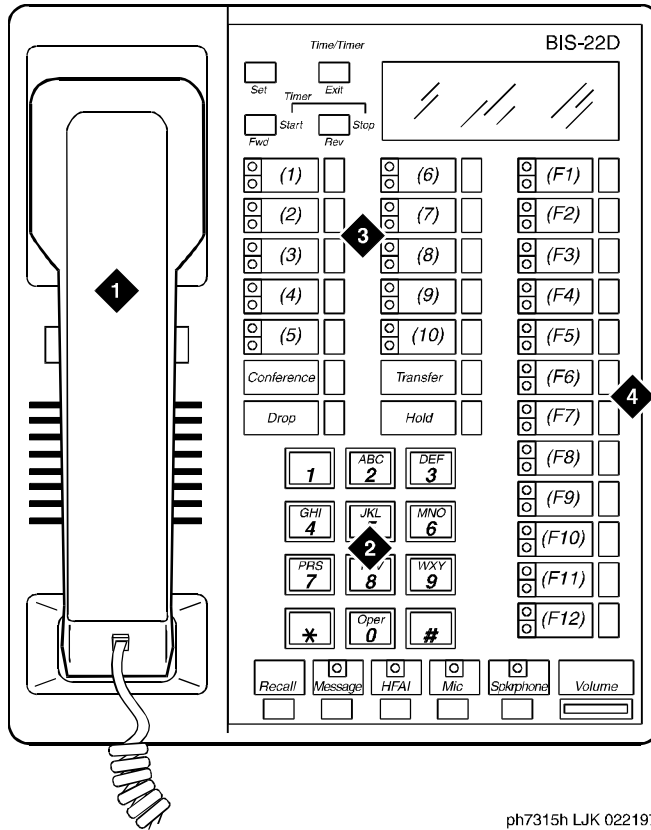

ph7315h LJK 022197

Figure Notes

- 1. Handset
- 2. Dial pad
- 3. 10 programmable buttons
- 4. 12 feature buttons

Figure 6-22. 7315H voice terminal (BIS 22D)

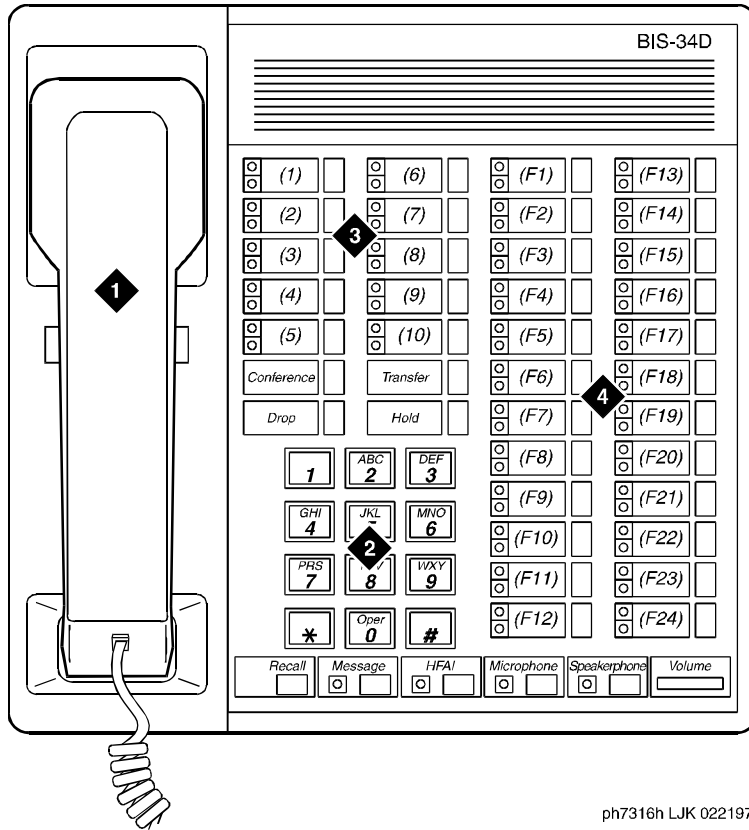

ph7316h LJK 022197

Figure Notes

- 1. Handset
- 2. Dial pad
- 3. 10 programmable buttons
- 4. 24 feature buttons

Figure 6-23. 7316H voice terminal (BIS 34)

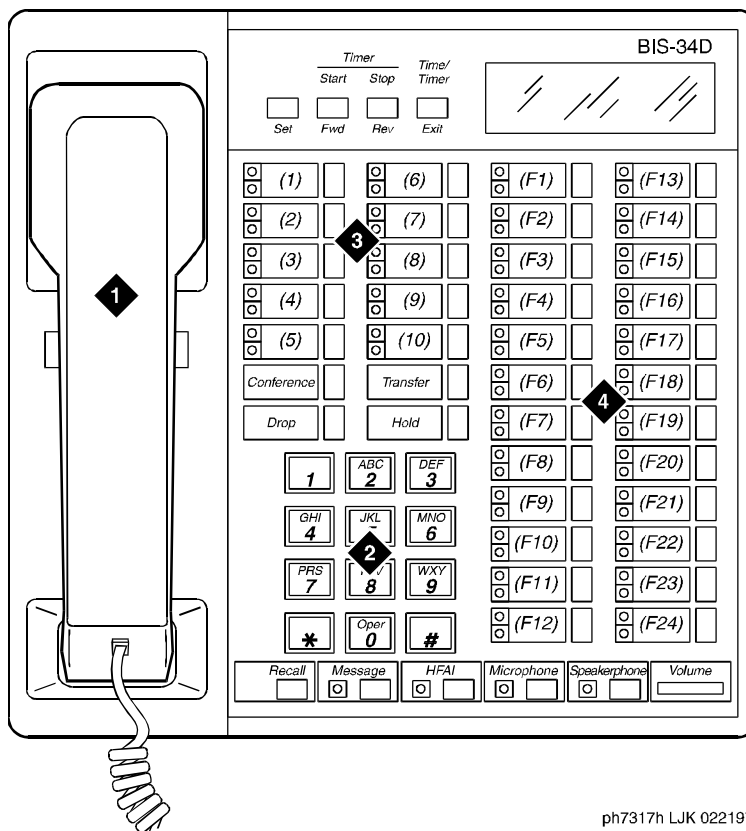

ph7317h LJK 022197

Figure Notes

- |             |                            |
|-------------|----------------------------|
| 1. Handset  | 3. 10 programmable buttons |
| 2. Dial pad | 4. 24 feature buttons      |

Figure 6-24. 7317H voice terminal (BIS 34D)

## 7401D, 7401+, 7403D, 7404D, 7410D, and 7410+ voice terminals

### Form instructions

To administer a 7401D, 7401+, 7403D, 7404D, 7410D, or 7410+ voice terminal, complete the standard as well as the following unique Station form fields.

### Page 1 of the form

Page 1 of X

STATION

|                 |                        |         |
|-----------------|------------------------|---------|
| Extension: 1003 | Lock Messages? n       | BCC: 0  |
| Type: 7401D__   | Security Code: _____   | TN: 1_  |
| Port: _____     | Coverage Path 1: _____ | COR: 1_ |
| Name: _____     | Coverage Path 2: _____ | COS: 1_ |
|                 | Hunt-to Station: _____ |         |

STATION OPTIONS

|                |                                 |
|----------------|---------------------------------|
| Data Module? n | Personalized Ringing Pattern: 1 |
|                | Message Lamp Ext: 1000          |
|                | MM Complex Data Ext: _____      |

Screen 6-37. 7401D and 7401+ Station form (Page 1 of X)

Page 1 of X

STATION

|                 |                        |         |
|-----------------|------------------------|---------|
| Extension: 1003 | Lock Messages? n       | BCC: 0  |
| Type: 7403D__   | Security Code: _____   | TN: 1_  |
| Port: _____     | Coverage Path 1: _____ | COR: 1_ |
| Name: _____     | Coverage Path 2: _____ | COS: 1_ |
|                 | Hunt-to Station: _____ |         |

STATION OPTIONS

|                |                            |
|----------------|----------------------------|
| Data Module? n | Message Lamp Ext: 1000     |
|                | MM Complex Data Ext: _____ |

Screen 6-38. 7403D, 7410D, and 7401+ Station form (Page 1 of X)

```

                                                    Page 1 of X
                                STATION

Extension: 1003                                Lock Messages? n                BCC: 0
Type: 7404D__                                Security Code: _____      TN: 1_
Port: _____                            Coverage Path 1: _____    COR: 1_
Name: _____                            Coverage Path 2: _____    COS: 1_
                                           Hunt-to Station: _____

STATION OPTIONS
    Data Module? y                            Personalized Ringing Pattern: 1
    Display Module? y                        Message Lamp Ext: 1000
    Display Language: english                Display Cartridge? n
                                           MM Complex Data Ext: _____
    
```

Screen 6-39. 7404D Station form (Page 1 of X)

- **Type** — Enter **7401D**, **7401+**, **7403D**, **7404D**, **7410D**, or **7410+** as appropriate.
- **Data Module** — For the 7401D, 7401+, 7410D, and 7410+, enter **y** if this terminal is to connect to a data terminal via a 7400B or 8400B Data Module. For the 7403D, enter **y** if this terminal is to connect to a data terminal via optional digital terminal data module (DTDM), 7400B, or 8400B Data Module. For the 7404D, this is a display-only field set to **y**. If **y** is entered, you must complete the Data Module form. Default is **n**.

Page 2 of the form

```

                                                    Page 2 of X
                                STATION

FEATURE OPTIONS
    LWC Reception? msa-spe                    Auto Select Any Idle Appearance? n
    LWC Activation? y                        Coverage Msg Retrieval? y
    CDR Privacy? n                          Auto Answer: none
    Redirect Notification? y                  Data Restriction? n
    Per Button Ring Control? n                Idle Appearance Preference? n
    PCOL/TEG Call Alerting? n                Restrict Last Appearance? y
    Active Station Ringing: single

    H.320 Conversion? n                      Multimedia Early Answer? n
    AUDIX Name: _____                    Audible Message Waiting? y
    Messaging Server Name: _____          Select Last Used Appearance? n
    
```

Screen 6-40. 7401D and 7401+ Station form (Page 2 of X)

Page 2 of X

| FEATURE OPTIONS                | STATION                            |
|--------------------------------|------------------------------------|
| LWC Reception? msa-spe         | Auto Select Any Idle Appearance? n |
| LWC Activation? y              | Coverage Msg Retrieval? y          |
| CDR Privacy? n                 | Auto Answer: none                  |
| Redirect Notification? y       | Data Restriction? n                |
| Per Button Ring Control? n     | Idle Appearance Preference? n      |
| Bridged Call Alerting? n       |                                    |
| Active Station Ringing: single | Restrict Last Appearance? y        |
|                                |                                    |
| H.320 Conversion? n            |                                    |
| AUDIX Name: _____              | Multimedia Early Answer? n         |
| Messaging Server Name: _____   | Audible Message Waiting? y         |
|                                |                                    |
|                                | Select Last Used Appearance? n     |

Screen 6-41. 7403D, 7410D, and 7401+ Station form (Page 2 of X)

Page 2 of X

| FEATURE OPTIONS                | STATION                            |
|--------------------------------|------------------------------------|
| LWC Reception? msa-spe         | Auto Select Any Idle Appearance? n |
| LWC Activation? y              | Coverage Msg Retrieval? y          |
| CDR Privacy? n                 | Auto Answer: none                  |
| Redirect Notification? y       | Data Restriction? n                |
| Per Button Ring Control? n     | Idle Appearance Preference? n      |
| Bridged Call Alerting? n       |                                    |
| Active Station Ringing: single | Restrict Last Appearance? y        |
|                                |                                    |
| H.320 Conversion? n            |                                    |
| AUDIX Name: _____              | Multimedia Early Answer? n         |
| Messaging Server Name: _____   | Audible Message Waiting? y         |
|                                | Display Client Redirection? n      |
|                                | Select Last Used Appearance? n     |

Screen 6-42. 7404D Station form (Page 2 of X)

- **Display Module** — Enter **y** if the 7404D voice terminal is to have a display via a 7400B or 8400B Data Module and associated data terminal or an optional Messaging Cartridge (7404D only) and an associated data terminal. If you enter **y**, you must complete `Display Language` and the `Display Button Assignments` form. Default is **n**.



Page 3 of the form

Page 3 of X

STATION

SITE DATA

|                 |                  |
|-----------------|------------------|
| Room: _____     | Headset? n       |
| Jack: _____     | Speaker? n       |
| Cable: _____    | Mounting: d      |
| Floor: _____    | Cord Length: 0   |
| Building: _____ | Set Color: _____ |

ABBREVIATED DIALING

|              |              |              |
|--------------|--------------|--------------|
| List1: _____ | List2: _____ | List3: _____ |
|--------------|--------------|--------------|

BUTTON ASSIGNMENTS

|               |          |
|---------------|----------|
| 1: call-appr_ | 6: _____ |
| 2: call-appr_ | 7: _____ |
| 3: _____      | 8: _____ |
| 4: _____      | 9: _____ |
| 5: _____      |          |

Screen 6-43. 7401D and 7401+ Station form (Page 3 of X)

Page 3 of X

STATION

SITE DATA

|                 |                  |
|-----------------|------------------|
| Room: _____     | Headset? n       |
| Jack: _____     | Speaker? n       |
| Cable: _____    | Mounting: d      |
| Floor: _____    | Cord Length: 0   |
| Building: _____ | Set Color: _____ |

ABBREVIATED DIALING

|              |              |              |
|--------------|--------------|--------------|
| List1: _____ | List2: _____ | List3: _____ |
|--------------|--------------|--------------|

BUTTON ASSIGNMENTS

|               |           |
|---------------|-----------|
| 1: call-appr_ | 6: _____  |
| 2: call-appr_ | 7: _____  |
| 3: call-appr_ | 8: _____  |
| 4: _____      | 9: _____  |
| 5: _____      | 10: _____ |

Screen 6-44. 7403D, 7410D, and 7410+ Station form (Page 3 of X)

Page 3 of X

STATION

SITE DATA

|                 |                  |
|-----------------|------------------|
| Room: _____     | Headset? n       |
| Jack: _____     | Speaker? n       |
| Cable: _____    | Mounting: d      |
| Floor: _____    | Cord Length: 0_  |
| Building: _____ | Set Color: _____ |

ABBREVIATED DIALING

|              |              |              |
|--------------|--------------|--------------|
| List1: _____ | List2: _____ | List3: _____ |
|--------------|--------------|--------------|

BUTTON ASSIGNMENTS

|               |          |
|---------------|----------|
| 1: call-appr_ | 4: _____ |
| 2: call-appr_ | 5: _____ |
| 3: call-appr_ | 6: _____ |

Screen 6-45. 7404D Station form (Page 3 of X)

- **Headset** — For a 7401D or 7404D, enter n, these terminals cannot have a headset. For a 7403D, enter y if the terminal is to have a headset. Default is n.

- **BUTTON ASSIGNMENTS**

The feature buttons that you can assign to the 7401D, 7401+, 7403D, 7404D, 7410D, or 7410+ voice terminals are listed below. For 7401D and 7401+, only buttons 1 through 9 display. Buttons 1 and 2 are assigned as call-appr. Buttons 3 through 9 are used to assign features to dial pad keys 1 through 7. For 7403D, 7404D, 7410D, and 7410+ voice terminals, the 3 three buttons default as call appearance buttons.

|                       |            |                         |            |
|-----------------------|------------|-------------------------|------------|
| abr-prog              | abr-spchar | abrdg-app <sup>1</sup>  | abrv-dial  |
| abrv-ring             | ac-alarm   | aca-halt                | after-call |
| alrt-agchg            | alt-frl    | assist                  | asvn-halt  |
| atd-qcalls            | atd-qtime  | aut-msg-wt              | auto-cback |
| auto-icom             | auto-in    | autodial                | aux-work   |
| brdg-app <sup>1</sup> | busy-ind   | call-app <sup>1</sup>   | call-fwd   |
| call-park             | call-pkup  | cas-backup              | cdr1-alm   |
| cdr2-alm              | cfwd-bsyda | consult                 | cov-cback  |
| data-ext              | dial-icom  | dir-pkup                | dn-dst     |
| ds1-alarm             | exclusion  | flash                   | goto-cover |
| hunt-ns               | in-call-id | int-aut-an <sup>2</sup> | last-numb  |
| link-alarm            | lsvn-halt  | lwc-cancel              | lwc-store  |
| major-alm             | man-msg-wt | manual-in               | mct-act    |
| mct-contr             | mf-da-intl | mf-op-intl              | mj/mn alm  |
| night-serv            | noans-alrt | per-COline              | pms-alarm  |
| pr-awu-alm            | pr-pms-alm | pr-sys-alm              | print-msgs |
| priority              | q-calls    | q-time                  | release    |
| ringer-off            | rs-alert   | rsvn-halt               | send-calls |
| send-term             | serv-obsrv | signal                  | ssvn-halt  |
| stroke-cnt            | term-x-gr  | trk-ac-alm              | trunk-ns   |
| verify                | voa-repeat | work-code <sup>2</sup>  |            |

- 
1. Not administrable on the 7401D or 7401+ voice terminal.
  2. Available only on 7403D, 7404D, 7410D, and 7410+.

## Page 4 of the form

|                            |             |
|----------------------------|-------------|
| DISPLAY BUTTON ASSIGNMENTS | Page 4 of X |
| 1: _____                   |             |
| 2: _____                   |             |
| 3: _____                   |             |
| 4: _____                   |             |
| 5: _____                   |             |
| 6: _____                   |             |
| 7: _____                   |             |

### 7404D Display Button Assignments form (Page 4 of X)

#### Page X of the form DISPLAY BUTTON ASSIGNMENTS)

This page displays only if `Display` is set to **y** (7404D only). The display function is obtained via an optional Messaging Cartridge and an associated data terminal (also requires administering the Data Module form).

When you administer buttons 1 through 7, they relate to function buttons (F1-F7) on the associated data terminal.

#### Page X of the form (DATA MODULE)

This page displays only if `Data Module` is **y**.

|   |             |             |
|---|-------------|-------------|
| DATA MODULE   | STATION     | Page Y of X |
| Data Extension: _____   | Name: _____ | BCC: 2      |
|   | COS: 1_     |             |
|   | COR: 1_     |             |
| ITC: restricted   | TN: 1_      |             |
| ABBREVIATED DIALING   |             |             |
| List1: _____  |             |             |
| SPECIAL DIALING OPTION: hot-line  |             |             |
| HOT LINE DESTINATION  |             |             |
| DEFAULT DIALING   |             |             |
| Abbreviated Dialing Dial Code (From above list): ____                       |             |             |
| ASSIGNED MEMBER (Station with a data extension button for this data module) |             |             |
| Ext   | Name        |             |
| 1. _____  | _____       |             |

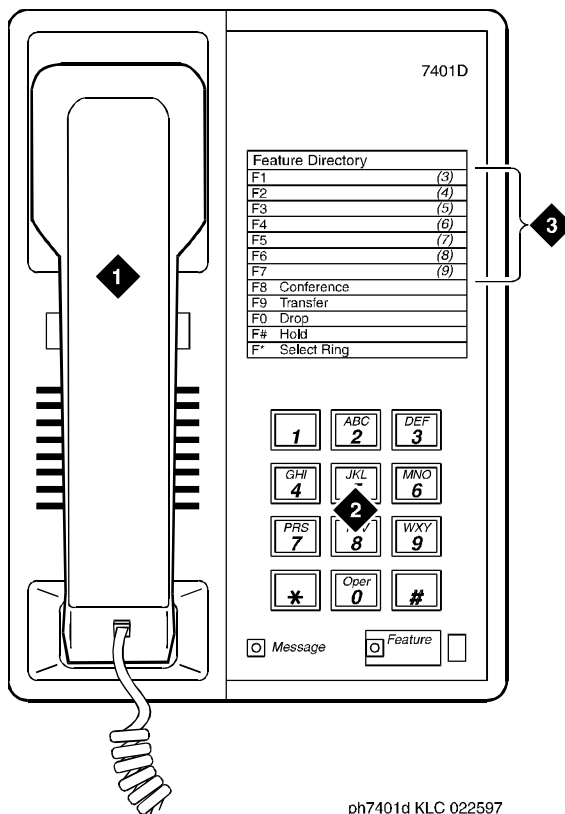

ph7401d KLC 022597

Figure Notes

- 1. Handset
- 2. Dial pad

- 3. Access codes card

Figure 6-25. 7401D voice terminal

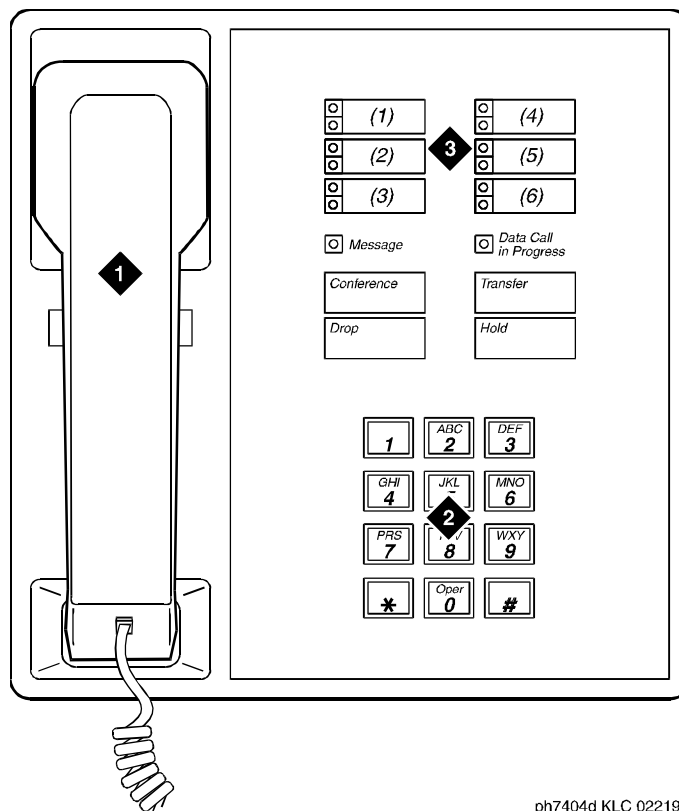

ph7404d KLC 022197

Figure Notes

- 1. Handset
- 2. Dial pad

- 3. 6 programmable buttons

Figure 6-26. 7404D voice terminal

## 7405D voice terminal

### Form instructions

To administer a 7405D voice terminal, complete the standard as well as the following unique Station form fields.

### Page 1 of the form

|                           |                        |                            |
|---------------------------|------------------------|----------------------------|
|                           |                        | Page 1 of X                |
| STATION                   |                        |                            |
| Extension: 1003           | Lock Messages? n       | BCC: 0                     |
| Type: 7405D__             | Security Code: _____   | TN: 1_                     |
| Port: _____               | Coverage Path 1: _____ | COR: 1_                    |
| Name: _____               | Coverage Path 2: _____ | COS: 1_                    |
|                           | Hunt-to Station: _____ |                            |
| STATION OPTIONS           |                        |                            |
| Data Module? y            |                        | Message Lamp Ext: 1000     |
| Display Module? y         |                        | Feature Module? n          |
| Display Language: english |                        | Coverage Module? n         |
|                           |                        | MM Complex Data Ext: _____ |

### Screen 6-47. 7405D Station form (Page 1 of X)

- **Type** — Enter **7405D**.
- **Data Module** — Enter **y** if this terminal is connected to an optional digital terminal data module (DTDM). If you enter **y**, you must complete the Data Module form. Default is **n**.
- **Feature Module** — Enter **y** if the voice terminal is to connect to an optional Feature Module. If you enter **y**, you must complete the Feature Module form. Default is **n**.
- **Display Module** — Enter **y** if the voice terminal is to have a display by an optional Digital Display Module. If you enter **y**, you must complete the Display Button assignments form. Default is **n**.
- **Coverage Module** — Enter **y** if the voice terminal is to connect to an optional Call Coverage Module. If you enter **y**, you must complete the Coverage Module form. The voice terminal cannot have an optional Coverage Module and optional Digital Display Module at the same time. Default is **n**.

### Page 2 of the form

```

                                                                 Page 2 of X
                                STATION
FEATURE OPTIONS
    LWC Reception? msa-spe          Auto Select Any Idle Appearance? n
    LWC Activation? y              Coverage Msg Retrieval? y
    CDR Privacy? n                Auto Answer: none
    Redirect Notification? y       Data Restriction? n
    Per Button Ring Control? n    Idle Appearance Preference? n
    Bridged Call Alerting? n
    Active Station Ringing: single Restrict Last Appearance? y

    H.320 Conversion? n
    AUDIX Name: _____        Multimedia Early Answer? n
    Messaging Server Name: _____ Audible Message Waiting? y
                                    Display Client Redirection? n
                                    Select Last Used Appearance? n
```

Screen 6-48. 7405D Station form (Page 2 of X)

### Page 3 of the form

```

                                                                 Page 3 of X
                                STATION
SITE DATA
    Room: _____              Headset? n
    Jack: _____              Speaker? n
    Cable: _____             Mounting: d
    Floor: _____             Cord Length: 0_
    Building: _____          Set Color: _____

ABBREVIATED DIALING
    List1: _____            List2: _____            List3: _____

BUTTON ASSIGNMENTS
    1: call-appr_              6: _____
    2: call-appr_              7: _____
    3: call-appr_              8: _____
    4: _____                9: _____
    5: _____                10: _____
```

Screen 6-49. 7405D Station form (Page 3 of X)



■ **BUTTON ASSIGNMENTS**

The feature buttons that you can assign to the 7405D voice terminal are listed below. For 7405D voice terminals, the first 3 buttons default as call appearances. The 7405D voice terminal can have an optional Function Key Module (administered as a Feature Module), Digital Display Module, and Coverage Module, respectively.

|                         |                         |                         |                         |
|-------------------------|-------------------------|-------------------------|-------------------------|
| abr-prog                | abr-spchar              | abrdg-appr              | abrv-dial               |
| abrv-ring               | ac-alarm                | aca-halt                | after-call              |
| alrt-agchg              | alt-frl                 | assist                  | asvn-halt               |
| atd-qcalls <sup>1</sup> | atd-qtime <sup>1</sup>  | aut-msg-wt              | auto-cback              |
| auto-icom               | auto-in                 | auto-wkup <sup>1</sup>  | autodial                |
| aux-work                | brdg-appr <sup>2</sup>  | busy-ind                | call-appr <sup>2</sup>  |
| call-disp <sup>1</sup>  | call-fwd                | call-park               | call-pkup               |
| callr-info <sup>1</sup> | cas-backup              | cdr1-alm                | cdr2-alm                |
| cfwd-bsyda              | check-in <sup>1</sup>   | check-out <sup>1</sup>  | clk-overid <sup>1</sup> |
| consult                 | cov-cback               | cov-msg-rt <sup>1</sup> | data-ext                |
| date-time <sup>1</sup>  | delete-msg <sup>1</sup> | dial-icom               | directory <sup>1</sup>  |
| dir-pkup                | disp-chrg               | disp-norm               | dn-dst                  |
| ds1-alarm               | exclusion               | ext-dn-dst <sup>1</sup> | flash                   |
| goto-cover              | grp-dn-dst <sup>1</sup> | hunt-ns                 | in-call-id              |
| inspect <sup>1</sup>    | int-aut-an              | last-numb               | link-alarm              |
| lsvn-halt               | lwc-cancel              | lwc-lock                | lwc-store               |
| major-alm               | man-msg-wt              | man-overid <sup>1</sup> | manual-in               |
| mct-act                 | mct-contr               | mf-da-intl              | mf-op-intl              |
| mj/mn alm               | msg-retr <sup>1</sup>   | mwn-act <sup>1</sup>    | mwn-deact <sup>1</sup>  |
| next <sup>1</sup>       | night-serv              | noans-alrt              | normal <sup>1</sup>     |
| per-COline              | pms-alarm               | pr-awu-alm              | pr-pms-alm              |
| pr-sys-alm              | print-msgs              | priority                | q-calls                 |
| q-time                  | release                 | ringer-off              | rs-alert                |
| rsvn-halt               | scroll                  | send-calls              | send-term               |
| serv-obsrv              | signal                  | ssvn-halt               | stored-num <sup>1</sup> |
| stroke-cnt              | term-x-gr               | timer <sup>1</sup>      | trk-ac-alm              |
| trk-id                  | trunk-name <sup>1</sup> | trunk-ns                | verify                  |
| voa-repeat              | vu-display              | work-code               |                         |

- 
1. Display-type button (not administrable on Coverage Module form).
  2. Not administrable on Feature Module form.

Page 4 of the form

Page 4 of X

| FEATURE BUTTON ASSIGNMENTS |  | STATION   |
|----------------------------|--|-----------|
| 1: _____                   |  | 13: _____ |
| 2: _____                   |  | 14: _____ |
| 3: _____                   |  | 15: _____ |
| 4: _____                   |  | 16: _____ |
| 5: _____                   |  | 17: _____ |
| 6: _____                   |  | 18: _____ |
| 7: _____                   |  | 19: _____ |
| 8: _____                   |  | 20: _____ |
| 9: _____                   |  | 21: _____ |
| 10: _____                  |  | 22: _____ |
| 11: _____                  |  | 23: _____ |
| 12: _____                  |  | 24: _____ |

Screen 6-50. 7405D Station form (Page 4 of X)

■ FEATURE BUTTON ASSIGNMENTS

The features buttons that you can assign to page 4 of the form are the same as those listed for BUTTON ASSIGNMENTS. Display-type feature buttons may only be assigned if Display is y.

Page X of the form (FEATURE MODULE  
BUTTON ASSIGNMENTS)

Page Y of X

| FEATURE MODULE BUTTON ASSIGNMENTS |  | STATION   |
|-----------------------------------|--|-----------|
| 1: _____                          |  | 13: _____ |
| 2: _____                          |  | 14: _____ |
| 3: _____                          |  | 15: _____ |
| 4: _____                          |  | 16: _____ |
| 5: _____                          |  | 17: _____ |
| 6: _____                          |  | 18: _____ |
| 7: _____                          |  | 19: _____ |
| 8: _____                          |  | 20: _____ |
| 9: _____                          |  | 21: _____ |
| 10: _____                         |  | 22: _____ |
| 11: _____                         |  | 23: _____ |
| 12: _____                         |  | 24: _____ |

Screen 6-51. 7405D Feature Module form (Page Y of X)

This page displays only if `Feature Module` is **y**. The feature buttons that you can assign are the same as those listed for `BUTTON ASSIGNMENTS` above. Call appearance and bridged call appearance buttons cannot be administered on this form.

If you want to assign feature buttons to the optional `Function Key Module` or `Coverage Module`, you must assign them on their respective forms.

### Page X of the form (COVERAGE MODULE BUTTON ASSIGNMENTS)

Page Y of X

| STATION         |                    |
|-----------------|--------------------|
| COVERAGE MODULE | BUTTON ASSIGNMENTS |
| 1: _____        | 11: _____          |
| 2: _____        | 12: _____          |
| 3: _____        | 13: _____          |
| 4: _____        | 14: _____          |
| 5: _____        | 15: _____          |
| 6: _____        | 16: _____          |
| 7: _____        | 17: _____          |
| 8: _____        | 18: _____          |
| 9: _____        | 19: _____          |
| 10: _____       | 20: _____          |

Screen 6-52. 7405D Coverage Module form (Page Y of X)

This page displays only if `Coverage Module` is **y**. The features buttons that you can assign are the same as those listed for the preceding `BUTTON ASSIGNMENTS`, except you cannot administer display-type buttons.

Up to 10 call appearance, 10 `abrdg-appr`, and 10 `brdg-appr` buttons can be distributed between a `Coverage Module` and the associated administrable buttons on the 7405D voice terminal.

### Page X of the form (DISPLAY BUTTON ASSIGNMENTS)

Page Y of X

STATION  
DISPLAY BUTTON ASSIGNMENTS

1: \_\_\_\_\_  
2: \_\_\_\_\_  
3: \_\_\_\_\_  
4: \_\_\_\_\_  
5: \_\_\_\_\_  
6: \_\_\_\_\_  
7: \_\_\_\_\_

Screen 6-53. 7405D Display form (Page Y of X)

This page displays only if `Display` is **y**. The display-type buttons that you can assign are noted on the above list.

### Page X of the form (DATA MODULE)

Page Y of X

STATION

DATA MODULE

Data Extension: \_\_\_\_\_ Name: \_\_\_\_\_ BCC: 2  
COS: 1\_  
COR: 1\_  
ITC: restricted TN: 1\_

ABBREVIATED DIALING  
List1: \_\_\_\_\_

SPECIAL DIALING OPTION: hot-line  
HOT LINE DESTINATION  
DEFAULT DIALING  
Abbreviated Dialing Dial Code (From above list): \_\_\_\_

ASSIGNED MEMBER (Station with a data extension button for this data module)

| Ext      | Name  |
|----------|-------|
| 1. _____ | _____ |

Screen 6-54. 7405D Data Module form (Page Y of X)

This page displays only if `Data Module` is **y**. Button locations (1 through 7) are associated with buttons 1 through 7 on the optional Digital Display Module.

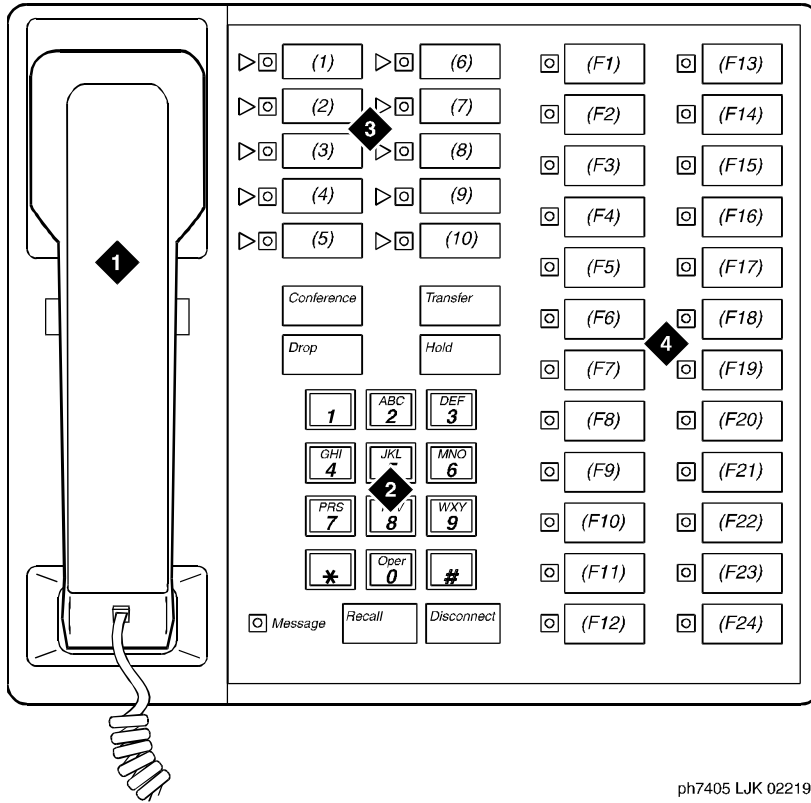

ph7405 LJK 022197

Figure Notes

- 1. Handset
- 2. Dial pad

- 3. 10 programmable buttons
- 4. 24 feature buttons

Figure 6-27. 7405D voice terminal

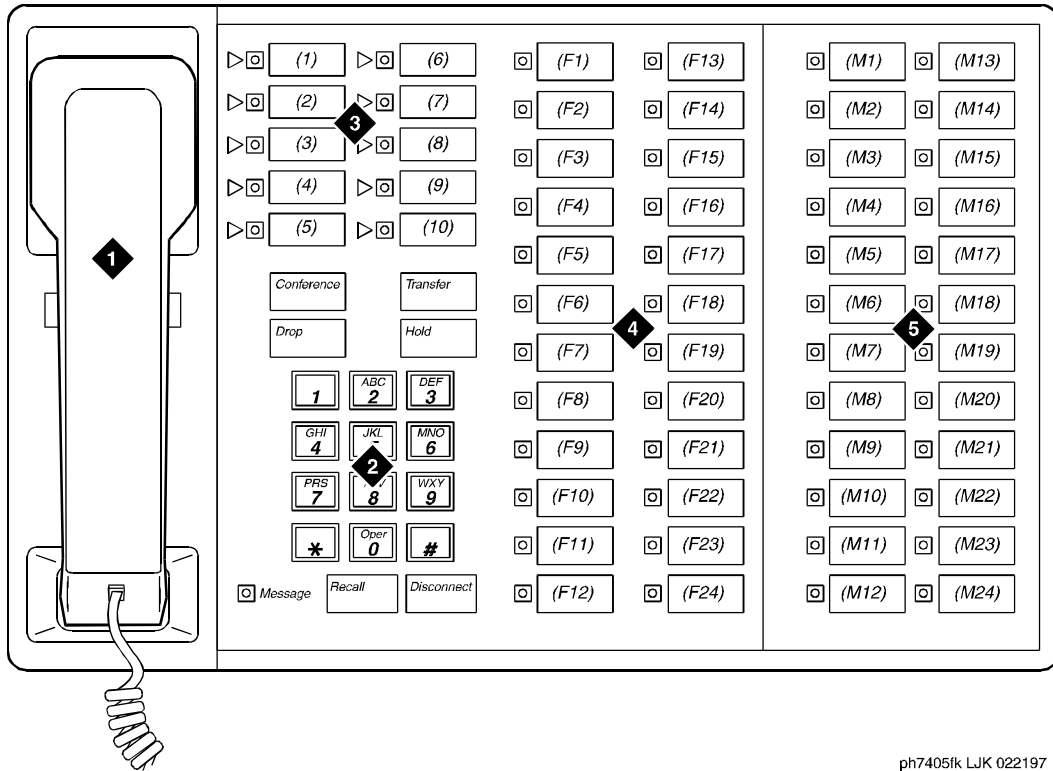

ph7405fk LJK 022197

### Figure Notes

- |             |   |
|-------------|---|
| 1. Handset  | 3. 10 programmable buttons                            |
| 2. Dial pad | 4. 24 feature buttons                                 |
|             | 5. Function key module with 24 feature module buttons |

Figure 6-28. 7405D voice terminal with optional function key module

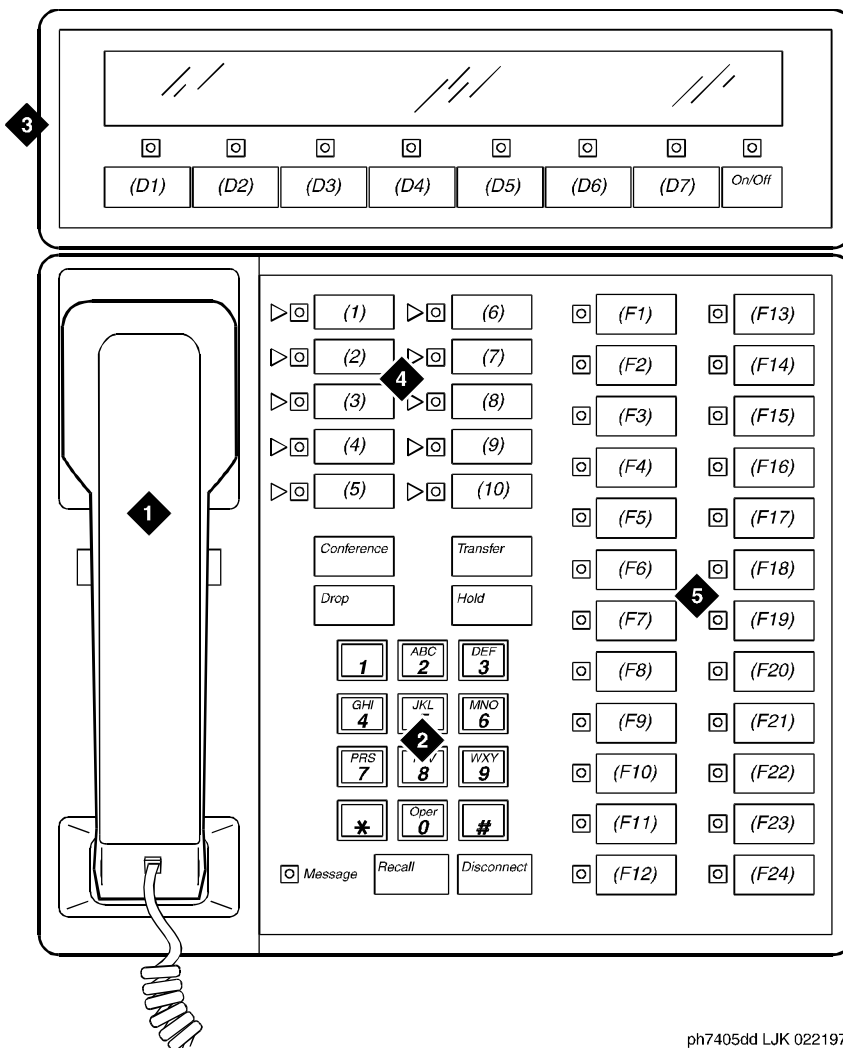

ph7405dd LJK 022197

Figure Notes

- |   |   |
|---|---|
| <ul style="list-style-type: none"> <li>1. Handset</li> <li>2. Dial pad</li> </ul> | <ul style="list-style-type: none"> <li>3. Digital display module with 7 display buttons</li> <li>4. 10 programmable buttons</li> <li>5. 24 feature buttons</li> </ul> |
|---|---|

Figure 6-29. 7405D voice terminal with optional digital display module



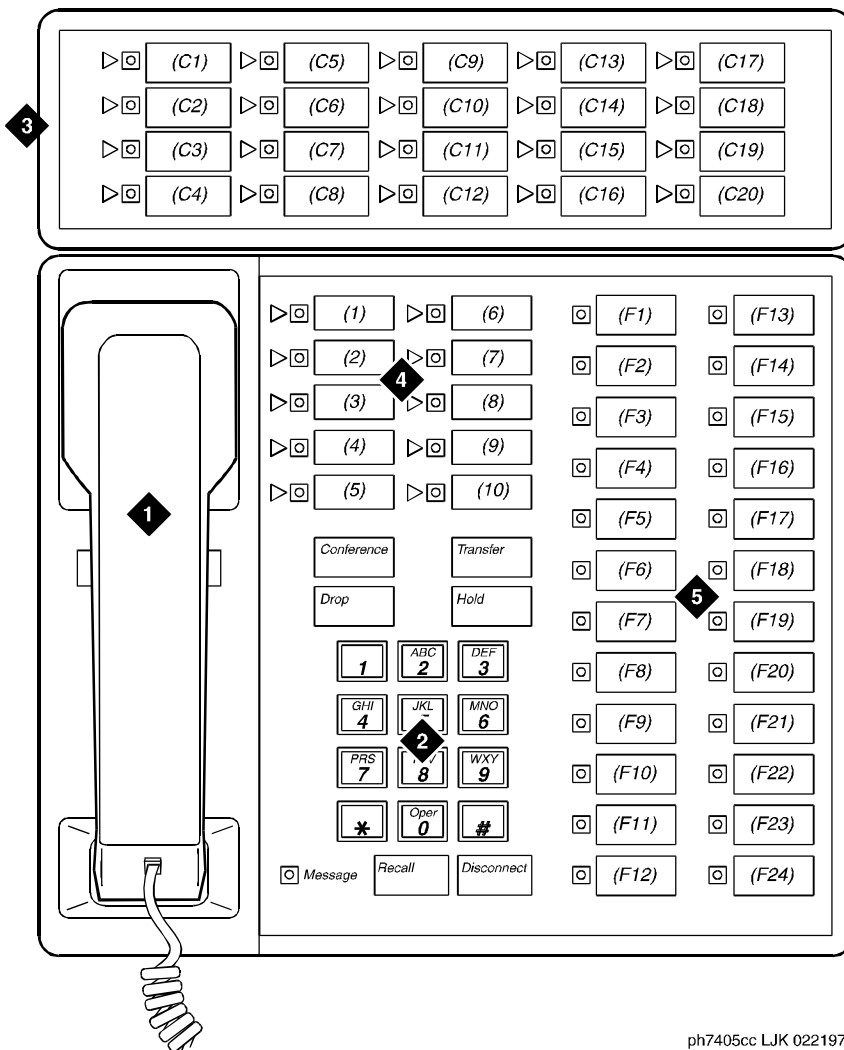

ph7405cc LJK 022197

Figure Notes

- |   |   |
|---|---|
| <ul style="list-style-type: none"> <li>1. Handset</li> <li>2. Dial pad</li> </ul> | <ul style="list-style-type: none"> <li>3. Call coverage module with 20 coverage module buttons and status lamps</li> <li>4. 10 programmable buttons</li> <li>5. 24 feature buttons</li> </ul> |
|---|---|

Figure 6-30. 7405D voice terminal with optional call coverage module

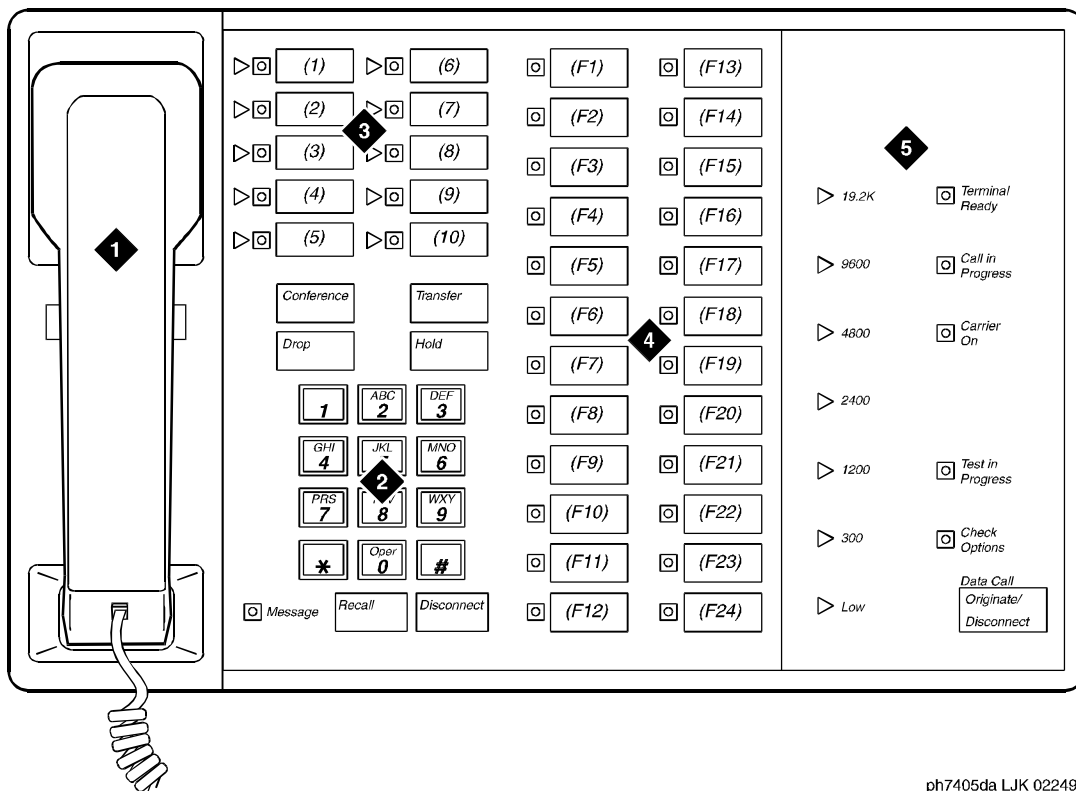

ph7405da LJK 022497

### Figure Notes

- |             |                                 |
|-------------|---------------------------------|
| 1. Handset  | 3. 10 programmable buttons      |
| 2. Dial pad | 4. 24 feature buttons           |
|             | 5. Digital terminal data module |

Figure 6-31. 7405D voice terminal with optional digital terminal data module

## 7406D, 7406+, 7407D, and 7407+ voice terminals

### Form instructions

To administer a 7406D, 7406+, 7407D, or 7407+ voice terminal, complete the standard as well as the following unique Station form fields.

### Page 1 of the form

Page 1 of X

STATION

|                 |                        |         |
|-----------------|------------------------|---------|
| Extension: 1003 | Lock Messages? n       | BCC: 0  |
| Type: 7406D__   | Security Code: _____   | TN: 1_  |
| Port: _____     | Coverage Path 1: _____ | COR: 1_ |
| Name: _____     | Coverage Path 2: _____ | COS: 1_ |
|                 | Hunt-to Station: _____ |         |

STATION OPTIONS

|                           |                                 |
|---------------------------|---------------------------------|
| Data Module? y            | Personalized Ringing Pattern: 1 |
| Display Module? n         | Message Lamp Ext: 1000          |
| Display Language: english |                                 |
|                           | MM Complex Data Ext: _____      |

### Screen 6-55. 7406D, 7406+, 7407D, 7407+ Station form (Page 1 of X)

- **Type** — Enter **7406D**, **7406+**, **7407D**, or **7407+** as appropriate.
- **Data Module** — Enter **y** (default) if this voice terminal is equipped with an optional 703A Data Stand (7406D or 7406+), a 702AL1-DSU (7407D or 7407+), 7400B, or 8400B Data Module (7406D, 7406+, 7407D, or 7407+) and connected to an associated data terminal. If you enter **y**, you must complete the Data Module form.
- **Display Module** — For the 7406D and 7406+, enter **y** if the voice terminal is equipped with an optional digital display. Display-only field (set to **y**) for the 7407D and 7407+ terminals. If this field is set to **y**, you must complete the Display Button Assignments form. Default is **n**.

### Page 2 of the form

|                                |  |                                    |
|--------------------------------|--|------------------------------------|
|                                |  | Page 2 of X                        |
|                                |  | STATION                            |
| FEATURE OPTIONS                |  |                                    |
| LWC Reception? msa-spe         |  | Auto Select Any Idle Appearance? n |
| LWC Activation? y              |  | Coverage Msg Retrieval? y          |
| CDR Privacy? n                 |  | Auto Answer: none                  |
| Redirect Notification? y       |  | Data Restriction? n                |
| Per Button Ring Control? n     |  | Idle Appearance Preference? n      |
| Bridged Call Alerting? n       |  |                                    |
| Active Station Ringing: single |  | Restrict Last Appearance? y        |
|                                |  |                                    |
| H.320 Conversion? n            |  | Multimedia Early Answer? n         |
| AUDIX Name: _____              |  | Audible Message Waiting? y         |
| Messaging Server Name: _____   |  | Display Client Redirection? n      |
|                                |  | Select Last Used Appearance? n     |

Screen 6-56. 7406D, 7406+, 7407D, 7407+ Station form (Page 2 of X)

### Page 3 of the form

|                     |              |                  |
|---------------------|--------------|------------------|
|                     |              | Page 3 of X      |
|                     |              | STATION          |
| SITE DATA           |              |                  |
| Room: _____         |              | Headset? n       |
| Jack: _____         |              | Speaker? n       |
| Cable: _____        |              | Mounting: d      |
| Floor: _____        |              | Cord Length: 0_  |
| Building: _____     |              | Set Color: _____ |
|                     |              |                  |
| ABBREVIATED DIALING |              |                  |
| List1: _____        | List2: _____ | List3: _____     |
|                     |              |                  |
| BUTTON ASSIGNMENTS  |              |                  |
| 1: call-appr_       | 4: _____     |                  |
| 2: call-appr_       | 5: _____     |                  |
| 3: call-appr_       |              |                  |

Screen 6-57. 7406D and 7406+ Station form (Page 3 of X)

Page 3 of X

STATION

SITE DATA

|                 |                  |
|-----------------|------------------|
| Room: _____     | Headset? n       |
| Jack: _____     | Speaker? n       |
| Cable: _____    | Mounting: d      |
| Floor: _____    | Cord Length: 0_  |
| Building: _____ | Set Color: _____ |

ABBREVIATED DIALING

|              |              |              |
|--------------|--------------|--------------|
| List1: _____ | List2: _____ | List3: _____ |
|--------------|--------------|--------------|

BUTTON ASSIGNMENTS

|               |           |
|---------------|-----------|
| 1: call-appr_ | 6: _____  |
| 2: call-appr_ | 7: _____  |
| 3: call-appr_ | 8: _____  |
| 4: _____      | 9: _____  |
| 5: _____      | 10: _____ |

Screen 6-58. 7407D and 7407+ Station form (Page 3 of X)

- **Headset** — For the 7406D and 7406+, enter **y** if a headset is to be used. (7407D and 7407+ terminals cannot have headsets.) Default is **n**.

- **BUTTON ASSIGNMENTS**

The feature buttons that you can assign to the 7406D, 7406+, 7407D, or 7407+ voice terminals are listed below. The first 3 buttons default as call appearance.

|                         |                         |                         |                         |
|-------------------------|-------------------------|-------------------------|-------------------------|
| abr-prog                | abr-spchar              | abrdg-appr              | abrv-dial               |
| abrv-ring               | ac-alarm                | aca-halt                | after-call              |
| alrt-agchg              | alt-fri                 | assist                  | asvn-halt               |
| atd-qcalls <sup>1</sup> | atd-qtime               | aut-msg-wt              | auto-cback              |
| auto-icom               | auto-in                 | auto-wkup <sup>1</sup>  | autodial                |
| aux-work                | brdg-appr               | busy-ind                | call-appr               |
| call-disp <sup>1</sup>  | call-fwd                | call-park               | call-pkup               |
| callr-info <sup>1</sup> | cas-backup              | cdr1-alm                | cdr2-alm                |
| cfwd-bsyda              | check-in <sup>1</sup>   | check-out <sup>1</sup>  | clk-overid <sup>1</sup> |
| consult                 | cov-cback               | cov-msg-rt <sup>1</sup> | data-ext                |
| date-time <sup>1</sup>  | delete-msg <sup>1</sup> | dial-icom               | directory <sup>1</sup>  |
| dir-pkup                | disp-chrg               | disp-norm               | dn-dst                  |
| ds1-alarm               | exclusion               | ext-dn-dst <sup>1</sup> | flash                   |
| goto-cover              | grp-dn-dst <sup>1</sup> | hunt-ns                 | in-call-id              |
| inspect <sup>1</sup>    | int-aut-an              | last-numb               | link-alarm              |
| lsvn-halt               | lwc-cancel              | lwc-lock                | lwc-store               |
| major-alm               | man-msg-wt              | man-overid <sup>1</sup> | manual-in               |
| mct-act                 | mct-contr               | mf-da-intl              | mf-op-intl              |
| mj/mn alm               | msg-retr <sup>1</sup>   | mwn-act <sup>1</sup>    | mwn-deact <sup>1</sup>  |
| next <sup>1</sup>       | night-serv              | noans-alrt              | normal <sup>1</sup>     |
| per-COline              | pms-alarm               | pr-awu-alm              | pr-pms-alm              |
| pr-sys-alm              | print-msgs              | priority                | q-calls                 |
| q-time                  | release                 | ringer-off              | rs-alert                |
| rsvn-halt               | scroll                  | send-calls              | send-term               |
| serv-obsrv              | signal                  | ssvn-halt               | stored-num <sup>1</sup> |
| stroke-cnt              | term-x-gr               | timer <sup>1</sup>      | trk-ac-alm              |
| trk-id                  | trunk-name <sup>1</sup> | trunk-ns                | verify                  |
| voa-repeat              | vu-display              | work-code               |                         |

---

1. Display-type button

Page 4 of the form

Page 4 of X

| FEATURE BUTTON ASSIGNMENTS | STATION   |
|----------------------------|-----------|
| 1: _____                   | 2: _____  |
|                            | 3: _____  |
|                            | 4: _____  |
| 5: _____                   | 12: _____ |
| 6: _____                   | 13: _____ |
| 7: _____                   | 14: _____ |
| 8: _____                   | 15: _____ |
| 9: _____                   | 16: _____ |
| 10: _____                  | 17: _____ |
| 11: _____                  | 18: _____ |

Screen 6-59. 7406D Station form (Page 4 of X)

Page 4 of X

| FEATURE BUTTON ASSIGNMENTS | STATION   |
|----------------------------|-----------|
| 1: _____                   | 2: _____  |
|                            | 4: _____  |
| 3: _____                   | 12: _____ |
| 5: _____                   | 13: _____ |
| 6: _____                   | 14: _____ |
| 7: _____                   | 15: _____ |
| 8: _____                   | 16: _____ |
| 9: _____                   | 17: _____ |
| 10: _____                  | 18: _____ |
| 11: _____                  |           |

Screen 6-60. 7406+ Station form (Page 4 of X)

| FEATURE BUTTON ASSIGNMENTS | STATION   |
|----------------------------|-----------|
| 1: _____                   | 2: _____  |
| 3: _____                   | 14: _____ |
| 4: _____                   | 15: _____ |
| 5: _____                   | 16: _____ |
| 6: _____                   | 17: _____ |
| 7: _____                   | 18: _____ |
| 8: _____                   | 19: _____ |
| 9: _____                   | 20: _____ |
| 10: _____                  | 21: _____ |
| 11: _____                  | 22: _____ |
| 12: _____                  | 23: _____ |
| 13: _____                  | 24: _____ |

Screen 6-61. 7407D and 7407+ Voice-terminal form (Page 4 of X)

■ **FEATURE BUTTON ASSIGNMENTS**

The features and functions that you can assign to the 7406D, 7406+, 7407D, or 7407+ voice terminal administrable buttons are the same as those listed for BUTTON ASSIGNMENTS above.

For 7406D and 7406+ voice terminals, only buttons 1 through 4 have status lamps. It is recommended that feature button assignments requiring status lamp indications not be administered to buttons 5 through 18. Feature buttons 2 and 3 do not work, even if administered, for set versions. Buttons 5 through 11 are dual function buttons. An associated Shift button on the voice terminal is used to enable either buttons 5 through 11 or enable associated buttons 12 through 18.

For 7407D and 7407+ voice terminals, only buttons 1 and 2 have status lamps. It is recommended that feature button assignments requiring status lamp indications not be administered to buttons 3 through 24.



## Page X of the form (DISPLAY BUTTON ASSIGNMENTS)

Page Y of X

STATION  
DISPLAY BUTTON ASSIGNMENTS

1: \_\_\_\_\_  
2: \_\_\_\_\_  
3: \_\_\_\_\_  
4: \_\_\_\_\_  
5: \_\_\_\_\_  
6: \_\_\_\_\_  
7: \_\_\_\_\_

### Screen 6-62. 7407D, and 7407+ Station form (Page Y of X)

This page displays only if `TYPE` is **7407D** or **7407+**. The display buttons that can be administered are noted on the above `BUTTON ASSIGNMENTS` list. The abbreviated names as shown on the list must be entered on the form.

## Page X of the form (DATA MODULE)

Page Y of X

STATION  
DATA MODULE

Data Extension: \_\_\_\_\_ Name: \_\_\_\_\_ BCC: 2  
COS: 1\_  
COR: 1\_  
ITC: restricted TN: 1\_

ABBREVIATED DIALING

List1: \_\_\_\_\_

SPECIAL DIALING OPTION: hot-line

HOT LINE DESTINATION

DEFAULT DIALING

Abbreviated Dialing Dial Code (From above list): \_\_\_\_

ASSIGNED MEMBER (Station with a data extension button for this data module)

| Ext      | Name  |
|----------|-------|
| 1. _____ | _____ |

### Screen 6-63. 7406D, 7406+, 7407D, and 7407+ Data Module form (Page Y of X)

This page displays only if `Data Module` is **y**.

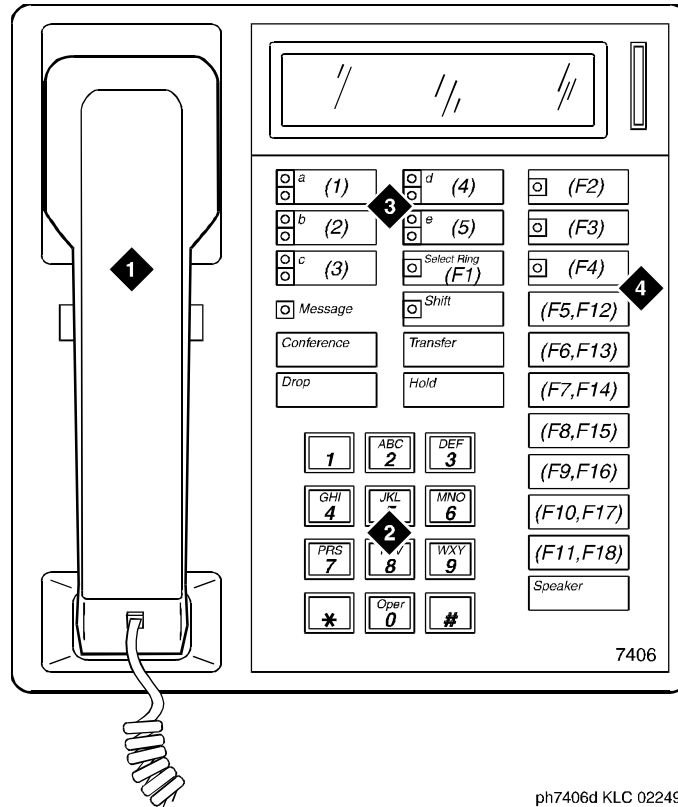

ph7406d KLC 022497

Figure Notes

- |             |   |
|-------------|---|
| 1. Handset  | 3. 5 programmable buttons   |
| 2. Dial pad | 4. 18 feature buttons (feature buttons F12 to F18 are enabled with the Shift key) |

Figure 6-32. 7406D voice terminal

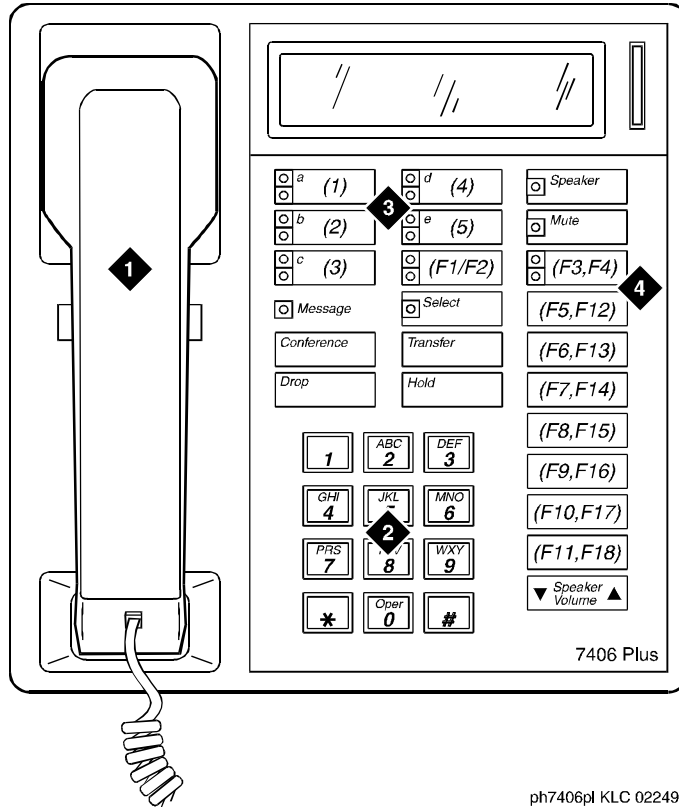

ph7406pt KLC 022497

Figure Notes

- |             |   |
|-------------|---|
| 1. Handset  | 3. 5 programmable buttons   |
| 2. Dial pad | 4. 18 feature buttons (feature buttons F2, F4, and F12 to F18 are enabled with the Shift key) |

Figure 6-33. 7406D+ voice terminal

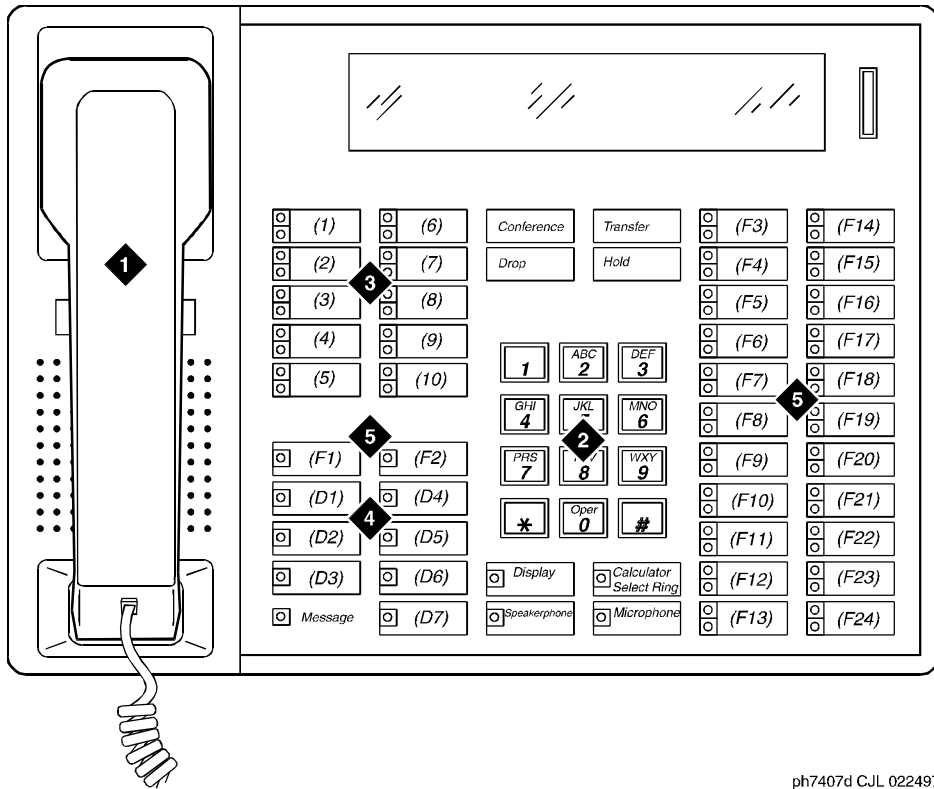

ph7407d CJL 022497

Figure Notes

- |             |                            |
|-------------|----------------------------|
| 1. Handset  | 3. 10 programmable buttons |
| 2. Dial pad | 4. 7 display buttons       |
|             | 5. 24 feature buttons      |

Figure 6-34. 7407D voice terminal

## 7434D and 7444D voice terminal

### Form instructions

To administer a 7434D or 7444D voice terminal, complete the standard as well as the following unique Station form fields.

### Page 1 of the form

Page 1 of X

STATION

|                 |                        |          |
|-----------------|------------------------|----------|
| Extension: 1003 | Lock Messages? n       | BCC: 2   |
| Type: 7434D__   | Security Code: _____   | TN: 1__  |
| Port: _____     | Coverage Path 1: _____ | COR: 1__ |
| Name: _____     | Coverage Path 2: _____ | COS: 1__ |
|                 | Hunt-to Station: _____ |          |

STATION OPTIONS

|                           |                                 |
|---------------------------|---------------------------------|
| Data Module? y            | Personalized Ringing Pattern: 1 |
| Display Module? y         | Message Lamp Ext: 1000          |
| Display Language: english |                                 |
|                           | Coverage Module? n              |
|                           | MM Complex Data Ext: _____      |

### Screen 6-64. 7434D and 7444D Station form (Page 1 of X)

- **Type** — Enter **7434D**, or **7444D**.
- **Data Module** — Enter **y** if this terminal is connected to an optional 7400B or 8400B Data Module. If you enter **y**, you must complete the Data Module form. Default is **n**.
- **Display Module** — Enter **y** if the voice terminal is to have a display by an optional Digital Display Module. Display only field (set to **y**) for 7444D terminals. If this field is set to **y**, you must complete the Display Button assignments form. Default is **n**.
- **Coverage Module** — This field displays only for 7434D terminals. Enter **y** if the voice terminal is to be connected to an optional Call Coverage Module. If you enter **y**, you must complete the Coverage Module form. The voice terminal cannot have an optional Coverage Module and optional Digital Display Module at the same time. Default is **n**.

## Page 2 of the form

```

                                                                 Page 2 of X
                                STATION
FEATURE OPTIONS
  LWC Reception? msa-spe          Auto Select Any Idle Appearance? n
  LWC Activation? y              Coverage Msg Retrieval? y
  CDR Privacy? n                 Auto Answer: none
  Redirect Notification? y       Data Restriction? n
  Per Button Ring Control? n    Idle Appearance Preference? n
  Bridged Call Alerting? n      Restrict Last Appearance? y
  Active Station Ringing: single
                                   Multimedia Early Answer? n
                                   Audible Message Waiting? y
                                   Display Client Redirection? n
                                   Select Last Used Appearance? n
  H.320 Conversion? n
  AUDIX Name: _____
  Messaging Server Name: _____
```

### Screen 6-65. 7434D and 7444D Station form (Page 2 of X)

## Page 3 of the form

```

                                                                 Page 3 of X
                                STATION
SITE DATA
  Room: _____              Headset? n
  Jack: _____              Speaker? n
  Cable: _____             Mounting: d
  Floor: _____             Cord Length: 0_
  Building: _____          Set Color: _____
ABBREVIATED DIALING
  List1: _____            List2: _____            List3: _____
BUTTON ASSIGNMENTS
  1: call-appr_              6: _____
  2: call-appr_              7: _____
  3: call-appr_              8: _____
  4: _____                9: _____
  5: _____                10: _____
```

### Screen 6-66. 7434D and 7444D Station form (Page 3 of X)

#### ■ BUTTON ASSIGNMENTS

The feature buttons that you can assign to the 7434D voice terminal are listed below. The first three buttons are defaulted as call appearance.

|                         |                         |                         |                         |
|-------------------------|-------------------------|-------------------------|-------------------------|
| abr-prog                | abr-spchar              | abrdg-appr              | abrv-dial               |
| abrv-ring               | ac-alarm                | aca-halt                | after-call              |
| alrt-agchg              | alt-frl                 | assist                  | asvn-halt               |
| atd-qcalls <sup>1</sup> | atd-qtime <sup>1</sup>  | aut-msg-wt              | auto-cback              |
| auto-icom               | auto-in                 | auto-wkup <sup>1</sup>  | autodial                |
| aux-work                | brdg-appr               | busy-ind                | call-appr               |
| call-disp <sup>1</sup>  | call-fwd                | call-park               | call-pkup               |
| callr-info <sup>1</sup> | cas-backup              | cdr1-alm                | cdr2-alm                |
| cfwd-bsyda              | check-in <sup>1</sup>   | check-out <sup>1</sup>  | clk-overid <sup>1</sup> |
| consult                 | cov-cback               | cov-msg-rt <sup>1</sup> | data-ext                |
| date-time <sup>1</sup>  | delete-msg <sup>1</sup> | dial-icom               | directory <sup>1</sup>  |
| dir-pkup                | disp-chrg               | disp-norm               | dn-dst                  |
| ds1-alarm               | exclusion               | ext-dn-dst <sup>1</sup> | flash                   |
| goto-cover              | grp-dn-dst <sup>1</sup> | hunt-ns                 | in-call-id              |
| inspect <sup>1</sup>    | int-aut-an              | last-numb               | link-alarm              |
| lsvn-halt               | lwc-cancel              | lwc-lock                | lwc-store               |
| major-alm               | man-msg-wt              | man-overid <sup>1</sup> | manual-in               |
| mct-act                 | mct-contr               | mj/mn alm               | msg-retr <sup>1</sup>   |
| mwn-act <sup>1</sup>    | mwn-deact <sup>1</sup>  | next <sup>1</sup>       | night-serv              |
| noans-alrt              | normal <sup>1</sup>     | per-COline              | pms-alarm               |
| pr-awu-alm              | pr-pms-alm              | pr-sys-alm              | print-msgs              |
| priority                | q-calls                 | q-time                  | release                 |
| ringer-off              | rs-alert                | rsvn-halt               | scroll                  |
| send-calls              | send-term               | serv-obsrv              | signal                  |
| ssvn-halt               | stored-num <sup>1</sup> | stroke-cnt              | term-x-gr               |
| timer <sup>1</sup>      | trk-ac-alm              | trk-id                  | trunk-name <sup>1</sup> |
| trunk-ns                | verify                  | voa-repeat              | vu-display              |
| work-code               |                         |                         |                         |

---

1. Display-type button

Page 4 of the form

Page 4 of X

STATION

BUTTON ASSIGNMENTS

|           |           |
|-----------|-----------|
| 11: _____ | 23: _____ |
| 12: _____ | 24: _____ |
| 13: _____ | 25: _____ |
| 14: _____ | 26: _____ |
| 15: _____ | 27: _____ |
| 16: _____ | 28: _____ |
| 17: _____ | 29: _____ |
| 18: _____ | 30: _____ |
| 19: _____ | 31: _____ |
| 20: _____ | 32: _____ |
| 21: _____ | 33: _____ |
| 22: _____ | 34: _____ |

Screen 6-67. 7434D and 7444D Station form (Page 4 of X)

■ **BUTTON ASSIGNMENTS**

The feature buttons that you can assign are the same as those listed for BUTTON ASSIGNMENTS above. This form is used to assign features to the 24 administrable buttons on the 7434D or 7444D voice terminal (may include call appearance and bridged call appearance buttons). If you want to assign feature buttons to the optional Coverage Module, assign them on the Coverage Module page of the form.

Page X of the form (COVERAGE MODULE  
BUTTON ASSIGNMENTS)

Page Y of X

STATION

COVERAGE MODULE BUTTON ASSIGNMENTS

|           |           |
|-----------|-----------|
| 1: _____  | 11: _____ |
| 2: _____  | 12: _____ |
| 3: _____  | 13: _____ |
| 4: _____  | 14: _____ |
| 5: _____  | 15: _____ |
| 6: _____  | 16: _____ |
| 7: _____  | 17: _____ |
| 8: _____  | 18: _____ |
| 9: _____  | 19: _____ |
| 10: _____ | 20: _____ |

Screen 6-68. 7434D Coverage Module form (Page Y of X)



This page displays only if Coverage Module is **y**. The features buttons that you can assign are the same as those listed for BUTTON ASSIGNMENTS above except that you cannot assign display-type buttons. A minimum of 2 or a maximum of 10 call appearance buttons can be administered. When 2 call appearance buttons are administered, the maximum number of Bridged Appearance buttons that can be administered is 52 with a Coverage Module or 32 without a Coverage Module.

### Page X of the form (DISPLAY BUTTON ASSIGNMENTS)

|    |                            |
|----|----------------------------|
|    | Page Y of X                |
|    | STATION                    |
|    | DISPLAY BUTTON ASSIGNMENTS |
| 1: | _____                      |
| 2: | _____                      |
| 3: | _____                      |
| 4: | _____                      |
| 5: | _____                      |
| 6: | _____                      |
| 7: | _____                      |

Screen 6-69. 7434D and 7444D Display form (Page Y of X)

This page displays only if Display is **y**. The display-type buttons that you can assign are shown on the BUTTON ASSIGNMENTS list. Button locations (1 through 7) are associated with buttons 1 through 7 on the optional Digital Display Module.

Page X of the form (DATA MODULE)

Page Y of X

STATION

DATA MODULE

Data Extension: \_\_\_\_\_ Name: \_\_\_\_\_ BCC: 2  
COS: 1\_  
COR: 1\_  
ITC: restricted TN: 1\_

ABBREVIATED DIALING  
List1: \_\_\_\_\_

SPECIAL DIALING OPTION: hot-line  
HOT LINE DESTINATION  
DEFAULT DIALING  
Abbreviated Dialing Dial Code (From above list): \_\_\_\_

ASSIGNED MEMBER (Station with a data extension button for this data module)

| Ext      | Name  |
|----------|-------|
| 1. _____ | _____ |

Screen 6-70. 7434D and 7444D Data Module form (Page Y of X)

This page displays only if Data Module is y.

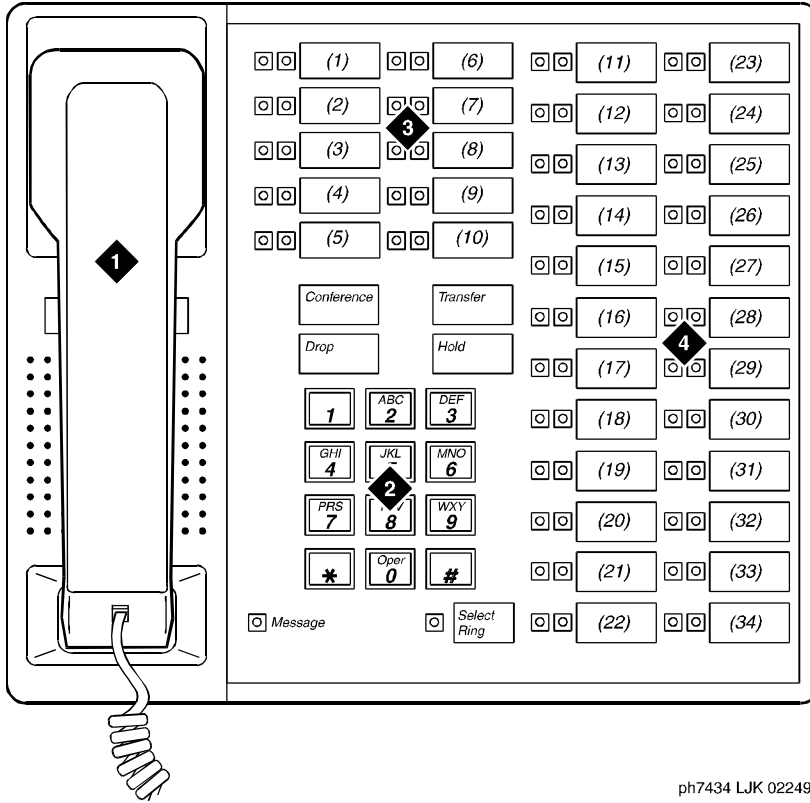

ph7434 LJK 022497

Figure Notes

- |             |                                  |
|-------------|----------------------------------|
| 1. Handset  | 3. 10 programmable buttons       |
| 2. Dial pad | 4. 24 feature buttons (11 to 34) |

Figure 6-35. 7434D voice terminal

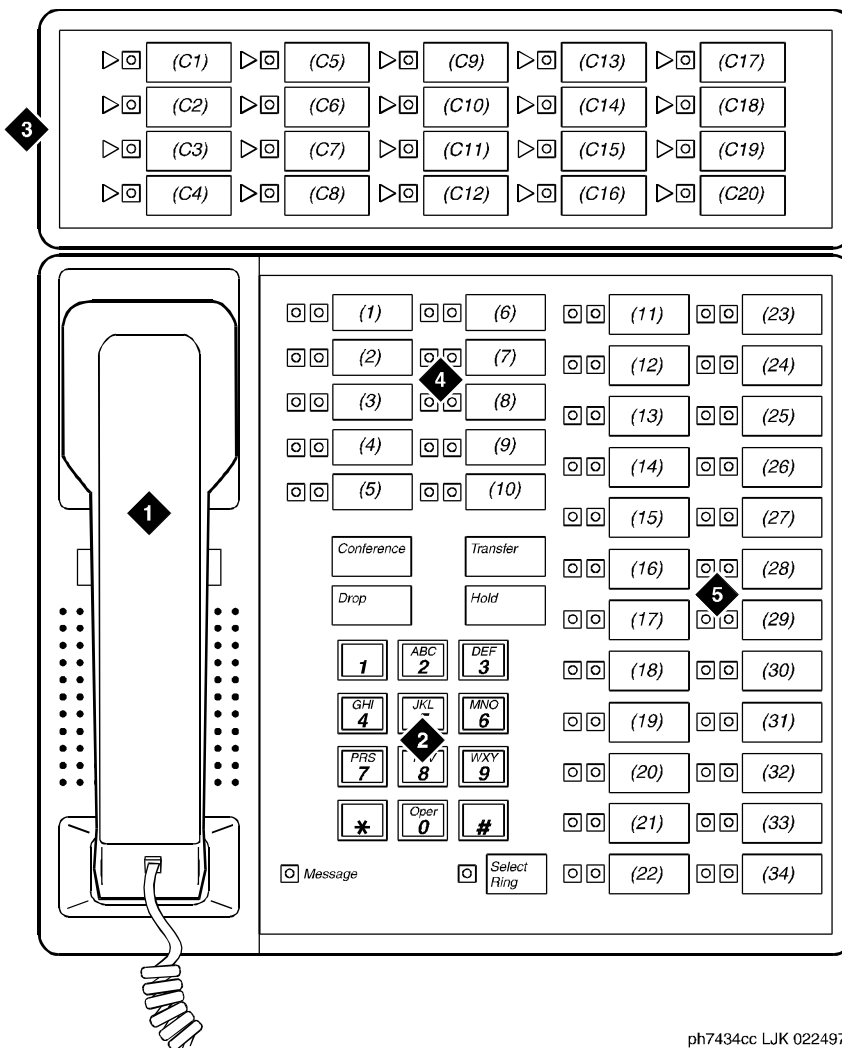

ph7434cc LJK 022497

Figure Notes

- |   |  |
|---|--|
| <ul style="list-style-type: none"> <li>1. Handset</li> <li>2. Dial pad</li> </ul> | <ul style="list-style-type: none"> <li>3. Call coverage module with 20 coverage module buttons and status lamps</li> <li>4. 10 programmable buttons</li> <li>5. 24 feature buttons (11 to 34)</li> </ul> |
|---|--|

Figure 6-36. 7434D voice terminal with optional call coverage module

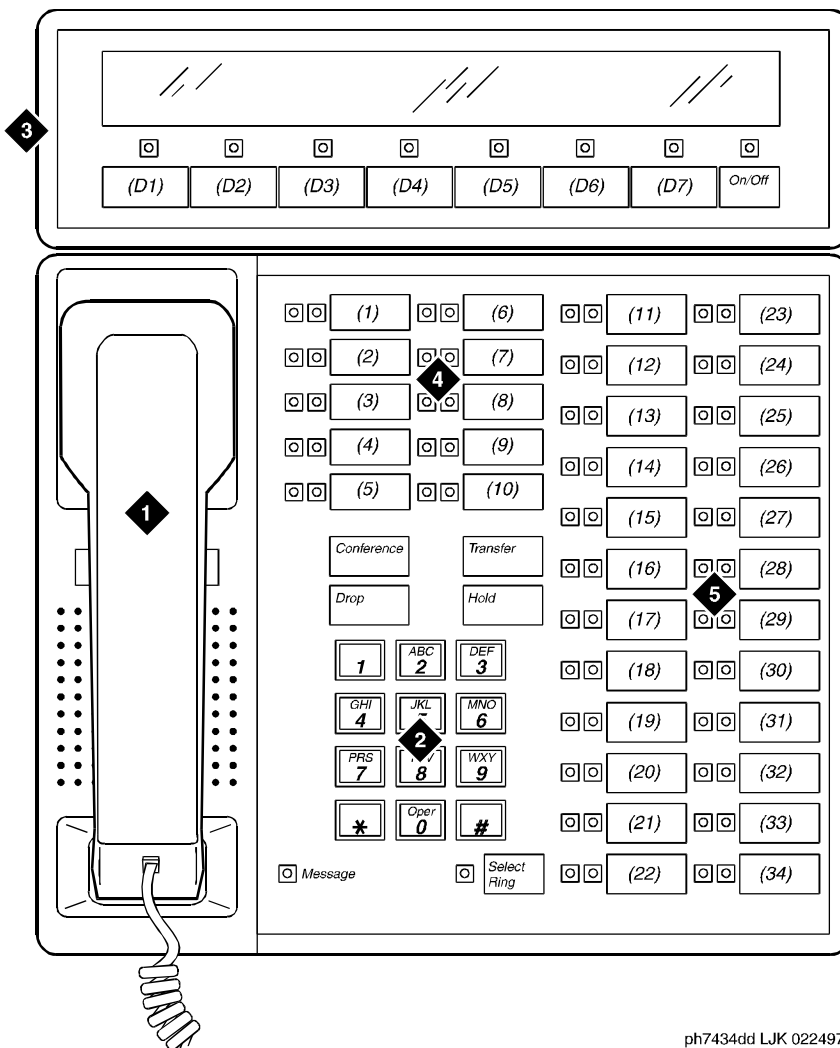

ph7434dd LJK 022497

Figure Notes

- |   |  |
|---|--|
| <ul style="list-style-type: none"> <li>1. Handset</li> <li>2. Dial pad</li> </ul> | <ul style="list-style-type: none"> <li>3. Digital display module with 7 display buttons</li> <li>4. 10 programmable buttons</li> <li>5. 24 feature buttons (11 to 34)</li> </ul> |
|---|--|

Figure 6-37. 7434D voice terminal with optional digital display module

## 7505D, 7506D, 7507D, 8503D, 8510T, and 8520T ISDN-BRI voice terminals

### Form instructions

To administer a 7505D, 7506D, 7507D, 8503D, 8510T, or 8520T ISDN-BRI voice terminal, complete the standard as well as the following unique Station form fields.

### Page 1 of the form

Page 1 of X

STATION

|                 |                        |         |
|-----------------|------------------------|---------|
| Extension: 1003 | Lock Messages? n       | BCC: 0  |
| Type: 7505D__   | Security Code: _____   | TN: 1_  |
| Port: _____     | Coverage Path 1: _____ | COR: 1_ |
| Name: _____     | Coverage Path 2: _____ | COS: 1_ |
|                 | Hunt-to Station: _____ |         |

STATION OPTIONS

|                             |                        |
|-----------------------------|------------------------|
| Data Module? y              | Message Lamp Ext: 1000 |
| Display Language: english__ |                        |

|                |               |                 |                 |
|----------------|---------------|-----------------|-----------------|
| XID? n         | Fixed TEI? y  | TEI: __         |                 |
| MIM Support? n | Endpt Init? y | SPID: 1000_____ | MIM Mtce/Mgt? n |

### Screen 6-71. 7505D, 7506D, 7507D, 8503D, 8510T, and 8520T Station form (Page 1 of X)

- **Type** — Enter **7505D**, **7506D**, **7507D**, **8503D**, **8510T**, or **8520T** as appropriate.
- **Data Module** displays only for the 7505D, 7506D, 7507D, 8510T, and 8520T ISDN-BRI voice terminals.
- **Fixed TEI** and **TEI** do not display for the 8510T and 8520T voice terminals. When adding an unsupported station using Enhanced Terminal Administration, if this field is **y**, TEI displays.
- **Display Language** displays only for 7506D, 7507D, 8510T, and 8520T terminals.

### Page 2 of the form

Page 2 of X

| FEATURE OPTIONS              | STATION                            |
|------------------------------|------------------------------------|
| LWC Reception? msa-spe       | Auto Select Any Idle Appearance? n |
| LWC Activation? y            | Coverage Msg Retrieval? y          |
| CDR Privacy? n               | Auto Answer: none                  |
| Redirect Notification? y     | Data Restriction? n                |
| Per Button Ring Control? n   | Idle Appearance Preference? n      |
| Bridged Call Alerting? n     | Restrict Last Appearance? y        |
| H.320 Conversion? n          | Multimedia Early Answer? n         |
| AUDIX Name: _____            | Audible Message Waiting? y         |
| Messaging Server Name: _____ | Display Client Redirection? n      |
|                              | Select Last Used Appearance? n     |

Screen 6-72. 7505D, 7506D, 7507D, 8503D, 8510T, and 8520T Station form (Page 2 of X)

- **Display Client Redirection** displays only for 7506D, 7507D, 8510T, and 8520T terminals.

### Page 3 of the form

Page 3 of X

| SITE DATA           | STATION          |
|---------------------|------------------|
| Room: _____         | Headset? n       |
| Jack: _____         | Speaker? n       |
| Cable: _____        | Mounting: d      |
| Floor: _____        | Cord Length: 0_  |
| Building: _____     | Set Color: _____ |
| ABBREVIATED DIALING | List2: _____     |
| List1: _____        | List3: _____     |
| BUTTON ASSIGNMENTS  |                  |
| 1: call-appr_       | 6: _____         |
| 2: call-appr_       | 7: _____         |
| 3: call-appr_       | 8: _____         |
| 4: _____            | 9: _____         |
| 5: _____            | 10: _____        |

Screen 6-73. 7505D, 7506D, 7507D, 8510T, and 8520T Station form (Page 3 of X)

## Implementation note

For a 7505D or 7506D voice terminal, button 7 can be administered as a call appearance button if an Asynchronous Data Module (ADM) is not attached to the station. When an ADM is attached, button 7 acts as a DATA button whether or not the data module has been administered. If the ADM has been administered, button 7 is set to DATA and access to the field is restricted. If the station is aliased as a 7505D or 7506D via Enhanced Terminal Administration, button 7 can be administered as a call appearance button whether or not an ADM is assigned. There is no Data button on 7507D, 8510T, and 8520T voice terminals.

Page 3 of X

STATION

|  |  |
|--|--|
| SITE DATA<br>Room: _____<br>Jack: _____<br>Cable: _____<br>Floor: _____<br>Building: _____ | Headset? n<br>Speaker? n<br>Mounting? d<br>Cord Length: 0_<br>Set Color: _____ |
|--|--|

|                     |              |              |              |
|---------------------|--------------|--------------|--------------|
| ABBREVIATED DIALING | List1: _____ | List2: _____ | List3: _____ |
|---------------------|--------------|--------------|--------------|

BUTTON ASSIGNMENTS

1: call-appr\_  
 2: call-appr\_  
 3: call-appr\_

Screen 6-74. 8503D Station form (Page 3 of X)

### ■ BUTTON ASSIGNMENTS

The feature buttons that you can assign to the 7505D, 7506D, 7507D, 8503D, 8510T, and 8520T voice terminals are listed below. The first 3 buttons default as call appearance.

|                           |                         |                          |                           |
|---------------------------|-------------------------|--------------------------|---------------------------|
| abr-prog                  | abr-spchar              | abrdg-appr               | abr-dial                  |
| abr-ring                  | ac-alarm                | aca-halt                 | after-call                |
| alrt-agchg                | alt-frl                 | assist                   | asvn-halt                 |
| atd-qcalls <sup>1</sup>   | atd-qtime               | aut-msg-wt               | auto-cback                |
| auto-icom                 | auto-in                 | auto-wkup <sup>1,2</sup> | autodial                  |
| aux-work                  | brdg-appr               | busy-ind                 | call-appr                 |
| call-disp <sup>1,2</sup>  | call-fwd                | call-park                | call-pkup                 |
| callr-info <sup>1,2</sup> | cas-backup              | cdr1-alm                 | cdr2-alm                  |
| cfwd-bsyda                | check-in <sup>1,2</sup> | check-out <sup>1,2</sup> | clk-overid <sup>1,2</sup> |



|                          |                           |                           |                           |
|--------------------------|---------------------------|---------------------------|---------------------------|
| consult                  | cov-cback                 | cov-msg-rt <sup>1,2</sup> | data-ext                  |
| date-time <sup>1,2</sup> | delete-msg <sup>1,2</sup> | dial-icom                 | directory <sup>1,2</sup>  |
| dir-pkup <sup>2</sup>    | disp-chrg <sup>2</sup>    | disp-norm <sup>1,2</sup>  | dn-dst                    |
| ds1-alarm                | exclusion                 | ext-dn-dst <sup>1,2</sup> | flash                     |
| goto-cover               | grp-dn-dst <sup>1,2</sup> | hunt-ns                   | in-call-id                |
| inspect <sup>1,2</sup>   | int-aut-an                | last-numb                 | link-alarm                |
| lsvn-halt                | lwc-cancel                | lwc-lock <sup>1,2</sup>   | lwc-store                 |
| major-alarm              | man-msg-wt                | man-overid <sup>1,2</sup> | manual-in                 |
| mct-act                  | mct-contr                 | mj/mn-alm                 | msg-retr <sup>1,2</sup>   |
| mwn-act <sup>1,2</sup>   | mwn-deact <sup>1,2</sup>  | next <sup>1,2</sup>       | night-serv                |
| noans-alm                | normal <sup>1,2</sup>     | per-COline                | pms-alarm                 |
| pr-awu-alm               | pr-pms-alm                | pr-sys-alm                | print-msgs                |
| priority                 | q-calls                   | q-time                    | release                   |
| ringer-off               | rs-alert                  | rsvn-halt                 | scroll <sup>2</sup>       |
| send-calls               | send-term                 | serv-obsrv                | signal                    |
| ssvn-halt                | stored-num <sup>1,2</sup> | stroke-cnt                | term-x-gr                 |
| timer <sup>1,2</sup>     | trk-ac-alm                | trk-id <sup>2</sup>       | trunk-name <sup>1,2</sup> |
| trunk-ns                 | verify                    | voa-repeat                | vu-display <sup>2</sup>   |
| work-code                |                           |                           |                           |

- 
1. Display-type button.
  2. Cannot administer on 7505D or 8503D.

**Page 4 of the form**

Page 4 of X

| FEATURE | BUTTON ASSIGNMENTS | STATION  |
|---------|--------------------|----------|
|         | 1: normal_____     | 4: _____ |
|         | 2: _____           | 5: _____ |
|         | 3: _____           | 6: _____ |
|         |                    | 7: _____ |

6 Voice Terminal, PC Interface, and Data Module Administration  
7505D, 7506D, 7507D, 8503D, 8510T, and 8520T ISDN-BRI voice terminals

Page 4 of X

| BUTTON ASSIGNMENTS | STATION         |
|--------------------|-----------------|
| 11: normal_____    | 20: _____       |
| 12: _____          | 21: normal_____ |
| 13: _____          | 22: _____       |
| 14: _____          | 23: _____       |
| 15: _____          | 24: _____       |
| 16: _____          | 25: _____       |
| 17: _____          | 26: _____       |
| 18: _____          | 27: _____       |
| 19: _____          | 28: _____       |
|                    | 29: _____       |
| 31: _____          | 30: _____       |
| 32: _____          |                 |
| 33: _____          | 37: _____       |
| 34: _____          | 38: _____       |
| 35: _____          | 39: _____       |
| 36: _____          | 40: _____       |

Screen 6-76. 7507D Station form (Page 4 of X)

Page 4 of X

| FEATURE BUTTON ASSIGNMENTS | STATION |
|----------------------------|---------|
| 11: normal                 |         |

Screen 6-77. 8510T Station form (Page 4 of X)

Page 4 of X

| BUTTON ASSIGNMENTS | STATION   |
|--------------------|-----------|
| 11: normal_____    | 16: _____ |
| 12: _____          | 17: _____ |
| 13: _____          | 18: _____ |
| 14: _____          | 19: _____ |
| 15: _____          | 20: _____ |

Screen 6-78. 8520T Station form (Page 4 of X)



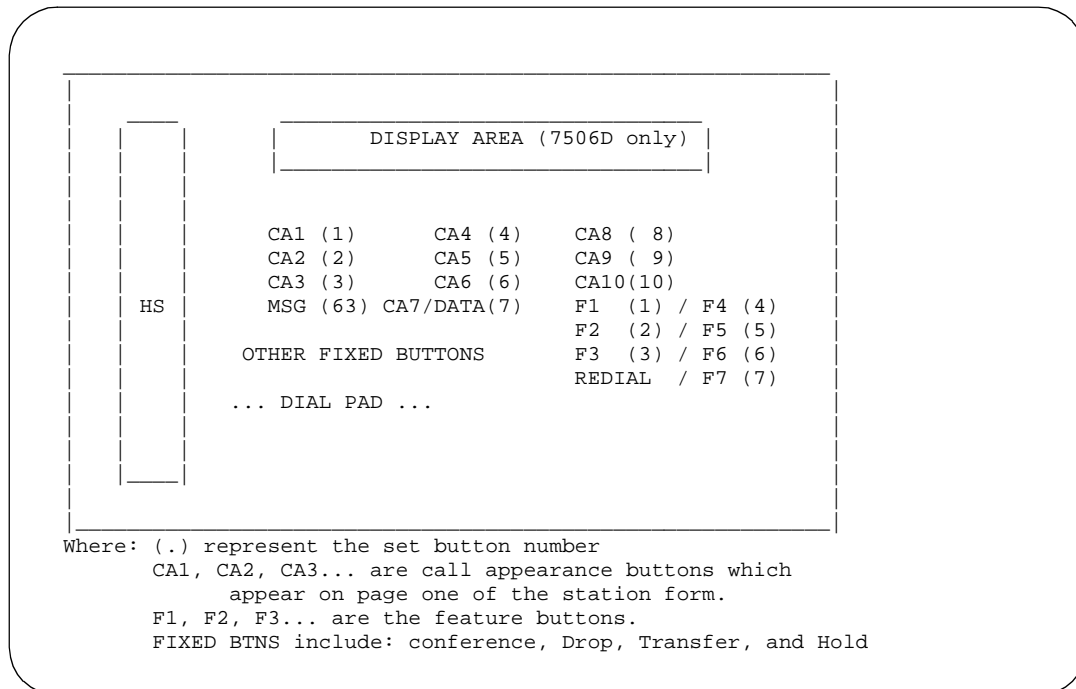

Screen 6-80. 7505D and 7506D voice-terminal feature button layout

**Notes:**

1. Buttons F4 through F6 are accessed by shifting buttons F1 through F3. Button F7 is accessed by shifting the fixed REDIAL button.
2. CA7/DATA button can be administered as a call appearance button. However, CA7 button should not be administered when ADM is attached to the terminal. When the ADM is attached, the button acts as a DATA button, regardless of administration. For 7505D and 7506D terminals, if ADM is administered, the CA7 button is set to DATA and the field is restricted. If a terminal is aliased as a 7505D or 7506D voice terminal via ETA, button CA7 is always administrable as a call appearance button, whether or not the data module is administered.

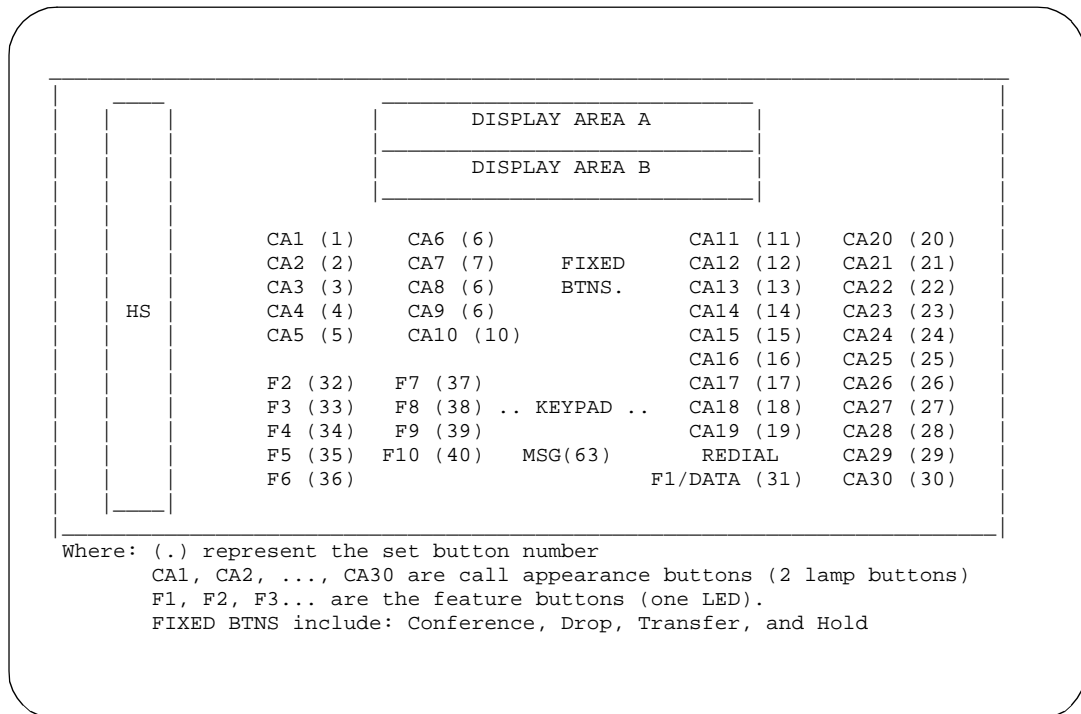

**Screen 6-81. 7507D Voice-terminal Feature button Layout**

**Notes:**

1. F1/DATA button can be administered as a feature button. However, F1 should not be administered if ADM is attached to the terminal. If the ADM is attached, F1 acts as a DATA button regardless of administration. For 7507D terminal, if ADM is administered, F1 is set to DATA and the field is restricted. If a terminal is aliased as 7507D via ETA, F1 button is always administrable as a feature button whether or not the data module is administered.
2. The 7507D terminal supports 31 buttons with two LEDs; however, the software only supports administration of 30 of these as call appearance buttons (buttons CA1-CA30). The system maximum of 10 call appearance buttons still applies. The CA1-CA30 buttons that are not used as call appearance buttons may be administered as bridged appearance buttons.

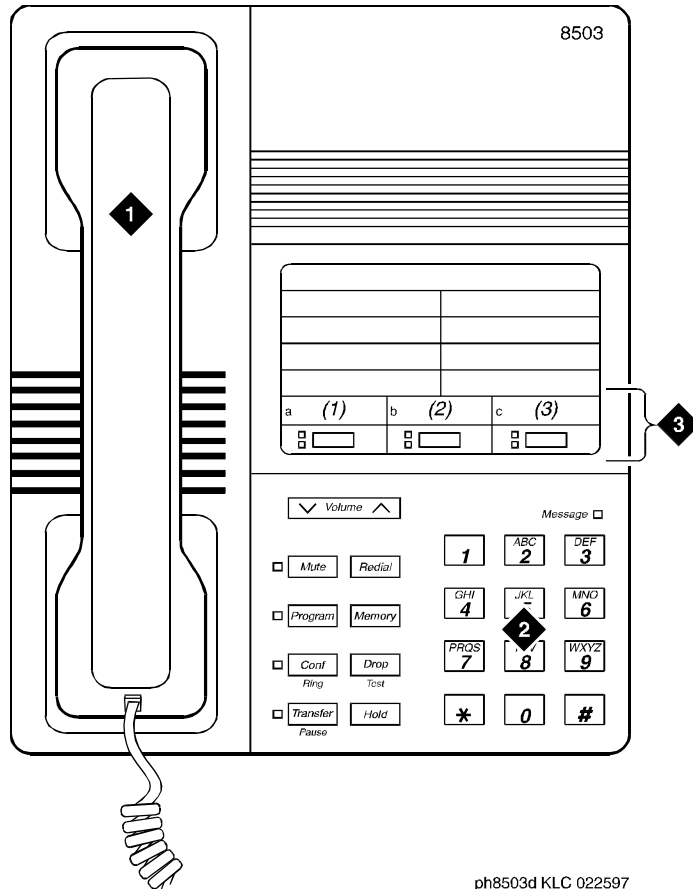

ph8503d KLC 022597

Figure Notes

- 1. Handset
- 2. Dial pad

- 3. 3 programmable buttons

Figure 6-38. 8503D Voice terminal

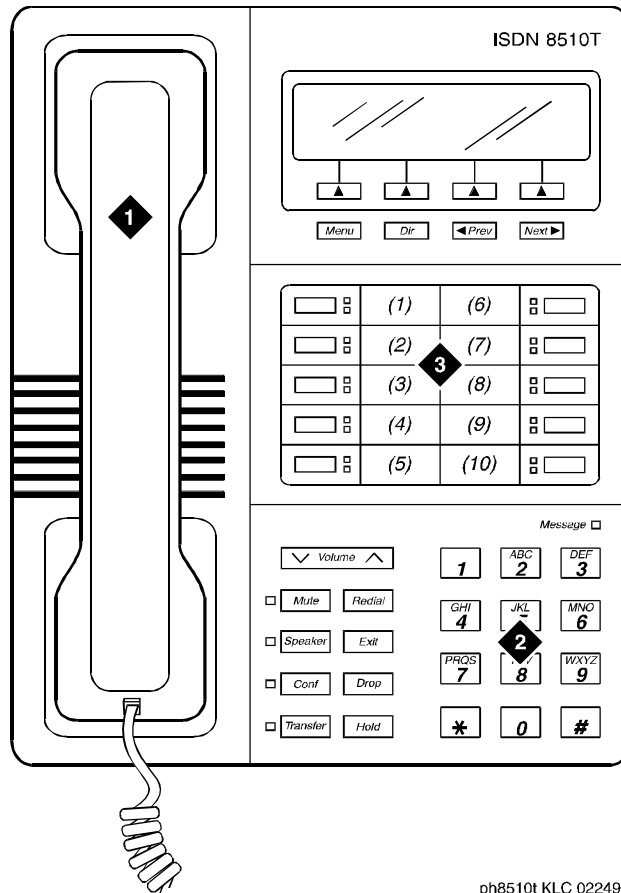

ph8510t KLC 022497

Figure Notes

- 1. Handset
- 2. Dial pad

- 3. 10 programmable buttons

Figure 6-39. 8510T Voice-terminal Feature Button Layout

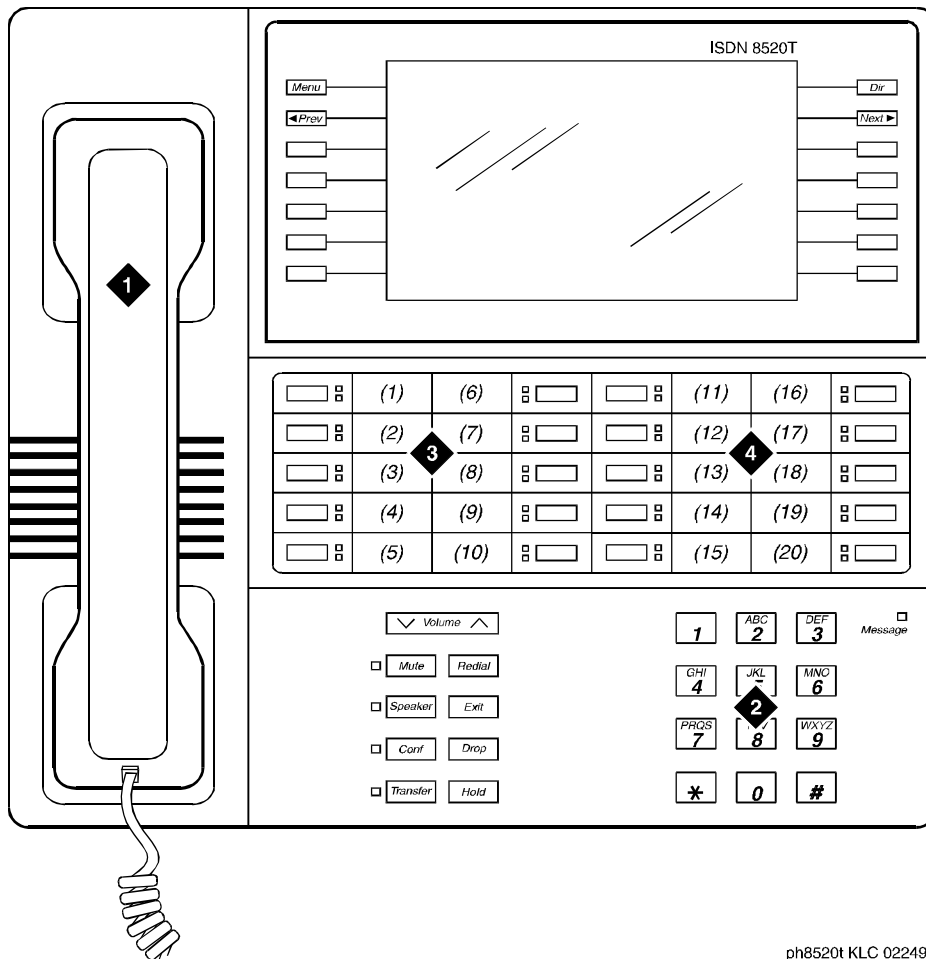

ph8520t KLC 022497

Figure Notes

- |   |   |
|---|---|
| <ul style="list-style-type: none"> <li>1. Handset</li> <li>2. Dial pad</li> </ul> | <ul style="list-style-type: none"> <li>3. 10 programmable buttons</li> <li>4. 10 programmable buttons (11 to 20)</li> </ul> |
|---|---|

Figure 6-40. 8520T station set layout

**NOTE:**

The 8520T terminal supports 20 call appearances. The system maximum of 10 call appearance buttons still applies. The (1)–(20) buttons that are not used as call appearance buttons can be administered as bridged appearance buttons.



## CALLMASTER II and III voice terminals

---

The CALLMASTER II and CALLMASTER III voice terminals provide internal nonvolatile memory and native support. Native support means the switch stores a predefined terminal type and automatically downloads the terminal type information to the terminal.

These enhancements provide several benefits. First, the internal nonvolatile memory of the terminal stores information even if the terminal loses power. Second, native support removes from the customer or service technician the burden of having to alias the terminals, that is — manually map call appearance and feature buttons onto some other supported terminal type. Also, the nonvolatile memory can support transmission changes for applications in various countries.

The 603-type CALLMASTER voice terminal is available in three models: 603A1, 603D1, and 603E1. The only difference among these three is the ability of the 603D1 to tape recording equipment and of the 603E1 to operate on either the standard 4-wire DCP circuit pack or on a 2-wire circuit pack (16-port, A-law/Mu-law selectable).

### NOTE:

The 603s must have their handset unplugged to receive the downloaded parameters.

You can check `Download Status` on the Status Station screen to verify that the system successfully completes each download. You do not need to download the information to the terminals, as the switch does it automatically after the initialization period during the first periodic maintenance cycle.

## Form instructions

---

To administer a 603 CALLMASTER voice terminal, complete the standard as well as the following unique Station form fields.

### NOTE:

If you have one or more 603-type CALLMASTER voice terminals, you must also have a Lucent technician complete the Terminal Parameters form (see [“Terminal Parameters form” on page 6-9](#)). Only Lucent technicians can complete this form.

Page 1 of the form

```

                                                    Page 1 of X
                                STATION

Extension: 1003                                Lock Messages? n                BCC: 0
Type: 603A1__                                Security Code: _____      TN: 1_
Port: _____                            Coverage Path 1: _____     COR: 1_
Name: _____                            Coverage Path 2: _____     COS: 1_
                                           Hunt-to Station: _____

STATION OPTIONS
    Data Module? n                            Personalized Ringing Pattern: 1
    Display Module? y                        Message Lamp Ext: 1000
    Display Language: english
                                           MM Complex Data Ext: _____
    
```

Screen 6-82. 603A1, 603D1, and 603E1 Station form (Page 1 of X)

- **Type** — Enter **603A1**, **603D1**, or **603E1**.
- **Data Module** — Enter **y** if this terminal is connected to a data terminal via 7400B or 8400B Data Module. If you enter **y**, you must complete the Data Module form. Default is **n**.
- **Display Module** — Display-only field set to **y**. You must administer the display-type buttons on page 3 of the form.

Page 2 of the form

```

                                                    Page 2 of X
                                STATION

FEATURE OPTIONS
    LWC Reception? msa-spe                    Auto Select Any Idle Appearance? n
    LWC Activation? y                        Coverage Msg Retrieval? y
    CDR Privacy? n                          Auto Answer: none
    Redirect Notification? y                 Data Restriction? n
    Per Button Ring Control? n              Idle Appearance Preference? n
    Bridged Call Alerting? n                Restrict Last Appearance? y
    Active Station Ringing: single

    H.320 Conversion? n
    AUDIX Name: _____
    Messaging Server Name: _____
                                           Multimedia Early Answer? n
                                           Audible Message Waiting? y
                                           Display Client Redirection? n
                                           Select Last Used Appearance? n
    
```

Screen 6-83. 603A1, 603D1, and 603E1 Station form (Page 2 of X)

Page 3 of the form

Page 3 of X

STATION

|  |  |
|--|--|
| SITE DATA<br>Room: _____<br>Jack: _____<br>Cable: _____<br>Floor: _____<br>Building: _____ | Headset? n<br>Speaker? n<br>Mounting: d<br>Cord Length: 0_<br>Set Color: _____ |
|--|--|

|                     |              |              |
|---------------------|--------------|--------------|
| ABBREVIATED DIALING | List2: _____ | List3: _____ |
| List1: _____        |              |              |

|                    |          |
|--------------------|----------|
| BUTTON ASSIGNMENTS |          |
| 1: call-appr_      | 4: _____ |
| 2: call-appr_      | 5: _____ |
| 3: call-appr_      | 6: _____ |

Screen 6-84. 603A1, 603D1, and 603E1 Station form (Page 3 of X)

■ **BUTTON ASSIGNMENTS**

The feature buttons that you can assign to the CALLMASTER digital voice terminal are listed below.

|                         |                         |                         |                         |
|-------------------------|-------------------------|-------------------------|-------------------------|
| abr-prog                | abr-spchar              | abrdg-appr              | abrv-dial               |
| abrv-ring               | ac-alarm                | aca-halt                | after-call              |
| alrt-agchg              | alt-frl                 | assist                  | asvn-halt               |
| atd-qcalls <sup>1</sup> | atd-qtime <sup>1</sup>  | aut-msg-wt              | auto-cback              |
| auto-icom               | auto-in                 | auto-wkup <sup>1</sup>  | autodial                |
| aux-work                | brdg-appr               | busy-ind                | call-appr               |
| call-disp               | call-fwd                | call-park               | call-pkup               |
| callr-info <sup>1</sup> | cas-backup              | cdr1-almr               | cdr2-almr               |
| cfwd-bsyda              | check-in <sup>1</sup>   | check-out <sup>1</sup>  | clk-overid <sup>1</sup> |
| consult                 | cov-cback               | cov-msg-rt <sup>1</sup> | data-ext                |
| date-time <sup>1</sup>  | delete-msg <sup>1</sup> | dial-icom               | directory <sup>1</sup>  |
| dir-pkup                | disp-chrg               | disp-norm               | dn-dst                  |
| ds1-alarm               | exclusion               | ext-dn-dst <sup>1</sup> | flash                   |
| goto-cover              | grp-dn-dst <sup>1</sup> | hunt-ns                 | in-call-id              |

*Continued on next page*

|                      |                         |                         |                         |
|----------------------|-------------------------|-------------------------|-------------------------|
| inspect <sup>1</sup> | int-aut-an              | last-numb               | link-alarm              |
| lsvn-halt            | lwc-cancel              | lwc-lock                | lwc-store               |
| major-alm            | man-msg-wt              | man-overid <sup>1</sup> | manual-in               |
| mct-act              | mct-contr               | mf-da-intl              | mf-op-intl              |
| mj/mn-alm            | msg-retr <sup>1</sup>   | mwn-act <sup>1</sup>    | mwn-deact <sup>1</sup>  |
| next <sup>1</sup>    | night-serv              | noans-alm               | normal <sup>1</sup>     |
| per-COline           | pms-alarm               | pr-awu-alm              | pr-pms-alm              |
| pr-sys-alm           | print-msgs              | priority                | q-calls                 |
| q-time               | release                 | ringer-off              | rs-alert                |
| rsvn-halt            | scroll                  | send-calls              | send-term               |
| serv-obsrv           | signal                  | ssvn-halt               | stored-num <sup>1</sup> |
| stroke-cnt           | term-x-gr               | timer <sup>1</sup>      | trk-ac-alm              |
| trk-id               | trunk-name <sup>1</sup> | trunk-ns                | verify                  |
| voa-repeat           | vu-display              | work-code               |                         |

---

1. Requires display.

---

Page 4 of the form

Page 4 of X

STATION

| FEATURE BUTTON ASSIGNMENTS | 1st Column    | 2nd Column     |
|----------------------------|---------------|----------------|
|                            | 1: normal____ | 7: _____       |
|                            | 2: _____      | 8: _____       |
|                            | 3: _____      | 9: _____       |
|                            | 4: _____      | 10: _____      |
|                            | 5: _____      | 11: normal____ |
|                            | 6: mute       | 12: _____      |
|                            | 3rd Column    |                |
|                            | 13: _____     |                |
|                            | 14: _____     |                |
|                            | 15: _____     |                |
|                            | 16: _____     |                |
|                            | 17: _____     |                |
|                            | 18: Release   |                |

■ **FEATURE BUTTON ASSIGNMENTS**

The features and functions that you can assign to the terminal's administrable buttons are the same as those for BUTTON ASSIGNMENTS above.

Feature button 6 is preassigned as mute and button 18 is preassigned as release (they are not administrable). Feature button 12 is already labeled on the terminal as a login button, but you must still administer it as a login button.

**Page 5 of the form (DATA MODULE)**

Page Y of X

STATION

DATA MODULE

|                       |             |        |
|-----------------------|-------------|--------|
| Data Extension: _____ | Name: _____ | BCC: 2 |
|                       | COS: 1_     |        |
|                       | COR: 1_     |        |
| ITC: restricted       | TN: 1_      |        |

ABBREVIATED DIALING  
List1: \_\_\_\_\_

SPECIAL DIALING OPTION: hot-line  
HOT LINE DESTINATION  
DEFAULT DIALING  
Abbreviated Dialing Dial Code (From above list): \_\_\_\_

ASSIGNED MEMBER (Station with a data extension button for this data module)

| Ext      | Name  |
|----------|-------|
| 1. _____ | _____ |

**Screen 6-86. 603A1, 603D1, and 603E1 Data Module form (Page Y of X)**

This page displays only if Data Module is **y**.

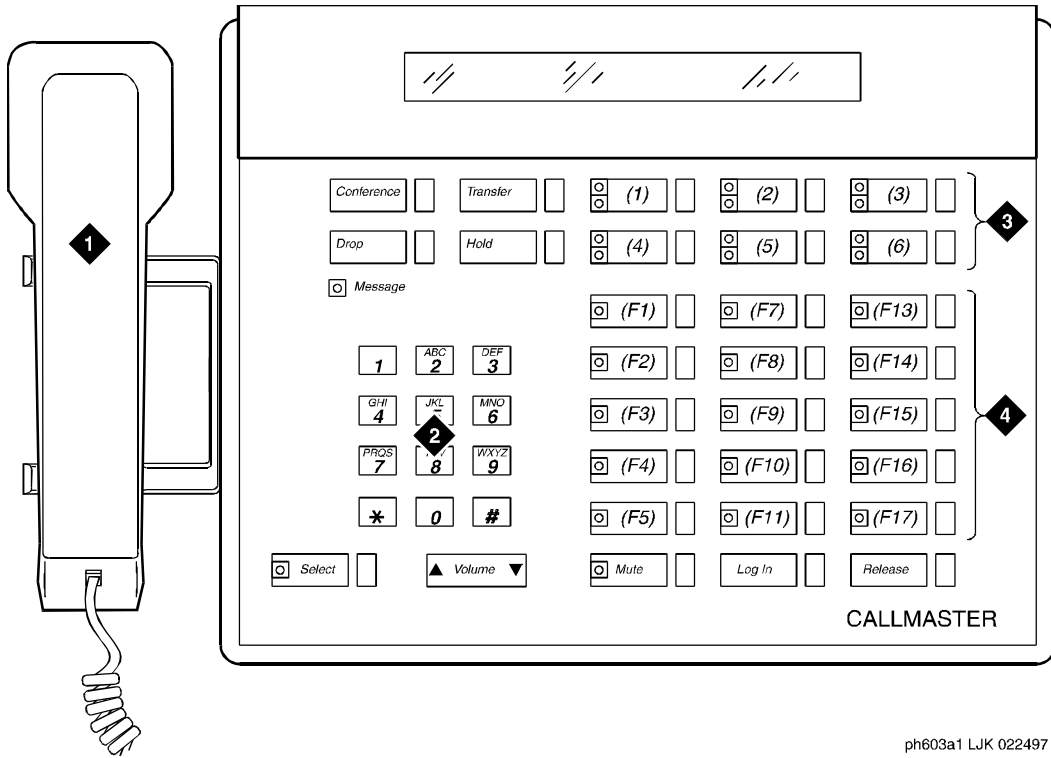

ph603a1 LJK 022497

Figure Notes

- 1. Handset
- 2. Dial pad

- 3. 6 programmable buttons
- 4. 18 feature buttons

Figure 6-41. 603A1 and 603D1 CALLMASTER II digital voice terminals

## CALLMASTER VI voice terminal

The CALLMASTER VI (606) terminal is a miniature, 8-button, 2-headset jack, digital voice terminal that is controlled by the user's personal computer (PC) through an RS-232 serial-port connection.

### Form instructions

To administer a CALLMASTER VI voice terminal, complete the standard as well as the following unique Station form fields.

#### ⇒ NOTE:

If you have one or more 606-type CALLMASTER voice terminals, you must also have a Lucent technician complete the [“Terminal Parameters form”](#) (see [6-9](#)). Only Lucent technicians can complete this form.

### Page 1 of the form

|                           |                                 |                            |
|---------------------------|---------------------------------|----------------------------|
|                           |                                 | Page 1 of X                |
| STATION                   |                                 |                            |
| Extension: xxxx           | x Lock Messages? n              | BCC: 0                     |
| Type: 606A1__             | Security Code: _____            | TN: 1_                     |
| Port: _____               | Coverage Path 1: _____          | COR: 1_                    |
| Name: _____               | Coverage Path 2: _____          | COS: 1_                    |
|                           | Hunt-to Station: _____          |                            |
| STATION OPTIONS           |                                 |                            |
| Data Module? n            | Personalized Ringing Pattern: 1 | Message Lamp Ext: 1000     |
| Display Language: english |                                 | MM Complex Data Ext: _____ |

### Screen 6-87. 606A1 Station form (Page 1 of X)

- **Type** — Enter **606A1**.
- **Data Module** — Enter **y** if this terminal is connected to a data terminal via a 8400B+ data module. If you enter **y**, you must complete the Data Module form. Default is **n**.

Page 2 of the form

|                             |                                    |             |
|-----------------------------|------------------------------------|-------------|
|                             |                                    | Page 2 of X |
| FEATURE OPTIONS             | STATION                            |             |
| LWC Reception? msa-spe      | Auto Select Any Idle Appearance? n |             |
| LWC Activation? y           | Coverage Msg Retrieval? y          |             |
| CDR Privacy? n              | Auto Answer: none                  |             |
| Redirect Notification? y    | Data Restriction? n                |             |
| Per Button Ring Control? n  | Idle Appearance Preference? n      |             |
| Bridged Call Alerting? n    |                                    |             |
| Idle/Active Ringing: single | Restrict Last Appearance? y        |             |
|                             |                                    |             |
| H.320 Conversion? n         | Multimedia Early Answer? n         |             |
|                             | Audible Message Waiting? y         |             |
|                             | Display Client Redirection? n      |             |
|                             | Select Last Used Appearance? n     |             |

Screen 6-88. 606A1 Station form (Page 2 of X)

■ PHYSICAL ENTITIES

The feature buttons that you can assign to the CALLMASTER VI digital voice terminal are listed below.

|            |            |            |            |
|------------|------------|------------|------------|
| abr-prog   | abr-spchar | abrdg-appr | abrv-dial  |
| abrv-ring  | ac-alarm   | aca-halt   | after-call |
| alrt-agchg | alt-frl    | assist     | asvn-halt  |
| atd-qcalls | atd-qtime  | aut-msg-wt | auto-cback |
| auto-icom  | auto-in    | auto-wkup  | autodial   |
| aux-work   | brdg-appr  | busy-ind   | call-appr  |
| call-disp  | call-fwd   | call-park  | call-pkup  |
| callr-info | cas-backup | cdr1-alm   | cdr2-alm   |
| cfwd-bsyda | check-in   | check-out  | clk-overid |
| consult    | cov-cback  | cov-msg-rt | data-ext   |
| date-time  | delete-msg | dial-icom  | directory  |
| dir-pkup   | disp-chrg  | disp-norm  | dn-dst     |
| ds1-alarm  | exclusion  | ext-dn-dst | flash      |
| goto-cover | grp-dn-dst | hunt-ns    | in-call-id |
| inspect    | int-aut-an | last-numb  | link-alarm |

Continued on next page



|            |            |            |            |
|------------|------------|------------|------------|
| lsvn-halt  | lwc-cancel | lwc-lock   | lwc-store  |
| major-alm  | man-msg-wt | man-overid | manual-in  |
| mct-act    | mct-contr  | mf-da-intl | mf-op-intl |
| mj/mn-alm  | msg-retr   | mwn-act    | mwn-deact  |
| next       | night-serv | noans-ahrt | normal     |
| per-COLine | pms-alarm  | pr-awu-alm | pr-pms-alm |
| pr-sys-alm | print-msgs | priority   | q-calls    |
| q-time     | release    | ringer-off | rs-alert   |
| rsvn-halt  | scroll     | send-calls | send-term  |
| serv-obsrv | signal     | ssvn-halt  | stored-num |
| stroke-cnt | term-x-gr  | timer      | trk-ac-alm |
| trk-id     | trunk-name | trunk-ns   | uui-info   |
| verify     | voa-repeat | vu-display | work-code  |

Page 3 of the form

Page 3 of X

STATION

SITE DATA

Room: \_\_\_\_\_ Headset? n

Jack: \_\_\_\_\_ Speaker? n

Cable: \_\_\_\_\_ Mounting: d

Floor: \_\_\_\_\_ Cord Length: 0\_

Building: \_\_\_\_\_ Set Color: \_\_\_\_\_

ABBREVIATED DIALING

List1: \_\_\_\_\_ List2: \_\_\_\_\_ List3: \_\_\_\_\_

PHYSICAL ENTITIES

NO LED: abr-v-dial List: 0 DC: \_\_\_\_\_

GREEN LED: call-appr

GREEN LED: call-appr

button: switchhook

RED LED: switchhook/mutelamp

button: mute

RED LED: msg-waiting lamp

DAUL LED: call-appr

DUAL LED: call-appr

RED LED: release



Page 6 of X

VIRTUAL BUTTONS with GREEN LED (o)

|          |            |
|----------|------------|
| o: _____ | o: _____   |
| o: _____ | o: _____   |
| o: _____ | o: _____   |
| o: _____ | o: _____   |
| o: _____ | o: _____   |
| o: _____ | o: _____   |
| o: _____ | o: _____   |
| o: _____ | o: _____   |
| o: _____ | o: inspect |
| o: _____ | o: next    |
| o: _____ | o: normal_ |

Screen 6-92. 606A1 Station form (Page 6 of X)

Page 7 of the form (DATA MODULE)

Page Y of X

DATA MODULE

STATION

Data Extension: \_\_\_\_\_ Name: \_\_\_\_\_ BCC: 2

COS: 1\_

COR: 1\_

ITC: restricted TN: 1\_

ABBREVIATED DIALING

List1: \_\_\_\_\_

SPECIAL DIALING OPTION: hot-line

HOT LINE DESTINATION

DEFAULT DIALING

Abbreviated Dialing Dial Code (From above list): \_\_\_\_

ASSIGNED MEMBER (Station with a data extension button for this data module)

| Ext      | Name  |
|----------|-------|
| 1. _____ | _____ |

Screen 6-93. 606A1 Data Module form (Page Y of X)

This page displays only if Data Module is y.

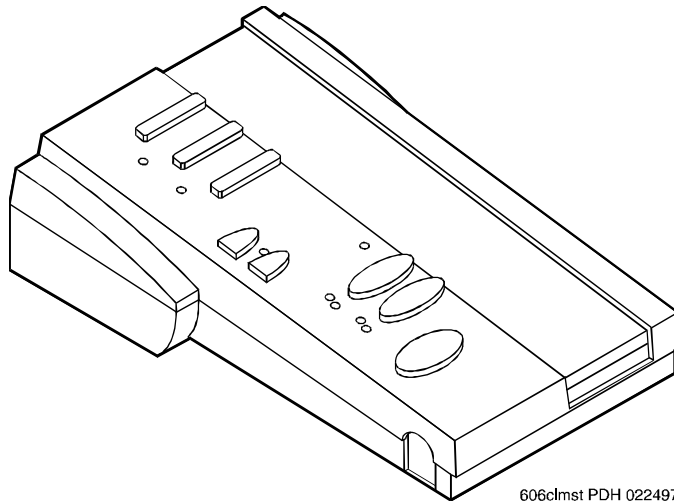

---

**Figure 6-42.** 606A1 CALLMASTER voice terminal

## Personal Computer

The personal computer (PC) must be an IBM-compatible PC that can be used with a 7400D series voice terminal to form a workstation arrangement.

### Form instructions

To administer a personal computer with a 7400D series terminal, complete the standard as well as the following unique Station form fields.

### Page 1 of the form

Page 1 of X

STATION

|                       |                        |         |
|-----------------------|------------------------|---------|
| Extension: 1003       | Lock Messages? n       | BCC: 0  |
| Type: PC___Set: 7401D | Security Code: _____   | TN: 1_  |
| Port: _____           | Coverage Path 1: _____ | COR: 1_ |
| Name: _____           | Coverage Path 2: _____ | COS: 1_ |
|                       | Hunt-to Station: _____ |         |

STATION OPTIONS

|                           |                            |
|---------------------------|----------------------------|
| Data Module? y            | Message Lamp Ext: 1000     |
| Display Module? y         |                            |
| Display Language: english | MM Complex Data Ext: _____ |

### Screen 6-94. PC Station form (Page 1 of X)

- **Type** — Enter **pc**.
- **Set** — Enter the digital voice terminal type the PC is connected to (7401D, 7401+, 7403D, 7404D, 7405D, 7406D, 7406+, 7407D, 7407+, 7410D, 7410+, 7434D, or 7444D).
- **Data Module** — Display-only (set to y).
- **Display Module** — Display-only (set to y).

### Page 2 of the form

```

                                                                 Page 2 of X
                                STATION
FEATURE OPTIONS
    LWC Reception? msa-spe           Auto Select Any Idle Appearance? n
    LWC Activation? y                Coverage Msg Retrieval? y
    CDR Privacy? n                   Auto Answer: none
    Redirect Notification? y         Data Restriction? n
    Per Button Ring Control? n      Idle Appearance Preference? n
    PCOL\TEG Call Alerting? n
    Active Station Ringing: single   Restrict Last Appearance? y

    H.320 Conversion? n
    AUDIX Name: _____          Multimedia Early Answer? n
    Messaging Server Name: _____ Audible Message Waiting? n
                                        Display Client Redirection? n
                                        Select Last Used Appearance? n
```

Screen 6-95. PC Station form (Page 2 of X)

### Page 3 of the form

```

                                                                 Page 3 of X
                                STATION
SITE DATA
    Room: _____                Headset? n
    Jack: _____                 Speaker? n
    Cable: _____                Mounting: d
    Floor: _____                Cord Length: 0_
    Building: _____              Set Color: _____

ABBREVIATED DIALING
    List1: _____                List2: _____                List3: _____

BUTTON ASSIGNMENTS
    1: call-appr_ (F1)              6: _____ (AF3)
    2: call-appr_ (F3)              7: _____ (AF5)
    3: call-appr_ (F5)              8: _____ (AF7)
    4: call-appr_ (F7)              9: _____ (AF2)
    5: _____ (AF1)              10: _____ (AF4)
```

Screen 6-96. PC Station form (Page 3 of X)

**⇒ NOTE:**

Characters in parenthesis (F1), (F2), and so on represent button locations on the PC and do not appear on the page 3 of the form.

## ■ BUTTON ASSIGNMENTS

The feature buttons that you can assign to the associated voice terminal are listed below. Call appearance buttons (call-appr, brdg-appr, abrdg-appr) should only be administered in BUTTON ASSIGNMENTS fields 1 through 4.

|                         |                         |                         |                         |
|-------------------------|-------------------------|-------------------------|-------------------------|
| abr-prog                | abr-spchar              | abrdg-appr              | abrv-dial               |
| abrv-ring               | ac-alarm                | aca-halt                | after-call              |
| alrt-agchg              | alt-frl                 | assist                  | asvn-halt               |
| atd-qcalls <sup>1</sup> | atd-qtime <sup>1</sup>  | aut-msg-wt              | auto-cback              |
| auto-icom               | auto-in                 | auto-wkup <sup>1</sup>  | autodial                |
| aux-work                | brdg-appr               | busy-ind                | call-appr               |
| call-disp <sup>1</sup>  | call-fwd                | call-park               | call-pkup               |
| callr-info <sup>1</sup> | cas-backup              | cdr1-alm                | cdr2-alm                |
| cfwd-bsyda              | check-in <sup>1</sup>   | check-out <sup>1</sup>  | clk-overid <sup>1</sup> |
| consult                 | cov-cback               | cov-msg-rt <sup>1</sup> | data-ext                |
| date-time <sup>1</sup>  | delete-msg <sup>1</sup> | dial-icom               | directory <sup>1</sup>  |
| dir-pkup                | disp-chrg               | disp-norm               | dn-dst                  |
| ds1-alarm               | exclusion               | ext-dn-dst <sup>1</sup> | flash                   |
| goto-cover              | grp-dn-dst <sup>1</sup> | hunt-ns                 | in-call-id              |
| inspect <sup>1</sup>    | int-aut-an              | last-numb               | link-alarm              |
| lsvn-halt               | lwc-cancel              | lwc-lock                | lwc-store               |
| major-alm               | man-msg-wt              | man-overid <sup>1</sup> | manual-in               |
| mct-act                 | mct-contr               | mj/mn-alm               | msg-retr <sup>1</sup>   |
| mwn-act <sup>1</sup>    | mwn-deact <sup>1</sup>  | next <sup>1</sup>       | night-serv              |
| noans-alrt              | normal <sup>1</sup>     | per-COline              | pms-alarm               |
| pr-awu-alm              | pr-pms-alm              | pr-sys-alm              | print-msgs              |
| priority                | q-calls                 | q-time                  | release                 |
| ringer-off              | rs-alert                | rsvn-halt               | scroll                  |
| send-calls              | send-term               | serv-obsrv              | signal                  |
| ssvn-halt               | stored-num <sup>1</sup> | stroke-cnt              | term-x-gr               |

*Continued on next page*

|                    |            |            |                         |
|--------------------|------------|------------|-------------------------|
| timer <sup>1</sup> | trk-ac-alm | trk-id     | trunk-name <sup>1</sup> |
| trunk-ns           | verify     | voa-repeat | vu-display              |
| work-code          |            |            |                         |

- 
1. Display-type buttons
- 

### Page 4 of the form

Page 4 of X

| FEATURE BUTTON ASSIGNMENTS | STATION          |
|----------------------------|------------------|
| 1: normal_____             | 13: _____        |
| 2: _____                   | 14: _____        |
| 3: _____                   | 15: _____        |
| 4: _____                   | 16: _____        |
| 5: _____                   | 17: _____        |
| 6: _____                   | 18: release_____ |
| 7: _____                   | 19: _____        |
| 8: _____                   | 20: _____        |
| 9: _____                   | 21: _____        |
| 10: _____                  | 22: _____        |
| 11: normal_____            | 23: _____        |
| 12: _____                  | 24: _____        |

Screen 6-97. PC Station form (Page 4 of X)

#### ■ FEATURE BUTTON ASSIGNMENTS

The feature buttons that can be administered are the same as those for BUTTON ASSIGNMENTS above.



### Page X of the form (DISPLAY BUTTON ASSIGNMENTS)

Page Y of X

STATION

DISPLAY BUTTON ASSIGNMENTS

1: \_\_\_\_\_ (CF1)  
2: \_\_\_\_\_ (CF2)  
3: \_\_\_\_\_ (CF3)  
4: \_\_\_\_\_ (CF4)  
5: \_\_\_\_\_ (CF5)  
6: \_\_\_\_\_ (leave blank)  
7: \_\_\_\_\_ (leave blank)

### Screen 6-98. PC Station form (Page Y of X)

Administer display-type buttons as required. Display-type buttons are noted on the above BUTTON ASSIGNMENTS list.

### Page X of the form (DATA MODULE)

Page Y of X

STATION

DATA MODULE

Data Extension: \_\_\_\_\_ Name: \_\_\_\_\_ BCC: 2  
COS: 1\_  
COR: 1\_  
ITC: restricted TN: 1\_

ABBREVIATED DIALING  
List1: \_\_\_\_\_

SPECIAL DIALING OPTION: hot-line  
HOT LINE DESTINATION  
Abbreviated Dialing Dial Code (From above list): \_\_\_\_

ASSIGNED MEMBER (Station with a data extension button for this data module)

| Ext      | Name  |
|----------|-------|
| 1. _____ | _____ |

### Screen 6-99. PC Data Module form (Page Y of X)

Complete the Data Module fields as required.

## Constellation voice/data terminals

The Constellation voice/ data terminal is a workstation that provides an integrated environment for applications using digital communications protocol (DCP) signaling. It operates in conjunction with a voice terminal.

The Constellation terminal provides enhanced capability for a telemarketing environment. It interacts with the switch and a host computer to provide agents with information about the calling and called party. The terminal interprets information about a call, passes the information to a host computer, and receives information from the host. Information sent by the host appears on the terminal monitor.

### Form instructions

To administer a Constellation voice/data terminal, complete the standard as well as the following unique Station form fields.

#### ⇒ NOTE:

The fields that display depend on what you enter in the *Set* field, because each terminal requires different administration. The form included in this section displays when you set the *Set* field to 7401D. Please refer to the individual terminal forms to determine which fields display for each *Set* type.

### Page 1 of the form

```

                                     STATION                                     Page 1 of X
Extension: 1003                               Lock Messages? n                BCC: 0
Type: PC__Set: 7401D                          Security Code: _____          TN: 1_
Port: _____                               Coverage Path 1: _____        COR: 1_
Name: _____                               Coverage Path 2: _____        COS: 1_
                                             Hunt-to Station: _____

STATION OPTIONS
      Data Module? y
      Display Module? y
      Display Language: english
                                             Message Lamp Ext: 1000
```

### Screen 6-100. Constellation Station form, for default 7401D terminal (Page 1 of X)

- **Type** — Enter **6538**.
- **Set** — Enter the digital voice terminal type the PC is connected to (7401D, 7406D, 602A1, 603A1, 603D1, or 603E1).

- **Data Module** — Display-only (set to y).
- **Display Module** — Display-only (set to y).

### Page 2 of the form

```

                                                                 Page 2 of X
                                STATION
FEATURE OPTIONS
    LWC Reception? msa-spe          Auto Select Any Idle Appearance? n
    LWC Activation? y                Coverage Msg Retrieval? y
    CDR Privacy? n                  Auto Answer: none
    Redirect Notification? y         Data Restriction? n
    Per Button Ring Control? n      Idle Appearance Preference? n
    Bridged Call Alerting? n
    Active Station Ringing: single   Restrict Last Appearance? y

    H.320 Conversion? n
    AUDIX Name: _____          Multimedia Early Answer? n
    Messaging Server Name: _____ Audible Message Waiting? n
                                        Display Client Redirection? n
                                        Select Last Used Appearance? n
```

Screen 6-101. Constellation Station form, for default 7401D terminal (Page 2 of X)

### Page 3 of the form

```

                                                                 Page 3 of X
                                STATION
SITE DATA
    Room: _____                Headset? n
    Jack: _____                 Speaker? n
    Cable: _____                Mounting? d
    Floor: _____                Cord Length: 0_
    Building: _____             Set Color: _____
ABBREVIATED DIALING
    List1: _____               List2: _____           List3: _____
BUTTON ASSIGNMENTS
    1: call-appr_                 6: _____
    2: call-appr_                 7: _____
    3: call-appr_                 8: _____
    4: call-appr_                 9: _____
    5: _____ (AF1)
```

Screen 6-102. Constellation voice/terminal Station form (Page 3 of X)

## ■ BUTTON ASSIGNMENTS

The feature buttons that you can assign to the associated voice terminal are dependent on the terminal you are administering with the constellation and are listed below. You should only administer call appearance buttons (call-appr, brdg-appr, abrdg-appr) in BUTTON ASSIGNMENTS fields 1 through 4.

|                         |                         |                         |                         |
|-------------------------|-------------------------|-------------------------|-------------------------|
| abr-prog                | abr-spchar              | abrdg-appr              | abrv-dial               |
| abrv-ring               | ac-alarm                | aca-halt                | after-call              |
| alrt-agchg              | alt-frl                 | assist                  | asvn-halt               |
| atd-qcalls <sup>1</sup> | atd-qtime <sup>1</sup>  | aut-msg-wt              | auto-cback              |
| auto-icom               | auto-in                 | auto-wkup <sup>1</sup>  | autodial                |
| aux-work                | brdg-appr               | busy-ind                | call-appr               |
| call-disp <sup>1</sup>  | call-fwd                | call-park               | call-pkup               |
| callr-info <sup>1</sup> | cas-backup              | cdr1-alm                | cdr2-alm                |
| cfwd-bsyda              | check-in <sup>1</sup>   | check-out <sup>1</sup>  | clk-overid <sup>1</sup> |
| consult                 | cov-cback               | cov-msg-rt <sup>1</sup> | data-ext                |
| date-time <sup>1</sup>  | delete-msg <sup>1</sup> | dial-icom               | directory <sup>1</sup>  |
| dir-pkup                | disp-chrg               | disp-norm               | dn-dst                  |
| ds1-alarm               | exclusion               | ext-dn-dst <sup>1</sup> | flash                   |
| goto-cover              | grp-dn-dst <sup>1</sup> | hunt-ns                 | in-call-id              |
| inspect <sup>1</sup>    | int-aut-an              | last-numb               | link-alarm              |
| lsvn-halt               | lwc-cancel              | lwc-lock                | lwc-store               |
| major-alm               | man-msg-wt              | man-overid <sup>1</sup> | manual-in               |
| mct-act                 | mct-contr               | mj/mn-alm               | msg-retr <sup>1</sup>   |
| mwn-act <sup>1</sup>    | mwn-deact <sup>1</sup>  | next <sup>1</sup>       | night-serv              |
| noans-alrt              | normal <sup>1</sup>     | per-COline              | pms-alarm               |
| pr-awu-alm              | pr-pms-alm              | pr-sys-alm              | print-msgs              |
| priority                | q-calls                 | q-time                  | release                 |
| ringer-off              | rs-alert                | rsvn-halt               | scroll                  |
| send-calls              | send-term               | serv-obsrv              | signal                  |
| ssvn-halt               | stored-num <sup>1</sup> | stroke-cnt              | term-x-gr               |

timer<sup>1</sup>            trk-ac-alm        trk-id            trunk-name<sup>1</sup>  
trunk-ns        verify            voa-repeat        vu-display  
work-code

- 
1. Display-type buttons

## Page 4 of the form

### ■ FEATURE BUTTON ASSIGNMENTS

The feature buttons that can be administered are the same as those for BUTTON ASSIGNMENTS above.

## Page X of the form (DATA MODULE)

Page Y of X

| DATA MODULE   | STATION            |
|---|--------------------|
| Data Extension: _____   | Name: _____ BCC: 2 |
|   | COS: 1_            |
|   | COR: 1_            |
| ITC: restricted   | TN: 1_             |
| ABBREVIATED DIALING   |                    |
| List1: _____  |                    |
| SPECIAL DIALING OPTION: _____   |                    |
| HOT LINE DESTINATION  |                    |
| DEFAULT DIALING   |                    |
| Abbreviated Dialing Dial Code (From above list): _                            |                    |
| ASSIGNED MEMBER ( Station with a data extension button for this data module ) |                    |
| Ext            Name   |                    |
| 1:  |                    |

## Screen 6-103. Constellation Data Module form (Page Y of X)

Complete the Data Module fields as required.

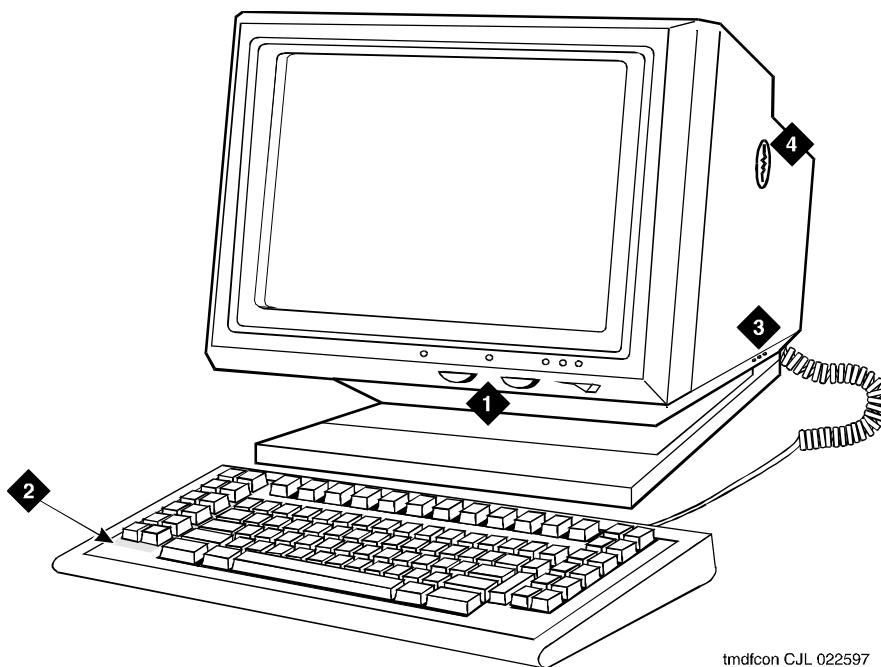

tmdfcon CJL 022597

Figure Notes

- |                                |                     |
|--------------------------------|---------------------|
| 1. Constellation data terminal | 3. Monitor          |
| 2. Keyboard                    | 4. Security keylock |

Figure 6-43. Constellation data terminal

## MDC9000 and MDW9000 cordless voice terminals

---

### Form instructions

---

To administer a MDC9000 or MDW9000 cordless voice terminal, complete the standard as well as the following unique Station form fields.

### Page 1 of the form

|                 |                                  |             |
|-----------------|----------------------------------|-------------|
|                 |                                  | Page 1 of X |
| STATION         |                                  |             |
| Extension: 1003 | Lock Messages? n                 | BCC: 0      |
| Type: MDC9000   | Security Code: _____             | TN: 1_      |
| Port: _____     | Coverage Path 1: _____           | COR: 1_     |
| Name: _____     | Coverage Path 2: _____           | COS: 1_     |
|                 | Hunt-to Station: _____           |             |
| STATION OPTIONS |                                  |             |
|                 | Personalized Ringing Pattern: 1_ |             |
|                 | Message Lamp Ext: 1000           |             |
|                 | MM Complex Data Ext: _____       |             |

### Screen 6-104. MDC9000 and MDW9000 Station form (Page 1 of X)

- **Type** — Enter **MDC9000** or **MDW9000**, as appropriate.

Page 2 of the form

```

                                     STATION
                                     Page 2 of X

FEATURE OPTIONS
    LWC Reception? msa-spe           Auto Select Any Idle Appearance? n
    LWC Activation? y                 Coverage Msg Retrieval? y
    CDR Privacy? n                    Auto Answer: none
    Redirect Notification? y           Data Restriction? n
    Per Button Ring Control? n         Idle Appearance Preference? n
    Bridged Call Alerting? n
    Active Station Ringing: single__   Restrict Last Appearance? y

    H.320 Conversion? n
    AUDIX Name: _____             Multimedia Early Answer? n
    Messaging Server Name: _____   Audible Message Waiting? n

                                     Select Last Used Appearance? n
  
```

Screen 6-105. MDC9000 and MDW9000 Station form (Page 2 of X)

Page 3 of the form

```

                                     STATION
                                     Page 3 of X

SITE DATA
    Room: _____                 Headset? n
    Jack: _____                  Speaker? n
    Cable: _____                 Mounting: d
    Floor: _____                 Cord Length: 0_
    Building: _____              Set Color: _____

ABBREVIATED DIALING
    List1: _____                List2: _____                List3: _____

BUTTON ASSIGNMENTS
    1: call-appr_                    4: call-appr
    2: call-appr_                    5: _____
    3: call-appr_                    6: drop
  
```

Screen 6-106. MDC9000 and MDW9000 Station form (Page 3 of X)

■ **BUTTON ASSIGNMENTS**

The feature buttons that you can assign to the MDC9000 and MDW9000 cordless voice terminals are listed below. The first 3 button assignments can only be assigned as call appearances.



|            |            |            |            |
|------------|------------|------------|------------|
| abr-prog   | abr-spchar | abrdg-appr | abrv-dial  |
| abrv-ring  | ac-alarm   | aca-halt   | after-call |
| alrt-agchg | alt-frl    | assist     | asvn-halt  |
| atd-qcalls | atd-qtime  | aut-msg-wt | auto-cback |
| auto-icom  | auto-in    | autodial   | aux-work   |
| brdg-appr  | busy-ind   | call-appr  | call-fwd   |
| call-park  | call-pkup  | cas-backup | cdr1-alm   |
| cdr2-alm   | cfwd-bsyda | consult    | cov-cback  |
| data-ext   | dial-icom  | dir-pkup   | dn-dst     |
| ds1-alarm  | exclusion  | flash      | goto-cover |
| hunt-ns    | in-call-id | int-aut-an | last-numb  |
| link-alarm | lsvn-halt  | lwc-cancel | lwc-store  |
| major-alm  | man-msg-wt | manual-in  | mct-act    |
| mct-contr  | mj/mn-alm  | night-serv | noans-alrt |
| per-COline | pms-alarm  | pr-awu-alm | pr-pms-alm |
| pr-sys-alm | print-msgs | priority   | q-calls    |
| q-time     | release    | ringer-off | rs-alert   |
| rsvn-halt  | send-calls | send-term  | serv-obsrv |
| signal     | ssvn-halt  | stroke-cnt | term-x-gr  |
| trk-ac-alm | trunk-ns   | verify     | voa-repeat |
| work-code  |            |            |            |

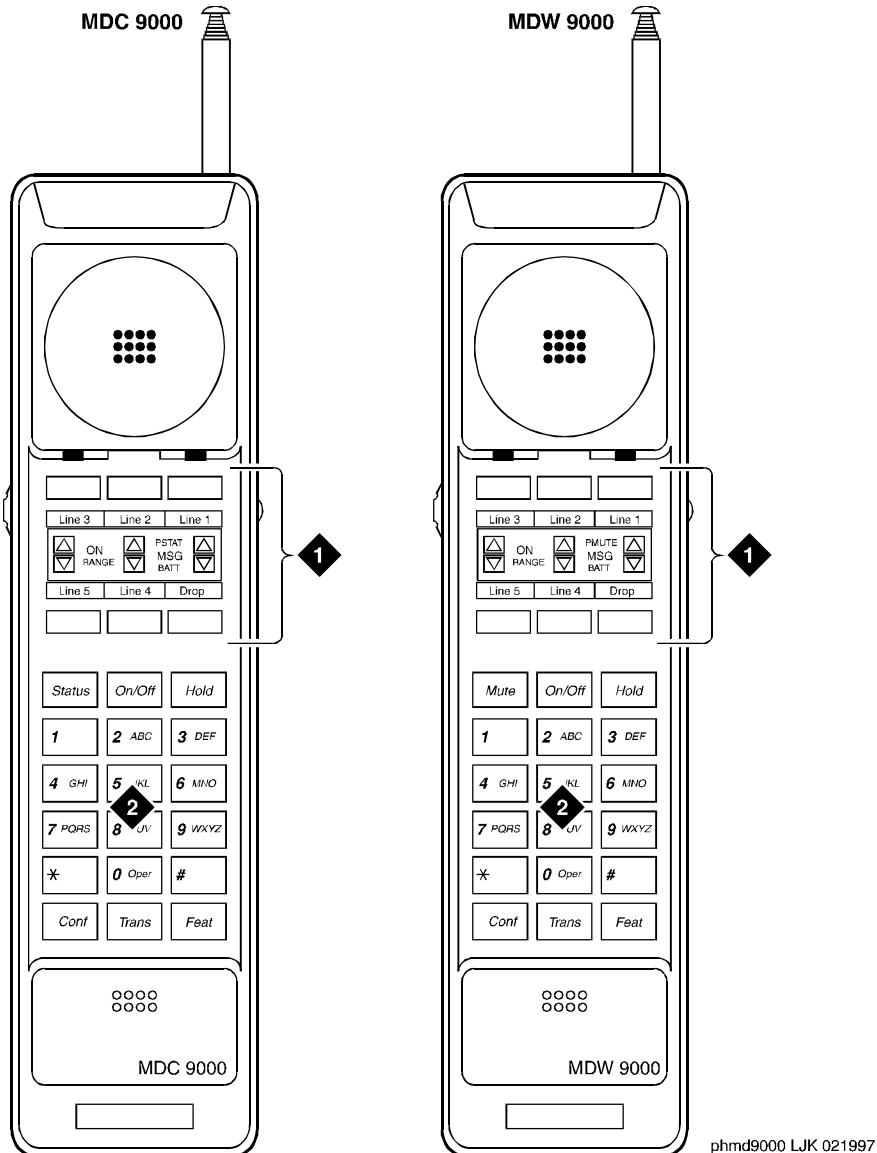

Figure Notes

- 1. 6 programmable buttons
- 2. Dial pad

- 1. 6 programmable buttons
- 2. Dial pad

Figure 6-44. MDC9000 and MDW9000 cordless voice terminals

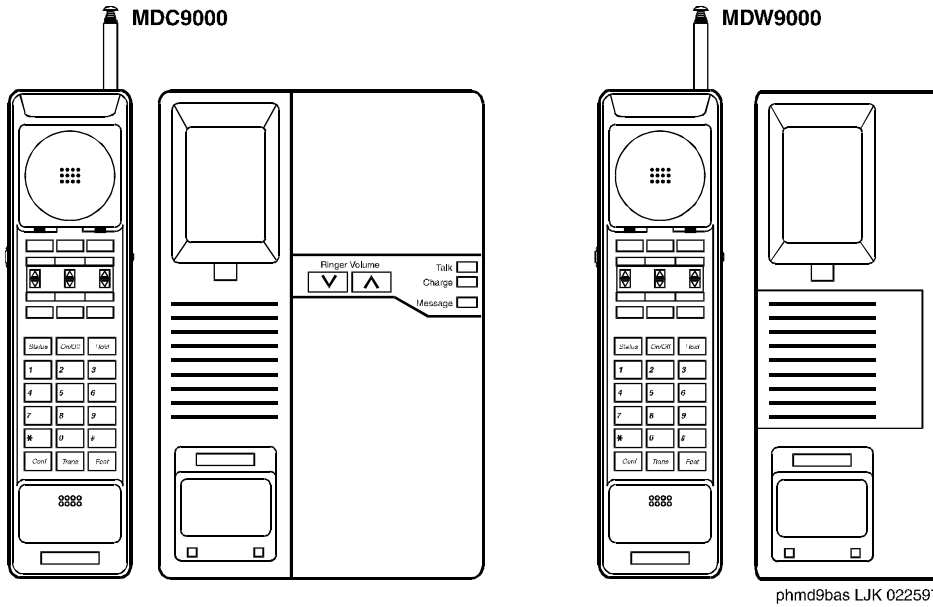

Figure 6-45. MDC9000 and MDW9000 cordless voice terminals and their bases

## CP9530 cordless voice terminals

### Form instructions

To administer a CP9530 cordless voice terminal, complete the standard as well as the following unique Station form fields.

### Page 1 of the form

|                        |                                 |             |
|------------------------|---------------------------------|-------------|
| STATION                |                                 | Page 1 of 3 |
| Extension: _____       | Lock Messages? n                | BCC: 0      |
| Type: CP9530           | Security Code: _____            | TN: 1       |
| Port: _____            | Coverage Path 1: ____           | COR: 1      |
| Name: _____            | Coverage Path 2: ____           | COS: 1      |
|                        | Hunt-to Station: ____           | Tests? y    |
| STATION OPTIONS        |                                 |             |
| Off Premise Station? y | Message Waiting Indicator: ____ |             |
| R Balance Network? n   |                                 |             |

### Screen 6-107. CP9530 Station form (Page 1 of 3)

- **Type** — Enter **CP9530** as appropriate.
- **Tests** — Enter **y** to enable port maintenance tests. Enter **n** when the voice terminal is connected through a peripheral unit, such as a dictating machine, that causes the tests to fail. Default is **y**.

Page 2 of 3

STATION

FEATURE OPTIONS

|                              |                                 |
|------------------------------|---------------------------------|
| LWC Reception? msa-spe       | Coverage Msg Retrieval? y       |
| LWC Activation? y            | Auto Answer: none               |
| CDR Privacy? y               | Data Restriction? n             |
| Redirect Notification? y     | Call Waiting Indication? y      |
| Per Button Ring Control? n   | Att. Call Waiting Indication? y |
| Bridged Call Alerting? n     | Distinctive Audible Alert? y    |
| Switchhook Flash? y          | Adjunct Supervision? n          |
| Ignore Rotary Digits? _      |                                 |
| H.320 Conversion? n          |                                 |
| AUDIX Name: _____            | Multimedia Early Answer? n      |
| Messaging Server Name: _____ | Audible Message Waiting? n      |

Screen 6-108. CP9530 Station form (Page 2 of 3)

Page 3 of 3

STATION

SITE DATA

|                 |                  |
|-----------------|------------------|
| Room: _____     | Headset? n       |
| Jack: ____      | Speaker? n       |
| Cable: ____     | Mounting: d      |
| Floor: _____    | Cord Length: 0_  |
| Building: _____ | Set Color? _____ |

ABBREVIATED DIALING

|              |              |              |
|--------------|--------------|--------------|
| List1: _____ | List2: _____ | List3: _____ |
|--------------|--------------|--------------|

HOT LINE DESTINATION

|   |                 |
|---|-----------------|
| Abbreviated Dialing List Number (From above 1, 2 or 3): _ | Dial Code: ____ |
| Line Appearance: call-appr_                               |                 |

Screen 6-109. CP9530 Station form (Page 3 of 3)

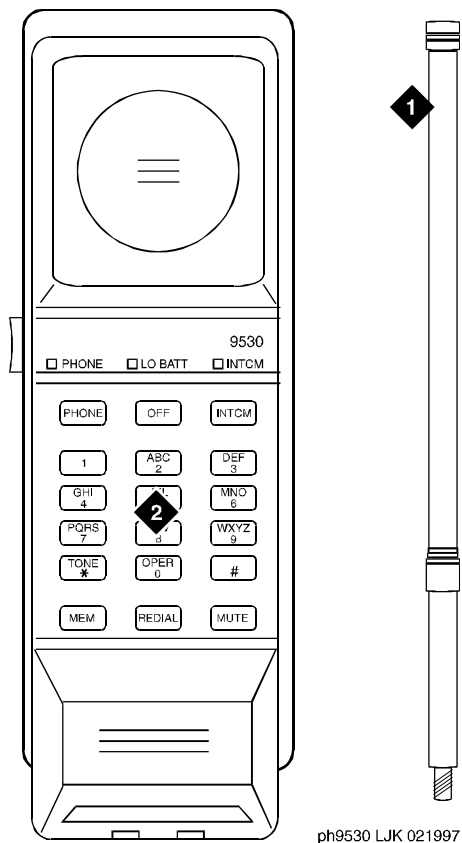
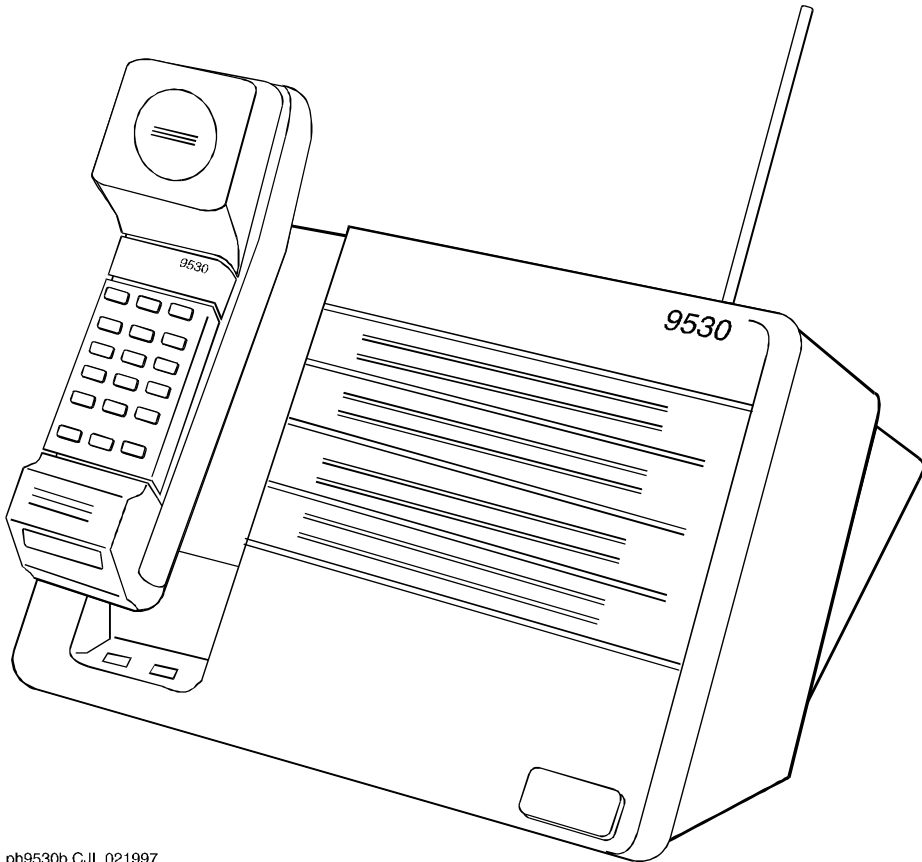

Figure Notes

1. Antenna

2. Dial pad

Figure 6-46. CP9530 cordless voice terminal



---

**Figure 6-47.** CP9530 cordless voice terminal and base

## 8403B, 8405B, 8405B+ and 8410B voice terminals

### Form instructions

To administer a 8403B, 8405B, 8405+, or 8410B voice terminal, complete the standard as well as the following unique Station form fields. For information about adjusting the system-level parameters and audio levels for the 8400-series voice terminals, see [“Terminal Parameters form” on page 6-9](#).

### Page 1 of the form

Page 1 of X

STATION

|                 |                        |         |
|-----------------|------------------------|---------|
| Extension: 1003 | Lock Messages? n       | BCC: 0  |
| Type: 8403B__   | Security Code: _____   | TN: 1_  |
| Port: _____     | Coverage Path 1: _____ | COR: 1_ |
| Name: _____     | Coverage Path 2: _____ | COS: 1_ |
|                 | Hunt-to Station: _____ |         |

STATION OPTIONS

|                     |                                 |
|---------------------|---------------------------------|
| Data Module? n      | Personalized Ringing Pattern: 1 |
| Speakerphone: 1-way | Message Lamp Ext: 1000          |
|                     | Mute Button Enabled? y          |
|                     | MM Complex Data Ext: _____      |

### Screen 6-110. 8403B, 8405B, 8405B+, and 8410B Station form (Page 1 of X)

- **Type** — Enter one of the following:
  - **8403B** (supports 1-way speakerphone) — default
  - **8405B** (supports 1-way speakerphone)
  - **8405B+** (supports 2-way speakerphone)
  - **8410B** (supports 2-way speakerphone)
- **Data Module** — Enter **y** if this terminal is to connect to a data terminal via a 7400B or 8400B data module. If you enter **y**, you must complete the Data Module form. Default is **n**.



### Page 2 of the form

Page 2 of X

| FEATURE OPTIONS                | STATION                            |
|--------------------------------|------------------------------------|
| LWC Reception? msa-spe         | Auto Select Any Idle Appearance? n |
| LWC Activation? y              | Coverage Msg Retrieval? y          |
| CDR Privacy? n                 | Auto Answer: none                  |
| Redirect Notification? y       | Data Restriction? n                |
| Per Button Ring Control? n     | Idle Appearance Preference? n      |
| Bridged Call Alerting? n       | Restrict Last Appearance? y        |
| Active Station Ringing: single |                                    |
| H.320 Conversion? n            | Multimedia Early Answer? n         |
| AUDIX Name: _____              | Audible Message Waiting? y         |
| Messaging Server Name: _____   | Select Last Used Appearance? n     |

Screen 6-111. 8403B, 8405B, 8405B+, and 8410B Station form (Page 2 of X)

### Page 3 of the 8405 and 8410 form

Page 3 of X

| SITE DATA           | STATION          |
|---------------------|------------------|
| Room: _____         | Headset? n       |
| Jack: _____         | Speaker? n       |
| Cable: _____        | Mounting: d      |
| Floor: _____        | Cord Length: 0   |
| Building: _____     | Set Color: _____ |
| ABBREVIATED DIALING |                  |
| List1: _____        | List2: _____     |
|                     | List3: _____     |
| BUTTON ASSIGNMENTS  |                  |
| 1: call-appr_       |                  |
| 2: call-appr_       |                  |
| 3: call-appr_       |                  |

Screen 6-112. 8403B Station form (Page 3 of X)

Page 3 of X

SITE DATA

|                 |                  |
|-----------------|------------------|
| Room: _____     | Headset? n       |
| Jack: _____     | Speaker? n       |
| Cable: _____    | Mounting: d      |
| Floor: _____    | Cord Length: 0   |
| Building: _____ | Set Color: _____ |

ABBREVIATED DIALING

|              |              |              |
|--------------|--------------|--------------|
| List1: _____ | List2: _____ | List3: _____ |
|--------------|--------------|--------------|

BUTTON ASSIGNMENTS

|               |           |
|---------------|-----------|
| 1: call-appr_ | 6: _____  |
| 2: call-appr_ | 7: _____  |
| 3: call-appr_ | 8: _____  |
| 4: _____      | 9: _____  |
| 5: _____      | 10: _____ |

Screen 6-113. 8405B, 8405B+, and 8410B Station form (Page 3 of X)

■ **BUTTON ASSIGNMENTS**

The feature buttons that you can assign are listed below. The first 3 buttons on the 8403B and the first 3 buttons on the 8405B, 8505B+, and 8410B voice terminals default as call appearance buttons. The 8405B and the 8405B+ voice terminals have only 5 call appearance buttons. You can readminister call appearance buttons.

|                        |            |                         |            |
|------------------------|------------|-------------------------|------------|
| abr-prog               | abr-spchar | abrdg-appr <sup>1</sup> | abrv-dial  |
| abrv-ring              | ac-alarm   | aca-halt                | after-call |
| alrt-agchg             | alt-frl    | assist                  | asvn-halt  |
| atd-qcalls             | atd-qtime  | aut-msg-wt              | auto-cback |
| auto-icom              | auto-in    | autodial                | aux-work   |
| brdg-appr <sup>1</sup> | busy-ind   | call-appr               | call-fwd   |
| call-park              | call-pkup  | cas-backup              | cdr1-alm   |
| cdr2-alm               | cfwd-bsyda | consult                 | cov-cback  |
| data-ext               | dial-icom  | dir-pkup                | dn-dst     |
| ds1-alarm              | exclusion  | flash                   | goto-cover |
| hunt-ns                | in-call-id | int-aut-an              | last-numb  |
| link-alarm             | lsvn-halt  | lwc-cancel              | lwc-store  |
| major-alm              | man-msg-wt | manual-in               | mct-act    |
| mct-contr              | mf-da-intl | mf-op-intl              | mj/mn-alm  |
| night-serv             | noans-alrt | per-COline              | pms-alarm  |
| pr-awu-alm             | pr-pms-alm | pr-sys-alm              | print-msgs |
| priority               | q-calls    | q-time                  | release    |
| ringer-off             | rs-alert   | rsvn-halt               | send-calls |
| send-term              | serv-obsrv | signal                  | ssvn-halt  |
| stroke-cnt             | term-x-gr  | trk-ac-alm              | trunk-ns   |
| verify                 | voa-repeat | work-code               |            |

---

1. Not allowed for 8403B

## Page 3 of the 8403B form

### ■ FEATURE BUTTON ASSIGNMENTS

On the form for the 8403B voice terminal, these fields correspond to the 12 feature buttons accessed from the 8403B voice terminal by first pressing the feature button and then pressing a number on the dial pad. You cannot administer these buttons as a bridged appearance (brdg-appr or abrdg-appr).

**Page 4 of the form**

Page 4 of X

| FEATURE BUTTON ASSIGNMENTS | STATION |
|----------------------------|---------|
| 1: _____                   |         |
| 2: _____                   |         |
| 3: _____                   |         |
| 4: _____                   |         |
| 5: _____                   |         |
| 6: _____                   |         |
| 7: _____                   |         |
| 8: _____                   |         |
| 9: _____                   |         |
| *: _____                   |         |
| 0: _____                   |         |
| #: _____                   |         |

**Screen 6-114. 8403B Station form (Page 4 of X)**

■ **FEATURE BUTTON ASSIGNMENTS**

The features and functions that you can assign to the terminal's administrable buttons are the same as those for BUTTON ASSIGNMENTS above.

Page X of Y of the form (DATA MODULE)

Page X of Y

STATION

DATA MODULE

Data Extension: \_\_\_\_\_ Name: \_\_\_\_\_ BCC: 2  
COS: 1\_  
COR: 1\_  
ITC: restricted\_\_ TN: 1\_

ABBREVIATED DIALING  
List1: \_\_\_\_\_

SPECIAL DIALING OPTION: hot-line  
HOT LINE DESTINATION  
DEFAULT DIALING  
Abbreviated Dialing Dial Code (From above list): \_\_\_\_

ASSIGNED MEMBER (Station with a data extension button for this data module)

| Ext      | Name  |
|----------|-------|
| 1. _____ | _____ |

Screen 6-115. 8403B, 8405B, 8405B+, 8410B, and 8434B Data Module form (Page X of Y)

This page displays only if Data Module is y.

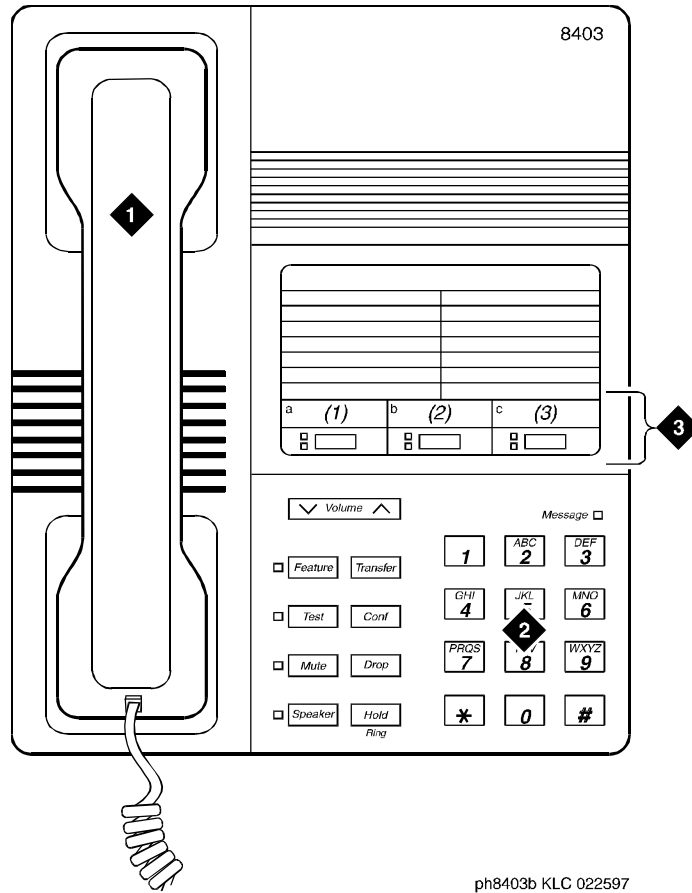

ph8403b KLC 022597

Figure Notes

- 1. Handset
- 2. Dial pad

- 3. 3 programmable buttons

Figure 6-48. 8403B voice terminal

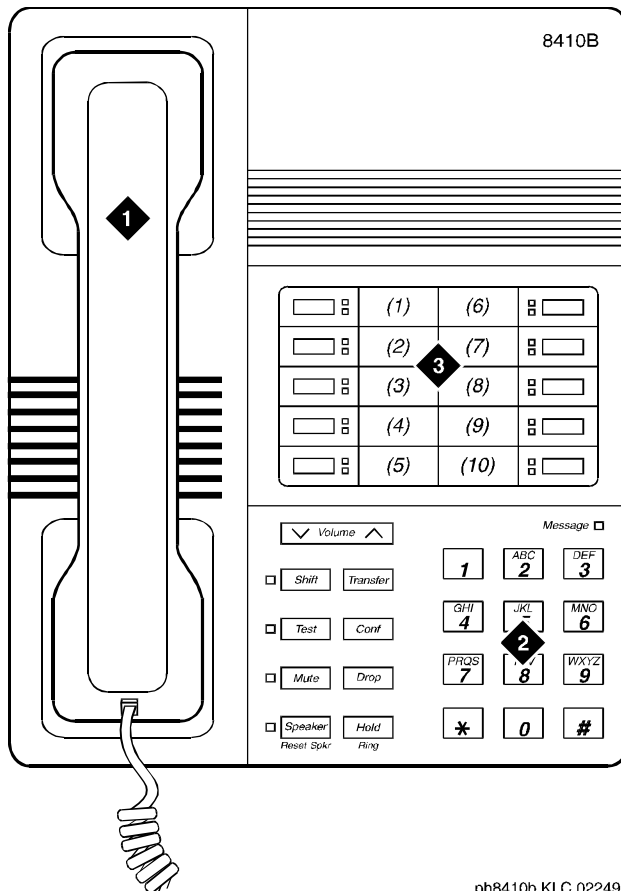

ph8410b KLC 022497

Figure Notes

- 1. Handset
- 2. Dial pad

- 3. 10 programmable buttons

Figure 6-49. 8410B voice terminal

NOTE:

The 8405B and 8405B+ look like the 8410B with the exception that the 8405 series do not have the second column of line appearances.

## 8405D, 8405D+, 8410D, and 8434D voice terminals

### Form instructions

To administer a 8405D, 8405+, 8410D, or 8434D voice terminal, complete the standard as well as the following unique Station form fields. For information about adjusting the system-level parameters and audio levels for the 8400-series voice terminals, see [“Terminal Parameters form” on page 6-9](#).

### Page 1 of the form

|                           |                                 |             |
|---------------------------|---------------------------------|-------------|
|                           |                                 | Page 1 of X |
| STATION                   |                                 |             |
| Extension: 1003           | Lock Messages? n                | BCC: 0      |
| Type: 8434D__             | Security Code: _____            | TN: 1_      |
| Port: _____               | Coverage Path 1: _____          | COR: 1_     |
| Name: _____               | Coverage Path 2: _____          | COS: 1_     |
|                           | Hunt-to Station: _____          |             |
| STATION OPTIONS           |                                 |             |
| Data Module? n            | Personalized Ringing Pattern: 1 |             |
| Speakerphone: 2-way       | Message Lamp Ext: 1000          |             |
| Display Language: english | Mute Button Enabled? y          |             |
|                           | Expansion Module? n             |             |
|                           | MM Complex Data Ext: n          |             |

Screen 6-116. 8405D, 8405D+, 8410D, and 8434D Station form (Page 1 of X)

- **Type** — Enter one of the following:
  - **8405D** (supports 1-way speakerphone) — default
  - **8405D+** (supports 2-way speakerphone)
  - **8410D** (supports 2-way speakerphone)
  - **8434D** (supports 2-way speakerphone)



## Page 2 of the form

| FEATURE OPTIONS          |         | STATION                          |      |
|--------------------------|---------|----------------------------------|------|
| LWC Reception?           | msa-spe | Auto Select Any Idle Appearance? | n    |
| LWC Activation?          | y       | Coverage Msg Retrieval?          | y    |
| CDR Privacy?             | n       | Auto Answer:                     | none |
| Redirect Notification?   | y       | Data Restriction?                | n    |
| Per Button Ring Control? | n       | Idle Appearance Preference?      | n    |
| Bridged Call Alerting?   | n       |                                  |      |
| Active Station Ringing:  | single  | Restrict Last Appearance?        | y    |
| H.320 Conversion?        | n       |                                  |      |
| AUDIX Name:              | _____   | Multimedia Early Answer?         | n    |
| Messaging Server Name:   | _____   | Audible Message Waiting?         | y    |
|                          |         | Display Client Redirection?      | n    |
|                          |         | Select Last Used Appearance?     | n    |

### Screen 6-117. 8405D, 8405D+, 8410D, and 8434D Station form (Page 2 of X)

- **Data Module** — Enter **y** if this terminal is connected to an optional 7400B or 8400B data module. If you enter **y**, you must complete the Data Module form. Default is **n**.
- **Expansion Module** — (8434D only) Identifies whether a ZE801A expansion module is attached to the station terminal. Enter **y** or **n** (default). If you enter **y**, an optional page of the form appears to allow you to administer the Expansion Module buttons.

Page 3 of the form

Page 3 of X

STATION

|                 |  |                                      |
|-----------------|--|--------------------------------------|
| SITE DATA       |  |                                      |
| Room: _____     |  | Headset? <input type="checkbox"/> n  |
| Jack: _____     |  | Speaker? <input type="checkbox"/> n  |
| Cable: _____    |  | Mounting: <input type="checkbox"/> d |
| Floor: _____    |  | Cord Length: <input type="text"/> 0  |
| Building: _____ |  | Set Color: _____                     |

|                     |              |              |              |
|---------------------|--------------|--------------|--------------|
| ABBREVIATED DIALING | List1: _____ | List2: _____ | List3: _____ |
|---------------------|--------------|--------------|--------------|

|                     |           |
|---------------------|-----------|
| BUTTON ASSIGNMENTS  |           |
| 1: <u>call-appr</u> | 6: _____  |
| 2: <u>call-appr</u> | 7: _____  |
| 3: <u>call-appr</u> | 8: _____  |
| 4: _____            | 9: _____  |
| 5: _____            | 10: _____ |

Screen 6-118. 8405D, 8405D+, 8410D, and 8434D Station form (Page 3 of X)

■ **BUTTON ASSIGNMENTS**

The feature buttons that you can assign to the these voice terminals are listed below.

**Table 6-7. Button Assignments for Page 3 of the Form**

|                         |                        |                         |                         |
|-------------------------|------------------------|-------------------------|-------------------------|
| abr-prog                | abr-spchar             | abrdg-appr              | abrv-dial               |
| abrv-ring               | ac-alarm               | aca-halt                | after-call              |
| alrt-agchg              | alt-frl                | assist                  | asvn-halt               |
| atd-qcalls <sup>1</sup> | atd-qtime <sup>1</sup> | aut-msg-wt              | auto-cback              |
| auto-icom               | auto-in                | auto-wkup <sup>1</sup>  | autodial                |
| aux-work                | brdg-appr              | busy-ind                | call-appr               |
| call-disp <sup>1</sup>  | call-fwd               | call-park               | call-pkup               |
| callr-info <sup>1</sup> | cas-backup             | cdr1-alm                | cdr2-alm                |
| cfwd-bsyda              | check-in <sup>1</sup>  | check-out <sup>1</sup>  | clk-overid <sup>1</sup> |
| consult                 | cov-cback              | cov-msg-rt <sup>1</sup> | data-ext                |

*Continued on next page*

**Table 6-7. Button Assignments for Page 3 of the Form — Continued**

|                        |                         |                         |                         |
|------------------------|-------------------------|-------------------------|-------------------------|
| date-time <sup>1</sup> | delete-msg <sup>1</sup> | dial-icom               | directory <sup>1</sup>  |
| dir-pkup               | disp-chrg               | disp-norm               | dn-dst                  |
| ds1-alarm              | exclusion               | ext-dn-dst <sup>1</sup> | flash                   |
| goto-cover             | grp-dn-dst <sup>1</sup> | hunt-ns                 | in-call-id              |
| inspect <sup>1</sup>   | int-aut-an              | last-numb               | link-alarm              |
| lsvn-halt              | lwc-cancel              | lwc-lock                | lwc-store               |
| major-alm              | man-msg-wt              | man-overid <sup>1</sup> | manual-in               |
| mct-act                | mct-contr               | mf-da-intl              | mf-op-intl              |
| mj/mn-alm              | msg-retr <sup>1</sup>   | mwn-act <sup>1</sup>    | mwn-deact <sup>1</sup>  |
| next <sup>1</sup>      | night-serv              | noans-ahrt              | normal <sup>2</sup>     |
| per-COline             | pms-alarm               | pr-awu-alm              | pr-pms-alm              |
| pr-sys-alm             | print-msgs              | priority                | q-calls                 |
| q-time                 | release                 | ringer-off              | rs-alert                |
| rsvn-halt              | scroll                  | send-calls              | send-term               |
| serv-obsrv             | signal                  | ssvn-halt               | stored-num <sup>1</sup> |
| stroke-cnt             | term-x-gr               | timer <sup>1</sup>      | trk-ac-alm              |
| trk-id                 | trunk-name <sup>1</sup> | trunk-ns                | verify                  |
| voa-repeat             | vu-display              | work-code               |                         |

*Continued on next page*

1. Display-type button
2. All of these voice terminals have an Exit button. This button is mapped to the normal button function. Therefore, you are not allowed to specify a normal feature button on any of the button fields on these forms.

## Page 4 of the 8434D form

Page 4 of X

STATION

FEATURE BUTTON ASSIGNMENTS

|           |           |
|-----------|-----------|
| 1: _____  | 13: _____ |
| 2: _____  | 14: _____ |
| 3: _____  | 15: _____ |
| 4: _____  | 16: _____ |
| 5: _____  | 17: _____ |
| 6: _____  | 18: _____ |
| 7: _____  | 19: _____ |
| 8: _____  | 20: _____ |
| 9: _____  | 21: _____ |
| 10: _____ | 22: _____ |
| 11: _____ | 23: _____ |
| 12: _____ | 24: _____ |

Screen 6-119. 8434D Station form (Page 4 of X)

### ■ FEATURE BUTTON ASSIGNMENTS

The 24 feature buttons correspond to the fixed, dual-LED buttons on the right side of the 8434D voice terminal. The features that you can assign to buttons are the same as those listed for BUTTON ASSIGNMENTS above.

Page 4 of the 8405D, 8405D+, and 8410D forms  
Page 5 of the 8434 form

Page 4 of X

STATION

SOFTKEY BUTTON ASSIGNMENTS

|     |            |           |
|-----|------------|-----------|
| 1:  | lwc-store_ |           |
| 2:  | lwc-cancel |           |
| 3:  | auto-cback |           |
| 4:  | timer_____ |           |
| 5:  | call-fwd__ | Ext: ____ |
| 6:  | call-park_ |           |
| 7:  | date-time_ |           |
| 8:  | priority__ |           |
| 9:  | abr-prog__ |           |
| 10: | abr-spchar | Char: ~p  |
| 11: | abr-spchar | Char: ~m  |
| 12: | abr-spchar | Char: ~w  |

Screen 6-120. 8405D, 8405D+, and 8410D Station form (Page 4 of X)

Page 5 of X

STATION

SOFTKEY BUTTON ASSIGNMENTS

|     |             |           |
|-----|-------------|-----------|
| 1:  | lwc-store_  |           |
| 2:  | lwc-cancel  |           |
| 3:  | consult____ |           |
| 4:  | auto-cback  |           |
| 5:  | timer_____  |           |
| 6:  | call-fwd__  | Ext: ____ |
| 7:  | call-park_  |           |
| 8:  | exclusion__ |           |
| 9:  | date-time_  |           |
| 10: | priority__  |           |
| 11: | abr-prog__  |           |
| 12: | abr-spchar  | Char: ~p  |
| 13: | abr-spchar  | Char: ~s  |
| 14: | abr-spchar  | Char: ~m  |
| 15: | abr-spchar  | Char: ~w  |

Screen 6-121. 8434D Station form (Page 5 of X)

■ **SOFTKEY BUTTON ASSIGNMENTS**

The 8405D, 8405D+, and 8410D voice terminals support 12 display softkeys and the 8434D voice terminal supports 15 softkeys. You can assign features to these softkeys, making them “virtual” buttons. When you assign a feature to a softkey, the system automatically downloads to the terminal the appropriate information for operating the feature.

You may also customize the softkey displays, for English, French, Italian, or Spanish. To customize the labels, use the Language Translation form by issuing the command “change display-messages softkey-labels”. You may enter a five-character label for each of the softkeys.

Pages 6 or 7 of the 8434D form (EXPANSION MODULE) appear only if Expansion Module is set to **y**. Use these pages to administer buttons on the ZE801A Expansion Module if one is attached to the 8434D terminal. Fields 1–9 on the form correspond to the 18 dual-LED feature buttons on the Expansion Module; buttons 10–12 correspond to the 6 single-LED feature buttons. You can assign to these buttons any of the features or functions that you can assign to the feature buttons on the 8434D terminal from the previous list.

**Page X of Y of the form (DATA MODULE)**

Page X of Y

STATION

DATA MODULE

Data Extension: \_\_\_\_\_ Name: \_\_\_\_\_ BCC: 2  
 COS: 1\_  
 COR: 1\_  
 ITC: restricted TN: 1\_

ABBREVIATED DIALING  
 List1: \_\_\_\_\_

SPECIAL DIALING OPTION: hot-line  
 HOT LINE DESTINATION  
 DEFAULT DIALING  
 Abbreviated Dialing Dial Code (From above list): \_\_\_\_

ASSIGNED MEMBER (Station with a data extension button for this data module)

| Ext      | Name  |
|----------|-------|
| 1. _____ | _____ |

**Screen 6-122. 8405D, 8505D+, 8410D, and 8434D Data Module form (Page X of Y)**

This page displays only if Data Module is **y**.

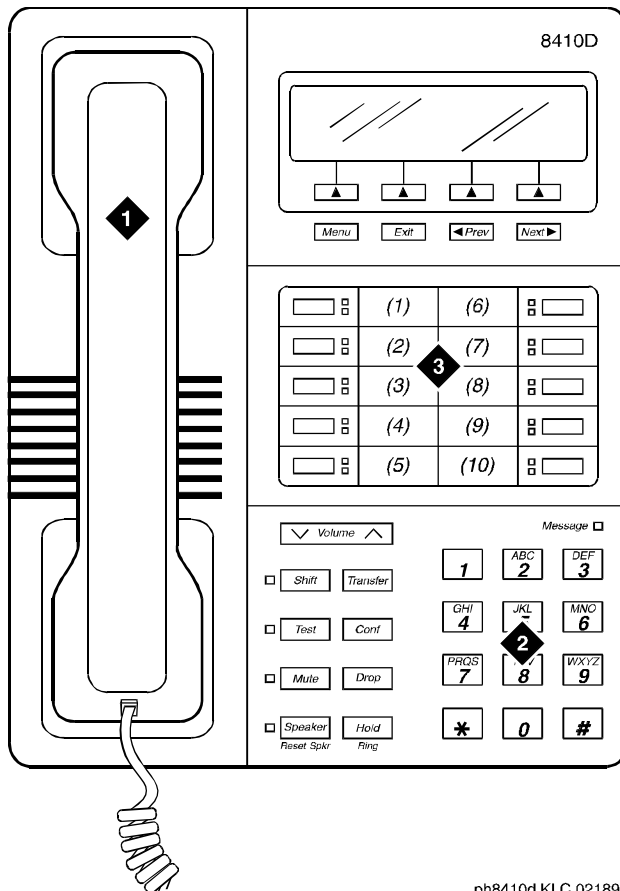

ph8410d KLC 021897

Figure 6-49 Notes

- 1. Handset
- 2. Dial pad
- 3. 10 programmable buttons

Figure 6-50. 8410D voice terminal

**NOTE:**

The 8405D and 8405D+ look like the 8410D with the exception that the 8405 series do not have the second column of line appearances.

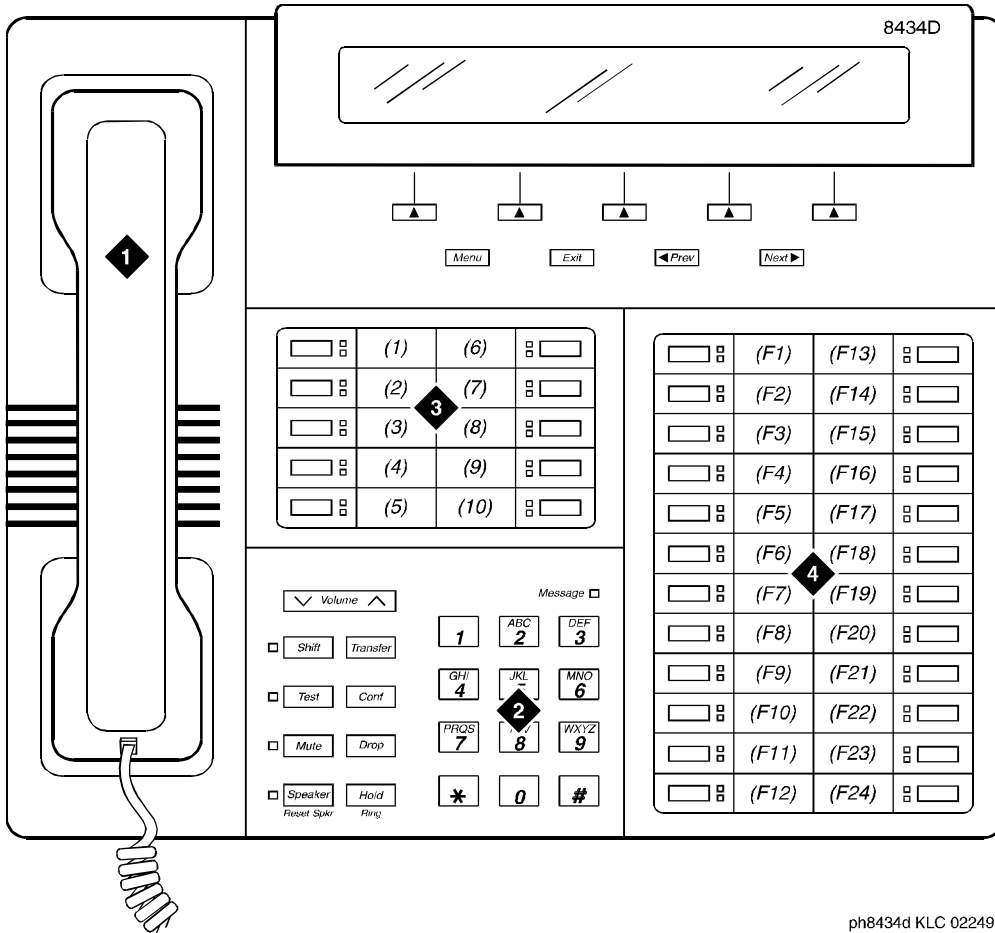

ph8434d KLC 022497

Figure 6-50 Notes

- 1. Handset
- 2. Dial pad
- 3. 10 programmable buttons
- 4. 24 feature buttons

Figure 6-51. 8434D voice terminal



## 8411B and 8411D voice terminals

### Form instructions

To administer a 8411B or 8411D voice terminal, complete the standard as well as the following unique Station form fields. For information about adjusting the system-level parameters and audio levels for the 8411-series voice terminals, see [“Terminal Parameters form” on page 6-9](#).

### Page 1 of the form

|                           |                                 |             |
|---------------------------|---------------------------------|-------------|
| STATION                   |                                 | Page 1 of X |
| Extension: 1003           | Lock Messages? n                | BCC: 0      |
| Type: 8411D__             | Security Code: _____            | TN: 1_      |
| Port: _____               | Coverage Path 1: _____          | COR: 1_     |
| Name: _____               | Coverage Path 2: _____          | COS: 1_     |
|                           | Hunt-to Station: _____          |             |
| STATION OPTIONS           |                                 |             |
| Data Option: analog       | Personalized Ringing Pattern: 1 |             |
| Speakerphone: 2-way       | Message Lamp Ext: 1000          |             |
| Display Language: english | Mute Button Enabled? y          |             |
| PassageWay? n             | MM Complex Data Ext: _____      |             |

Screen 6-123. 8411B and 8411D Station form (Page 1 of X)

- **Type** — Enter **8411B** or **8411D** as appropriate.
- **Data Option** — If you are using the administered analog adjunct, enter analog and complete the Analog Adjunct form. If you are using a 7400B or 8400B data module, enter data-module and complete the Data Module form.

When an endpoint changes its terminal from a non-8411 terminal to a 8411B/D terminal, the options in the station forms remain the same except for the Data Option, Data Module and PassageWay.

- **PassageWay** — Enter **y** if you are using PassageWay.



**CAUTION:**

*Do not enable PassageWay unless the user of the PC at this extension has a valid licensed copy of PassageWay Direct Connection to DEFINITY ECS running on the PC.*

## Page 2 of the form

```

                                                                 Page 2 of X
                                STATION
FEATURE OPTIONS
    LWC Reception? msa-spe          Auto Select Any Idle Appearance? n
    LWC Activation? y                Coverage Msg Retrieval? y
    CDR Privacy? n                  Auto Answer: none
    Redirect Notification? y         Data Restriction? n
    Per Button Ring Control? n      Idle Appearance Preference? n
    Bridged Call Alerting? n
    Active Station Ringing: single   Restrict Last Appearance? y

    H.320 Conversion? n
    AUDIX Name: _____          Multimedia Early Answer? n
    Messaging Server Name: _____ Audible Message Waiting? n
                                        Display Client Redirection? n
                                        Select Last Used Appearance? n
```

## Screen 6-124. 8411B and 8411D Station form (Page 2 of X)

## Page 3 of the form

```

                                                                 Page 3 of X
                                STATION
SITE DATA
    Room: _____                Headset? n
    Jack: _____                 Speaker? n
    Cable: _____                Mounting: d
    Floor: _____                Cord Length: 0_
    Building: _____              Set Color: _____

ABBREVIATED DIALING
    List1: _____                List2: _____                List3: _____

BUTTON ASSIGNMENTS
    1: call-appr_                   6: _____
    2: call-appr_                   7: _____
    3: call-appr_                   8: _____
    4: _____                     9: _____
    5: _____                    10: _____
```

## Screen 6-125. 8411B and 8411D Station form (Page 3 of X)

### ■ BUTTON ASSIGNMENTS

The feature buttons that you can assign to the these voice terminals are listed below.

|                         |                         |                         |                         |
|-------------------------|-------------------------|-------------------------|-------------------------|
| abr-prog                | abr-spchar              | abrdg-appr              | abrv-dial               |
| abrv-ring               | ac-alarm                | aca-halt                | after-call              |
| alrt-agchg              | alt-frl                 | assist                  | asvn-halt               |
| atd-qcalls <sup>1</sup> | atd-qtime <sup>1</sup>  | aut-msg-wt              | auto-cback              |
| auto-icom               | auto-in                 | auto-wkup <sup>1</sup>  | autodial                |
| aux-work                | brdg-appr               | busy-ind                | call-appr               |
| call-disp <sup>1</sup>  | call-fwd                | call-park               | call-pkup               |
| callr-info <sup>1</sup> | cas-backup              | cdr1-alm                | cdr2-alm                |
| cfwd-bsyda              | check-in <sup>1</sup>   | check-out <sup>1</sup>  | clk-overid <sup>1</sup> |
| consult                 | cov-cback               | cov-msg-rt <sup>1</sup> | data-ext                |
| date-time <sup>1</sup>  | delete-msg <sup>1</sup> | dial-icom               | directory <sup>1</sup>  |
| dir-pkup                | disp-chrg               | disp-norm               | dn-dst                  |
| ds1-alarm               | exclusion               | ext-dn-dst <sup>1</sup> | flash                   |
| goto-cover              | grp-dn-dst <sup>1</sup> | hunt-ns                 | in-call-id              |
| inspect <sup>1</sup>    | int-aut-an              | last-numb               | link-alarm              |
| lsvn-halt               | lwc-cancel              | lwc-lock                | lwc-store               |
| major-alm               | man-msg-wt              | man-overid <sup>1</sup> | manual-in               |
| mct-act                 | mct-contr               | mf-da-intl              | mf-op-intl              |
| mj/mn-alm               | msg-retr <sup>1</sup>   | mwn-act <sup>1</sup>    | mwn-deact <sup>1</sup>  |
| next <sup>1</sup>       | night-serv              | noans-alrt              | normal                  |
| per-COline              | pms-alarm               | pr-awu-alm              | pr-pms-alm              |
| pr-sys-alm              | print-msgs              | priority                | q-calls                 |
| q-time                  | release                 | ringer-off              | rs-alert                |
| rsvn-halt               | scroll                  | send-calls              | send-term               |
| serv-obsrv              | signal                  | ssvn-halt               | stored-num <sup>1</sup> |
| stroke-cnt              | term-x-gr               | timer <sup>1</sup>      | trk-ac-alm              |
| trk-id                  | trunk-name <sup>1</sup> | trunk-ns                | verify                  |
| voa-repeat              | vu-display              | work-code               |                         |

---

1. Display-type button, not available on 8411B.

## Page 4 of the 8411B and 8411D forms

Page 4 of X

STATION

SOFTKEY BUTTON ASSIGNMENTS

|     |            |            |
|-----|------------|------------|
| 1.  | lwc-store_ |            |
| 2.  | lwc-cancel |            |
| 3.  | auto-cback |            |
| 4.  | timer_____ |            |
| 5.  | call-fwd_  | ext: _____ |
| 6.  | call-park_ |            |
| 7.  | date-time_ |            |
| 8.  | priority__ |            |
| 9.  | abr-prog__ |            |
| 10. | apr-spchar | Char: ~p   |
| 11. | abr-spchar | Char: ~m   |
| 12. | abr-spchar | Char: ~w   |

### Screen 6-126. 8411D Station form (Page 4 of X)

#### ■ SOFTKEY BUTTON ASSIGNMENTS

The 8411B and 8411D voice terminals support 12 display softkeys. You can assign features to these softkeys, making them “virtual” buttons. When you assign a feature to a softkey, the system automatically downloads to the terminal the appropriate information for operating the feature.



#### NOTE:

On the 8411, do not administer buttons 9 and 10 if you set Data Option to **analog** and set PassageWay to **yes**.

### Page X of Y of the form (DATA MODULE)

Page Y of X

DATA MODULE

STATION

Data Extension: \_\_\_\_\_ Name: \_\_\_\_\_ BCC: 2  
COS: 1\_  
COR: 1\_  
ITC: restricted\_ TN: 1\_

ABBREVIATED DIALING  
List1: \_\_\_\_\_

SPECIAL DIALING OPTION: hot-line  
HOT LINE DESTINATION  
Abbreviated Dialing Dial Code (From above list): \_\_\_\_

ASSIGNED MEMBER (Station with a data extension button for this data module)

| Ext | Name |
|-----|------|
| 1.  |      |

### Screen 6-127. 8411B and 8411D Data Module form (Page Y of X)

This page displays only if Data Option is **data-module**.

### Page X of Y of the form (ANALOG ADJUNCT)

Page Y of X

ANALOG ADJUNCT

STATION

Data Extension: \_\_\_\_\_ Name: \_\_\_\_\_  
COS: 1\_  
COR: 1\_  
ITC: restricted\_ TN: 1\_

ABBREVIATED DIALING  
List1: \_\_\_\_\_

SPECIAL DIALING OPTION: \_\_\_\_\_  
HOT LINE DESTINATION  
Abbreviated Dialing Dial Code (From above list): \_\_\_\_

ASSIGNED MEMBER (Station with a data extension button for this analog adjunct)

| Ext | Name |
|-----|------|
| 1.  |      |

### Screen 6-128. 8411B and 8411D Analog Adjunct form (Page Y of X)

This page displays only if Data Option is **analog**. You cannot assign default dialing options with the administered analog adjunct.

## World Class Basic Rate Interface terminal

---

World Class Basic Rate Interface (WCBRI) terminal provides an international BRI platform that offers multiple protocol options to meet specific country and application requirements.

WCBRI supports the following country protocols:

- Bellcore National ISDN-1 protocol in the United States (TR268)
- Australia (AUSTEL TS013 and Telecom Australia TPH 1962)
- Japan (NTT BRI)
- Singapore (FETEX 150 TIF 218)
- ETSI NET 3 protocol (ETS 300 102) for use in most of Europe

WCBRI supports multipoint (up to 2 devices per port) for Bellcore National ISDN-1 Country Protocol.

DEFINITY ECS does not support the following for WCBRI terminals:

- Transfer, hold, drop, or conference
- Administrable feature buttons
- Multiple call appearances and features requiring multiple call appearances

DEFINITY ECS does not control the display information or ring type at a WCBRI terminal.

When DEFINITY ECS delivers a call to a WCBRI station the called number IE in the SETUP message contains the dialed principal's extension. The extension can be different from the WCBRI station extension if the call is a hunt group call, TEG call, a redirected call from coverage, or a call routed by call vectoring.

WCBRI should not be designated as coverage points for many different principals.

### Form instructions

---

To administer a World Class BRI terminal, complete the standard as well as the following unique Station form fields.

Some WCBRI endpoints must be programmed with their assigned extension before they will accept an incoming call. Furthermore, many WCBRI endpoints can be programmed with multiple directory numbers, one of which must be their assigned extension. In this case, the WCBRI endpoint will accept calls delivered

to the endpoint with any of the programmed numbers. See also [“Multiple Subscriber Number \(MSN\) - Limited”](#) on page 6-214.

### Page 1 of the form

```

                                                                 Page 1 of X
STATION
Extension: 8003_
Type: WCBRI
Port: _____
Name: _____
Coverage Path 1: _____
Coverage Path 2: _____
Hunt-to Station: _____
BCC: 2
TN: 1
COR: 1
COS: 1
Data Restriction? n

STATION OPTIONS
Data Module? n

BRI OPTIONS
XID? n Fixed TEI? y TEI: __ 1-Step Clearing? y
Country Protocol: 1__ Endpt Init? y SPID: _____ Endpt ID: __
```

Screen 6-129. World Class BRI terminal Station form (Page 1 of X)

- **Type** — Enter **wcbri**.

### Page X of Y of the form (DATA MODULE)

```

                                     Page X of X
                                STATION
DATA MODULE
    Data Extension:
        Type: wcbri_____
        Port: _____
    Name: _____
    COS: 1_
    COR: 1_
    TN: 1__
    Multimedia? y
    MM Complex Voice Ext: xxxxxx

ABBREVIATED DIALING
List1:

SPECIAL DIALING OPTION:

CIRCUIT SWITCHED DATA ATTRIBUTES
Default Duplex: full    Default Mode: async    Default Speed: 1200

DATA MODULE CAPABILITIES
Default ITC: restricted
Default Data Application: M2_A
```

Screen 6-130. World Class BRI Station form — Data Module (Page X of Y)

This page displays only if Data Module is **y**.

```

                                     Page 3 of X
                                STATION
SITE DATA
    Room: _____
    Jack: _____
    Cable: _____
    Floor: _____
    Building: _____
    Headset? n
    Speaker? n
    Mounting: d
    Cord Length: 0_
    Set Color: _____

ABBREVIATED DIALING
List1: _____
List2: _____
List3: _____

Line Appearance: call-appr
```

Screen 6-131. World Class BRI Terminal Station form (Page 3 of X)

### Interactions

The unique capabilities of WCBRI terminals impact the way many DEFINITY ECS features work, as shown in the following table.



**Table 6-8. World Class BRI feature interactions**

| <b>Feature</b>   | <b>Support without limits</b> | <b>Support with limits</b> | <b>No support</b> | <b>Comments below</b> |
|--|-------------------------------|----------------------------|-------------------|-----------------------|
| A-law/mu-law companding selection                          |                               | x                          |                   | x                     |
| Abbreviated/delayed ringing                                |                               | x                          |                   | x                     |
| Abbreviated Dialing  |                               | x                          |                   | x                     |
| ACCUNET  | x                             |                            |                   |                       |
| Adjunct controlled splits                                  |                               | x                          |                   | x                     |
| Adjunct routing  |                               | x                          |                   | x                     |
| Administered repetitive call waiting tone interval         |                               |                            |                   | x                     |
| Administrable conference/intrusion tones                   |                               | x                          |                   | x                     |
| Administrable country options                              | x                             |                            |                   |                       |
| Administrable wait answer supervision timer                |                               | x                          |                   | x                     |
| Administration without Hardware                            |                               | x                          |                   | x                     |
| Agent after hour call work button                          |                               | x                          |                   | x                     |
| Agent AUX work/make busy button                            |                               | x                          |                   |                       |
| Agent-forced entry of CWC/strokes counts                   |                               |                            | x                 |                       |
| Agent hold with multiple call handling                     |                               |                            | x                 |                       |
| Agent hold without multiple call handling                  |                               |                            | x                 |                       |
| Agent-home (using CONVERSANT VIS)                          |                               | x                          |                   | x                     |
| Agent login/out  |                               | x                          |                   | x                     |
| Agent position   |                               | x                          |                   | x                     |
| Agent work states (unstaffed, AUX, WK, AVAIL, On-ACD, ACW) |                               |                            | x                 |                       |
| Agent work modes   |                               | x                          |                   | x                     |
| Agent with multiple splits                                 |                               | x                          |                   | x                     |
| Alternate Facilities Restriction Levels                    |                               |                            | x                 |                       |
| Alerting options   |                               |                            | x                 |                       |
| ASAI   |                               | x                          |                   | x                     |

*Continued on next page*

Table 6-8. World Class BRI feature interactions — *Continued*

| Feature   | Support without limits | Support with limits | No support | Comments below |
|---|------------------------|---------------------|------------|----------------|
| Assist  |                        | x                   |            | x              |
| Attendant Calling of Inward Restricted Stations                     | x                      |                     |            |                |
| Attendant call coverage point                                       |                        | x                   |            | x              |
| AUDIX   |                        | x                   |            | x              |
| AUDIX-embedded  |                        | x                   |            |                |
| AUDIX-leave message for callback without caller choice              | x                      |                     |            |                |
| AUDIX-leave message for callback with caller choice (via prompting) | x                      |                     |            |                |
| AUDIX - TN2181 emulation native support                             | x                      |                     | x          |                |
| AUDIX - transfer (switch and/or DCIU) - transfer into AUDIX         |                        |                     | x          |                |
| AUDIX - transfer (switch and/or DCIU) - transfer out of AUDIX       | x                      |                     |            |                |
| Automatic answering with zip tone                                   |                        |                     | x          | x              |
| Automatic Call Distribution   |                        | x                   |            | x              |
| Automatic Callback on busy  |                        |                     | x          |                |
| Automatic Callback on don't answer                                  |                        |                     | x          |                |
| Automatic Circuit Assurance (includes referrals)                    |                        | x                   |            | x              |
| Automatic Incoming Call Display                                     |                        |                     | x          |                |
| Authorization Code  |                        |                     | x          |                |
| Barrier Codes for Remote Access                                     | x                      |                     |            |                |
| Bridged Call Appearance   |                        | x                   |            | x              |
| Busy Verification of Terminals and Trunks                           |                        |                     | x          |                |
| Call Coverage-answer group  | x                      |                     |            |                |
| Call Coverage-attendant as coverage point                           |                        | x                   |            | x              |
| Call Coverage-callback  |                        |                     | x          |                |

*Continued on next page*

**Table 6-8. World Class BRI feature interactions — Continued**

| Feature  | Support without limits | Support with limits | No support | Comments below |
|--|------------------------|---------------------|------------|----------------|
| Call Coverage-caller response interval           |                        | x                   |            | x              |
| Call Coverage-consult                            |                        | x                   |            | x              |
| Call Coverage-cover active redirection           | x                      |                     |            |                |
| Call Coverage-cover for PCOL calls               |                        | x                   |            | x              |
| Call Coverage-covering point don't answer timing | x                      |                     |            |                |
| Call Coverage-go to cover                        |                        |                     | x          |                |
| Call Coverage-hunt group as coverage point       | x                      |                     |            |                |
| Call Coverage-incoming call identification       |                        |                     | x          |                |
| Call Coverage-multiple coverage paths            | x                      |                     |            |                |
| Call Coverage paths                              | x                      |                     |            |                |
| Call Coverage-point don't answer timing          | x                      |                     |            |                |
| Call Coverage-redirect notification signal       |                        |                     | x          |                |
| Call Coverage-send all calls                     |                        | x                   |            | x              |
| Call Coverage-temporary bridged appearance       |                        |                     | x          |                |
| Call Coverage tone                               | x                      |                     |            |                |
| Call Coverage-VDN in a coverage point            | x                      |                     |            |                |
| Call Forwarding-All Calls                        |                        | x                   |            | x              |
| Call Forwarding-Busy and Don't Answer            |                        | x                   |            | x              |
| Call Forwarding-Busy Don't Answer with override  | x                      |                     |            |                |
| Call Forwarding off-net                          | x                      |                     |            |                |
| Call hold  |                        |                     | x          |                |
| Call master ACD agent terminal                   |                        |                     | x          |                |
| Call Park  |                        | x                   |            | x              |
| Call Pickup                                      |                        | x                   |            | x              |
| Call response interval                           |                        | x                   |            | x              |

*Continued on next page*

**Table 6-8. World Class BRI feature interactions — *Continued***

| <b>Feature</b>                                       | <b>Support without limits</b> | <b>Support with limits</b> | <b>No support</b> | <b>Comments below</b> |
|--|-------------------------------|----------------------------|-------------------|-----------------------|
| Call Vectoring                                       |                               | x                          |                   |                       |
| Call Vectoring-ANI/II digits routing                 | x                             |                            |                   |                       |
| Call Vectoring-call prompting/DIVA                   |                               | x                          |                   |                       |
| Call Vectoring-route to number with/without coverage | x                             |                            |                   |                       |
| Call Vectoring-VDN in coverage path                  | x                             |                            |                   |                       |
| Call Vectoring-VDN of origin announcements           |                               | x                          |                   |                       |
| Call Vectoring-VDN of origin display                 |                               |                            | x                 |                       |
| Call Vectoring-VDN return destination                |                               | x                          |                   | x                     |
| Call Vectoring-without call choice                   | x                             |                            |                   |                       |
| Call Vectoring-with caller choice (via prompting)    | x                             |                            |                   |                       |
| Call Waiting Termination                             |                               |                            | x                 |                       |
| Call work codes                                      |                               |                            | x                 |                       |
| Calling number display                               |                               | x                          |                   | x                     |
| Calling number display (SID/ANI/Extn ID)             |                               | x                          |                   | x                     |
| CDR account codes                                    | x                             |                            |                   |                       |
| CDR for inter-switch calls                           | x                             |                            |                   |                       |
| CDR Privacy  | x                             |                            |                   |                       |
| CDR-periodic pulse metering                          |                               | x                          |                   | x                     |
| CDR-splitting of records                             | x                             |                            |                   |                       |
| Code Call Access/chime paging                        | x                             |                            |                   |                       |
| Common second delay announcement for all splits      | x                             |                            |                   |                       |
| Conference-terminal                                  |                               | x                          |                   |                       |
| Controlled Restriction                               | x                             |                            |                   |                       |
| COR  | x                             |                            |                   |                       |

*Continued on next page*

**Table 6-8. World Class BRI feature interactions — *Continued***

| <b>Feature</b>  | <b>Support without limits</b> | <b>Support with limits</b> | <b>No support</b> | <b>Comments below</b> |
|---|-------------------------------|----------------------------|-------------------|-----------------------|
| COR-Three way checking for conferences, transfers & call redirections | x                             |                            |                   |                       |
| COS   | x                             |                            |                   |                       |
| Consult   |                               |                            | x                 | x                     |
| Cut-through operation   |                               |                            | x                 |                       |
| Data Call Setup   | x                             |                            |                   | x                     |
| Data Call Setup dialing-alphanumeric                                  |                               | x                          |                   | x                     |
| Data Call Setup dialing-default                                       |                               | x                          |                   | x                     |
| Data Call Setup dialing-hot line                                      | x                             |                            |                   |                       |
| Data Call Setup dialing-single line                                   | x                             |                            |                   |                       |
| Data Call Setup dialing-multiple line                                 |                               |                            | x                 |                       |
| Data Privacy  | x                             |                            |                   |                       |
| Data Restriction  | x                             |                            |                   |                       |
| DCS Alphanumeric Display for Terminals                                |                               |                            | x                 |                       |
| Display-voice terminal  |                               |                            | x                 |                       |
| DCS Automatic Circuit Assurance                                       |                               | x                          |                   | x                     |
| DCS Automatic Callback  |                               | x                          |                   | x                     |
| DCS Busy Verification of Terminals and Trunks                         |                               |                            | x                 |                       |
| DCS Call Coverage off premises  | x                             |                            |                   |                       |
| DCS Call Forwarding All Calls   |                               | x                          |                   |                       |
| DCS Call Waiting & priority calling                                   |                               |                            | x                 |                       |
| DCS Distinctive Ringing   |                               | x                          |                   | x                     |
| DCS-Enhanced  | x                             |                            |                   |                       |
| DCS Leave Word Calling  |                               | x                          |                   | x                     |
| DCS Multiappearance Conference/Transfer                               |                               |                            | x                 |                       |
| DID   | x                             |                            |                   |                       |

*Continued on next page*

**Table 6-8. World Class BRI feature interactions — *Continued***

| <b>Feature</b>                         | <b>Support without limits</b> | <b>Support with limits</b> | <b>No support</b> | <b>Comments below</b> |
|--|-------------------------------|----------------------------|-------------------|-----------------------|
| DID busy back                          | x                             |                            |                   |                       |
| DID recall                             | x                             |                            |                   |                       |
| Dial Access to Attendant               | x                             |                            |                   |                       |
| Dialed Number Identification Service   |                               |                            | x                 | x                     |
| DIOD Trunks                            | x                             |                            |                   |                       |
| Direct Agent Calling - via adjunct     |                               | x                          |                   | x                     |
| Direct Department Calling Distribution |                               | x                          |                   | x                     |
| Direct Department Calling (DDC)        |                               | x                          |                   |                       |
| Direct Inward Dialing                  | x                             |                            |                   |                       |
| Direct Outward Dialing                 | x                             |                            |                   |                       |
| Display-agent terminal                 |                               | x                          |                   |                       |
| Display-called number                  |                               | x                          |                   |                       |
| Display-calling number                 |                               | x                          |                   |                       |
| Display-city of origin                 |                               |                            | x                 |                       |
| Display-connected party                |                               |                            | x                 |                       |
| Display message translation            |                               |                            | x                 |                       |
| Display-queue of origin                |                               |                            | x                 |                       |
| Display-queue status                   |                               |                            | x                 |                       |
| Display-VuStats                        |                               |                            | x                 |                       |
| Distinctive Alerting (ringing)         |                               | x                          |                   | x                     |
| Distinctive Alerting-administrable     |                               | x                          |                   |                       |
| DNIS display                           |                               |                            | x                 | x                     |
| Drop (button operation)                |                               | x                          |                   | x                     |
| DS1-CO/FX/WATS Trunk Service           | x                             |                            |                   |                       |
| DS1 robbed bit AVD tie trunk           | x                             |                            |                   |                       |
| DS1 tie trunk service                  | x                             |                            |                   |                       |
| DS1 OPS lines                          |                               |                            | x                 |                       |

*Continued on next page*

**Table 6-8. World Class BRI feature interactions — *Continued***

| <b>Feature</b>                                       | <b>Support without limits</b> | <b>Support with limits</b> | <b>No support</b> | <b>Comments below</b> |
|--|-------------------------------|----------------------------|-------------------|-----------------------|
| DS1 - 32-channel interface                           | x                             |                            |                   |                       |
| EAS-agents in multiple skills                        |                               | x                          |                   |                       |
| EAS-direct agent calling via logical agent ID        |                               | x                          |                   |                       |
| EAS-expert agent distribution                        | x                             |                            |                   |                       |
| EAS-logical agent login                              | x                             |                            |                   |                       |
| EAS-VDN skills                                       | x                             |                            |                   |                       |
| Electronic Tandem Network                            | x                             |                            |                   |                       |
| Enhanced terminal administration                     | x                             |                            |                   |                       |
| Extended Trunk Access                                | x                             |                            |                   |                       |
| Extension steering                                   | x                             |                            |                   |                       |
| Facility Busy Indication                             |                               |                            | x                 |                       |
| Facility Restriction Level and Traveling Class Marks | x                             |                            |                   |                       |
| Facility Test Calls                                  |                               |                            | x                 |                       |
| Flexible Dial Plan                                   | x                             |                            |                   |                       |
| Forced entry of account codes                        | x                             |                            |                   |                       |
| Foreign Exchange (FX) Access                         | x                             |                            |                   |                       |
| Hold-single line multiappearance                     |                               |                            | x                 |                       |
| Hold-Automatic                                       |                               |                            | x                 |                       |
| Hospitality-Automatic Wakeup                         |                               | x                          |                   | x                     |
| Hospitality-check in/check out                       |                               |                            |                   |                       |
| Hospitality-Do Not Disturb                           |                               | x                          |                   | x                     |
| Hospitality-Emergency Access to the Attendant        | x                             |                            |                   |                       |
| Hospitality-housekeeping status                      |                               | x                          |                   |                       |
| Hospitality-message waiting notification             |                               | x                          |                   | x                     |
| Hospitality-Single-Digit Dialing and Mixed Numbering | x                             |                            |                   |                       |

*Continued on next page*

**Table 6-8. World Class BRI feature interactions — Continued**

| Feature  | Support without limits | Support with limits | No support | Comments below |
|--|------------------------|---------------------|------------|----------------|
| Host computer access (via DCP/EIA ports)         | x                      |                     |            |                |
| Hot Line Service                                 |                        |                     | x          |                |
| Hunting/Hunt Groups (DDCS & UCD Only)            | X                      |                     |            |                |
| Hunting-Trunk Group                              | x                      |                     |            |                |
| Inbound Call Management (ICM) with host via ASAI |                        |                     |            |                |
| Incoming ANI on R2-MFC                           |                        |                     | x          |                |
| Intercept Treatment                              | x                      |                     |            |                |
| Intercom Automatic                               |                        | x                   |            |                |
| Intercom Dial                                    |                        | x                   |            |                |
| Inter PBX Attendant Calls                        |                        |                     | x          |                |
| International trunks                             | x                      |                     |            |                |
| Integrated Directory                             |                        |                     | x          |                |
| ISDN-bearer capability class                     | x                      |                     |            |                |
| ISDN-codeset conversion                          |                        |                     | x          |                |
| ISDN-connected party display                     |                        |                     | x          |                |
| ISDN-QSIG call diversion                         |                        | x                   |            | x              |
| ISDN-QSIG call transfer                          |                        |                     | x          |                |
| ISDN-QSIG name and number                        |                        | x                   |            |                |
| Last Number Dialed                               |                        | x                   |            |                |
| Leave Word Calling (switch)                      |                        | x                   |            |                |
| Line Lockout with warning                        |                        | x                   |            |                |
| Line/feature status indication                   |                        |                     | x          |                |
| List call forwarding                             | x                      |                     |            |                |
| Loudspeaker Paging Access with answerback        |                        | x                   |            | x              |

*Continued on next page*



**Table 6-8. World Class BRI feature interactions — Continued**

| Feature   | Support without limits | Support with limits | No support | Comments below |
|---|------------------------|---------------------|------------|----------------|
| Loudspeaker Paging Access Deluxe with answerback        |                        | x                   |            | x              |
| Malicious Call Trace                                    |                        | x                   |            | x              |
| Manual answering with ringing                           |                        |                     | x          |                |
| Manual Message Waiting                                  |                        |                     | x          |                |
| Manual Originating Line Service                         |                        |                     | x          |                |
| Manual Signaling  |                        |                     | x          |                |
| Message Retrieval-from display set                      |                        |                     | x          |                |
| Message Retrieval-message scrolling                     |                        |                     | x          |                |
| Message Retrieval-password                              |                        |                     | x          |                |
| Message Retrieval-print messages (demand print)         |                        | x                   |            |                |
| Message Retrieval-voice message retrieval (synthesized) | x                      |                     |            |                |
| Message Sequence Tracer (PRI, DCIU)                     | x                      |                     |            |                |
| Message waiting indication-audible                      | x                      |                     |            |                |
| Message waiting indication-AUDIX outcalling             | x                      |                     |            |                |
| Message waiting indication-automatic                    |                        |                     | x          |                |
| Messaging Server  |                        |                     | x          |                |
| Modem Pooling   |                        |                     | x          |                |
| Modified Misoperations                                  |                        |                     | x          |                |
| Multiappearance Preselection and Preference             |                        |                     | x          |                |
| Multiple Call Handling                                  |                        |                     | x          |                |
| Music-on-Hold Access-held calls                         |                        | x                   |            | x              |
| Music-on-Hold-conference/terminal calls                 |                        | x                   |            | x              |
| Music-on-Hold Access transferred trunk calls            |                        | x                   |            | x              |

*Continued on next page*

**Table 6-8. World Class BRI feature interactions — *Continued***

| <b>Feature</b>                                    | <b>Support without limits</b> | <b>Support with limits</b> | <b>No support</b> | <b>Comments below</b> |
|---|-------------------------------|----------------------------|-------------------|-----------------------|
| Network Access-public (LEC/AT&T/other carriers)   | x                             |                            |                   |                       |
| Network Access-Private premises based             | x                             |                            |                   |                       |
| New reason for redirection                        |                               | x                          |                   |                       |
| Night Service disconnect timer                    | x                             |                            |                   |                       |
| Night Service-Night Console                       |                               |                            | x                 |                       |
| Night Service-Night Station Service               |                               | x                          |                   | x                     |
| Night Service-Trunk Answer from any Station       |                               | x                          |                   | x                     |
| Night Service-Trunk Group                         |                               | x                          |                   | x                     |
| No disconnect supervision trunk operation         | x                             |                            |                   |                       |
| Off-Premises Station                              |                               |                            | x                 |                       |
| PC Interface (DCP Port/Data Module, EIA Port/ADU) |                               |                            | x                 |                       |
| PC/ISDN   |                               |                            | x                 |                       |
| Personal Central Office Line                      |                               |                            | x                 |                       |
| Personalized Ringing                              |                               | x                          |                   | x                     |
| Power Failure Transfer                            |                               |                            | x                 |                       |
| Public CO register recall                         | x                             |                            |                   |                       |
| Priority Calling                                  |                               | x                          |                   | x                     |
| Privacy-Manual Exclusion                          |                               | x                          |                   | x                     |
| Pull Transfer                                     |                               |                            | x                 |                       |
| Queue Status Indications                          |                               |                            | x                 |                       |
| Radio paging access                               | x                             |                            |                   |                       |
| Recall Signaling                                  |                               |                            | x                 |                       |
| Recorded Announcement                             | x                             |                            |                   |                       |
| Recorded Telephone Dictation Access               | x                             |                            |                   |                       |
| Redirect alerting call service                    |                               | x                          |                   |                       |

*Continued on next page*

**Table 6-8. World Class BRI feature interactions — *Continued***

| Feature                                   | Support without limits | Support with limits | No support | Comments below |
|---|------------------------|---------------------|------------|----------------|
| Return call (call display)                |                        |                     | x          |                |
| Ringback Queuing                          |                        |                     | x          | x              |
| Ringer Cutoff                             |                        |                     | x          |                |
| RONA                                      |                        | x                   |            |                |
| Security-Authorization Code Violation     |                        |                     | x          |                |
| Security Violation Notification           |                        |                     | x          |                |
| Service Observing                         |                        | x                   |            | x              |
| Set Value                                 |                        | x                   |            |                |
| Split Supervisor                          |                        |                     | x          | x              |
| Stroke Counts                             |                        |                     | x          |                |
| Switch Based Enhancements                 | x                      |                     |            |                |
| Terminal Translation Initialization (TTI) |                        | x                   |            | x              |
| Terminating Extension Group               |                        | x                   |            |                |
| Third-Party Call Control                  |                        | x                   |            | x              |
| Third-Party Domain                        |                        | x                   |            | x              |
| Third-Party Domain (station/split)        |                        |                     | x          | x              |
| Tone Forward Disconnect                   |                        |                     | x          |                |
| Touch-Tone Dialing                        | x                      |                     |            |                |
| Transfer                                  |                        |                     | x          |                |
| VDN of Origin Announcements               |                        | x                   |            |                |
| VDN of Origin Display                     |                        |                     | x          |                |
| VDN Return Destination                    |                        | x                   |            | x              |
| VuStats                                   |                        |                     | x          |                |

- A-law/mu-law companding selection

Companding selections for the WCBRI stations must be compatible with the switch companding on the System-Parameters Customer-Options form.

- Abbreviated/delayed ringing  
You cannot select Alternate-ring values of no-ring, abbreviated-ring, and delayed-ring. You can enable automatic A/D transition for calls to a WCBRI station. This allows another user, bridged to a WCBRI station, to use the feature.
- Abbreviated Dialing  
Feature buttons are not supported. Use FAC codes.
- Adjunct controlled splits  
Extra phone functions such as hold or transfer are unavailable to an agent in an adjunct-controlled split.
- Adjunct routing  
An adjunct provides priority ringing to a call routed by the adjunct. A WCBRI station or country protocol may not fully support priority ringing.
- Administered repetitive call-waiting tone interval  
Call-waiting tones are not available on WCBRI stations.
- Administrable conference/intrusion tones  
Conference and intrusion tones are heard at the WCBRI terminal. You cannot administer a verify button on the terminal.
- Administrable wait answer supervision timer  
A call made from or to a WCBRI station rings for the allotted time. If the feature is active, the caller hears intercept tone and the call stops ringing at the terminal.
- Administration without Hardware  
You can administer WCBRI stations without port information.
- Agent after-hour call work button  
Because WCBRI stations do not support feature buttons, use FACs.
- Agent login/logout  
Agents use a FAC to log in or log out. If an agent receives a call while on-hook (to enter an FAC), the agent can miss the call. The agent may be unable to hear dial tone (in order to enter the FAC) after going on-hook if the split is continuously busy with calls.
- Agent-home (using CONVERSANT VIS)  
WCBRI stations are not suitable for home-agent stations because of feature limitations.
- Agent position, Agent work modes  
Because WCBRI stations do not support feature buttons, an agent uses a FAC to establish or change work modes.

- Agent with multiple splits

The WCBRI station can accept calls delivered with each logged-in split extension.

- ASAI

WCBRI stations are not suitable as ASAI agent-voice terminals because WCBRI stations do not have administrable buttons, lamp control, and display control. Use the stations for ASAI with these limitations:

- WCBRI stations do not support the message-waiting lamp, but audible-message waiting indication is available.
- The system considers the WCBRI station as a single-line analog station with no display, no special-alerting pattern, and no system control of off-hook/on-hook status.

WCBRI stations can answer switch-classified calls that ASAI uses for outgoing call management. WCBRI stations do impose some limitations for user-classified calls. For example, when an ASAI adjunct initiates a user-classified call and the originator is on-hook, the system selects an originator's call appearance and forces it off-hook. WCBRI stations do not support this processing. Instead, the system treats a WCBRI terminal as an analog terminal and waits 5 seconds for the WCBRI-originating station to go off-hook. If the originating station is off-hook with a dial tone, the system completes dialing to the destination.

- Assist

An agent at a WCBRI station can use only a FAC to request supervisor assistance. Since an active call is the reason for needing assistance, Assist is not available to WCBRI users. A WCBRI station does not provide the agent with a hold button.

- Attendant call-coverage point

A WCBRI station can use an attendant as a coverage point. Because a WCBRI terminal is treated by the system as an analog terminal, it cannot have a simulated bridged appearance.

- AUDIX

WCBRI stations can call AUDIX for messages and can use AUDIX as a coverage point. Although WCBRI stations do not support message lamps, they do support audible message waiting. Because WCBRI stations do not support Conference, they also do not support Call Conference into AUDIX.

- Automatic answering with zip tone

Automatic answering with zip tone is dependent upon the selected call appearance, which is not supported for WCBRI stations.

- Automatic Call Distribution

WCBRI stations do not support release or drop buttons for ACD call disconnecting. Agents can drop a call by going on-hook. If the WCBRI station has a drop button that sends either a DISCONNECT or RELEASE COMPLETE message during an active call, then the call is dropped.

WCBRI stations do not support either stroke counts or call work codes. Administer these features via feature buttons. WCBRI stations do not support feature buttons.

ACD calls delivered to a WCBRI station send the hunt-group extension, not the station extension, as the called number in the SETUP message. For the WCBRI station to accept such calls, it must either:

- Not check the delivered called number
- Administer with additional directory numbers (hunt-group extensions) that can be delivered in SETUP messages as called numbers

The system allows one active call per hunt-group extension. You can avoid this limitation by using Call Vectoring to route two calls to a single data-module extension.

- Automatic circuit assurance (includes referrals)

Use a WCBRI station as a remote-referral destination for ACA calls. Use speech-synthesis boards to voice the ACA to the user. If the WCBRI station is an A-law terminal, use a British or Italian speech-synthesis board; if Mu-law, use a North American speech-synthesis board.

- Bridged Call Appearance (single-line, multiappearance)

WCBRI stations support bridging features in only one direction. Administer a WCBRI station as a bridged appearance on a multiappearance station. WCBRI stations cannot support bridged appearances for other extensions.

- Call Coverage-consult

WCBRI stations do not support feature buttons, therefore WCBRI stations support Call Coverage-consult when the WCBRI terminal is the covered user, but not when it is the covering user.

- Call Coverage-cover for PCOL calls

Call Coverage-cover for PCOL calls is supported for WCBRI when the WCBRI terminal is used as a covering user.

- Call Coverage-caller response interval

WCBRI stations do not support feature buttons. The only thing a user can do during the interval is hang up.

- Call Coverage-send all calls

Activate via the FAC.

- Call Forwarding All Calls

A WCBRI user can activate Call Forwarding All Calls by using a FAC, but there is no visual indication that the feature is active. When a call is forwarded, the system applies a burst ring to the forwarding terminal.

The system does not send a signal IE in the INFO message to a WCBRI terminal administered for country protocols 2 (Australia), etsi, or 6 (Singapore).

- Call Forward-Busy and Don't Answer

A WCBRI user can access Call Forward-Busy and Don't Answer with a FAC.

- Call Park

A user cannot park a call from a WCBRI terminal. A WCBRI user can pick up a parked call using a FAC.

- Call Pickup

A WCBRI terminal can be part of a pickup group and can answer calls directed to other members of the group by using a FAC.

- Caller response interval

WCBRI stations do not support feature buttons. The only thing a user can do during the interval is hang up.

- Call Vectoring-distinctive alerting (ringing)

The switch controls a WCBRI ringer via a signal IE. The country protocol assigned to a WCBRI station impacts signal IE. Specifically, the signal IE is not permitted for country protocol 2 (Australia) or etsi, and station ringing is controlled solely by the WCBRI station. In addition, the signal IE is supported only in a SETUP message for country protocol 6. (Singapore)

For all other situations, the ringer response to the different signal IE values depends upon station characteristics and local station options that modify station ringing.

- Calling number display

The system sends a calling number IE message to a WCBRI terminal or, if the call is an incoming PRI-trunk call, the system tandems the received calling-number IE to the terminal. Some WCBRI terminals cannot display the information.

- Calling number display (SID/ANI/Extn ID)

The system delivers the calling party number IE received in a PRI setup message to a WCBRI station. The station can display the number.

- Consult

WCBRI stations support Consult for the covered user, but not for the covering user.

- Data Call Setup-dialing

Basic-terminal dialing is supported for WCBRI terminals. The WCBRI terminal controls the digits sent to the system.
- Data Call Setup-alphanumeric

Data Call Setup-alphanumeric is supported for WCBRI terminals that provide alphanumeric characters in keypad IEs during call setup.
- Data Call Setup-default

Data Call Setup-default is supported if the terminal sends either a sending complete IE (0xa1) or a called-party number IE with no digits specified in the SETUP message or subsequent information message.
- DCS Attendant Call Coverage Point

A WCBRI station can use an attendant as a coverage point. Because a WCBRI terminal is treated by the system as an analog terminal, it cannot have a simulated bridged appearance.
- DCS Automatic Circuit Assurance

Use a WCBRI station as a remote-referral destination for ACA calls. You must use speech-synthesis boards to voice the ACA to the user. If the WCBRI station is an A-law terminal, use a British or Italian speech-synthesis board; if Mu-law, use a North American speech-synthesis board.
- DCS Automatic Callback

A WCBRI terminal cannot activate DCS Automatic Callback. A user cannot key the FAC and the extension to activate DCS Automatic Callback because the switch allows this procedure for held calls. Call hold is not available to WCBRI users.

A remote-caller can activate DCS Automatic Callback for a WCBRI terminal when the terminal is busy or does not answer. When the terminal is on-hook, the system alerts the caller. When the caller is off-hook, the system generates a new call and alerts the WCBRI terminal.
- DCS Distinctive Alerting (Ringing)

The switch controls a WCBRI ringer via a signal IE. The country protocol assigned to a WCBRI station impacts signal IE. Specifically, signal IE is not permitted for country protocol 2 (Australia) or etsi, and station ringing is controlled solely by the WCBRI station. In addition, the signal IE is supported in a SETUP message for country protocol 6. (Singapore)

For all other situations, the ringer response to different signal IE values depends upon station characteristics and local station options that modify station ringing.



- DCS Leave Word Calling

It is possible to leave a DCS Leave Word Calling message for a WCBRI terminal user. The user can retrieve the message using the voice-retrieval message FAC.

A WCBRI terminal can leave a message for a user on a different DCS node by dialing the LWC send a message FAC and the remote extension.

- Dialed number identification service

WCBRI stations do not support DNIS. Calls delivered to WCBRI stations have the dialed-principal's extension as the called-party number.

- Direct Agent Calling - via adjunct

The special-alert pattern (ring ping) used to deliver direct agent calls may not be supported in all WCBRI stations or country protocols.

- Direct department calling distribution.

Calls delivered to WCBRI stations have the DDC-group extension as the called-party number.

- Distinctive Alerting (Ringing)

The switch controls a WCBRI ringer via a signal IE. The country protocol assigned to a WCBRI station impacts signal IE. Specifically, signal IE is not permitted for country protocol 2 (Australia) or etsi, and station ringing is controlled solely by the WCBRI station. In addition, the signal IE is supported in a SETUP message for country protocol 6. (Singapore)

For all other situations, the ringer response to different signal IE values depends upon station characteristics and local station options that modify station ringing.

- DNIS display

WCBRI stations do not support DNIS Display. WCBRI stations can display information in the called-party number IE, but this information is different from called-number information received over PRI.

- Drop

The switch provides limited support for Drop on WCBRI stations. If a WCBRI station has a Drop button that sends a DISCONNECT or RELEASE COMPLETE message to DEFINITY 5.4 during an active call, the call drops. Do not use the Drop button on the WCBRI station to selectively drop the last party added to a conference call.

- Hospitality-Automatic Wakeup

Hospitality-Automatic Wakeup is supported with the TN725B speech-synthesis board and by using voice prompting and the automatic wakeup FAC. The display is under the control of the WCBRI terminal.

- Hospitality-controlled restriction

Hospitality-controlled restriction allows an operator on the Property Management System to change a room's restrictions. WCBRI does not interact with this function.

A WCBRI terminal cannot be a front-desk station and cannot be used to change restrictions from the front desk.
- Hospitality-Do Not Disturb

Hospitality-Do Not Disturb is supported by voice prompting and the Do Not Disturb FAC.
- Hospitality-Message Waiting Notification

WCBRI terminals do not have buttons and cannot notify other extensions. A WCBRI terminal can be notified of waiting messages by setting the audible message waiting field on the Station form to yes.
- ISDN-QSIG call diversion

A WCBRI user can activate ISDN-QSIG call diversion by using a FAC, but there is no visual indication that the feature is active. When a call is forwarded, the system applies a burst ring to the forwarding terminal.

The system does not send a signal IE in the INFO message to a WCBRI terminal administered for country protocols 2 (Australia), etsi, or 6 (Singapore).

Display updates of QSIG call diversion are not supported for WCBRI terminals.
- Loudspeaker Paging Access w/answerback

A WCBRI user can activate this feature via an FAC.
- Loudspeaker Paging Access Deluxe w/answerback

A WCBRI user can activate this feature via an FAC.
- Malicious Call Trace

A WCBRI user can activate this feature for another station from a WCBRI station by entering a FAC. When the WCBRI user hangs up, the trunk is not released.
- Multiple Subscriber Number (MSN) - Limited

The ISDN standard MSN feature lets you assign multiple extensions to a single BRI endpoint. The DEFINITY ECS MSN feature works with BRI endpoints that allow the Channel ID IE to be encoded as "preferred." The endpoint must be administered as the far end of an NT-side ISDN-BRI trunk group. Also, the customer must use the Uniform Dial Plan (UDP) feature to assign the desired extensions to the "node" at the far end of the trunk group.

- Music-on-Hold-Access held calls

WCBRI stations cannot place a call on hold. If a WCBRI station is placed on hold by another station, the WCBRI user hears the music provided by Music-on-Hold-Access held calls.
- Music-on-Hold conference/terminal calls

WCBRI stations cannot initiate a conference. If a WCBRI station is placed on hold for conference by another station, the WCBRI user hears the music provided by Music-on-Hold conference/terminal calls.
- Music-on-Hold Access transferred trunk calls

WCBRI stations cannot place a call on hold for transfer. If a WCBRI station is placed on hold for transfer by another station, the WCBRI user hears the music provided by Music-on-Hold-Access transferred-trunk calls.
- Night Service (Night Station Service)

WCBRI stations can serve as night stations, but can handle only one call at a time.
- Night Service (Trunk Answer from any Station)

A WCBRI station can answer a TAAS call by dialing the FAC.
- Night Service (Trunk Group)

Because WCBRI stations do not support feature buttons, do not assign a WCBRI station the feature button required to activate Night Service-Trunk Group. A WCBRI station can serve as a night-service destination once this feature is activated by another station.
- Personalized Ringing

Personalized Ringing is controlled by the WCBRI terminal.
- Priority Calling

WCBRI station users can access Priority Calling with the FAC.
- Privacy-Manual Exclusion

WCBRI stations lack the feature buttons necessary to access Privacy-Manual Exclusion. A WCBRI station can bridge to another multiappearance station that has the necessary feature button. When the WCBRI station is bridged onto a call where another station activates exclusion, the WCBRI station is removed from the call. If exclusion is activated before the WCBRI station attempts to bridge onto the call, the call is blocked.
- Ringback Queuing

Ringback Queuing is blocked for multiappearance stations. WCBRI stations are considered multiappearance by the software.

- **Service Observing**

WCBRI cannot support Service Observing because it uses feature buttons. Another station can use Service Observing to observe an active call at a WCBRI station.
- **Split Supervisor**

WCBRI stations are not suitable to be split supervisors because the stations have limited functions — for example, no displays and the inability to activate Service Observing.
- **Terminal Translation Initialization**

Terminal Translation Initialization is supported for terminals that provide SPID initialization, including Nation ISDN BRI terminals, but not other WCBRI terminals.
- **Third-Party Call Control**

Third-party selective hold and third-party merge are not supported if the third-party controlled call is on a WCBRI station. Third-party selective drop is supported.
- **Third-Party Domain (station)**

The system treats a WCBRI station as an analog station. It waits 5 seconds for the station to go off-hook before delivering a call to the station or originating a call for a station.
- **Third-Party Domain (station/split)**

The system treats a WCBRI station as an analog station. It waits 5 seconds for the station to go off-hook before delivering a call to the station or originating a call.
- **VDN Return Destination**

Always administer 1-step clearing to yes. If you administer 1-step clearing to no, a call does not terminate again at the WCBRI terminal when the user drops from the call. If 1-step clearing is set to yes, the call terminates again at the WCBRI terminal.

## **PC Interface Administration**

## EIA Interface

---

EIA Interface provides an alternative to digital terminal data modules and modular processor data modules within the system for interconnection between EIA 232-compatible digital terminal equipment and the system. The EIA Interface consists of a data-line circuit-pack port and an asynchronous data unit (ADU).

### Administration Commands

---

Use the following commands to access the EIA Interface.

#### Required forms

---

| Form                      | Field  | Page                  |
|---------------------------|--|-----------------------|
| Station (multiappearance) | ■ Feature Button Assignments<br>— data-ext (Ext:___) | <a href="#">6-28</a>  |
| Data Module (all forms)   | ■ All  | <a href="#">7-115</a> |

### Detailed description

---

EIA Interface supports speeds of LOW, 300, 1200, 2400, 9600, and 19200 bps.

A data-line port differs from a data module when functions (options) are set in the system rather than at the hardware. Users do not have access to the data-line port, but can access all data-module-related functions. Users can examine and change such items as speed and parity via a menu-driven selection mode at the DTE. You can use the management terminal to examine and change functions.

Use a data-line port in conjunction with an ADU to connect the system to:

- Administrative terminals
- The outside world via an integrated modem pool card or external modem pool resource
- A PMS interface
- Asynchronous data terminals
- Journal printers

Available ADUs are the Z3A1, Z3A2, and Z3A4.

Connect the DCE to a data-line port using a null modem.

## **Considerations**

---

- There is no limit to the number of data-line circuit packs the system can support, subject to slot availability and the system limit of digital-data endpoints.
- The system does not provide flow-control signaling.

## **Interactions**

---

- **Data Terminal Dialing**  
Grant Data Terminal (Keyboard) Dialing permission before you use keyboard dialing.

## PC Interface

---

The personal computer (PC) Interface consists of the PC/PBX Connection, the PC/PBX platforms, and PC/ISDN Platform product family. These products are used with DEFINITY ECS to provide users of IBM-compatible PCs fully-integrated voice and data workstation capabilities. (PC/PBX Connection is a voice and data call-management application.)

### Administration Commands

---

Use the following commands to access the PC Interface.

#### Required forms

---

| Form                        | Field | Page                  |
|-----------------------------|-------|-----------------------|
| Station (personal computer) | ■ All | <a href="#">6-153</a> |

---

### Detailed description

---

Two groups of different configurations are available for PC Interface: group 1 uses Digital Communications Protocol (DCP) and group 2 uses the ISDN-BRI (Basic Rate Interface) protocol.

The group 1 configurations consist of DCP configurations that use a PC/PBX Interface card (formerly DCP expansion card) in the PC to link to the switch. Group 1 (shown in [Figure 6-1](#)) uses the following connections:

- The PC Interface card plugs into an expansion slot on the PC. The card has 2 standard 8-pin modular jacks (line and phone).
- The digital phone plugs into the phone jack on the PC Interface card.
- The line jack on the card provides a digital port connection to DEFINITY ECS.
- The distance between the PC Interface card and the PBX should be no more than 1524m for 24-gauge wire or 1219m for 26-gauge wire.



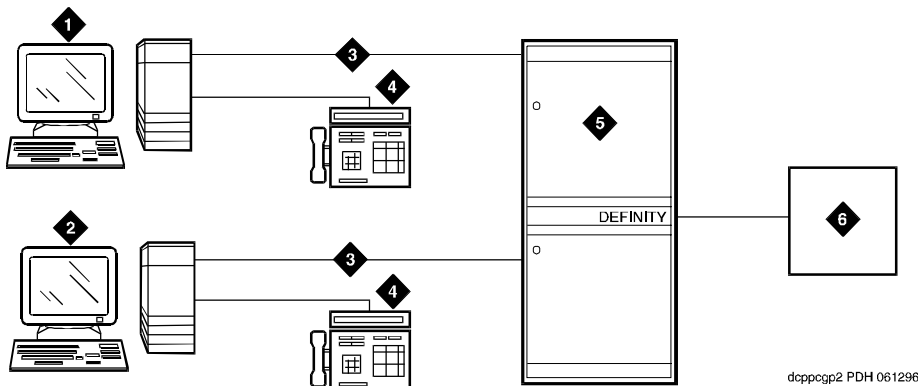

dcppcgp2 PDH 061296

### Figure Notes

- |  |   |
|--|---|
| 1. IBM-compatible PC with DCP Interface card | 4. DCP voice terminal   |
| 2. IBM-compatible PC with DCP Interface card | 5. DEFINITY ECS (TN754B, TN2181, or TN2224 digital-line circuit pack) |
| 3. DCP                                       | 6. Host   |

Figure 6-1. DCP PC interface configuration (Group 1)

The group 2 configurations link to the switch using a PC/ISDN Interface card installed in the PC. This group can include a stand-alone PC terminal, or up to four voice terminals, handsets, or headsets. Group 2 (shown in [Figure 6-2](#)) uses PC/ISDN Interface cards (up to four cards) which plug into expansion slots on the PC. These cards each provide 2 standard 8-pin modular-jack connections for both line connections (to the switch) and phone connections. A standard 4-pin modular jack is also available for use with a handset or headset.

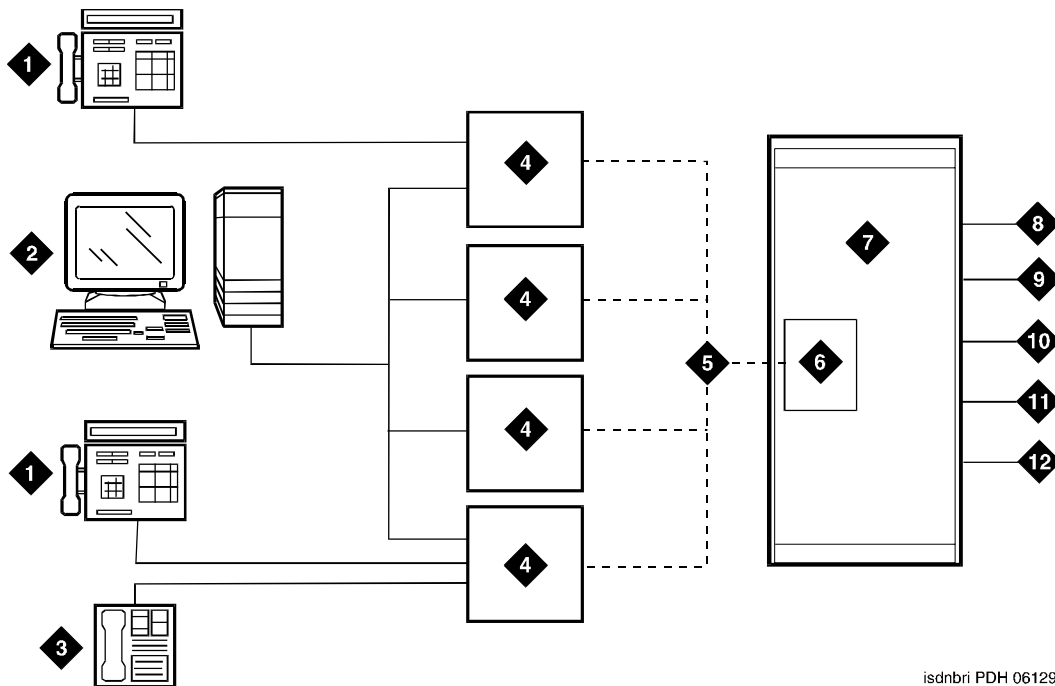

isdnbri PDH 061296

**Figure Notes**

- |   |                     |
|---|---------------------|
| 1. ISDN voice terminal  | 7. DEFINITY ECS     |
| 2. PC with application  | 8. PRI trunks       |
| 3. Handset or Headset   | 9. BRI stations     |
| 4. BRI Interface card   | 10. Interworking    |
| 5. 2B + D   | 11. DMI             |
| 6. TN556 (ISDN-BRI Line, 4-wire S/T-NT, interface circuit pack) | 12. Switch features |

**Figure 6-2. ISDN—BRI PC interface configuration (Group 2)**

PC Interface users have multiple appearances (depending on the software application used) for their assigned extension. Designate one or more of these appearances for use with data calls. With the ISDN-BRI version, you can use up to 4 separate PC/ISDN Interface cards on the same PC. Assign each card a separate extension, and assign each extension one or more appearances. The availability of specific features depends on the COS of the extension and the COS for the switch. Modem Pooling is provided to ensure general availability of off-net data-calling services.

## Security

---

There are two areas where unauthorized use may occur with this feature: unauthorized local use and remote access.

### SECURITY ALERT:

*Unauthorized local use involves unauthorized users who attempt to make calls from a PC. The PC software has a security setting so users can place the PC in Security Mode when it is unattended. You can also assign Automatic Security so that the administration program on the PC is always active and runs in Security Mode. This mode is password-protected.*

### SECURITY ALERT:

*Remote access involves remote access to the PC over a data extension. Remote users can delete or copy PC files with this feature. You can password-protect this feature. Consult the BCS Product Security Handbook for additional steps to secure your system and to find out about obtaining information regularly about security developments.*

## Considerations

---

- Use the Function Key Module of the 7405D with PC Interface.
- BRI terminals normally are initializing terminals and require you to assign an SPID. The PC/ISDN Platform (Group 2), in a stand-alone configuration, is a noninitializing BRI terminal and does not require you to assign a SPID.
  - Set a locally-defined terminal type with General Terminal Administration
  - Define the terminal type as a noninitializing terminal that does not support Management Information Messages (MIM).
  - Assign the PC/ISDN Platform with an associated (initializing) ISDN-BRI voice terminal (such as an ISDN 7505) using a SPID.
  - Assign the station (using a locally-defined terminal type) to take full advantage of the capabilities of the PC Interface. This terminal type is also noninitializing with no support of MIMs.
- Do not use voice terminals with data modules with the PC Interface. (You can still use 3270 Data Modules if you also use 3270 emulation). If you attach a DCP data module or ISDN data module to a voice terminal that is connected to a PC Interface card, the data module is bypassed (not used). All the interface functions are performed by the interface card even if a data module is present.
- The 7404D voice terminal with messaging cartridge cannot be used with PC Interface. However, the 7404D with PC cartridge can be used, but only with Group 1 configurations.

## Interactions

---

- Data Communications Access

PC Interface uses a digital interface and is not directly compatible with Data Communications Access, which uses an analog interface. Apply Modem Pooling conversion if you use these features together.
- Data Protection

Assign Data Protection—Permanent for use with PC Interface for data communications.
- Host Computer Access

Both PC Interface and Host Computer Access use digital interfaces. These features are compatible and Modem Pooling conversion is unnecessary.
- ISDN-BRI

Each card can have its own separate voice terminal or voice-calling device. A voice terminal does not require special application software on the PC. However, a handset or headset alone requires special application software.
- Modem Pooling

Use Modem Pooling if you use PC Interface to place calls to, or receive calls from, off-premises stations over analog trunks.

# **Data Module Administration**

## Data Modules — general

---

A Data Module is a connection device between a basic-rate interface (BRI) or digital-communications protocol (DCP) interface of the switch and data-terminal equipment (DTE) or data-communications equipment (DCE).

The following types of data modules can be used with the system:

- Announcement data module
- Data line data module
- Processor/trunk data module (P/TDM)
- Netcon data module (R5vs and R5si and later configurations only)
- Processor interface data module (R5vs and R5si and later configurations only)
- System port data module (R5r and later configurations only)
- X.25 data module (R5r and later configurations only)
- 7500 data module
- World Class BRI data module

### Administration Commands

---

You assign each data module to your system by administering a Data Module form. Each Data Module form requires you to specify the type of data module in the `TYPE` field; this is how you distinguish between the many different types of data modules. Use the following commands to access the appropriate Data Module form.

**Table 6-1. Administration commands**

| Action    | Object      | Qualifier <sup>1</sup>                                   |
|-----------|-------------|--|
| add       | data-module | xxxx (extension or 'next')                               |
| change    | data-module | xxxx (extension number)                                  |
| display   | data-module | xxxx (extension number) [print or schedule]              |
| duplicate | data-module | xxxx (extension number to be duplicated)                 |
| list      | data-module | (starting ext number) xxxx ('count') [print or schedule] |
| remove    | data-module | xxxx (extension number)                                  |

---

1. Brackets [ ] indicate the qualifier is optional.

---

**⇒ NOTE:**

The 51X series Business Communications Terminals (BCTs) are not administered on the Data Module form. The 510 BCT (equivalent to a 7405D with a display and built-in DTDM), 515 BCT (equivalent to a 7403D integrated with 7405D display module function, data terminal and built-in DTDM), and the 7505D, 7506D, and 7507D have a DCP interface but have built-in data module functionality. Both are administered through the Station form.

**⇒ NOTE:**

To administer a data module with a 7400D-series voice terminal, refer to the 7400D voice terminal information provided earlier in this book.

## Detailed description of data modules

---

TTI allows data modules without hardware translation to merge with an appropriate data module connected to an unadministered port. The unadministered port is given TTI default translation sufficient to allow a terminal connected to the data module (connected to the port) to request a TTI merge with the extension of a data module administered without hardware translation.

**⇒ NOTE:**

TTI is not useful for Announcement and X.25 hardware.

Administration Without Hardware Translation supports PDM, TDM, Data-Line, Announcement, and X.25 data modules.

**⇒ NOTE:**

The 513 BCT has an EIA interface rather than a DCP interface (no built in data module, attachable telephone, or telephone features). The 513 BCT is not administered; only the data module to which the 513 BCT is connected is administered.

### 7400A/7400B+7400B+ Data Module

Use the 7400A data module instead of an MTDM when you support combined Modem Pooling. The 7400A data module supports asynchronous operation at speeds up to 19200-bps, and provides a DCP interface to the switch and an EIA 232C interface to the associated modem. The 7400A operates in stand-alone mode as a data module.

7400B+ and 8400B+ data modules support asynchronous-data communications and operate in stand-alone mode for data-only service or in linked mode, which provides simultaneous voice and data service. The 7400B+ and 8400B+ provide voice and data communications to 7400D series voice terminals and 602A1 CALLMASTER voice terminals that have a connection to a data terminal or personal computer. The data modules integrate data and voice into the DCP protocol required to interface with the switch via a port on a digital-line circuit

pack. Use the 7400B+ or 8400B+ instead of an MPDM when you need asynchronous operation at speeds up to 19.2-kbps to provide a DCP interface to the switch for data terminals and printers. The 7400B+ and 8400B+ do not support synchronous operation and keyboard dialing.

## **7400D**

This data module supports synchronous operation with AUDIX, CMS, and DCS. It provides synchronous data transmissions at speeds of 19.2-Kbps full duplex.

## **7400C High Speed Link**

The 7400C high-speed link (HSL) is a data-service unit that allows access to DCP data services. It provides synchronous data transmission at speeds of 56- and 64-Kbps and provides a link to high-speed data networks. Used for Group 4 fax applications that include electronic mail and messaging, and electronic storage of printed documents and graphics. Use the 7400C for video teleconferencing and LAN interconnect applications.

## **7500 Data Modules**

The 7500 Data Module connects data-terminal equipment (DTE) or data-communications equipment (DCE) to the ISDN network. The 7500 Data Module supports EIA 232C and V.35 interfaces and RS-366 automatic-calling unit interface (for the EIA 232C interface only).

The 7500 has no voice functions. Configure in the following ways:

- Asynchronous DCE  
300, 1200, 2400, 4800, 9600, 19200-bps
- Synchronous DCE  
1200, 2400, 4800, 9600, 19200, 56000, 64000-bps
- Asynchronous DTE (used for modem pooling)  
up to 19200-bps

The 7500 Data Module is stand-alone or in a multiple-mount housing.



## Asynchronous Data Module

 **NOTE:**

The alias station command cannot be used to alias data modules.

Use the Asynchronous Data Module (ADM) with asynchronous DTEs as a data stand for the 7500 Series of ISDN-BRI voice terminals, thus providing connection to the ISDN network. The ADM provides integrated voice and data on the same voice terminal and supports data rates of 300, 1200, 2400, 4800, 9600, and 19200-bps. This module also supports the Hayes command set, providing compatibility with PC communications packages.

## Data module form field description

The following section provides descriptions of standard fields on Data Module forms. Some of the fields are used for specific data module types; others are used for all data modules. Unique fields and fields requiring special consideration are listed with the appropriate data module descriptions later in this book.

The standard fields are organized alphabetically for easy access.

- **ABBREVIATED DIALING List1** — Enter **p** (personal), **s** (system), **g** (group), or **e** (enhanced). If you enter **p** or **g**, you also must enter a personal list number or a group number, respectively. Entry in this field supports Data Hot Line. This field can be left blank.
- **BCC** — (Bearer Capability Class) Displays when `ISDN-PRI` or `ISDN-BRI Trunks` is enabled on the System-Parameters Customer-Options form. It is a display-only field. The value in the field corresponds to the speed setting of the data module. A BCC of "1" relates to 56-kbps, BCC values of 2, 3, and 4 relate to 64 kbps. This field may be compared with the BCC value in an associated routing pattern when attempted calls utilizing the data module fail to complete. The BCC values must be the same.

See "Generalized Route Selection" in this book for a detailed description of Bearer Capability Classes (BCC) and their ability to provide specialized routing for various types of voice and data calls. The BCC value is used to determine compatibility when non-ISDN-PRI facilities are connected to ISDN facilities (ISDN-PRI Interworking).

- **Board** — Enter the five character announcement board number that identifies the physical board to which the announcement module is connected. If you are using Administration Without Hardware, enter **X** in this field to indicate that there is no hardware associated with this port assignment. Default is blank.

The five character announcement board number is comprised of:

| Characters | Meaning        | Value   |
|------------|----------------|---|
| 1-2        | Cabinet Number | 01 through 44 (R5r and later configurations)  |
|            |                | 01 through 03 (R5si and later configurations) |
|            |                | 01 (R5vs and later configurations)            |
| 3          | Carrier        | A through E                                   |
| 4-5        | Slot Number    | 01 through 20                                 |

- **COR** — Enter a Class of Restriction (COR) number (**0** through **95**) to select the desired restriction; default is **1**.

- **COS** — Enter the desired Class of Service (COS) number (**0** through **15**) to select allowed features; default is **1**.
- **Data Extension** — Enter the extension assigned to the data module. A data extension can be a 1- to 5-digit number and must agree with the Dial Plan.
- **Default Dialing Abbreviated Dialing Dial Code** — Only displays when the Special Dialing Option is set to default. Enter a list number (**0** through **999**) associated with the AD list. When the user goes off-hook and enters a carriage return following the DIAL prompt, the system dials the AD number. The data call originator can also perform data-terminal dialing by specifying a dial string that may or may not contain alphanumeric names. Default is blank.
- **Ext and Name** — Make no entry. This is the extension number and name of the user (previously administered) with associated Data Extension buttons who shares the module.
- **HOT LINE DESTINATION — Abbreviated Dialing Dial Code** — Displays only when `Special Dialing Option` is **hot-line**. Enter a list number (associated with the AD List) from **0** to **999**. When the user goes off-hook on a Data Hot Line call, the system dials the AD number. Entry in this field supports Data Hot Line.
- **ITC (Information Transfer Capability)** — Only displays when `Comm Type` is **56k-data** or **64k-data**. Enter **restricted** (default) or **unrestricted** to indicate the type of transmission facilities to be used for ISDN calls originated from this endpoint. The field does not display for voice-only or BRI stations.
  - If you set ITC to **restricted**, either restricted or unrestricted transmission facilities are used to complete the call. A restricted facility is a transmission facility that enforces 1's density digital transmission (that is, a sequence of 8 digital zeros are converted to a sequence of 7 zeros and a digital 1).
  - If you set ITC to **unrestricted**, only unrestricted transmission facilities are used to complete the call. An unrestricted facility is a transmission facility that does not enforce 1's density digital transmission (that is, digital information is sent exactly as is).
- **MM Complex Voice Ext:** (display only) — This field contains the number of the associated voice terminal in the multimedia complex. This field only displays after you set `Multimedia` to **y**. This field is left blank until you enter the data module extension in MM Complex Data Ext on the Station form. Once you complete the field on the station form, these two extensions are associated as two parts of a one-number complex, which is the extension of the voice terminal. Valid values conform to your dial plan.
- **Multimedia** — Enter **y** to make this data module part of a multimedia complex. This field only appears if **MM** on the System-Parameters Customer Options form is **y**.

- **Name** — Enter the name of the user associated with the data module. The name is optional and can be blank.
- **Port** — Enter 7 characters to specify a port location to which the data module is connected as follows:

| Characters | Meaning        | Value  |
|------------|----------------|--|
| 1-2        | Cabinet Number | 01 through 44 (R5r and later configurations)<br>01 through 03 (R5si and later configurations)<br>01 (R5vs) |
| 3          | Carrier        | A through E  |
| 4-5        | Slot Number    | 01 through 20  |
| 6-7        | Circuit Number | 01 through 04 (x.25 circuit pack)<br>01 through 32 (R5si and later configurations)                         |

 **NOTE:**

You can enter X in the `Port` field to indicate that there is no hardware associated with the port assignment (Administration Without Hardware). These stations are referred to as “phantom stations.” If this data module is designated as a secondary data module (Secondary data module set to y) X cannot be entered into this field. The Port of a primary data module cannot be changed to X if a secondary data module is administered.

- **SPECIAL DIALING OPTION** — Enter **hot-line**, **default**, or leave blank for regular (normal) keyboard dialing. This field identifies the type of dialing for calls when this data module originates calls.
- **TN** — Enter the Tenant Partition number. Default is 1.

## Announcement Data Module

The TN750 Announcement circuit pack has a built-in data module that is administered using the Announcement Data Module form. This data module (in conjunction with an administered Netcon Data Module in R5vs and R5si and later configurations) allows the system to save the recorded announcements file from the TN750 announcement circuit pack to the system tape/disk/memory card (depending on system configuration) and restore from the system tape/disk/memory card to the announcement circuit pack. Only one TN750A or TN750B board can be automatically restored during a system reload. TN750C is not automatically restored during a system reload.

The TN750C board contains flash memory which provides internal backup of announcements on the boards. Thus, the TN750C board does not need the Save and Restore processes still available for the TN750 and TN750B boards. However, you can use the Save and Restore processes to copy announcements between TN750B/C boards.

### NOTE:

Announcements are not saved when a save translations command is executed. Execute the save announcements command to save announcements. This operation does not save announcements on external announcement units connected to AUX or Analog line circuit packs.

## Form instructions

To administer an Announcement Data Module, complete the standard as well as the following unique Data Module form fields.

- **Type** — Enter “announcement”.

```
add data-module next                                Page 1 of 1
                                                    DATA MODULE

Data Extension: 30                                Name:
Type: announcement                                COS: 1                                BCC:
Port: _____                                COR: 1                                Remote Loop-Around Test? n
ITC: restricted__                                TN: 1                                Secondary data module? n
                                                    Connected to: dte

ABBREVIATED DIALING
List1:

SPECIAL DIALING OPTION:

ASSIGNED MEMBER ( Station with a data extension button for this data module )

Ext      Name
1: 1002  27 character  station name
```

Screen 6-1. Recorded Announcement Data Module form (Page 1 of 1)

## Data Line Data Module

---

The Data Line Data Module (DLDM) form assigns ports on the TN726 Data Line circuit pack (DLC) that allows EIA 232C devices to connect to the system. The DLC, with a companion Asynchronous Data Unit (ADU), provides a less expensive data interface to the system than data modules such as Digital Terminal Data Modules (DTDMs), Modular Processor Data Modules (MPDMs), Modular Trunk Data Modules (MTDMs), or other asynchronous DCP data modules.

The DLC supports asynchronous transmissions at speeds of Low and 300, 1200, 2400, 4800, 9600, and 19200 bps over 2-pair (full-duplex) lines. These lines can have different lengths, depending on the transmission speed and wire gauge.

The DLC has 8 ports. The connection from the port to the EIA device is *direct*, meaning that no multiplexing is involved. A single port of the DLC is equivalent in functionality to a data module and a digital line port. The DLC appears as a data module to the Digital Terminal Equipment (DTE) and as a digital line port to the switch.

The DLC connects the following EIA 232C equipment to the system:

- Printers
- Non-Intelligent Data Terminals
- Intelligent Terminals, Personal Computers (PCs)
- Host Computers
- Information Systems Network (ISN), RS-232C Local Area Networks (LANs), or other data switches.

### Form instructions

---

To administer a Data Line Data Module, complete the standard as well as the following unique Data Module form fields.

6 Data Module Administration  
Data Line Data Module

```

                                     DATA MODULE
                                     Page 1 of 2

Data Extension: 30      Name: 27      BCC:
  Type: data-line___   COS: 1
  Port: _____    COR: 1
  ITC: restricted___   TN: 1      Connected to: dte

ABBREVIATED DIALING
List1:

SPECIAL DIALING OPTION:

ASSIGNED MEMBER (Station with a data extension button for this data module)

      Ext      Name
1: 1002      27 character      station name
```

Screen 6-2. Data Line Data Module form (Page 1 of 2)

```

                                     DATA MODULE
                                     Page 2 of 2

CAPABILITIES
      KYBD Dialing? y      Configuration? n
      Busy Out? n

SPEEDS
      Low? y      1200? y      4800? y      19200? y
      300? y      2400? y      9600? y      Autoadjust? n

OPTIONS
      Permit Mismatch? n      Dial Echoing? y
      Disconnect Sequence: two-breaks      Answer Text? y
      Parity: even      Connected Indication? y
```

Screen 6-3. Data Line Data Module form (Page 2 of 2) — if KYBD Dialing set to y

|              |                    |             |             |
|--------------|--------------------|-------------|-------------|
|              |                    | DATA MODULE | Page 2 of 2 |
| CAPABILITIES |                    |             |             |
|              | KYBD Dialing? n    |             |             |
|              | Busy Out? n        |             |             |
| SPEEDS       |                    |             |             |
| Low? y       | 1200? y            | 4800? y     | 19200? y    |
| 300? y       | 2400? y            | 9600? y     |             |
| OPTIONS      |                    |             |             |
|              | Permit Mismatch? n |             |             |

Screen 6-4. Data Line Data Module form (Page 2 of 2) — if KYBD Dialing set to n)

- **Type** — Enter “**data-line**”.
- **Connected To** — Enter **dte** (Data Terminal Equipment) or **isn** (Information Systems Network). This field shows to what the ADU (Asynchronous Data Unit) is connected. Default is **dte**.

Page 2 of the form

See “DLC Option Settings” following these instructions for additional information when assigning entries for the remaining fields on the form.

- **KYBD Dialing** — Enter **y** to allow keyboard dialing. This enables the data endpoint to receive and transmit text during call origination or termination. If you enter **y**, Low must be set to **n**.

This option must be enabled to allow data endpoints to originate calls via the EIA 232C interface and obtain ASCII feedback text. When enabled, the user gets the dial prompt. This option normally is enabled for “originate/receive” DTE that has a need to set up data calls. If this option is disabled, originations cannot be done at the DTE and text feedback does not occur at the DTE during call setup/take down. Data call answering is still allowed but without text feedback.

 **NOTE:**

ADU-type hunt groups connecting the system to terminal servers on a host computer should have these hunt group extensions assigned as “no” keyboard dialing.

- **Configuration** — Displays when KYBD Dialing is enabled. Enter **y** to allow the viewing and changing of options from the DTE.

This option normally is enabled for “originate/receive” DTE such as non-intelligent terminals and disabled for intelligent devices such as computers. Keyboard dialing must be enabled with this option.



- **Busy Out** — Enter **y** to place the DLC port in a busied-out state once the DTE control lead to the DLC is dropped. This option should be enabled for DTEs that are members of a hunt group and to allow “busy out” when DTE turns power off so that calls do not terminate on that DTE.
- **SPEEDS** — Enter **y** to select operating speeds as follows:
  - **Low** — Enter **y** to instruct the DLC to operate at a low speed from 0 to 1800 bits per second (bps). Enter **n** if **y** is entered in the `Keyboard Dialing` field.
  - **300, 1200, 2400, 4800, 9600, or 19200** — Enter **y** beside the desired operating speed. Enter **n** if the speed is not desired. The DLC can be any one of these speeds. The speed is matched for the duration of the call, from call setup to call takedown.

When multiple speeds are selected (select three or more, do not select just two speeds) and autoadjust is disabled, the DTE's speed must be the highest selected speed. This is required because all feedback text is delivered to the DTE at the highest selected speed.
  - **Autoadjust** — Displays when `KYBD Dialing` is enabled. Enter **y** which tells the DLC port to automatically adjust to the operating speed and parity of the DTE it is connected to. Enter **n** if this option is not desired. Autoadjust can be selected with any of the speeds selected in the previous step. Autoadjust allows the DLC port to determine the speed and parity of the DTE and then match itself to this speed. Autoadjust only applies to calls originated by the user through Keyboard Dialing.
- **Permit Mismatch** — Enter **y** to instruct the DLC to operate at the highest selected speed, which is a higher rate than the far-end data module. Enter **n** if this option is not desired.

This option allows the EIA interface to operate at a rate different than that agreed to in the data module handshake. (The data module handshake is always the highest compatible rate as determined by the reported speed option of each data module.) Permit Mismatch eliminates the need to change the DTE/DLC speed every time a call is placed to/from an endpoint operating at a different speed. When this option is enabled, the DLC reports the highest optioned speed and all the lower speeds (or the previously selected autoadjust speed) during the handshake process.

 **CAUTION:**

*Caution must be used when using this option to send information from a DTE/DCE that is transmitting data at higher rates than that of the far end. Sustained usage of this type transmission results in loss of data. Whenever this option is enabled, the DTE must match the highest speed selected for the associated DLC port.*

This option is intended to be used by a DTE device operating locally at a higher baud rate than that of its far-end connection but transmitting relatively low amounts of data (for example, a user typing at a terminal). Also, this option may be selected whether or not Keyboard Dialing is selected.



**NOTE:**

The Low speed setting is not reported as an available speed when `Permit Mismatch` is enabled.

- **Dial Echoing** — Displays when `KYBD Dialing` is enabled. Enter **y** to echo characters back to the DTE. Dial echoing should be disabled when keyboard dialing is done by an intelligent device.
- **Disconnect Sequence** — Displays when `KYBD Dialing` is enabled. Enter **long-break** or **two-breaks** to select the sequence for a disconnect. A long-break is greater than 2 seconds and two-breaks is within 1 second.
- **Answer Text** — Displays when `KYBD Dialing` is enabled. Enter **y** to allow text messages to be delivered to the DTE when a call is being answered. Enter **n** if this option is not desired.

This option enables text feedback that is normally delivered to the DTE when a call is answered or disconnected. The Answer Text option applies to DLC-generated text as well as text received from the system. If this option is disabled, the system still generates the text, but the DLC prevents it from being sent to the device.

This applies to the following messages:

- INCOMING CALL
- ANSWERED
- DISCONNECTED
- DISCONNECTED OTHER END

This option is usually disabled when the answering DTE is a computer or an intelligent device.

- **Parity** — Displays when `KYBD Dialing` is enabled. Enter **even**, **odd**, **mark**, or **space** to select the desired type of parity. The DLC generates the parities (even, odd, mark, and space) when call setup text is sent to the DTE. The DLC does not check the parity when receiving dialing characters. Parity has nothing to do with the far end; it is used by the DLC to terminal communications during call setup.
- **Connected Indication** — Displays when `KYBD Dialing` is enabled. Enter **y** to give text feedback to the DTE when a connection has been established. This option generates a "CONNECTED" message to the DTE when the connection has been established. If `KYBD Dialing` is not selected, the connected indication is provided by the DLC activating its EIA 232C control lead.

## DLC Option Settings

The following provides additional information on the option settings for DLCs when used with the following types of devices:

- Printers
- Non-intelligent terminals
- Data terminals and personal computers
- Host computers
- Information Systems Network (ISN)

### Printers

A DLC port, attached to a printer, usually terminates a data call. Therefore, in this connection, the printer is the endpoint device. The originating device may be attached to a DCP mode 2 data module (such as the MPDM) or the DLC. A Z3A ADU extends the range of the EIA 232C connection.

When a receive-only printer (or any printer that does not generate the Transmit Data and DTR leads) is used, the ADU must be powered from a small plug-mounted transformer (2012D, or equivalent) connected to pins 7 and 8 of the modular jack. (See *ADU User Manual* for details.)

An ADU cannot be used if the printer has hardware flow control using the Clear To Send (CTS) lead. An ADU can be used, however, if the printer is using software flow control.

A printer connected to a DLC is usually assigned as a line. [Table 6-2](#) lists the option settings for printer connections.

**Table 6-2. DLDM form settings for printer connection**

| Field on form   | Option                                      | Comments   |
|-----------------|---|--|
| Speed           | Highest speed at which the Printer operates | Subject to distance limitations; Autoadjust not used |
| KYBD Dialing    | no  |  |
| Busy Out        | yes   | If printer is member of Hunt Group                   |
| Permit Mismatch | yes   | No, if printer is low speed                          |
| Parity          | -   | Don't care   |
| Dial Echoing    | -   | Don't care   |

*Continued on next page*

**Table 6-2. DLDM form settings for printer connection — Continued**

| Field on form        | Option | Comments   |
|----------------------|--------|------------|
| Disconnect Sequence  | -      | Don't care |
| Answer Text          | -      | Don't care |
| Connected Indication | -      | Don't care |
| Configuration        | no     |            |

### Non-intelligent terminals

A non-intelligent terminal connected to the DLC usually is assigned as a line. [Table 6-3](#) lists the option settings for non-intelligent terminals.

**Table 6-3. DLDM form settings for connection to non-intelligent terminals**

| Field On form        | Option   | Comments   |
|----------------------|--|--|
| Speed                | All speeds at which the terminal can operate; autoadjust | Subject to distance limitations; Autoadjust when Keyboard Dialing is "y" and the Terminal can generate an ASCII "return" |
| KYBD Dialing         | yes  |  |
| Busy Out             | no   | Yes, if terminal is member of a hunt group   |
| Permit Mismatch      | yes  | -  |
| Parity               | Same as DTE  |  |
| Dial Echoing         | yes  | Only if KYBD Dialing is yes  |
| Disconnect Sequence  | 2 <BREAK>s   | Depends on terminal  |
| Answer Text          | yes  |  |
| Connected Indication | -  | Don't care   |
| Configuration        | yes  |  |

## Data terminals and personal computers

An intelligent data terminal or a personal computer (PC) attached to a DLC can either originate or terminate a data call. A single ADU at the site of the originating device extends the distance signals can travel to the switch (the model ADU depends on the terminal connector). An analog telephone can be attached to this arrangement whenever an ADU uses the standard building wiring. [Table 6-4](#) lists the option settings used for data terminal and personal computer connections.

**Table 6-4. DLDM form settings for connection to data terminal or personal computer**

| Field on form        | Option  | Comments  |
|----------------------|---|---|
| Speed                | All speeds at which the Data Terminal or PC can operate | Subject to distance limitations; Autoadjust not used                  |
| KYBD Dialing         | yes   |   |
| Busy Out             | no  | Yes, if device is accessed through a hunt group                       |
| Permit Mismatch      | yes   | No, if device does not support XON/XOFF flow control                  |
| Parity               | Same as DTE   |   |
| Dial Echoing         | no  | These devices can dial in the ASCII stream without human intervention |
| Disconnect Sequence  | Long <BREAK>  | -   |
| Answer Text          | no  | These devices may not want to see any text                            |
| Connected Indication | -   | Don't care  |
| Configuration        | yes   |   |

## Host computers

A host computer may originate and terminate a data call. For this application, the number of DLCs required depends on the number of ports needed. An MADU can be used (instead of eight ADUs) to complete the connection. [Table 6-5](#) lists option settings for a port that has a terminating connection to a host computer. [Table 6-5](#) shows the option settings for a port that has an originating connection from a host computer.



**NOTE:**

If `Keyboard Dialing` is disabled, the rest of the option settings are irrelevant.

**Table 6-5. DLDM form settings for terminating connection to host computer**

| Field on form        | Option                                       | Comments   |
|----------------------|--|--|
| Speed                | All speeds at which the computer can operate | Subject to distance limitations; Autoadjust not used |
| KYBD Dialing         | no   |  |
| Busy Out             | -  | Don't care   |
| Permit Mismatch      | -  | Don't care   |
| Parity               | -  | Don't care   |
| Dial Echoing         | -  | Don't care   |
| Disconnect Sequence  | -  | Don't care   |
| Answer Text          | -  | Don't care   |
| Connected Indication | -  | Don't care   |
| Configuration        | -  | Don't care   |

## **Processor/Trunk Data Module**

---

These forms assign Modular Processor Data Modules (MPDMs) and Modular Trunk Data Modules (MTDMs). One form is required for assigning MPDMs (700D), 7400B, 7400D or 8400B Data Module, and another form for MTDMs (700B, 700C, 700E, 7400A). One form must be completed for each MPDM, 7400B, 7400D, 8400B or MTDM.

The MPDM or 7400B Data Module provides a Data Communications Equipment (DCE) interface for connection to equipment such as data terminals, CDR output devices, on-premises administration terminal, Message Server, Property Management System (PMS), AUDIX, and host computers. It also provides a Digital Communications Protocol (DCP) interface to the digital switch. (DCE is the equipment on the network side of a communications link that provides all the functions required to make the binary serial data from the source or transmitter compatible with the communications channel.)

The MTDM provides an Electronic Industries Association (EIA) Data Terminal Equipment (DTE) interface for connection to off-premises private line trunk facilities or a switched telecommunications network and a DCP interface for connection to the digital switch. (DTE is the equipment comprising the endpoints in a connection over a data circuit. For example, in a connection between a data terminal and a host computer, the terminal, the host, and their associated modems or data modules make up the DTE.) The MTDM or 7400A Data Module can also serve as part of a conversion resource for Combined Modem Pooling.

## Form instructions

```

                                     Page 1 of 1
                                DATA MODULE

Data Extension: 30                Name: 27                BCC:
      Type: pdm_____          COS: 1                Remote Loop-Around Test? n
      Port: _____          COR: 1                Secondary data module? n
      ITC: restricted__        TN: 1                Connected to: dte

ABBREVIATED DIALING
List1:

SPECIAL DIALING OPTION:

ASSIGNED MEMBER (Station with a data extension button for this data module)

      Ext      Name
1: 1002      27 character      station name
    
```

### Screen 6-5. MPDM/MTDM Data Module form (Page 1 of 1)

To administer a MPDM or MTDM, complete the standard as well as the following unique Data Module form fields.

- **Type** — Enter **pdm** (default) when assigning a DCE interface or **tdm** when assigning a DTE interface.
- **Connected To** — Only displays when **Type** is **pdm**. Enter **dte** if the data module is connected to Data Terminal Equipment (DTE) or enter **isn** if connected to an Information Systems Network (ISN).
- **Remote Loop-Around Test** — Enter **y** if the data module supports a loop-back test at the EIA interface. In general, Lucent Technologies equipment supports this test but it is not required by Level 2 Digital Communications Protocol.
- **Secondary data module** — Only displays when **Type** is **pdm**. Enter **y** if this PDM is the secondary data module used for Dual I-channel AUDIX networking. Enter **n** if this is the primary PDM, or if this data module is not used for AUDIX networking. The primary data module must be administered before the secondary data module may be added. If **Port** is **X**, **Secondary data module** cannot be **y**.



## Netcon Data Module

Netcon data modules are the Processor Data Modules (PDMs) that are integrated into the system's network control ports that provide asynchronous circuit switched interfaces to the maintenance and administration terminals, Hospitality journal printers, and CDR digital output. They are characterized by their special locations, that is, special port identifications.

**⇒ NOTE:**

The Netcon data module is only applicable to R5vs and R5si and later configurations. For R5r and later configurations, see "[System Port Data Module](#)" on page 6-248.

### Form instructions

Page 1 of 1

DATA MODULE

Data Extension:                    BCC: \_\_\_  
 Type: netcon                      COS: 1                    Maintenance Extension: \_\_\_\_  
 Physical Channel: \_\_\_            COR: 1  
 Name: \_\_\_\_\_                TN: 1  
 ITC: restricted

ABBREVIATED DIALING  
 List1: \_\_\_\_\_

SPECIAL DIALING OPTION: \_\_\_\_\_  
 HOT LINE DESTINATION  
     Abbreviated Dialing Dial Code (From above list): \_  
 ASSIGNED MEMBER (Station with a data extension button for this data module)

| Ext | Name |
|-----|------|
| 1:  |      |

Screen 6-6. Netcon Data Module form (Page 1 of 1)

To administer a Netcon Data Module, complete the standard as well as the following unique Data Module form fields.

- **Type** — Enter **netcon**.
- **Physical Channel** — Enter a netcon data channel number from **01** through **04**.
- **Maintenance Extension** — Enter the extension number required to perform maintenance functions on the standby netcon physical channel in a duplicated system. The standby remote loop around tests fails if this field is not administered.

## Processor Interface Data Module

---

The Processor Interface data modules are the Processor Data Modules (PDMs) that are integrated into the system's synchronous/asynchronous Processor Interface circuit pack ports.

 **NOTE:**

The Processor Interface data module is applicable only to R5vs and R5si and later configurations.

They are used to provide the following interfaces:

- 3B/Call Management System (maximum of one)
- 3B/Message Server (maximum of one)
- Distributed Communications System (maximum of eight)
- AUDIX (maximum of one)
- ISDN-PRI (maximum of eight)

 **NOTE:**

Not all maximums can be achieved at the same time

Connections for these interfaces are achieved via a digital line port and MPDM combination, and/or in the case of DCS or ISDN-PRI, via a DS1 interface. One direct EIA connection is available (labeled as Processor Interface on the back of the Control Cabinet) for simplex operation. When used, the physical channel assignment (see below) must be "01". Use of the EIA connection eliminates the need for one digital line port/MPDM combination.

## Form instructions

---

Page 1 of 1

DATA MODULE

Data Extension:  
Type: procr-infc      COS: 1      Maintenance Extension: \_\_\_\_\_  
Physical Channel: \_\_\_\_\_      COR: 1  
Name: \_\_\_\_\_      TN: 1

ABBREVIATED DIALING  
List1: \_\_\_\_\_

SPECIAL DIALING OPTION: \_\_\_\_\_  
HOT LINE DESTINATION  
Abbreviated Dialing Dial Code (From above list): \_  
ASSIGNED MEMBER ( Station with a data extension button for this data module )

| Ext | Name |
|-----|------|
| 1:  |      |

### Screen 6-7. Processor Interface Data Module form (Page 1 of 1)

To administer a Processor Interface Data Module, complete the standard as well as the following unique Data Module form fields.

- **Type** — Enter **procr-infc**.
- **Maintenance Extension** — Enter the extension number required to perform maintenance functions on the standby physical channel in a duplicated system. The standby remote loop around tests fail if this field is not administered.
- **Physical Channel** — Enter the 2-digit circuit number of the Processor Interface port. A multi-carrier cabinet system supports the use of two Processor Interface circuit packs, the first circuit pack (mounted in Control Carrier A) supports physical channels or links 01 through 04; the second (mounted in Control Carrier A) supports physical channels or links 05 through 08. A single-carrier cabinet system supports one Processor Interface circuit pack and physical channels or links 01 through 04 only. The Physical Channel number is referred to on associated system forms as the Interface Link number.

## System Port Data Module

```
DATA MODULE Page 1 of 4

Data Extension: _____ BCC: 2
Type: system-port_ COS: 1
Port: __ COR: 1
Name: _____ TN: 1
PDATA Port: _____

ASSIGNED MEMBER ( Station with a data extension button for this data module )

Ext      Name
1: _____
```

Screen 6-8. System Port Data Module form (Page 1 of 4)

To administer a System Port Data Module, complete the standard as well as the following unique Data Module form fields.

- **Type** — Enter **system-port**.
- **PDATA Port** — Used to relate the physical PDATA port to which the mode 3 portion of the system port is connected. Enter a seven alphanumeric-digit port location to which the data module is connected where the first two characters identify the cabinet number (**01** to **22**); the third character identifies the carrier (**A** through **E**); the fourth and fifth characters identify the slot number in the carrier (**01** to **20**); the last two characters identify the circuit number (**01** to **12**). This entry must be assigned to a port on a PDATA Line Board.

## X.25 Data Module

These forms assign BX.25 Data Modules in R5r and later configurations for communications to Adjuncts and other nodes in a DCS network. Each one of these data modules must correspond to an entry in the Interface Link form.

### Form instructions

To administer a X.25 Data Module, complete the standard as well as the following unique Data Module form fields.

### Page 1 of the form

DATA MODULE Page 1 of 2

|                              |              |                                 |
|------------------------------|--------------|---------------------------------|
| Data Extension: 20000        |              |                                 |
| Type: x.25_____              | COS: 1       | Remote Lop-Around Test? n       |
| Port: 01C0301                | COR: 1       | Baud Rate: 9600                 |
| Name: G2 DCIU LINK 4         | TN: 1        |                                 |
| Endpoint Type: adjunct       | DTE/DTC: dce | Error Logging? y                |
| Permanent Virtual Circuit? y |              | Highest PVC Logical Channel: 64 |
| Switched Virtual Circuit? n  |              |                                 |

Screen 6-9. X.25 Data Module form (Page 1 of 2)

- **Type** — Enter **x.25**.
- **Endpoint Type** — Must be assigned as **adjunct**. An endpoint type is a type of packet switched data endpoint that uses X.25 call control procedures. The X.25 Endpoint connects to external ports on the PGATE board and to the TDM bus via a DS1 trunk. Ports connected to the adjunct endpoint can be either DTEs or DCEs. The type of endpoint (DTE or DCE) is administrable on the “data-mod” form.
- **DTE/DCE** — Specifies how the above endpoint type acts (DTE or DCE). Default is dte.
- **Baud Rate** — The maximum raw data transmission speed (**300, 1200, 2400, 4800, 9600, or 19200**; may also be **switched** if Cable Type on the PGATE form is **none**). Default is blank.
- **Error Logging** — To record X.25 protocol errors in the hardware error log, enter **y**. See the *DEFINITY Enterprise Communications Server Maintenance manual* for more information about error logs.

- **Remote Loop-Around Test** — To allow remote loop-around tests on this port, enter **y**. An **n** aborts a request for this test. See the *DEFINITY Enterprise Communications Server Maintenance manual* for more information about remote loop-around tests.
- **Permanent Virtual Circuit** — Indicates that the logical channels for PVC are allowed for this port; default is **y** (cannot be changed).
- **Switched Virtual Circuit** — Indicates that the Switched Virtual Circuit is not allowed for this port; default is **n** (cannot be changed).
- **Highest PVC Logical Channel** — Indicates that 1 to 64 Logical Channels are allowed on this port. Default is **64** (cannot be changed).

Page 2 of the form

```

                                DATA MODULE
                                Page 2 of 2
LAYER 2 PARAMETERS
    Number of Outstanding Frames (w): 4
        Retry Attempt Counter (N2): 2
            Frame Size (N1): 135
Retransmission (T1) Timer (1/10 seconds): 10
    Idle (T4) Timer (1/10 seconds): 30
LAYER 3 PARAMETERS
    Number of Outstanding Packets: 2
    Restart (T20) Timer (seconds): 8
    Reset (T22) Timer (seconds): 10
    
```

Screen 6-10. Adjunct Data Module form (Page 2 of 2)

- **Number of Outstanding Frames (w)** — Specifies layer 2 window size (**1** to **7** frames). If the value is **2**, up to 2 frames can be sent without confirmation. Default is **4**.
- **Retry Attempt Counter (N2)** — Specifies the number of times (**0** to **7**) to send one frame when this frame is not confirmed for a period of time. Default is **2**.
- **Frame Size (N1)** — Specifies the number of bytes (**135** or **263**) in a frame. Default is **135**. If the value is **135**, there can be up to 1080 bits within a frame. This value is suitable for all adjuncts and for DCS.
- **Retransmission (T1) Timer (1/10 seconds)** — The T1 timer is started at the beginning or the end of the transmission of a frame. At the end of this timer (**0** to **250**), retransmission of a frame is initiated according to the procedures for link set-up and disconnection or information transfer. Default is **10**.

- **Idle (T4) Timer (1/10 seconds)** — The T4 timer is a system parameter that represents the time a DTE allows without frames being exchanged on the data link (0 to 250). Default is 30.
- **Number of Outstanding Packets** — Specifies the number of packets (2 to 7) that can be sent without confirmation. Default is 2.
- **Restart (T20) Timer (seconds)** — The T20 timer is a DTE time-limit (0 to 500) started when DTE issues a restart indication and terminated when the restart request is received or confirmed. Default is 8.
- **Reset (T22) Timer (seconds)** — The T22 timer is a DTE time-limit (0 to 500) started when DTE issues a reset indication and terminated when the reset request is received or confirmed. Default is 10.

## 7500 Data Module

The 7500 data module supports automatic TEI, B-channel, maintenance and management messaging, and SPID initialization capabilities. BRI endpoints, both voice and/or data, are assigned to either the TN556 ISDN-BRI circuit pack or the TN2198 ISDN-BRI circuit pack. Each can support up to 12 ports. Since BRI provides multipoint capability, more than one ISDN endpoint (voice or data) can be administered on one port. For BRI, multipoint administration allows for terminals having SPID initialization capabilities, and can only be allowed if no endpoint administered on the same port is a fixed tie endpoint and no station on the same port has B-channel data capability. Currently, multipoint is restricted to 2 endpoints per port.

### Form instructions

To administer a 7500 Data Module, complete the standard as well as the following unique Data Module form fields.

### Page 1 of the form

Page 1 of 2

DATA MODULE

Data Extension: \_\_\_\_\_ Name: \_\_\_\_\_  
 Type: 7500\_\_\_\_\_ COS: 1\_ Multimedia? y  
 Port: \_\_\_\_\_ COR: 1\_ MM Complex Voice Ext: xxxxx  
 TN: 1\_

ABBREVIATED DIALING  
 List1: \_\_\_\_\_  
 SPECIAL DIALING OPTION: hot-line  
 HOT LINE DESTINATION  
 Abbreviated Dialing Dial Code (From above list): \_

CIRCUIT SWITCHED DATA ATTRIBUTES (used for modem pooling)  
 Default Duplex: full Default Mode: async Default Speed: 1200\_

DATA MODULE CAPABILITIES  
 Default ITC: restricted Default Data Application? M2\_A

### Screen 6-11. 7500 Data Module form (Page 1 of 2)

- **Type** — Enter **7500**.
- **CIRCUIT SWITCHED DATA ATTRIBUTES**



**NOTE:**

These fields represent defaults needed for modem pooling conversion resource insertion when the endpoint does not support data query capability. These fields have no significance for data



modules providing data query [all Lucent Technologies-supported ISDN-BRI data modules (7500 and ADM)]. For Lucent Technologies ISDN-BRI data modules, use the default settings.

- **Default Duplex** — Used to identify the duplex mode. Valid entries are **full** (default) or **half**.
- **Default Mode** — Used to identify the data mode. Valid entries are **sync** (synchronous) or **async** (asynchronous). Default is **async**.
- **Default Speed** — Used to identify the data rate. Valid entries are **1200** (default), **2400**, **4800**, and **19200**. When default mode is **sync**, valid entries also include speeds of **56000** and **64000**.

■ **DATA MODULE CAPABILITIES**

- **Origination Default Data Applications** — Used to identify mode to be used for originating data calls when the mode is not specified with the calling parameters. This mode is also used for terminating trunk calls that do not have bearer capability specified or administered connections. Possible mode values are M0 (mode 0), M1 (mode 1), M2 (mode 2), and M3/2 (mode 3/2 adaptable), or blank. Valid entries are **M0**, **M1**, **M2\_A** (default), **M2\_S**, or **M3/2**.

Page 2 of the form

Page 2 of 2

DATA MODULE

BRI LINK/MAINTENANCE PARAMETERS

|                |               |               |                 |
|----------------|---------------|---------------|-----------------|
| XID? y         | Fixed TEI? n  | TEI: ____     |                 |
| MIM Support? y | Endpt Init? y | SPID: 300____ | MIM Mtce/Mgt? y |

Screen 6-12. 7500 Data Module form (Page 2 of 2)

- **XID** — Used to identify layer 2 XID testing capability. Default is **y**.
- **Fixed TEI** — Used to indicate whether or not the endpoint has Fixed Terminal Equipment Identifier (TEI) capability. TEI identifies a unique access point within a service. For Fixed TEI stations, the TEI must be administered. Terminals with automatic TEI capability, the associated TEI is assigned by the system. Default is **n**.
- **TEI** — Only displays if **Fixed TEI** is **y**. Enter a 1- to 2-digit number in the range of **0** through **63**.
- **MIM Support** — (Management Information Message Support) Used to support two types of capabilities: MIM endpoint initialization capability (SPID support), and other Maintenance/Management capability. Default is **y**.

- **Endpt Init** — Only displays if `MIM Support` is **y**. Used to indicate the terminal's endpoint initialization capability. Endpoint initialization is a procedure, required for multipoint operation, by which User Service Order Profile (USOP) is associated with an endpoint on the ISDN-BRI. This association is made via the Service Profile Identifier (SPID), administered into the system and entered into the ISDN-BRI terminal. For a ISDN-BRI terminal to become operational in a multipoint configuration, both the administered SPID and the SPID programmed into the ISDN-BRI terminal must be the same. This means that the SPID of the new or re-used terminals must be programmed to match the administered SPID value. Default is **y**.
- **SPID** — Only displays if `Endpt Init` is **y**. The Service Profile Identifier (SPID) is a variable parameter of up to ten digits. The SPID must be different for all terminals on the ISDN-BRI and from the Service SPID. The SPID should always be assigned, if the SPID is not assigned for the first ISDN-BRI on a port, any other ISDN-BRI assignment to that port is blocked. Valid entries are numeric strings in the range of **0** through **9999999999**. Default is the station's extension number.
- **MIM Mtce/Mgt** — Only displays if `MIM Support` is **y** (default). Used to indicate if the terminal supports MIM Maintenance and Management capabilities, other than endpoint initialization

## World Class BRI Data Module

### Form instructions

To administer a World Class BRI Data Module, complete the standard as well as the following unique Data Module form fields.

### Page 1 of the form

```

                                                                 Page 1 of 2
                                DATA MODULE

Data Extension:
  Type: 7wcbri_____
  Port: _____
Name: _____
COS: 1_           Multimedia? y
COR: 1_          MM Complex Voice Ext: xxxxxx
TN: 1_

ABBREVIATED DIALING
List1:

SPECIAL DIALING OPTION:

CIRCUIT SWITCHED DATA ATTRIBUTES
Default Duplex: full      Default Mode: async      Default Speed: 1200

DATA MODULE CAPABILITIES
Default ITC: restricted           Default Data Application: M2_A
```

### Screen 6-13. World Class BRI Data Module form (Page 1 of 2)

- **Type** — Enter **wcbri**.
- **CIRCUIT SWITCHED DATA ATTRIBUTES**



#### NOTE:

These fields represent defaults needed for modem pooling conversion resource insertion when the endpoint does not support data query capability (typically a DMI Mode2 BRI endpoint). These fields have no significance for data modules providing data query. For World Class ISDN-BRI data modules, the default settings should be used.

- **Default Duplex** — Used to identify the duplex mode. Valid entries are **full** (default) or **half**.

- **Default Mode** — Used to identify the data mode. Valid entries are **sync** (synchronous) or **async** (asynchronous). Default is **async**.
- **Default Speed** — Used to identify the data rate. Valid entries are **1200** (default), **2400**, **4800**, and **19200**. When default mode is **sync**, valid entries also include speeds of **56000** and **64000**.
- **DATA MODULE CAPABILITIES** — These fields are used when a BRI endpoint is the originator of an administered connection.
  - **Default ITC** — Should be set to **unrestricted** for a WCBRI endpoint used as an administered connection.
  - **Origination Default Data Applications** — Used to identify the mode to be used for originating data calls when the mode is not specified with the calling parameters. This mode is also used for terminating trunk calls that do not have bearer capability specified or administered connections. Possible mode values are M0 (mode 0), M1 (mode 1), and M3/2 (mode 3/2 adaptable,) or blank. Valid entries are **M0**, **M2\_2**, **M2\_S**, or **M3/2**. Default is **M2\_A**. This field should be **M0** (DMI Mode 0) for a WCBRI endpoint used as an administered connection.

Page 2 of the form

Page 2 of 2

DATA MODULE

BRI LINK/MAINTENANCE PARAMETERS

|                         |               |              |                |
|-------------------------|---------------|--------------|----------------|
|                         | XID? n        | Fixed TEI? n | TEI: ____      |
| Country Protocol: 1____ | Endpt Init? y | SPID: _____  | Endpt ID: ____ |

Screen 6-14. World Class Data Module form (Page 2 of 2)

- **XID** — Used to identify layer 2 XID testing capability. Default is **n**.
- **Fixed TEI** — Used to indicate whether or not the endpoint has Fixed Terminal Identification (TEI) capability. TEI is used to identify a unique access point within a service. For Fixed TEI stations, the TEI must be administered. For terminals with automatic TEI capability, the associated TEI is assigned by the system. Default is **n**.
- **TEI** — Only displays if **Fixed TEI** is **y**. Enter a number in the range of **0** through **63**.

- **Country Protocol** — Enter the protocol that corresponds to your supported initialization and codesets. The Country Protocol must match any previously-administered endpoint on the same port. The following table lists the valid protocol entries. Default is 1 (US Bellcore).

| Country/Area                           | Protocol |
|--|----------|
| Australia                              | 2        |
| ETSI (Europe)                          | etsi     |
| Japan                                  | 3        |
| Singapore                              | 6        |
| United States (Bellcore National ISDN) | 1        |

- **Endpt Init** — Displays only if `MIM Support` is **y** and indicates the terminal's endpoint initialization capability. Enter **y** (default) if the terminal supports Bellcore ISDN-1 terminal initialization procedures or enter **n** for all other country protocols.

Endpoint initialization is a procedure, required for multipoint operation, by which User Service Order Profile (USOP) is associated with an endpoint on the ISDN-BRI. This association is made via the SPID, administered into the system, and entered into the ISDN-BRI terminal. For an ISDN-BRI terminal to be operational in a multipoint configuration, both the administered SPID and the SPID programmed into the ISDN-BRI terminal must be the same. Therefore, the SPID of new or reused terminals must be programmed to match the administered SPID value.

- **SPID** — (Service Profile Identifier) This field displays only if `Endpt Init` is **y**. Enter a variable length parameter (up to 10 digits). SPID is a numeric string, which means that the value of 00 is different from 000. The SPID must be different for all terminals on the BRI and from the Service SPID. The SPID should always be assigned. If the SPID is not assigned for the first BRI on a port, any other BRI assignments to that port are blocked. Valid entries are numeric strings in the range of **0** through **9999999999**. Default is the station extension.

 **NOTE:**

If using Administration Without Hardware for an ISDN-BRI extension (Port set to X) and Terminal Translation Initialization (TTI) is intended to be used to assign the port, then the SPID number must equal the station number.

- **Endpt ID** — This field displays only if `Endpt Init` is **y**. Enter a 2-digit number (**00–62**). Each Endpt ID field must have a unique value for each endpoint on the same port.

This field provides for multipoint configuration conformance to the Bellcore Terminal Initialization procedures. In these procedures, a multipoint configuration requires that the last 2 digits of the Service Profile Identifier (SPID) be between 00 and 63 and be binary unique for each endpoint. This field, combined with the SPID, gives the effective SPID administered into the terminal. Bellcore ISDN-1 requires that the SPID programmed into the endpoint contain at least 9 digits. (For example, if `SPID` is **1234**, and `Endpt ID` is set to **01**, then the SPID administered on the terminal is 000123401. The three leading zeros are necessary to create a 9-digit SPID.)

# Trunk Group Administration



---

This section contains the following DEFINITY ECS Trunk Group Administration features. [Trunk Group Administration Forms](#) are located at the end of this chapter.

| <b>Feature</b>   | <b>Page</b>          |
|--|----------------------|
| <a href="#">Automatic Transmission Measurement System</a>      | <a href="#">7-2</a>  |
| <a href="#">DS1 Trunk Service</a>                              | <a href="#">7-11</a> |
| <a href="#">Digital Multiplexed Interface</a>                  | <a href="#">7-19</a> |
| <a href="#">Enhanced ICSU</a>                                  | <a href="#">7-21</a> |
| <a href="#">ISDN Trunks— General</a>                           | <a href="#">7-25</a> |
| <a href="#">Call-by-Call Service Selection</a>                 | <a href="#">7-42</a> |
| <a href="#">Facility and Non-Facility Associated Signaling</a> | <a href="#">7-49</a> |
| <a href="#">Wideband Switching</a>                             | <a href="#">7-56</a> |

| <b>Form</b>                                      | <b>Page</b>          |
|--|----------------------|
| <a href="#">Trunk Group Administration Forms</a> | <a href="#">7-71</a> |

## Automatic Transmission Measurement System

---

Automatic Transmission Measurement System (ATMS) measures transmission performance for voice and data trunk facilities. Performance is evaluated against user-defined threshold values.

The measurement report contains data on trunk signal loss, noise, signaling return loss, and echo return loss.

### How to administer ATMS

---

A Lucent Technologies administrator must enable ATMS on the System-Parameters Customer-Options form before you can administer ATMS.

#### Required forms

| Form                     | Field                           | Page                  |
|--------------------------|---------------------------------|-----------------------|
| ATMS Trunk Test Schedule | ■ All                           | <a href="#">7-76</a>  |
| Station                  | ■ Station Type<br>■ Port Number | <a href="#">6-28</a>  |
| Class of Restriction     | ■ Facility Access Trunk Test    | <a href="#">5-72</a>  |
| Hunt Group               | ■ All (optional)                | <a href="#">5-158</a> |
| Trunk Groups             | ■ All (ATMS Thresholds)         | <a href="#">7-115</a> |

### Detailed description

---

You can initiate ATMS to perform either demand testing or scheduled testing. Use the system administration terminal to perform demand testing. Use the ATMS Trunk Test Schedule form to set the testing schedule.

Trunk-test results are stored in a database. These measurements reflect the state of the trunk at the time of its last test. If trunks are tested on a regular basis, trunk measurements should not be more than 3 weeks old.

The entire set of measurements for all test cases is usually polled by an adjunct for historical reporting and printing.

Measurements can be output to a G3-MT printer, a system printer, or a G3-MA. If output is to a G3-MA, data is collected by a personal computer for offline analysis. Approximately 10 measurements are listed per page on a G3-MT screen; about 50 measurements are listed per page on a printer.



When a trunk fails a test twice and the administered busyout limit is not exceeded, then this trunk is busied out. You can administer the busyout limit at 25, 50, 75, or 100 percent, including trunks busied out for any reason. For example, if the limit is 25 percent and 30 percent of the trunks are busied out because of hardware problems, then a failing trunk is not busied out.

When a decision to busyout a trunk is made, the trunk is not rechecked when other events cause the number of busied-out trunks to change. This means that ATMS could take 25 percent of the trunks out of service, and a later hardware failure could take an additional 25 percent out of service. If the ATMS busyout limit is 25 percent, it is not rechecked and the trunks remain out of service.

Setting limits incorrectly can cause trunks to be busied out unnecessarily. Resetting limits does not immediately affect the busied-out state of a trunk. You can put the trunk back into service immediately by either changing the limits and running a demand test or using the release command on the entire trunk group.

## Terminating test lines

A terminating test line (TTL) is an extension over a DID or tie trunk that users call into to generate a random set of far-end measurements about the facility used to make the call. The originating switch compares the far-end measurements to the near-end measurements to determine the quality of the facility (per customer-set thresholds).

ATMS allows the following measurements for TTLs:

- Two-way transmission loss at 404 Hz, 1004 Hz, and 2804 Hz
- Near-end and far-end C-message and C-notched noise
- Near-end and far-end signaling and echo return loss
- Central office 100-type TTLs
- One-way transmission loss at 1004 Hz
- Near-end C-message noise
- Near-end signaling and echo return loss
- Central office 102-type TTLs
- One-way transmission loss at 1004 Hz
- Central office 105-type TTLs
- Two-way transmission loss at 404 Hz, 1004 Hz, and 2804 Hz
- Near-end and far-end C-message and C-notched noise
- Near-end and far-end signaling and echo return loss

## Test schedules

With R5r and later configurations, you can assign up to 30 test schedules. Each schedule consists of up to 60 trunk group/member fields. This allows you to create up to 1,800 different trunk group/member combinations for testing. With R5si and later configurations, you can assign up to 5 test schedules. Each schedule consists of up to 10 trunk group/member fields, allowing you to create up to 50 different trunk/group member combinations for testing. Administering this feature is a two-step process:

1. Define test times for each schedule
2. Assign trunks to the test times

After you define the test schedules, the system automatically makes the connections and takes the measurements at the specified time and day without any additional user intervention. Schedules ready to run are queued and run in a round-robin (FIFO) manner. Scheduled tests run until all trunk groups/members in the schedule have been tested or until the scheduled test duration is exceeded.

Test schedules assigned the same run time are selected to run based on the schedule number (smaller schedule numbers first).

### NOTE:

If schedules are assigned at the same time, it is unlikely that all scheduled tests will complete during the allotted time if other schedules are vying for the same resources.

## Determining schedule times

Trunk test schedules should run during trunk idle times (when resource consumption is low). The trunk idle times will be the time frames available for testing each node connected to the switch.

Once the idle times are determined, the next step is to compute the time required for testing the trunks between each node. Time requirements between each node are based on the quantity of trunks between nodes and the time needed to test each trunk to that node. Only outgoing trunks from the originating system need to be considered. Currently, there is no way to test incoming-only trunks in the near-end mode.

The characteristics of a trunk along with the test objectives are used to determine the total test time per trunk. The trunk characteristics might determine the type of test to run:

- Digital Facilities

For digital facilities that go between switching systems without needing digital channel banks, a supervision-only test is recommended to detect an initial tone from a TTL. For digital facilities that go between an analog CO switch and a digital PBX switch via a channel bank, all tests might be considered.

- 2-Wire Facilities

For 2-wire facilities such as local CO trunks, only loss and noise measurements are recommended since echo is usually not controlled on these facilities.

- 4-Wire Facilities

For 4-wire facilities such as interlocation tie trunks between different locations, all measurements are appropriate. For 4-wire facilities such as intralocation tie trunks (only wire conductors between switches), loss measurements may not be meaningful because of the short distances.

Test objectives might determine the per trunk test time, such as:

- How often you want to test various trunk groups. For example, you may want to test network trunks daily, but test non-network trunks only weekly. You may want to test more frequently immediately after installation and less frequently thereafter.
- You may want to test daily to all TTLs with free access and weekly to those with cost access.

After these objectives and characteristics have been considered, the test time for a trunk group is figured using the following formula:

$$TT = q [dt + nt + ttt]$$

Where:

- TT = the Trunk group test time in seconds
- q = the Number of trunks in the trunk group
- dt = the Dial time in seconds
  - For Touch Tone: 0.1 times (# of dialed digits)
  - For Rotary: 0.7 times (# of dialed digits) + 0.1 times (sum of dialed digits, with 0 equal to 10)
- nt = the Network time (always 2 seconds)
- ttt = the Transmission test time (see [Table 7-1](#))

**Table 7-1. Transmission Test Lines**

| <b>Test Type</b>                    | <b>Time (sec)</b> |
|-------------------------------------|-------------------|
| All Tests                           |                   |
| 56A (old)                           | 35                |
| 100                                 | 20                |
| 102                                 | 2                 |
| 105 (ZLC12,SN261)                   | 65                |
| 56A (new)                           | 65                |
| All Tests Except Return Loss        |                   |
| 56A (old)                           | 30                |
| 100                                 | 10                |
| LC/SN                               | 30                |
| 105 or new 56A                      | 50                |
| All Tests Except Self               |                   |
| 56A (old)                           | 20                |
| 105 (ZLC12,SN261)                   | 35                |
| 56A (new)                           | 35                |
| All Tests Except Self & Return Loss |                   |
| 56A (old)                           | 15                |
| 105 or new 56A                      | 25                |
| Supervision Tests                   |                   |
| All types                           | 2                 |

## ATMS test schedule example

Assume that the variables have the following values as an example for figuring the total test time for a trunk group:

$q = 100$

$dt = 0.7$  seconds (7 digits \* 0.1 seconds/digit)

$nt = 2$  seconds

$ttt = 65$  seconds (105 test type)

The total Originating Test Line (OTL) time required for this trunk group is 6,770 seconds.

Each trunk groups test time is assigned to an idle hour slot. The sum total of all test times assigned to a particular node should not exceed the idle time available for testing that node.

If the total test time exceeds the trunk idle hours, the following options are available:

- Additional TTLs can be added on the far-end nodes.
- The trunk group members can be split across schedules which test portions of a trunk group on alternate weeks.

### NOTE:

When setting up test times, the analog port in the TN771C cannot serve as an OTL and TTL at the same time.

## Managing OTL/TTL resources

Trunk group testing can occur concurrently when multiple boards exists. The number of available OTL resources determines the number of tests that can occur concurrently. Some internal limits have been set to control the number of concurrent tests. For background scheduling, the limit is four concurrent tests and the foreground demand test is limited to the number of maintenance users that can be operating simultaneously, which is currently set to three. Altogether, seven concurrent tests can run at the same time. If the number of OTL resources are less than the number of schedules being tested, the schedules are queued and tested sequentially.

OTLs are assigned to test schedule entries (a test entry is an individual trunk within a trunk group member/range field). Whenever an OTL is requested for test assignments, it is dedicated to the first available untested schedule entry on the test queue. An OTL remains dedicated to a schedule until all test entries in the schedule have been tested. When the last test entry in the schedule has been

tested, the OTL is assigned to the next untested schedule entry. A throttle parameter is provided which limits the number of OTLs that can be assigned per schedule.

When multiple OTL boards exist and the test schedule entries terminate at the same location, there must be a one-to-one correspondence between every OTL and TTL. When multiple OTLs terminate at the same TTL, the contention for the TTL will cause some tests to abort due to the far-end TTL being busy. One way to avoid this condition is to make sure that the number of far-end TTL resources equals the number of near-end OTLs used for testing. If this is not possible, limit the number of OTLs tested within each schedule with the OTL Throttle field to prevent entries within the same test schedule from originating multiple tests to a far-end system that can only support a single TTL resource. (This does not prevent entries from different schedules for competing for the same TTL resource.) In general, find the group within the schedule that has the fewest TTLs at the far end, and set the OTL Throttle field to this value.

**⇒ NOTE:**

If the OTL Throttle value is greater than the actual number of system OTLs, a test may be aborted due to the unavailability of an OTL resource.

If the OTL Throttle value for a schedule is 4, the next queued schedule cannot be run until all the entries from the current schedule are complete. This is because OTL resources are assigned to test schedule entries and not to test schedules. The use of the OTL throttle parameter can limit the number of entries being tested within the same test schedule and can, therefore, allow trunk group entries from different schedules to be tested concurrently.

### OTL throttle value example

To illustrate the use of the OTL throttle value, assume that the tests take the same amount of time to run and are administered as follows:

| Schedule # | Test time | OTL throttle | Trunk group | Members in trunk group |
|------------|-----------|--------------|-------------|------------------------|
| 1          | 1 am      | 4            | 10          | 4                      |
|            |           |              | 11          | 2                      |
| 2          | 1 am      | 1            | 12          | 1                      |
| 3          | 1 am      | 4            | 13          | 4                      |

All schedules are set to run at the same time. When the schedules are started, Schedule 1 is assigned 4 OTLs and Schedules 2 and 3 are put into a queue waiting for an OTL assignment. For the first round of tests the OTLs are assigned as follows:

| <b>OTL #</b> | <b>Assigned to schedule #</b> | <b>Trunk group/member assignment</b> |
|--------------|-------------------------------|--------------------------------------|
| 1            | 1                             | 10/1                                 |
| 2            | 1                             | 10/2                                 |
| 3            | 1                             | 10/3                                 |
| 4            | 1                             | 10/4                                 |

For the second round of tests the OTLs are assigned as follows:

| <b>OTL #</b> | <b>Assigned to schedule #</b> | <b>Trunk group/member assignment</b> |
|--------------|-------------------------------|--------------------------------------|
| 1            | 1                             | 11/1                                 |
| 2            | 1                             | 11/2                                 |
| 3            | 2                             | 12/1                                 |
| 4            | 3                             | 13/1                                 |

For the third round of tests the OTLs are assigned as follows:

| <b>OTL #</b> | <b>Assigned to schedule #</b> | <b>Trunk group/member assignment</b> |
|--------------|-------------------------------|--------------------------------------|
| 1            | 3                             | 13/2                                 |
| 2            | 3                             | 13/3                                 |
| 3            | 3                             | 13/4                                 |
| 4            |                               |                                      |

After this round of tests, all schedules have been tested and the OTLs are put back into an inactive state waiting for the next test schedule to start.

## **Considerations**

---

- At least one TN771C circuit pack is required because of the Local Area Network (LAN) bus maintenance which the board performs. The number of TN771C circuit packs administrable on the switch is limited by the number of EPNs and PPNs in a switch network. Each PPN contains one TN771C and each EPN may contain one TN771C. Each TN771C circuit pack supports testing of one analog trunk at a time. The number of OTL and TTL circuit packs required in a System depends on:
  1. The frequency that the customer requires their trunks to be tested
  2. The number of trunks
  3. The number of TTL devices on far-end switches that are available to test against
  4. The time per day that can be used for testing
- The number of concurrent tests that can be run is limited by the number of OTLs available and is also dependent on the type of test command, demand or scheduled. Demand test are limited to three concurrent tests, while scheduled tests are limited to four concurrent tests (such as 4 active OTLs). If more than four tests are needed simultaneously, the requests are queued and run on a round-robin basis. The number of TTLs that can be administered is limited by the number of available ports.

## **Interactions**

---

Interacts with the trunk threshold values defined on the Trunk Group form. The marginal values defined on that form are used to highlight measurements on the G3-MT report that are out of tolerance. The unacceptable values are used to identify (by blinking) the trunk members on the G3-MT report that are unusable. You can quickly identify out-of-tolerance or unusable trunks.



## DS1 Trunk Service

---

Digital Signal Level 1 (DS1) trunk service is bit-oriented signaling (BOS) that multiplexes 24 channels into a single 1.544-Mbps stream. DS1 can be used for voice or voice-grade data and for data-transmission protocols.

E1 trunk service is BOS that multiplexes 32 channels into a single 2.048-Mbps stream. Both T1 and E1 provide a digital interface for trunk groups.

### How to administer DS1 trunk service

---

#### Required forms

---

| Form                 | Field | Page                  |
|----------------------|-------|-----------------------|
| DS1 Circuit Pack     | ■ All | <a href="#">7-79</a>  |
| Trunk Group          | ■ All | <a href="#">7-115</a> |
| Access               |       | <a href="#">7-150</a> |
| APLT                 |       | <a href="#">7-168</a> |
| CO                   |       | <a href="#">7-168</a> |
| DID                  |       | <a href="#">7-178</a> |
| DIOD                 |       | <a href="#">7-183</a> |
| DMI-BOS              |       | <a href="#">7-188</a> |
| FX                   |       | <a href="#">7-193</a> |
| ISDN-PRI             |       | <a href="#">7-219</a> |
| RLT                  |       | <a href="#">7-252</a> |
| Tandem               |       | <a href="#">7-257</a> |
| Tie                  |       | <a href="#">7-262</a> |
| WATS                 |       | <a href="#">7-268</a> |
| Synchronization Plan | ■ All | <a href="#">7-112</a> |



**NOTE:**

Assign the DS1 circuit pack before you administer the members of the associated trunk groups.



**CAUTION:**

*If enhanced DS1 administration is not enabled, you cannot not make changes to the DS1 Circuit Pack form before you remove related member translations of all trunks from the trunk group.*

For information about how to administer DS1 with enhanced administration, see [“Enhanced DS1 administration” on page 7-14.](#)

## **Detailed description of DS1**

---

DS1 trunk service provides a digital interface for the following trunks.

- Voice-grade DS1 tie trunks
- Alternate voice/data (AVD) DS1 tie trunks
- Robbed-bit AVD (RBAVD) DS1 tie trunks
- Digital Multiplexed Interface (DMI) tie trunks
- ISDN-PRI trunks
- Central Office (CO) trunks
- Foreign Exchange (FX) trunks
- Remote-access trunks
- WATS trunks
- Direct Inward Dialing (DID) trunks
- Main/Satellite tie trunks
- Tie trunks that link Common-Control Switching Arrangement (CCSA) or Enhanced Private Switched Communications Service (EPSCS) networks
- Release-link trunks for Centralized Attendant Service (CAS)
- Access trunks
- Off-premises stations (also known as station-side DS1)
- Access endpoints (Release 5si and later configurations)

DS1 functions in public and private networks:

- Electronic tandem networks (ETN) or tandem tie-trunk networks (TTTN)
- Direct access to local exchange carriers

## DS1 operational and signaling parameters

[Table 7-2](#) provides the recommended combination of parameters for each DS1 interface.

**Table 7-2. DS1 Operational and signaling parameters**

| DS1 Circuit Packs            | # Trunk Members       | Bit Rate Mbps      | Companding              | Signaling Mode        | Trunk Type <sup>1</sup>       |                       |            |
|------------------------------|-----------------------|--------------------|-------------------------|-----------------------|-------------------------------|-----------------------|------------|
| TN722                        | 1-23                  | 1.544              | mulaw                   | common-chan           | Tie, DMI-BOS, CO <sup>2</sup> |                       |            |
|                              | 1-24                  |                    |                         | robbed-bit            | Tie                           |                       |            |
| TN722B                       | 1-23                  | 1.544              | mulaw                   | common-chan           | Tie, DMI-BOS, CO <sup>2</sup> |                       |            |
|                              | 1-24                  |                    |                         | robbed-bit            | CO/DID/Tie                    |                       |            |
| TN767D, E <sup>3</sup>       | 1-23                  | 1.544              | mulaw                   | common-chan           | Tie, DMI-BOS, CO <sup>2</sup> |                       |            |
|                              | 1-24                  |                    |                         | robbed-bit            | CO/DID/Tie                    |                       |            |
|                              | 1-23 (24th is D-chan) |                    |                         | isdn-pri <sup>4</sup> | ISDN                          |                       |            |
|                              | 1-24                  |                    |                         | isdn-ext <sup>4</sup> | ISDN                          |                       |            |
| TN464B <sup>5</sup>          | 1-30                  | 2.048              | alaw/mulaw <sup>6</sup> | CAS                   | CO/DID/Tie                    |                       |            |
|                              | 1-31                  |                    |                         | isdn-pri <sup>4</sup> | ISDN                          |                       |            |
|                              | 1-31                  |                    |                         | isdn-ext <sup>4</sup> | ISDN                          |                       |            |
|                              | 1-23                  | 1.544              | mulaw                   | common-chan           | Tie, DMI-BOS, CO <sup>2</sup> |                       |            |
| TN464C, D, E, F <sup>3</sup> | 1-24                  | 1.544 <sup>4</sup> | alaw/mulaw              | robbed-bit            | CO/DID/Tie                    |                       |            |
|                              | 1-23 (24th is D-chan) |                    |                         | isdn-pri <sup>4</sup> | ISDN                          |                       |            |
|                              | 1-31 (16th is D-chan) |                    |                         | 2.048                 |                               | ISDN                  |            |
|                              | 1-24                  |                    |                         | 1.544 <sup>4</sup>    | alaw/mulaw                    | isdn-ext <sup>4</sup> | ISDN       |
|                              | 1-31                  |                    |                         | 2.048                 |                               |                       |            |
|                              | 1-30                  |                    |                         | 2.048                 | alaw/mulaw                    | CAS                   | CO/DID/Tie |

*Continued on next page*

1. CO is any of the following trunk types: CO, FX, WATS.  
Tie is any of the following trunk types: access, tie, tandem, RLT, APLT.

2. Common-channel DS1 circuit packs used in CO trunk groups must have a trunk type of auto.
  3. Integrated CSU functionality is available only with the TN767D and TN464E or later-suffix DS1 circuit packs. Enhanced ICSU functionality only is available with the TN767E and TN464F or later-suffix DS1 circuit packs.
  4. Mixed-mode signaling is allowed. This means that if the signaling mode is isdn-ext or isdn-pri, a port from that circuit pack may be used in any trunk group that allows robbed-bit signaling.
  5. The TN464B's companding is based upon the system companding that you administer.
  6. ISDN-PRI calls are not guaranteed to work for the TN464B if the system's companding is set to mu-law.
- 

## Enhanced DS1 administration

---

You can change some of the fields on the DS1 Circuit Pack form without removing the related translations of all trunks from the trunk group if on the System-Parameters Customer-Options form DS1 MSP is enabled and you are assigned the associated login permissions. The following enhanced DS1 administration login permissions must be assigned on the Command Permission Categories form:

- Maintain Enhanced DS1 must be **y**.
- Maintain Trunks must be **y**.
- Maintain Switch Circuit Packs must be **y**.

If you busy out the DS1 circuit pack, you can change the following fields: `CRC`, `Connect`, `Country Protocol`, `Framing Mode`, `Interface`, `Interconnect`, `Line Coding`, and `Protocol Version`. After changing these fields, you may also have to change and resubmit associated forms.

## DS1 field implementation guidelines

The `ITC` (Information Transfer Capability) field appears on the route-pattern (Pattern Number) form, Trunk Group form, and Access Endpoint form. The `Line Coding` and the `Bit Rate` appear on the DS1 Circuit Pack form. Set the fields as shown below.

### ITC and corresponding Line Coding for bit rate 1.544-Mbps

---

| ITC field    | Line Coding field |
|--------------|-------------------|
| restricted   | ami-zcs           |
| unrestricted | b8zs              |

---

### ITC and corresponding Line Coding for bit rate 2.048-Mbps

| ITC field    | Line Coding field |
|--------------|-------------------|
| restricted   | ami-basic         |
| unrestricted | hdb3              |

The `Interconnect` field appears on the DS1 Circuit Pack form. The `Group Type` field appears on the Trunk Group form. Set the fields as shown below.

### Interconnect and corresponding Group Type entries

| Interconnect field | Group Type field                       |
|--------------------|--|
| co                 | co, did, diod, fx, or wats             |
| pbx                | access, aplt, isdn-pri, tandem, or tie |

## DS1 form implementation guidelines

For enhanced DS1 administration, field settings on the DS1 Circuit Pack form must be consistent with those on other forms. Therefore, if you change values on the DS1 form, you must change related values on the other forms and resubmit them.

### DS1 fields and corresponding forms (for ISDN)

| DS1 Circuit Pack field | Affected forms    | Page                  |
|------------------------|-------------------|-----------------------|
| Line Coding            | ■ Route Pattern   | <a href="#">8-67</a>  |
|                        | ■ Access Endpoint | <a href="#">7-72</a>  |
|                        | ■ PRI Endpoint    | <a href="#">7-102</a> |
|                        | ■ Signaling Group | <a href="#">7-106</a> |
|                        | ■ Trunk Group     | <a href="#">7-115</a> |
| Connect                | ■ Signaling Group | <a href="#">7-106</a> |
| Protocol Version       | ■ Signaling Group | <a href="#">7-106</a> |
| Interface              | ■ Signaling Group | <a href="#">7-106</a> |
| Interconnect           | ■ Trunk Group     | <a href="#">7-106</a> |
| Country Protocol       | ■ Signaling Group | <a href="#">7-106</a> |
|                        | ■ Trunk Group     | <a href="#">7-115</a> |

## Expanded technical information

### Signaling modes

Common-channel signaling (CCS) is an industry-standard technique in which any one of a group of channels carries the signals for the other channels. Lucent Technologies uses the 24th channel of a group for signaling. This signaling technique differs from 24-channel signaling. When the system is configured for Facility-Associated Signaling, 24-channel signaling uses the 24th channel in a DS1 facility to carry signals; this technique is also called clear channel, out-of-band, or alternate voice data (AVD) signaling.

Channel Associated Signaling (CAS) is similar to common-channel signaling, and is used only when the Bit Rate is 2.048 (the trunk is used with a CEPT1 (E1) interface). Signaling is carried on the 16th channel.

Robbed-bit signaling is a per-channel signaling technique for transmitting signaling bits on each channel in a DS1 facility. The least-significant bit in every 6th transmitted information frame is robbed and replaced by a signaling bit. This technique is also called in-band signaling.

ISDN-PRI signaling requires use of the TN767 or TN464 (C or later) DS1 interface circuit pack. Signaling is carried on the 24th channel for a 1.544 Mbps connection and the 16th channel for a 2.048 Mbps connection.

ISDN-ext signaling also requires use of the TN767 or TN464 (C or later) DS1 interface circuit pack. This choice enables the TN767 or TN464 to use ISDN signaling. Neither the 24th channel for TN767 nor the 16th channel for TN464 can be used as a D-channel. When the system is configured for Non-Facility-Associated Signaling, all channels on a DS1 facility may be used for voice or data. The system may be configured for Facility-Associated Signaling and Non-Facility-Associated Signaling at the same time.

### ISDN signaling requirements

For ISDN capabilities with the R5si and later configurations, the Processor Interface (PI) or Packet Control (PACCON) board is required. For ISDN capabilities with the R5r and later configurations, the Packet Interface (PKTINT) board is required. These boards terminate layer 2 (LAPD) of the PRI protocol.

## Public network signaling administration

**Table 7-3. DEFINITY ECS Public Network Access connections (ISDN-PRI Layer 3)**

| <b>Admin value</b> | <b>Country</b>        | <b>Protocol supported</b>  | <b>B-channel mtce msg</b> | <b>Interworking message</b> |
|--------------------|-----------------------|--|---------------------------|-----------------------------|
| 1 - a              | United States, Canada | AT&T TR 41449/ 41459 (tested with AT&T network, Canadian network, and MCI network) | Service                   | Progress                    |
| 1 - b              | United States         | Bellcore TR 1268; NIUF.302; ANSI T1.607  | Restart                   | Progress                    |
| 1 - c              | United States         | NORTEL DMS-250 BCS36/IEC01   | Service                   | Progress                    |
| 2                  | Australia             | AUSTEL TS014.1; Telecom Australia TPH 1856   | Restart                   | Progress                    |
| 3                  | Japan                 | NTT INS-NET  | Restart                   | Alerting                    |
| 4                  | Italy                 | ETS 300 102  | Restart                   | Progress                    |
| 5                  | Netherlands           | ETS 300 102  | Restart                   | Progress                    |
| 6                  | Singapore             | ETS 300 102  | Restart                   | Progress                    |
| 7                  | Mexico                | ETS 300 102  | Restart                   | Progress                    |
| 8                  | Belgium               | ETS 300 102  | Restart                   | Alerting                    |
| 9                  | Saudi Arabia          | ETS 300 102  | Restart                   | Progress                    |
| 10 - a             | United Kingdom        | ETS 300 102 (for connection to DASS II/DPNSS through external converter)           | Restart                   | Progress                    |
| 10 - b             | United Kingdom        | ETS 300 102 (Mercury); British Telecom ISDN 30                                     | none                      | Alerting                    |
| 11                 | Spain                 | Telefonica ISDN Specification  | Restart                   | Progress                    |
| 12 - a             | France                | VN4 (French National PRI)  | None                      | Alerting                    |
| 12 - b             | France                | ETS 300 102 modified according to P10-20, called Euronumeris                       | None                      | Alerting                    |
| 13 - a             | Germany               | FTZ 1 TR 6 (German National PRI)   | None                      | Alerting                    |
| 13 - b             | Germany               | ETS 300 102  | Restart                   | Alerting                    |

*Continued on next page*

**Table 7-3. DEFINITY ECS Public Network Access connections (ISDN-PRI Layer 3)**  
 — *Continued*

| <b>Admin value</b> | <b>Country</b>            | <b>Protocol supported</b> | <b>B-channel mtce msg</b> | <b>Interworking message</b> |
|--------------------|---------------------------|---------------------------|---------------------------|-----------------------------|
| 14                 | Czech Republic, Slovakia  | ETS 300 102               | Restart                   | Progress                    |
| 15                 | Russia (CIS)              | ETS 300 102               | Restart                   | Progress                    |
| 16                 | Argentina                 | ETS 300 102               | Restart                   | Progress                    |
| 17                 | Greece                    | ETS 300 102               | Restart                   | Progress                    |
| 18                 | China                     | ETS 300 102               | Restart                   | Progress                    |
| 19                 | Hong Kong                 | ETS 300 102               | Restart                   | Progress                    |
| 20                 | Thailand                  | ETS 300 102               | Restart                   | Progress                    |
| 21                 | Macedonia                 | ETS 300 102               | Restart                   | Progress                    |
| 22                 | Poland                    | ETS 300 102               | Restart                   | Progress                    |
| 23                 | Brazil                    | ETS 300 102               | Restart                   | Progress                    |
| ETSI - a           | Europe, New Zealand, etc. | ETS 300 102               | Restart                   | Progress                    |
| ETSI - b           |                           | ETS 300 102               | None                      | Progress                    |



## Digital Multiplexed Interface

---

Digital Multiplexed Interface (DMI) supports two signaling techniques: bit-oriented signaling and message-oriented signaling for direct connection to host computers.

### How to administer DMI

---

#### Required forms

---

| Form                 | Field | Page                  |
|----------------------|-------|-----------------------|
| DS1 Circuit Pack     | All   | <a href="#">7-79</a>  |
| Trunk Group          |       |                       |
| DMI-BOS              | All   | <a href="#">7-188</a> |
| ISDN-PRI             | All   | <a href="#">7-219</a> |
| Synchronization Plan | All   | <a href="#">7-112</a> |

### Detailed description

---

Use message-oriented signaling with ISDN-PRI. You cannot use ISDN-PRI for bit-oriented signaling.

DMI provides 23 64-kbps data channels, plus one 64-kbps channel for common-channel signaling. Within the data channel, DMI provides control-information exchange and data formats supporting data transport at all standard data rates. Use each data channel in one of the following transfer modes:

- Mode 0 — 64-kbps channel (raw, unformatted)
- Mode 1 — 56-kbps channel
- Mode 2 — 0 — 19.2-kbps synchronous/asynchronous
- Mode 3 — multiple virtual channels (up to 64k)

 **NOTE:**

TN767, TN464C, and later revisions of the DS1 circuit packs provide a DSX1 interface.

Access DMI trunks the same way as you access tie trunks. DMI trunks connect to host computers; Tie trunks connect to another switch. Each trunk functions like a PDM because the DMI protocol is identical to the DCP protocol used by the data modules.

## **Interactions**

---

- **Data Restriction**

DMI trunks cannot be data restricted.

- **Modem Pooling**

Data calls dialed from a local analog data endpoint to a DMI trunk contain the data-origination access code to obtain a conversion resource. Data calls on DMI trunks to local analog data endpoints obtain conversion resources.

## Enhanced ICSU

---

The Integrated Channel Service Unit (ICSU) is the combination of a 120A CSU module and a TN464E, TN767D, or later suffix DS1 circuit pack.

### NOTE:

The term 120A refers to the 120A1 and later suffix CSU modules. The TN767 and the TN464C and later revisions of the DS1 circuit packs provide a DSX1 interface.

The DS1 circuit pack automatically initializes and tests the 120A CSU module, and detects on-line alarms. The 120A CSU module, in combination with the DS1 circuit pack, provides the essential functions that have historically been provided by external CSUs. For more information about the ICSU, see *DEFINITY Communications System Generic 1, Generic 2, and Generic 3 V1 and V2 Integrated CSU Module Installation and Operation*.

The Enhanced ICSU functionality provides for the administration and maintenance of the ICSU by local and remote personnel. It also provides for additional performance measurements of a DS1 facility and for new loopback tests. Enhanced ICSU is only available for use in the US with 1.544 Mbps DS1 service. It requires a 120A CSU module with the TN767E, TN464F or later suffix DS1 board.

### NOTE:

A CSU module is not required for the Enhanced ICSU functionality for performance measurements or the on-demand long-duration loopback tests.

## How to administer Enhanced Integrated Channel Service Unit

---

The ICSU can be administered for connection to any DS1 trunk service.

The Enhanced ICSU is administered on the DS1 Circuit Pack form by entering the add ds1 or change ds1 command. On this form, when *Near-End CSU Type* is identified as **integrated**, additional CSU module administration options become available.

**Required forms**

| <b>Form</b>      | <b>Field</b>                     | <b>Page</b>          |
|------------------|----------------------------------|----------------------|
| DS1 Circuit Pack | ■ Near-End CSU Type              | <a href="#">7-79</a> |
|                  | ■ Transmit LBO                   |                      |
|                  | ■ Receive ALBO                   |                      |
|                  | ■ Upon DTE LOS                   |                      |
|                  | ■ Supply CPE Loopback Jack Power |                      |

**Detailed description**

**Testing**

The following testing and performance measurement functions can be performed with Enhanced ICSU.

- On-demand short-duration loopback testing of the DS1 board and CSU module, including board loopback, equipment loopback, and repeater loopback tests
- On-demand long-duration loopback testing of building wiring to the CPE loopback jack
- On-demand long-duration loopback testing to the far-end CSU
- On-demand long-duration 1-way span testing to and from remote test equipment or another DEFINITY ECS
- The ability to inject bit errors in long-duration loopback test patterns

The enhanced feature allows users to view long-duration loopback/span test results during testing on the DS1 Link Performance Measurements Summary report. The summary report provides loopback/span test information about the type of test being run, the pattern being sent, whether the DS1 board is synchronized to the looped test pattern, the bit-error count, and the test duration. It also provides performance information, described in the next section. See *DEFINITY Enterprise Communications Server System Monitoring and Reporting* for more detailed information including a sample summary report.

At any time during testing, Loopback/Span Test Bit-Error Count and Test Duration and `ESF Error Events` on the summary report can be cleared. Also, at any time during testing, the loopback test can be terminated.

## Performance measurements

The following performance measurements are added to the DS-1 Link Performance Measurements Summary report. An **N/A** in any of these fields indicates that enhanced functionality is not activated.

- Controlled slip seconds (CSS)
- Loss of frame count (LOFC)
- The Failed Seconds (FS) field is replaced by Unavailable/Failed Seconds (UAS/FS)
- ESF error events

The following performance measurements are added to the DS1 Link Performance Measurements Detailed Log report. An **N/A** in any of these fields indicates that enhanced functionality is not activated.

- Controlled slip seconds (CSS)
- Loss of frame count (LOFC)
- The Failed Seconds (FS) field is replaced by “Unavailable/Failed Seconds (UAS/FS)”

Performance measurement reports can be created for local, carrier-local, and remote facilities.

- Local reports display user measurements.  
These measurements are the user copies of the local (near-end) performance measurements and can be cleared by the user. They cannot be cleared by the carrier.
- Carrier-local reports display network measurements.  
These measurements are the carrier copies of the local (near-end) performance measurements. They can only be cleared by the carrier.
- Remote reports display remote CSU measurements.  
These measurements are available from the CSU at the far-end of the link. They can be cleared from the near-end of the link.

See *DEFINITY Enterprise Communications Server System Monitoring and Reporting* for additional information.

## **Considerations**

---

- The DS1 circuit pack must be taken out of service with the busyout board command before loopback/span tests can be run on-demand.
- Only one loopback/span test can be active at any one time on a DS1 facility.
- If the DS1 circuit pack is currently functioning as part of a network requested loopback test, loopback/span testing is denied.
- If the DS1 span is being used as the clock reference for the switch, a different reference must be selected before the DS1 span is looped.

## **Interactions**

---

None.

## ISDN Trunks— General

---

The Integrated Services Digital Network (ISDN) provides a message-oriented signaling method that allows information to be sent along with a call. ISDN gives you access to a variety of public and private network services and facilities. The ISDN standard consists of layers 1, 2, and 3 of the Open System Interconnect (OSI) model. DEFINITY ECS can be connected to an ISDN using standard frame formats: Basic Rate Interface (BRI) and the Primary Rate Interface (PRI).

An ISDN provides end-to-end digital connectivity and uses a high-speed interface which provides service-independent access to switched services. Through internationally accepted standard interfaces, an ISDN provides circuit or packet-switched connectivity within a network and can link to other ISDN supported interfaces to provide national and international digital connectivity.

ISDN supports the following:

- Call-by-Call Service Selection (CBC)
- Distributed Communications System (DCS) connectivity (Only ISDN-PRI supports DCS+ and DCS with Rerouting)
- Electronic Tandem Network (ETN) connectivity
- Facility Associated Signaling (FAS) and Non-Facility Associated Signaling (NFAS) (Only ISDN-PRI supports this)
- Generalized Route Selection (GRS)
- Call Identification Display — Calling Party Number (CPN) and Billing Number (BN)
- Administered Connections and Access Endpoints
- Interworking (a mixture of ISDN and non-ISDN trunking and stations)
- Wideband Switching (H0, H11, H12, and NxDS0) (Only ISDN-PRI supports this)
- QSIG Multivendor Connectivity
- Lookahead Inteflow
- Lookahead Routing
- Usage Allocation

The following forms (listed in [Trunk Group Administration Forms](#) on page [7-71](#)) are used in implementing ISDN:

- Access Endpoints
- ISDN-BRI and ISDN-PRI Trunk Groups
  - Supplementary Service Protocol (supports public network connection)
  - Calling Number (supports CPN)

- Incoming Call Handling Treatment Table (supports digit manipulation, CPN or BN requests, and night service destinations)
- CBC Trunk Group Usage Allocation form (supports Call-by-Call Service Selection Usage Allocation Plans)
- CBC Trunk Group Allocation Plan Assignment Schedule (supports Call-by-Call Service Selection Usage Allocation Plans)
- Wideband Support Options (supports Wideband Switching)
- ISDN Numbering — Private
- ISDN Numbering — Public or Unknown
- ISDN TSC Gateway Channel Assignment
- Network-Facilities (supports usage allocation used in Call-by-Call Service Selection)
- Signaling Group (group of B-channels for which a given D-channel or D-channel pair carries signaling information)

## How to administer ISDN

---

See [“ISDN-BRI trunk group” on page 7-198](#) or [“ISDN-PRI trunk group” on page 7-219](#) for instructions on how to administer ISDN. See the following features for information on how to administer each feature.

| Feature  | Page                  |
|--|-----------------------|
| Administered Connections                       | <a href="#">4-13</a>  |
| Call-by-Call Service Selection                 | <a href="#">7-42</a>  |
| Distributed Communications System              | <a href="#">12-11</a> |
| Facility and Non-Facility Associated Signaling | <a href="#">7-49</a>  |
| Generalized Route Selection                    | <a href="#">8-33</a>  |
| Lookahead Interflow                            | <a href="#">9-98</a>  |
| Lookahead Routing                              | <a href="#">8-45</a>  |
| QSIG Call Diversion                            | <a href="#">12-82</a> |
| QSIG Call Transfer                             | <a href="#">12-84</a> |
| QSIG Name Identification                       | <a href="#">12-86</a> |
| QSIG Path Replacement                          | <a href="#">12-90</a> |
| Wideband Switching                             | <a href="#">7-56</a>  |



## Detailed description

In ISDN-PRI, the transmission standard for layer 1 (the physical layer) is either DS1 T1 or E1. The DS1 T1 (used in North America and Japan) is a digital-transmission standard that carries traffic at the rate of 1.544 Mbps, and the E1 (used in Europe) carries traffic at a rate of 2.048 Mbps. The “D” (data) channel multiplexes signaling messages for the “B” (bearer) channels carrying voice or data. In a T1, when a D-channel is present, it occupies Channel 24. In an E1, when a D-channel is present, it occupies channel 16.

DEFINITY ECS offers several administrable protocols, each of which provides a different set of services that ISDN allows. See “DS1 Trunk Service” for more information. These protocols are discussed in detail later in this section. The following combination of services, including but not limited to Basic Call, Basic Supplementary Services, Supplementary Services with Rerouting, Display, and QSIG Networking are supported on the ISDN-PRI interface. The services available with global ISDN are country dependent.

With ISDN, DEFINITY ECS interfaces with a wide range of other products including switches, network switches, and host computers. These products include earlier DEFINITY communications systems, public network switches (for example, 4ESS, 5ESS, and Northern Telecom DMS250), and other products that adhere to the ISDN signaling protocol.

As an example of how ISDN is used in private- and public-network configurations, see [Figure 7-1](#) and [Figure 7-2](#). As seen, ISDN can be used to connect a switch to a public-switched network, a switch to a host computer, or a switch to another switch.

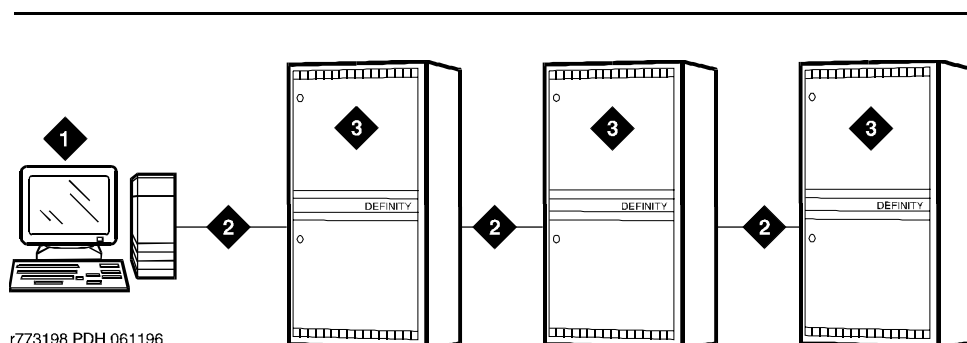

### Figure Notes

- 1. Host computer
- 2. ISDN trunk
- 3. DEFINITY ECS

Figure 7-1. ISDN private network configuration

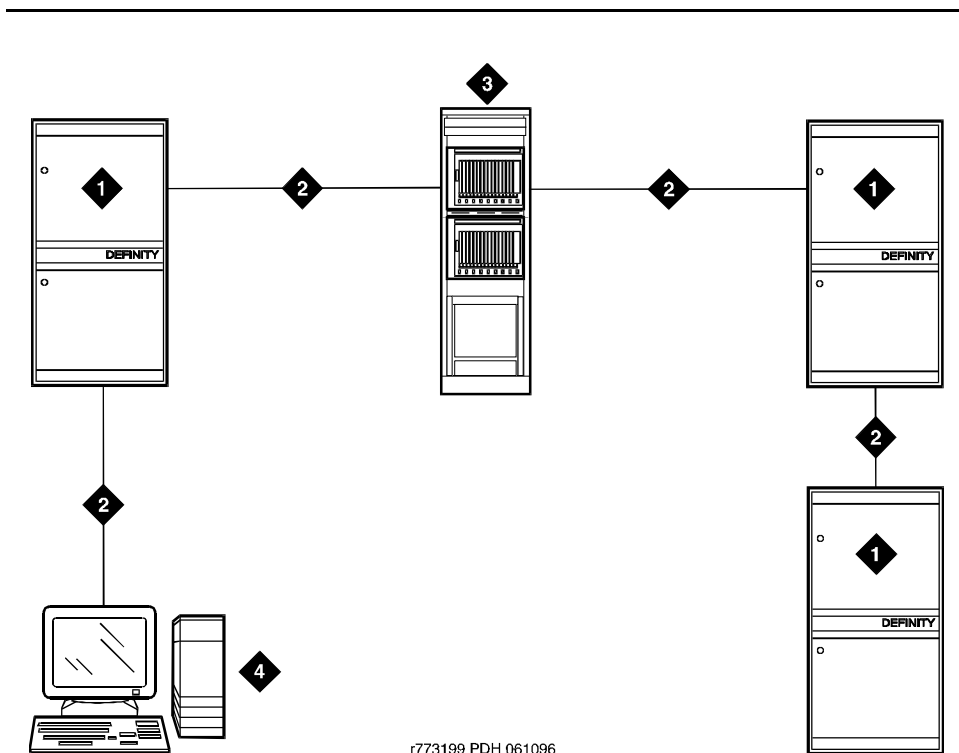

**Figure Notes**

- 1. DEFINITY ECS
- 2. ISDN trunk
- 3. Public switched network
- 4. Host computer

**Figure 7-2. ISDN public network configuration**

**AT&T Switched Network Protocol**

DEFINITY ECS supports the AT&T Switched Network Protocol described in the TR41449 (for 4ESS to common carrier) and TR41459 (for 5ESS to CO) ISDN protocol standards as defined by AT&T. This protocol is used when the DS1 circuit pack is administered for Country Code 1, Protocol Version a. The AT&T Switched Network provides you with the following services.

**Access to AT&T Switched Network Services**

ISDN provides access to AT&T Switched Network Services. See *Service Type* on the ISDN Trunk Group form for a table that outlines these switched-network services. An ISDN trunk group may be dedicated to a particular feature. Alternately, an ISDN call-by-call trunk group may provide access to several features. For a description of the services accessible via ISDN (either via dedicated or call-by-call trunk groups), see [“Call-by-Call Service Selection” on page 7-42.](#)

## Call Identification Display

ISDN Call Identification Display provides a transparent name and number display for all display-equipped voice terminals within an ISDN network. The feature is transparent in that the same information can be provided at all ISDN facilities. Voice terminals using this feature should be digital voice terminals with a 40-character alphanumeric display. The Merlin hybrid sets with 32-character displays (7315H and 7317H) also support this feature.

ISDN Call Identification Display is provided in addition to the normal Voice Terminal Display and Attendant Display features when the network supports end-to-end ISDN connectivity. When both ISDN and DCS display information are received, the switch can display either the DCS or ISDN call identification information. If only ISDN display information is received, information displays in ISDN format. See [“Expanded technical information” on page 7-34](#) for more detail on CPN and BN.

The display fields that may be used for ISDN are: Name, Number, Miscellaneous Call Identification, and Reason for Call Redirection. The display information varies, depending on the type of call, how the call is handled (for example, whether it is redirected or not), and the information is available on the call. The display information for basic calls (those with just a caller and called party) and for redirected calls is provided in [“Expanded technical information” on page 7-34](#).

## CPN/BN to Host Call Identification

The CPN/BN to Host Call Identification enables CPN and BN information to be passed from the switch to the ISDN Gateway, so that the ISDN Gateway can forward the information to a host for data-screen delivery to agents in an ACD split.

By delivering call-identification information such as CPN/BN and switch information such as the answering-agent's extension to an adjunct network (ISDN Gateway), the adjunct automatically delivers data screens to agents for new call arrivals and call transfers.

[Figure 7-3](#) shows a simplified diagram of a CPN- and BN-to-host arrangement. The ISDN Gateway is a UNIX or MSDOS computer connected to the switch on one side and to a host computer on the other side. The connection to the switch is over a synchronous interface with BX.25 protocol.

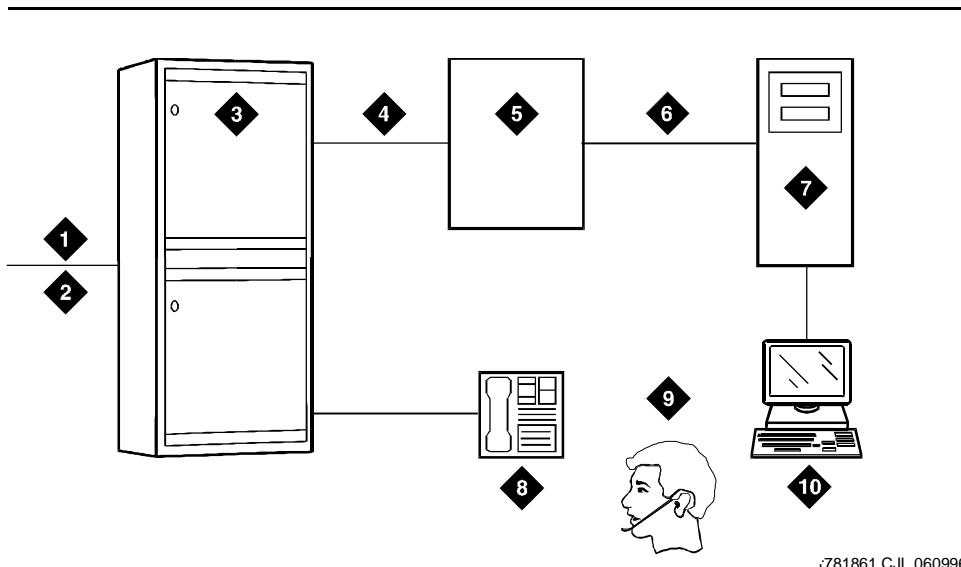

r781861 C.JL 060996

### Figure Notes

- |                 |                       |
|-----------------|-----------------------|
| 1. ISDN trunk   | 6. Existing interface |
| 2. SID/ANI      | 7. Host computer      |
| 3. DEFINITY ECS | 8. Voice terminal     |
| 4. BX.25        | 9. ACD agent position |
| 5. ISDN Gateway | 10. Data terminal     |

Figure 7-3. CPN- and BN-to-host configuration

## Private network services

In addition to providing access to switched-public networks, ISDN provides private-network services by connecting DEFINITY ECS in an Electronic Tandem Network (ETN), Distributed Communications System (DCS), or QSIG Network. This gives you more efficient private networks that support new integrated voice and data services. ETN, DCS, and QSIG networking services are provided as follows.

### ETN services

DEFINITY ECS that function as tandem nodes in an ETN can be interconnected using DS1 trunking facilities with ISDN. All signaling between the tandem switches is done with ISDN D-channel and normal ISDN protocol. The ISDN can also be used to connect ETN tandem and main switches. In this case, the main switch collects all of the address digits from local users as well as users at other satellite and tributary switches, and originates a call over ISDN to the tandem switch.

Automatic Alternate Routing (AAR) and Automatic Route Selection (ARS) are used with ISDN and DS1 trunking facilities to access ETN facilities. AAR and ARS are used to collect the dialing information for the call that is originated from the main switch.

### **DCS services**

ISDN-PRI facilities can be used in a DCS arrangement whenever tie trunks are used to connect the DCS nodes. Most DCS features are not affected by ISDN-PRI. However, there is a minor impact on a few of the DCS features, as far as the functions that the local and remote switches perform.

### **QSIG services**

QSIG networking provides compliance to the International Organization for Standardization (ISO) ISDN private-networking specifications. The QSIG Networking platform is supported over the ISDN Basic Call setup protocol. DEFINITY ECS supports QSIG Supplementary Services. For more information, see [“QSIG” on page 12-77](#).

### **Wideband Switching (ISDN-PRI only)**

Wideband Switching provides support for services that require large bandwidth, such as high-speed video conferencing. Wideband also supports multiple channel calls end-to-end. These services have traditionally been handled by dedicated facilities. With Wideband Switching, dedicated facilities are no longer a requirement for these large bandwidth services.

### **Call-by-Call Service Selection**

Call-by-Call Service Selection allows the same ISDN trunk group to carry calls to a variety of services or facilities. Embodied in this feature is the ability to allocate usage. It provides significant flexibility for creating user-defined incoming and outgoing services and is used on any ISDN trunk group.

### **Access to Software Defined Data Network**

With ISDN, the SDDN service may be accessed. SDDN provides virtual private-line connectivity via the switched public network. The services provided by SDDN include voice, data, and video applications. SDDN services complement the ISDN voice services.

### **Access to Switched Digital International**

Switched Digital International (SDI) provides 64 kbps of unrestricted connectivity to international locations via the AT&T Switched Network. It is also the backbone for the AT&T International ISDN network. SDI complements the ACCUNET digital service already available to United States locations. This service can be accessed using Call-by-Call Service Selection. SDI provides economical high-speed data transfer to international locations.

## National ISDN-2 Services

DEFINITY ECS supports National ISDN-2 (NI-2), which offers many of the same services as the AT&T Switched Network protocol. The NI-2 protocol is used when the DS1 circuit pack is administered for Country Code 1, Protocol Version b.

NI-2 provides users with the following services:

- Calling Line Identification
- Non-Facility Associated Signaling (ISDN-PRI only)
- D-Channel Backup (ISDN-PRI only)
- Wideband Switching (ISDN-PRI only)
- Call-by-Call Service Selection

### Calling Line Identification

Calling Line Identification for NI-2 is essentially Calling Party Number (CPN) identification, as previously described.

### Non-Facility Associated Signaling (ISDN-PRI only)

Non-Facility Associated Signaling (NFAS) allows an ISDN-PRI T1 or E1 Interface D-channel (signaling channel) to convey signaling information for B-channels (voice and data) on ISDN-PRI T1 or E1 facilities other than the one containing the D-channel. See [“Facility and Non-Facility Associated Signaling” on page 7-49](#) for more information.

### D-Channel Backup (ISDN-PRI only)

D-Channel Backup is provided to improve reliability in the event of a signaling-link failure. See [“Facility and Non-Facility Associated Signaling” on page 7-49](#) for more information.

### Wideband Switching (ISDN-PRI only)

Wideband Switching for NI-2 is essentially the same as that of the AT&T Switched Network ISDN-PRI protocol.

### Call-by-Call Service Selection

Call-by-Call Service Selection for NI-2 is essentially the same as that for the AT&T Switched Network ISDN-PRI protocol.

## ISDN interworking

ISDN interworking is a call that uses a combination of both ISDN trunking and station facilities and non-ISDN trunking and station facilities. A non-ISDN trunking facility is any trunk facility supported by the system that does not use the ITU-T recommended Q.931 message set for signaling. Non-ISDN trunking facilities include facilities such as analog trunks, AVD DS1 trunks, and DS1 trunks with bit-oriented signaling (robbed-bit or common channel).

DEFINITY ECS supports the conversion of ISDN signaling to non-ISDN in-band signaling and the conversion of non-ISDN in-band signaling to ISDN signaling for interworking purposes.

A mixture of ISDN and non-ISDN signaling is required in order to provide end-to-end signaling when using different types of trunk or station facilities on a call. See [Figure 7-4](#) for an example of interworking. In this example, a call for someone at Switch B comes into Switch A. Interworking allows the ISDN signaling of the call to be converted at Switch A to non-ISDN in-band signaling before the call forwards to Switch B. Even though the call comes into Switch A on an ISDN trunk, Switch A can send the call to Switch B over a non-ISDN trunk by converting the signaling information.

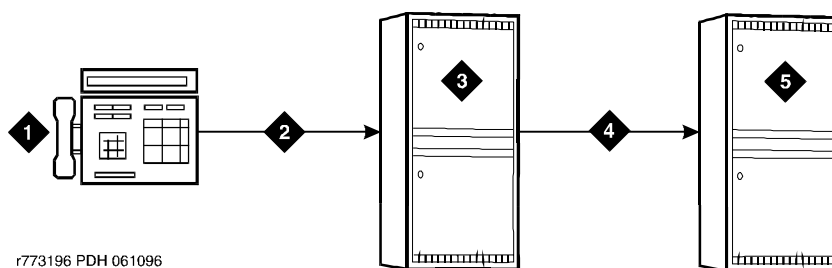

**Figure Notes**

- |                                  |                   |
|----------------------------------|-------------------|
| 1. Call from network to Switch B | 4. Non-ISDN trunk |
| 2. ISDN trunk                    | 5. Switch B       |
| 3. Switch A                      |                   |

**Figure 7-4. Interworking example**

The system provides accurate CDR billing information on calls that are not interworked. Accuracy of CDR billing information on interworked calls is equivalent to the accuracy provided by the public network.

DEFINITY ECS supports sending a non-ISDN trunk name as the connected name. Therefore, a non-ISDN trunk name can be sent as the connected name even when a call starts out as an ISDN call but is interworked over non-ISDN trunks.

## Expanded technical information

### ISDN-related hardware

ISDN-PRI is supported by the TN767 circuit pack (for assignment of a T1 signaling link and up to 24 ISDN-PRI trunk group members), or the TN464C or later circuit pack (for assignment of a T1 or E1 signaling link and up to 24 or 31 ISDN-PRI trunk group members, respectively). The TN2185 ISDN Trunk-side BRI circuit pack supports the ISDN-BRI trunk group.

- For R6si and later configurations, the D-channel is switched through either the TN765 Processor Interface (PI) circuit pack or the TN778 Packet Control (PACCON) circuit pack.
- For R6r and later configurations, the D-channel is switched through the TN1655 Packet Interface (PKTINT) circuit pack.

#### NOTE:

The TN767 cannot be used to carry the D-channel if either the TN778 (PACCON) or TN1655 (PKTINT) circuit pack is used to switch the D-channel; however, the TN767, in these circumstances, can be used for NFAS interfaces carrying only B-channels.

ISDN-BRI is supported by the TN2185 Trunk-side BRI circuit pack (for implementing the user side on the BRI interface) and the TN556B (or TN556C) and TN2198 ISDN BRI Line circuit packs.

- For R6si and R6vs and later configurations, the D-channel switches through the TN7778 Packet Control circuit pack.
- For R6r and later configurations, the D-channel switches through the TN1655 Packet Interface circuit pack.

A TN780 or TN2182 Tone Clock circuit pack provides synchronization for the ISDN-BRI Trunk circuit pack.

### Call Identification Display

Two types of identification numbers are provided with ISDN. These identification numbers may be used in the various types of displays used with ISDN. The two types of identification numbers are as follows:

- Calling Party Number (CPN): A 0–15 digit DDD number associated with a specific station. When a system user makes a call that uses ISDN, that user's CPN is provided by the system for ISDN. ISDN public-unknown numbering or ISDN private numbering forms are administered to create a 0–15 digit CPN from a local station number.
- Billing Number (BN): The calling party's billing number, which is provided to an inter-exchange network via Equal Access or Centralized Automatic Message Accounting (CAMA). This number is stored at either a local or network switch. If a customer is connected directly to the AT&T Switched



Network, the BN is the customer's billing number stored in that network. If the CPN is not provided on an incoming ISDN call, the network uses the BN for the station identification number.

The following types of display information are provided with ISDN.

- Calling Party's Number

The calling party's number appears on the called party's display. This number is provided only if the outgoing ISDN trunk group is administered to send the CPN, and if ISDN public-unknown numbering or ISDN private numbering forms are administered to create a CPN. On calls incoming to a system, the network may provide either the CPN or BN as the calling party's number. Extensions and 12-digit international numbers display without dashes. Dashes are only used for 7-digit and 10-digit numbers when `North American Area Code` is enabled on the Dial Plan form.

- Calling Party's Name

The calling party's name appears on the called party's display. On calls generated from a DEFINITY ECS, the calling party's name is provided if the ISDN trunk group is administered to send the name to the network. On calls incoming to a DEFINITY ECS, the (public or private) network may provide the calling party's name. If the calling party's name is not available, the called party's display shows "CALL FROM" instead, followed by the calling party's number (if available).

- Connected Party's Number

The connected party's number appears on the calling party's display. On calls generated from a DEFINITY ECS, the called party's number appears on the calling party's display as the calling party dials the number. If the (public or private) ISDN network provides the connected party's number, the calling party's display is updated to show the connected party's number. The format of the connected party's number is the same as that of the calling party's number described previously on calls incoming to a DEFINITY ECS. The 0–15 digit number of the party who answers the call is provided to the ISDN network only if the incoming ISDN trunk group is administered to send connected number to the network and ISDN public-unknown numbering or ISDN private numbering forms are administered to create a CPN.

 **NOTE:**

The connected party may be the party actually called, in the event the call is transferred before the connected party answers the call.

- Connected Party's Name

The connected party's name appears on the calling party's display. On calls generated from a DEFINITY ECS, the (public or private) ISDN network may provide the connected party's name to the DEFINITY ECS,

when the call is answered. If the connected party's name is not available, the calling party's display shows *ANSWERED BY*, followed by the connected party's number (if available).

On calls incoming to a DEFINITY ECS, the connected party's name is provided if the incoming ISDN trunk group is administered to send the name to the network.

## ISDN basic call

A basic ISDN call has both a caller and a called party, and the called party answers the call. When the caller goes off-hook, a= appears on the display. The digits then appear as they are dialed. These digits may be overwritten by the trunk group name if *Outgoing Display* of the Trunk Group Administration form is *y*. Once the called party (or a user with a bridged appearance for the called party) answers the call, the displays for the caller and called parties are described below.

- If *both the name and number information are available*, the displays are as follows. The *MISCID* (Miscellaneous Identification) field may be blank if that information is not available.

- Caller Display

- a= CALLED NAME CALLED NUMBER MISCID

- Called Party Display

- a= CALLER NAME CALLER NUMBER MISCID

- If *only the name information is available*, the displays are as follows:

- Caller Display

- a= CALLED NAME MISCID

- Called Party Display

- a= CALLER NAME MISCID

- If *only the number information is available*, the displays are as follows:

- Caller Display

- a= ANSWERED BY CALLED NUMBER MISCID

- Called Party Display

- a= CALL FROM CALLER NUMBER MISCID

- If *neither the name nor the number information is available*, the displays are as follows:
  - Caller Display (shows one of the following, depending on administration)
    - a= DIALED NUMBER                      MISCID
    - a= TRUNK NAME                          MISCID
  - Called Party Display
    - a= TRUNK NAME                          MISCID

## Redirected ISDN call

This is a call that has been redirected from the called party's extension by a feature such as Call Coverage, Call Forwarding All Calls, Bridged Call Appearance, or Call Pickup. Once the call is connected, the displays for the calling, called, and connected parties are as follows.

- Calling Party Display

a= CONNECTED NAME    CONNECTED NUM    MISCID

- Called Party Display

The following information appears on the display if the called party bridges onto the redirected call after it has been answered. In this situation, the connected party's display (given later) shows the same information. The calling party's display is also updated if the calling and called parties are on the same switch.

a= CONFERENCE 2

- Connected Party Display

The connected party is who answers the redirected call. The "R" indicates the reason for redirection.

a= CALLING ID    to    CALLED ID            R

The CALLING ID and the CALLED ID may be the name or the number, depending on what has been received from the far end.

## Interactions

---

- Attendant Display

The information provided by ISDN Call Identification Display is in addition to the display features already provided.

When an ISDN call is redirected to the attendant, and both name and number display information is available, the name displays on the console for the caller and called party identification. When a call is transferred or conferenced, DEFINITY ECS can redisplay DCS and ISDN caller/called/connected party information.

- Bridged Call Appearance

ISDN Call Identification Display information is provided at both the primary extension and the extension with the bridged call appearance. Both displays show the same called-party information, whether the call is made from the primary extension or the bridged call appearance. On a call to a primary extension, the caller's display shows the identification of the called primary extension, even if the call is answered by the bridged call appearance.

- Call Forwarding

When an ISDN call is forwarded, no ISDN Call Identification Display information is shown on the display of the forwarding extension.

The forwarded-to extension's display shows information on the caller, called party (if the forwarded-to station is on the same switch), and the reason for redirection.

- Call Pickup

When an ISDN call is answered via Call Pickup, the caller's display identifies the answering party, the called party's display identifies the caller, and the answering party's display identifies both the caller and called parties.

- Caller Information Forwarding

With CINFO you can use a vector *collect digits* step to retrieve caller entered digits (ced) and customer database-provided digits (cdpd) supplied by the network in an incoming call's ISDN SET UP message. ISDN is required if the CINFO comes from the network.

- Conference — Attendant

A conference call is identified as a call with "n" number of conferees. This display information generates locally and does not change the display on another switch. If the conference call eventually drops back to a two-party call, the original display information is restored.

- Conference — Terminal

A conference call is identified as a call with “n” number of conferees. This display information generates locally and does not change the display on another switch. If the conference call eventually drops back to a two-party call, the original display information is restored. However, when two DCS and/or ISDN calls (or any possible combination of each) are conferenced and revert to a two-party call, the trunk group of the remaining call displays.

- DCS

If both DCS and ISDN features are provided over the same facility with a DEFINITY ECS, DCS displays generally override ISDN displays. However, with DEFINITY ECS, the ISDN connected name and number can override the DCS called name and number if `Display Connected Name/Number for ISDN DCS Calls` is `y` on the Feature-Related System Parameters form

When two DCS and/or ISDN calls (or any possible combination of each) are conferenced and revert to a two-party call, the trunk group of the remaining call displays.

- Facility Restriction Level and Traveling Class Mark

The TCM used to pass on the originating facility’s FRL is sent by ISDN facilities in the SETUP message only if the trunk services type is tandem.

- Hold

When an ISDN call is placed on Hold, the display of the party who activates Hold goes blank, and then identifies the new caller or connected party, if there is one. The held party’s display remains unchanged. When the held party is reconnected to the holding party, the holding party’s display is updated to indicate the current status of the call.

- Hunting

On ISDN calls to a hunt group extension, the caller’s display identifies either the hunt group name or the group member who answers the call, depending on hunt group administration.

- Information Indicator Digits (II-digits)

With II-digits you can make vector-routing decisions based on the type of the originating line. II-digits are provided for an incoming call by ISDN-PRI. It is a generally available ISDN AT&T Network service.

- LookAhead Interflow

LookAhead Interflow requires ISDN connectivity end-to-end over a private network.

- Look Ahead Routing

Look Ahead Routing allows you to continue to try to reroute an outgoing ISDN call when initial attempts fail because you receive certain cause values which indicate a congestion situation. You can indicate the next route-pattern preference or indicate that the current route pattern should be attempted again.
- Malicious Call Trace

ISDN calling number identification is sent when MCT notification is activated on an ISDN trunk.
- Multiple Subscriber Number (MSN) - Limited

The ISDN standard MSN feature lets you assign multiple extensions to a single BRI endpoint. A side effect of supporting the NT interface is the MSN feature works with BRI endpoints allowing the Channel ID IE to be encoded as “preferred.” The endpoint must be administered as the far end of an NT-side ISDN-BRI trunk group. Also, you must use the Uniform Dial Plan (UDP) feature to assign the desired extensions to the “node” at the far end of the trunk group.
- Overlap Sending

You can administer overlap sending on AAR and ARS calls routed over ISDN trunk groups. This allows you to send and receive digits one digit at a time instead of enbloc. (With enbloc, digits are not sent until the entire group of digits is received).
- Terminating Extension Group

On ISDN calls to a TEG, the caller’s display identifies either the group or the group member who answers the call, depending on administration.
- Transfer

When a call is transferred across an ISDN trunk, the display of the party who transfers the call goes blank. The transferred party’s display does not change. The display of the transferred-to party identifies the party transferred.

When an ISDN call is transferred to a party on the same switch as the party who transfers the call, the information on the display of the party who transfers the call shows on the transferred-to party’s display.

When QSIG Call Transfer is enabled for a non-DCS ISDN call, the transferred-to party’s name and number displays for the party that was not transferred.
- Voice Terminal

The information provided by ISDN Call Identification Display is in addition to the display features already provided.

When an ISDN call is redirected to a voice terminal, and both name and number display information are available, the name displays on the terminal for the calling and called party identification. When a call is

transferred or conferenced, DEFINITY ECS can redisplay DCS and ISDN calling/called/connected party information. However, when two DCS and/or ISDN calls (or any possible combination of each) are conferenced and revert to a two-party call, the trunk group of the remaining call displays.

## Call-by-Call Service Selection

Call-by-Call Service Selection enables a single ISDN trunk group to carry calls to a variety of services. It does not require that each trunk group be dedicated to a specific service. It allows you to set up various voice and data services and features for a particular call.

### How to administer Call-by-Call Service Selection

You administer Call-by-Call Service Selection on a per trunk group basis.

#### Required forms

| Form  | Field   | Page                  |
|---|---|-----------------------|
| System-Parameters<br>Customer-Options           | <ul style="list-style-type: none"> <li>■ Version</li> <li>■ ISDN-PRI</li> <li>■ ISDN-BRI Trunks</li> <li>■ Usage Allocation Enhancements</li> </ul> | <a href="#">5-277</a> |
| ISDN-PRI Trunk Group                            | <ul style="list-style-type: none"> <li>■ Service Type</li> <li>■ Usage Alloc</li> </ul>   | <a href="#">7-219</a> |
| — Incoming Call Handling Treatment (ICHT) Table | <ul style="list-style-type: none"> <li>■ All</li> </ul>   |                       |
| ISDN-BRI Trunk Group                            | <ul style="list-style-type: none"> <li>■ Service Type</li> <li>■ Usage Alloc</li> </ul>   | <a href="#">7-198</a> |
| — Incoming Call Handling Treatment (ICHT) Table | <ul style="list-style-type: none"> <li>■ All</li> </ul>   |                       |
| Route Pattern                                   | <ul style="list-style-type: none"> <li>■ IXC</li> <li>■ Service/Feature</li> <li>■ Band</li> </ul>  | <a href="#">8-67</a>  |

You can administer trunk Usage Allocation for multiple called numbers within a given Service/Feature, or you can administer trunk Usage Allocation for incoming or outgoing calls independent of Service/Feature.



### Required forms

| Form                                  | Field                           | Page                  |
|---------------------------------------|---------------------------------|-----------------------|
| System-Parameters<br>Customer-Options | ■ Version                       | <a href="#">5-277</a> |
|                                       | ■ ISDN-PRI Trunks               |                       |
|                                       | ■ ISDN-BRI Trunks               |                       |
|                                       | ■ Usage Allocation Enhancements |                       |
| Network-Facilities                    | ■ All                           | <a href="#">7-100</a> |

### Detailed description

Call-by-Call Service Selection uses the same route patterns and route preferences that are used by Automatic Alternate Routing (AAR), Automatic Route Selection (ARS), and Generalize Route Selection (GRS). The service or facility used on an outgoing Call-by-Call Service Selection call is determined by information assigned in the AAR/ARS/GRS route patterns.

You can allow a variety of services to use a single trunk group. The system obtains trunking efficiency by distributing traffic over all the available trunks. Then you can assign services that are used on incoming and outgoing Call-by-Call Service Selection calls.

Using Country Protocol 1, you integrate services and features such as MEGACOM, ACCUNET, and INWATS onto a single transmission facility (ISDN-PRI trunk group) with flexible assignment of trunks to each service or feature. Calls such as an incoming 800 Service call that requires through-switching as an Outgoing WATS call can be routed via the same facility. See the ISDN-PRI trunk group form on page [“ISDN-PRI trunk group” on page 7-219](#) for a listing of available services.



**NOTE:**

When the DEFINITY ECS is connected to 5ESS, all of the services supported under the Lucent Technologies and NI-2 country options are available.

A Call-by-Call Service Selection example is shown in [Figure 7-5](#).

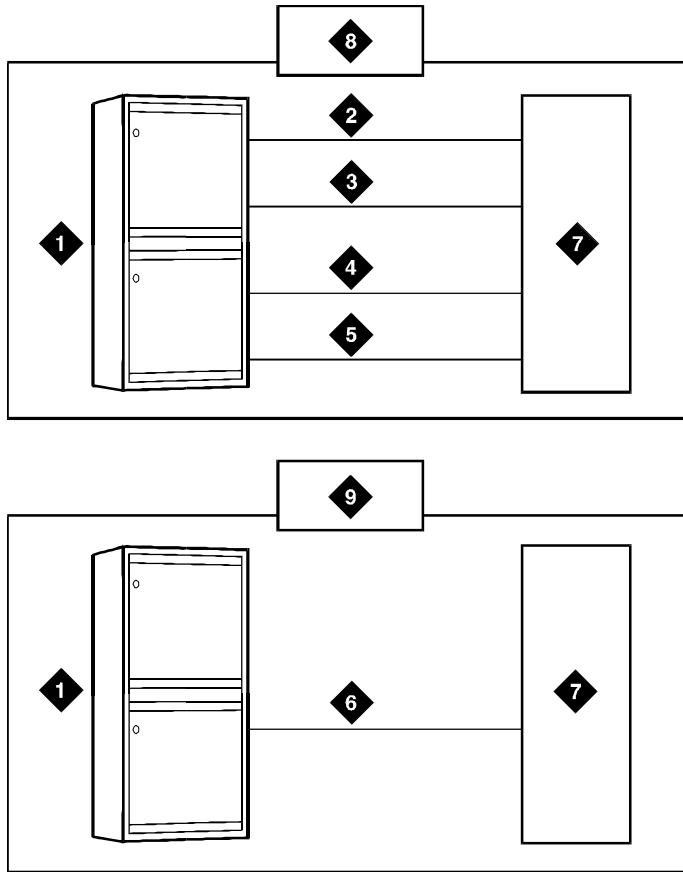

r773197 CJL 060396

**Figure Notes**

- |                            |   |
|----------------------------|---|
| 1. DEFINITY ECS            | 6. Call-by-Call Service Selection trunk group |
| 2. Megacom trunk group     | 7. Public-switched network                    |
| 3. Megacom 800 trunk group | 8. Without Call-by-Call Service Selection     |
| 4. SDN trunk group         | 9. With Call-by-Call Service Selection        |
| 5. OUTWATS trunk group     |   |

**Figure 7-5. Call-by-Call Service Selection example**

## ISDN messages and information elements for Usage Allocation

Understanding the technical details of ISDN messages and information elements may help you implement ISDN.

Call-by-Call Service Selection allows the system to specify one of the preceding service types on a call-by-call basis. You can specify service types by classifying incoming calls to an ISDN Call-By-Call trunk group using the called-party's number.

You can also specify service types with a SETUP message that indicates the intent of the originating system to initiate a call using the specified service or facility. The SETUP message may contain units called information elements (IE) that specify call-related information. The IE used with Call-by-Call Service Selection are:

- Network-Specific Facility (NSF) — Indicates which facilities or services are to be used to complete the call (typically not used outside the US and Canada).

The system also checks all incoming ISDN trunk calls for the presence of an NSF IE. If an NSF IE is present, the system makes sure that the requested service is compatible with the trunk administration before it accepts a call.

For an outgoing call on a Call-By-Call trunk group, the NSF IE is constructed using the Service/Feature specified on the routing-pattern preference selected for the call.

If the Service/Feature specified does not have an associated NSF, an NSF IE is not sent. For example, SETUP messages for incoming and outgoing calls classified only by a called-party number do not contain an NSF IE.

- Transit Network Selection — Indicates which interexchange carrier is to be used on an inter-LATA call.

If a call requires both the Service/Feature and the interexchange carrier to be specified, the interexchange carrier information is sent in the NSF IE rather than the Transit Network Selection IE.

## Usage Allocation Plans

Optional Usage Allocation Plans (UAP) may be assigned to provide more control over a Call-by-Call Service Selection trunk group. You can allocate a minimum and maximum number of channels for incoming and outgoing called numbers, privileged users, and voice and data calls.

A UAP allows the customer to set the following options:

- Maximum number of trunks that each service can use at any given time. The sum for all services may exceed the total number of trunk-group members. For example, for a 15-member trunk group, you could administer a maximum of seven MEGACOM service calls, six MEGACOM

800 service calls, and eight SDN calls. This ensures that all trunk-group members are not dominated by a specific service, yet allows for fluctuations in demand.

- Minimum number of trunks that always must be available for each service. The sum for all services may not exceed the total number of trunk-group members. For example, for a 10-member trunk group that provides access to MEGACOM service, MEGACOM 800 service, and SDN, the minimum number of trunks to be used for each of these services cannot add up to more than 10.

When these UAP limits are exceeded, the system rejects the call, even if a trunk is available. On outgoing calls, the calling party receives a reorder tone unless other preferences are available.

You can assign either fixed or scheduled UAP for each Call-by-Call Service Selection trunk group.

- With a fixed UAP, one plan applies at all times.
- With a scheduled UAP, different plans can be administered to apply at different times of day and days of week. As many as 6 activation times and associated plans can be assigned for each day of the week.

You can have anything from a simple fixed UAP to a very flexible UAP with many scheduling options. You can even start out with no UAP and build one as the need arises.

## Incoming Call-Handling Treatment

Call-by-Call Service Selection provides special Incoming Call-Handling Treatment for ISDN trunk groups. An incoming call on an ISDN trunk is handled according to a treatment table administered for the trunk group. Depending on the platform you use, the table allows for a different number of combinations of call treatments.

The treatment for an incoming call is selected based on the first 3 columns in the ICHT table on the ISDN Trunk Group form. When the attributes of an incoming call match these specifications, the call is treated according to the corresponding following 4 columns. If an incoming call matches more than one set of specifications, the most restrictive case applies. [Table 7-4](#) lists the possible cases from most restrictive to least restrictive.

**Table 7-4. Call-by-Call Service Selection specifications**

|                   | Service / Feature | Called Len    | Called Number                             |
|-------------------|-------------------|---------------|---|
| Most restrictive  | Specified         | Specified     | x leading digits specified                |
|                   | Specified         | Specified     | y leading digits specified, where $y < x$ |
|                   | Specified         | Specified     | not specified                             |
|                   | Specified         | Not specified | not specified                             |
|                   | “other”           | Specified     | x leading digits specified                |
|                   | “other”           | Specified     | y leading digits specified, where $y < x$ |
|                   | “other”           | Specified     | Not specified                             |
| Least restrictive | “other”           | Not specified | Not specified                             |

## Considerations

Call-by-Call Service Selection provides the following benefits:

- Cost reduction — Since many services share the same trunks, the total number of trunks can be reduced.
- Improved service — Features and services are less likely to be blocked.
- Simplified Networking — Network engineering is simplified because analysis of trunking needs can be done based on total traffic instead of on a per-service basis.
- Timely response to changes — With UAPs, the network does not have to be consulted.
- Measurement of Call-by-Call Service Selection calls

## Interactions

- Automatic Alternate Routing and Automatic Route Selection  
 Call-by-Call Service Selection uses the same routing tables and routing preferences that are used by AAR and ARS.

- Call Detail Recording

On successful call attempts using ISDN Call-By-Call trunk groups, CDR records the NSF specified by the call's NSF IE. CDR refers to this information as the ISDN Network Service (INS). The value passed to CDR is the 3-digit equivalent of NSF IE. NSF information for Facility Type 2 calls (used with ISDN-Pri Call-by-Call trunk groups) also is recorded if the NSF is available in the incoming SETUP message.

If an outgoing Call-by-Call Service Selection call uses an interexchange carrier other than the presubscribed common carrier, CDR records the 3-digit or 4-digit Interexchange Carrier Code (IXC). CDR may not record the IXC properly if the dialed-code format differs from the US IXC formats.

When a Call-by-Call Service Selection call is rejected because of a UAP, CDR records the cause as an ineffective call attempt. The NSF recording takes place also for the user-defined Facility Type 2. However, the NSF recording takes place only if the NSF is available in the incoming SETUP message.

- Generalized Route Selection

Call-by-Call Service Selection uses the same routing tables and routing preferences used by GRS.

- Multiquest Flexible Billing

Do not use a Service/Facility with `Facility Type` set to **2** or **3**. NSF processing is not performed for Facility Type 2. An NSF is not included in the outgoing SETUP message for Facility Type 3.

- Time-of-Day Routing

Any Time-of-Day Routing administration that affects routing preference also affects Call-by-Call Service Selection. Use Time-of-Day Routing to vary the IXC based on the time of day and day of week.

- Traffic Measurements

The system provides traffic measurements for each individual service administered for a ISDN Call-by-Call Service Selection trunk group.

## Facility and Non-Facility Associated Signaling

---

Facility Associated Signaling (FAS) allows an ISDN-PRI T1/E1 interface D-channel to carry signaling information for the 23 bearer (B) channels on its associated span.

Non-Facility Associated Signaling (NFAS) allows an ISDN-PRI T1/E1 interface D-channel to carry signaling information for the 23 bearer (B) channels on its associated spans. With NFAS, one D-channel can carry signaling for up to 300 B-channels.

### How to administer FAS and NFAS.

---

#### Required forms

| Form                 | Field               | Page                  |
|----------------------|---------------------|-----------------------|
| Signaling Group      | ■ All               | <a href="#">7-106</a> |
| ISDN-PRI Trunk Group | ■ Port<br>■ Sig Grp | <a href="#">7-219</a> |
| DS1 Circuit Pack     | ■ Signaling Mode    | <a href="#">7-79</a>  |

### Detailed description

---

A D-channel can carry signaling information for numerous B-channels located on different DS1/E1 circuit packs.

#### NOTE:

NFAS is only valid for DS1/E1 Country Protocol 1.

### D-Channel Backup with NFAS

When NFAS is used, a backup D-channel can be administered to improve reliability. The system switches to the backup D-channel if a signaling link failure occurs on the primary D-channel span.

One D-channel is administered as the Primary D-channel and another D-channel is administered as the Secondary D-channel. These assignments ensure that both D-channels are in the same state at the same time and neither can be used to carry B-channel traffic at any time. The Primary D-channel is given precedence over the Secondary D-channel.

When D-Channel Backup is activated, all calls that have been answered are preserved. However, some call-related information may be lost. Calls that are not answered when D-channels are switched also may lose call-related information.

Figure 7-6 shows a possible configuration involving 3 ISDN-PRIs between a DEFINITY ECS and another DEFINITY ECS or the public network. With DS1 (24 channel) interfaces, 2 of the ISDN-PRIs contain a D-channel and 23 B-channels, while the other ISDN-PRI contains 24 B-channels. One of the D-channels is the Primary D-channel, and the other is the Secondary D-channel. Together, this pair of D-channels signals for all 70 (23+24+23) of the B-channels that are part of the 3 PRIs.

Since the D-channels are signaling for more than one DS1/E1 facility, D-Channel Backup requires the use of NFAS. At any given time, one of the two D-channels is carrying Layer 3 signaling messages, while the other D-channel is active at layer 2, but in a standby mode only. Any layer 3 messages received over the standby D-channel are ignored. Since only one of the D-channels can be active at a time, load sharing between the two D-channels is not possible. The two D-channels can provide signaling for only a predefined set of B-channels and cannot dynamically backup other D-channels on other interfaces.

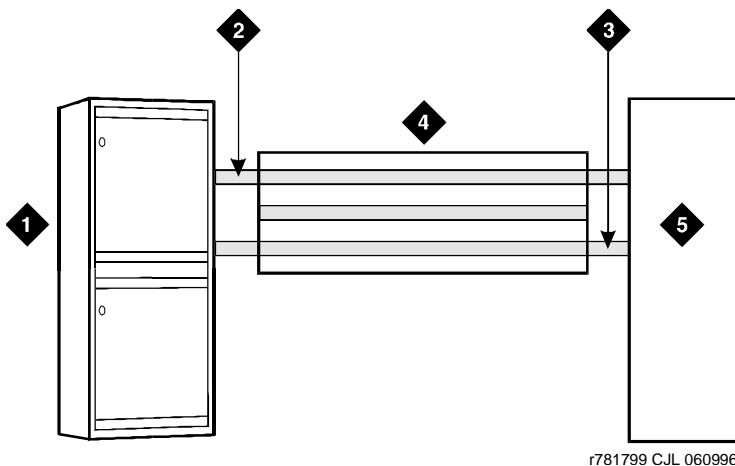

**Figure Notes**

- 1. DEFINITY ECS
- 2. Secondary D-Channel
- 3. Primary D-Channel
- 4. ISDN-PRI controlled by D-Channel
- 5. Network Far-End Switch DEFINITY ECS

Figure 7-6. Example D-Channel Backup with 3 ISDN-PRIs



## D-Channel Backup activation

- D-Channel Failure

If the signaling link fails on the active D-channel (D1) or the hardware carrying D1 fails, the system sends a message over the standby D-channel (D2). D2 then becomes the active D-channel and carries all subsequent signaling messages. When the signaling link or hardware on D1 recovers from the failure, D1 becomes the standby D-channel.

- System Technician Commands

If a system technician commands that a D-channel switchover take place, the first action taken by the system is to tear down the signaling link on D1. After this is completed, a message is sent on D2 to request that D2 become the active D-channel. D2 then becomes the active D-channel and the switchover is complete.

## Guidelines for administering FAS and NFAS

Coordinate the following when implementing FAS and NFAS:

- Decide which DS1/E1 facilities will use FAS.
- Decide which of the remaining DS1/E1 facilities carries D-channel signaling information on the 16th (E1) or 24th (DS1) channel. For those channels that have a D-Channel Backup, D-channel pairs must be allocated.
- Define Signaling Groups. A Signaling Group is a group of B-channels for which a given D-channel (or D-channel pair) carries the signaling information. Each Signaling Group must be designated as either a FAS or NFAS Signaling Group.
  - A FAS Signaling Group must contain all the ISDN B-Channels on the DS1/E1 interface associated with the group's D-channel, and cannot contain B-channels from any other DS1/E1 circuit pack. For 24-channel DS1 boards, some of the DS1 ports may use in-band (robbed-bit) signaling and be members in a tie trunk group rather than an ISDN trunk group. These tie trunks cannot be members of a Signaling Group.
  - There is no restriction on which DS1/E1 ports can belong to an NFAS Signaling Group. Normally, an NFAS Signaling Group consists of one or two D-channels and several complete DS1/E1 interfaces.

If a Signaling Group contains only a subset of a DS1/E1's B-channels (ports 1–12, for example), it is considered an NFAS Signaling Group, not a FAS Signaling Group. The remaining B-channels on the DS1/E1 are then assigned as members of another NFAS Signaling Group.

- An Interface ID must be assigned to each DS1/E1 facility in an NFAS Signaling Group. For example, if the B-channels in a Signaling Group span 3 DS1/E1 facilities, a unique Interface ID must be assigned to each of the 3 DS1/E1 facilities. This designation is required to uniquely identify the same B-channel (port) number on each of the DS1/E1 facilities in the Signaling Group. Therefore, this interface must be agreed upon by both sides of the interface and administered prior to initialization.
- Primary and Secondary D-Channel Backup must be agreed upon by both sides of the interface and administered prior to initialization. If the IDs do not match, the signaling group will come up but calls will fail.

The following forms show the DS1 interface configuration for NFAS. When implementing FAS and NFAS, the DS1 form must be submitted first, followed by the Interface Link and associated forms, followed by the ISDN-PRI trunk group, Signaling Group, and Trunk Group Members forms.

The Interface Link and associated forms may be administered at any time after the DS1 forms have been administered, with the following restrictions:

- A D-channel cannot be assigned on a Signaling Group form unless the associated link is disabled.
- A trunk member cannot be assigned unless its associated Signaling Group has been administered.

The `Signaling Mode` must be specified for each DS1 circuit pack. Because this circuit pack has `Signaling Mode` set to `isdn-ext`, all trunks on this circuit pack are signaled using either inband robbed-bit signaling, or by a D-channel on another DS1 circuit pack.

```

                                     Page 1 of 1
                DS1 CIRCUIT PACK
Location: 1B17                               Name: _____
Bit Rate: 2.048                             Line Coding: hdb3
Signaling Mode: isdn-ext
Interface Companding: 5law
Idle Code: 11111111
MAINTENANCE PARAMETERS
Slip Detection? n                           Remote Loop-Around Test? n
```

Screen 7-1. DS1 Circuit Pack form (Signaling Mode = isdn-ext)

Next, Signaling Groups are administered using Signaling Group forms.

Page 1 of 1

SIGNALING GROUP

Group Number : 1      Associated Signaling? n      Max number of NCA TSC: 0  
                                 Primary D-Channel: 1B1524      Max number of CA TSC: 0  
                                 Secondary D-Channel: 1B1624      Trunk Group for NCA TSC: \_\_\_  
                                 Trunk Group for Channel Selection: \_\_\_\_\_

| Trunk Brd | Interface ID | Trunk Brd | Interface ID |
|-----------|--------------|-----------|--------------|
| 1: 1B15   | 0            | 11: _____ | _____        |
| 2: 1B16   | 1            | 12: _____ | _____        |
| 3: 1B17   | 2            | 13: _____ | _____        |
| 4: _____  | _____        | 14: _____ | _____        |
| 5: _____  | _____        | 15: _____ | _____        |

Screen 7-2. Signaling Group form (Group 1) — D-channel Backup, Three DS1 Interfaces

Page 1 of 1

SIGNALING GROUP

Group Number : 2      Associated Signaling? n      Max number of NCA TSC: 0  
                                 Primary D-Channel: 1B1824      Max number of CA TSC: 0  
                                 Secondary D-Channel: \_\_\_\_\_      Trunk Group for NCA TSC: \_\_\_  
                                 Trunk Group for Channel Selection: \_\_\_\_\_

| Trunk Brd | Interface ID | Trunk Brd | Interface ID |
|-----------|--------------|-----------|--------------|
| 1: 1B17   | 0            | 11: _____ | _____        |
| 2: 1B18   | 1            | 12: _____ | _____        |
| 3: _____  | _____        | 13: _____ | _____        |
| 4: _____  | _____        | 14: _____ | _____        |
| 5: _____  | _____        | 15: _____ | _____        |

Screen 7-3. Signaling Group form (Group 2) — No D-channel Backup, Two DS1 Interfaces

Page 1 of 1

SIGNALING GROUP

Group Number : 3      Associated Signaling? y      Max number of NCA TSC: 0  
                                 Primary D-Channel: 1B1924      Max number of CA TSC: 0  
                                 Trunk Group for NCA TSC: \_\_\_  
                                 Trunk Group for Channel Selection: \_\_\_\_\_

Screen 7-4. Signaling Group form (Group 3) — Facility Associated Signaling

Note that in [Screen 7-2](#), [Screen 7-3](#) and [Screen 7-4](#):

- Signaling Group 1 B-channels on DS1 circuit packs (boards) B0 and B1 are signaled by D-channel pair B1524 (see Primary D-channel field) and B1624 (see Secondary D-channel field).
- Signaling Group 2 B-channels on board B1 are signaled by D-channel B1824.
- Board B0 has no D-channel. The B-channels on board B0 can be signaled by either D-channel pair B1524/B1624 (Signaling Group 1) or D-channel B1824 (Signaling Group 2).
- The DS1 interface on board B19 (Signaling Group 3) is a Facility Associated Signaling case. Note that Secondary D-channel and Trunk Board/Interface ID are not displayed when Associated Signaling is y.

The following 2 communications-interface forms must be completed for the ISDN-PRI interface on R5vs/si and later configurations if the D-channel is switched through the TN765 Processor Interface (PI) circuit pack:

- Interface Links form — Used to create an association between the D-channel on a DSI circuit pack and the port on a TN765 Processor Interface circuit pack used for this link.
- Processor Channels form — Used to assign processor channels to the link administered on the Interface Links form.

Finally, trunk ports are added to the ISDN-PRI trunk group and to Signaling Groups.

Page Y of X

TRUNK GROUP

Administered Members (min/max): xxx/yyy  
 Total Administered Members: xxx

GROUP MEMBER ASSIGNMENTS

| Port       | Code  | Sfx   | Name  | Night | Sig Grp |
|------------|-------|-------|-------|-------|---------|
| 1: 1B1501  | _____ | _____ | _____ | _____ | -       |
| 2: 1B1523  | _____ | _____ | _____ | _____ | -       |
| 3: 1B1601  | _____ | _____ | _____ | _____ | -       |
| 4: 1B1623  | _____ | _____ | _____ | _____ | -       |
| 5: 1B1701  | _____ | _____ | _____ | _____ | 1       |
| 6: 1B1709  | _____ | _____ | _____ | _____ | 1       |
| 7: 1B1716  | _____ | _____ | _____ | _____ | 2       |
| 8: 1B1724  | _____ | _____ | _____ | _____ | 2       |
| 9: 1B1801  | _____ | _____ | _____ | _____ | -       |
| 10: 1B1823 | _____ | _____ | _____ | _____ | -       |
| 11: 1B1901 | _____ | _____ | _____ | _____ | -       |
| 12: 1B1923 | _____ | _____ | _____ | _____ | -       |
| 13: _____  | _____ | _____ | _____ | _____ | -       |
| 14: _____  | _____ | _____ | _____ | _____ | -       |
| 15: _____  | _____ | _____ | _____ | _____ | -       |

**Screen 7-5. ISDN-PRI Trunk Group form — Trunk Members with Required Signaling Group**

The Sig Grp column on the above trunk group form is completed as follows:

- If a DS1 interface appears in one and only one Signaling Group, then Sig Grp may be left blank because the system automatically populates the field with the correct Signaling Group.
- If a DS1 circuit pack appears in more than one Signaling Group, then the Signaling Group numbers must be entered in the appropriate fields before submitting the form.

## **Interactions**

---

Non-Facility Associated Signaling is not supported with ISDN-BRI trunks.

## Wideband Switching

---

Wideband Switching provides the ability to dedicate 2 or more ISDN-PRI B-channels or DS0 endpoints for applications that require large bandwidth. It provides high-speed end-to-end connectivity between endpoints where dedicated facilities are not economic or appropriate.

### How to administer Wideband Switching

---

#### Required forms

---

| Form                                 | Field | Page                  |
|--------------------------------------|-------|-----------------------|
| Access Endpoint                      | ■ All | <a href="#">7-72</a>  |
| PRI Endpoint                         | ■ All | <a href="#">7-102</a> |
| ISDN-PRI Trunk Group                 | ■ All | <a href="#">7-219</a> |
| Route Pattern                        | ■ All | <a href="#">8-67</a>  |
| Fiber Link Administration (optional) | ■ All | <a href="#">5-146</a> |

### Detailed description

---

ISDN-PRI divides a T1 or E1 trunk into 24 (31 for E1) information channels and one signaling channel for standard narrowband communication. Certain applications, like video conferencing, require greater bandwidth. You can combine several narrowband channels into one wideband channel to accommodate the extra bandwidth requirement. DEFINITY ECS serves as a gateway to many types of high-bandwidth traffic. In addition, DS1 converters (TN1654) are used for wideband switching at remote locations.

Wideband Switching supports:

- High-speed video conferencing
- WAN disaster recovery
- Scheduled batch processing (for example, nightly file transfers)
- LAN interconnections and imaging
- Other applications involving high-speed data transmission, video transmission, or high bandwidth

[Table 7-5](#) provides information on Wideband Switching channel types.

**Table 7-5. Wideband switching channel types**

| Channel Type | Number of Channels | Data Rate     |
|--------------|--------------------|---------------|
| H0           | 6                  | 384 Kbps      |
| H11          | 24                 | 1536 Kbps     |
| H12          | 30                 | 1920 Kbps     |
| NXDS0 (T1)   | 2-24               | 128–1536 Kbps |
| NXDS0 (E1)   | 2-31               | 128–1984 Kbps |

## Channel allocation

Perform wideband-channel allocation using one of three allocation algorithms: fixed, flexible, or floating.

- Fixed allocation — Provides contiguous-channel aggregation. The starting channel is constrained to a predetermined starting point. (Used only for H0, H11, and H12 calls.)
- Flexible allocation — Allows a wideband call to occupy noncontiguous positions within a single T1 or E1 facility.
- Floating allocation — Enforces contiguous-channel aggregation. The starting channel is not constrained to a predetermined starting point.

## Typical uses

A typical video application uses an ISDN-PRI interface to DS0 1 through 6 of the line-side facility. See to [Figure 7-7](#).

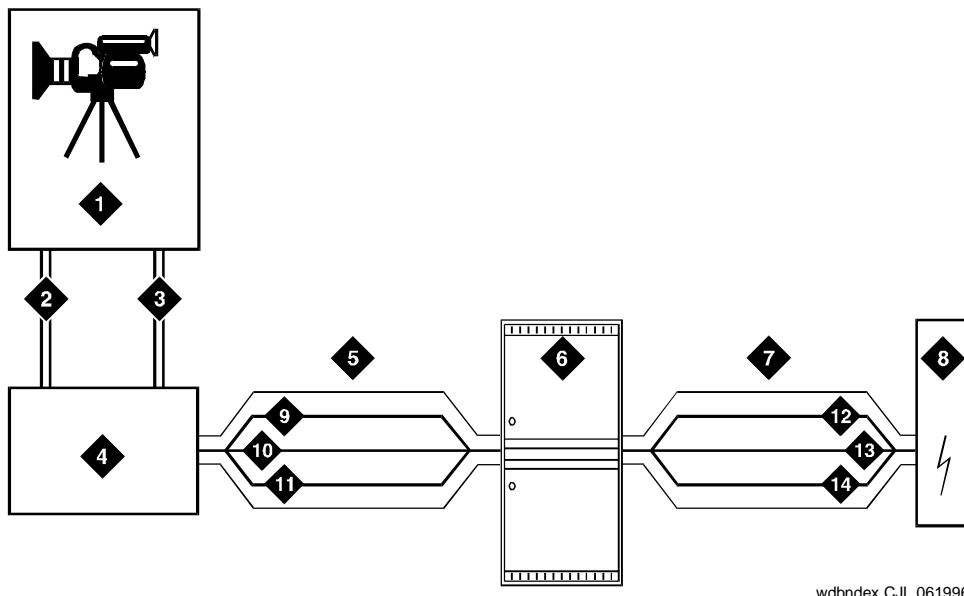

wdbndex CJL 061996

**Figure Notes**

- |                          |                           |
|--------------------------|---------------------------|
| 1. Video application     | 8. Network                |
| 2. Port 1                | 9. DS0 24 D-channel       |
| 3. Port 2                | 10. DS0 23 unused         |
| 4. ISDN terminal adaptor | 11. DS0 1-6 wideband      |
| 5. Line-side ISDN-PRI    | 12. DS0 24 D-channel      |
| 6. DEFINITY ECS          | 13. DS0 7-23 narrow bands |
| 7. ISDN trunk            | 14. DS0 1-6 wideband      |

**Figure 7-7. Wideband Switching Video Application**

**Endpoint applications**

An endpoint application is the origination or destination point of a wideband call. Endpoint applications can be any number of data applications based on the customer's particular needs.

**ISDN-PRI terminal adapters**

ISDN-PRI terminal adapters translate standard ISDN signaling into a form that can be used by the endpoint application and vice versa. The terminal adapter also must adhere to the PRI-endpoint boundaries as administered on the DEFINITY ECS switch when handling both incoming (to the endpoint) applications and outgoing calls.



The terminal adapter passes calls to and receives calls from the line-side ISDN-SETUP messages indicating the data rate and specific B-channels (DS0) to be used and communicates all other call status information via standard ISDN messages. See the *DEFINITY Line-Side ISDN Primary Rate Interface Technical Reference* for more information.

### **Line-side (T1 or E1) ISDN-PRI facility**

A line-side ISDN-PRI (T1 or E1) facility is comprised of a group DS0s (24 for a T1 facility and 32 for an E1 facility). In this context, these DS0s are also called channels. There are 23 B-channels and a single D-channel for a T1 facility and 30 B-channels and a single D-channel for an E1 facility. Data flows bi-directionally across the facility between the switch and the ISDN-PRI terminal adapter.

### **PRI-endpoints**

A PRI-endpoint (PE) is a combination of DS0 B-channels on a line-side T1 or E1 ISDN-PRI facility that has been assigned an extension.

A PRI-endpoint can support calls of lower bandwidth. In other words, a PE having a width 6 (six DS0s) can handle a call of one channel (64 Kbps) up to and including six channels (384 Kbps). Also, a PE can support calls on non-adjacent channels. For example, an endpoint application connected to a PE defined as using B-channels 1 through 6 of an ISDN-PRI facility could originate a call using B-channels 1, 3, and 5 successfully. If the PE has been administered to use flexible channel allocation, the algorithm for offering a call to the PE starts from the first DS0 administered to the PE. Since only one active call is permitted on a PE, contiguous B-channels are always selected unless one or more B-channels are not in service.

A PE remains in service unless all of its B-channels are out of service. In other words, if B-channel 1 is out of service and the PE is five B-channels wide, a wideband call of up to four B-channels in width could still be handled by the PE. A PE can only be active on a single call at any given time, that is, it is either considered idle, active (busy), or out of service.

One facility can support multiple separate and distinct PRI-endpoints (several extensions) within a single facility. Non-overlapping contiguous sets of DS0s (B-channels) are associated with each PE.

### **Universal digital signal level 1 board**

The UDS1 board is the interface for line-side and network facilities carrying wideband calls. The board is a TN464C or later circuit pack.

## **Non-signaling configuration**

Wideband can also support configurations using non-signaling (non-ISDN-PRI) line-side T1 or E1 facilities. The endpoint applications are the same as those defined for configurations with signaling.

## Data service unit/channel service unit

This unit simply passes the call to the endpoint application. Unlike terminal adapters, the DSU/CSU does not have a signaling capability.



### NOTE:

No DSU/CSU is needed if the endpoint application has a fractional T1 interface.

## Line-side (T1 or E1) facility

This facility, like the ISDN-PRI facility, is composed of a group of DS0s (24 for a T1 facility and 31 for an E1 facility). Line-side facilities are controlled solely from the switch. Through the access-endpoint command, a specific DS0 or group of DS0s is assigned an extension. This individual DS0 or group, along with the extension, is known as a wideband access endpoint (WAE).

## Wideband access endpoint

WAEs have no signaling interface to the switch. These endpoints simply transmit and receive wideband data when the connection is active.



### NOTE:

The switch can determine if the connection is active, but this does not necessarily mean that data is actually coming across the connection.

A WAE is treated as a single endpoint and can support only one call. If all DS0s comprising a wideband access endpoint are in service, then the wideband access endpoint is considered in service. Otherwise, the wideband access endpoint is considered out of service. If an in-service wideband access endpoint has no active calls on its DS0s, it is considered idle. Otherwise, the wideband access endpoint is considered busy.

Multiple WAEs are separate and distinct within the facility and endpoint applications must be administered to send and receive the correct data rate over the correct DS0s. An incoming call at the incorrect data rate is blocked.

## Guidelines and examples

---

This section examines wideband and its components in relation to the following specific customer usage scenarios:

- High-speed video conferencing
- Data backup connection
- Scheduled batch processing
- Primary data connectivity
- Networking

## High-speed video conferencing

All data rates are multiples of 64 Kbps; from 128 Kbps to 1,536 Kbps (T1) and 1,984 Kbps (E1) are supported. Key customer data rates are listed in [Table 7-5](#).

## Data backup connection

Using wideband for data transmission backup provides customers with alternate transmission paths for critical data in the event of primary transmission path failure.

### Scheduled batch processing

Scheduled batch processing applications are used for periodic database updates (for example, retail inventory) or distributions (for example, airline fare schedules). These updates are primarily done after business hours and are often referred to as nightly file transfers. Wideband meets the high bandwidth requirements at low cost for scheduled batch processing. In addition, wideband allows the dedicated-access bandwidth for busy-hour switch traffic to be used for these applications after business hours; no additional bandwidth costs are incurred.

The non-ISDN backup data connection is also appropriate for scheduled batch processing applications. Administered Connections are used to schedule daily or weekly sessions originating from this application.

### Primary data connectivity

Permanent data connections (those always active during business hours), such as interconnections between LANs, are well suited for DEFINITY ECS when ISDN-PRI endpoints are used. The ISDN end-to-end monitoring and the endpoint's ability to react to failures provide for critical data availability needs. With ISDN, endpoints can detect network failures and initiate backup connections through the switch; ISDN endpoints can also establish additional calls when extra bandwidth is needed.

Any failures not automatically restored by DEFINITY ECS are signaled to the endpoint application, which can initiate backup data connections over the same PRI endpoint. DEFINITY ECS routes the backup data connections over alternate facilities if necessary.

## Networking

All of the wideband networking is over ISDN-PRI facilities but may connect to a variety of networks, other domestic interexchange carriers' services, private line, RBOC services, and services in other countries.

## ISDN-PRI trunk groups and channel allocation

---

Only ISDN-PRI trunks support wideband calls to the network. Wideband's bandwidth requirements have necessitated modification of the algorithms by which trunks look for clear channels. The following section describes the search methods and their relationship to the available wideband data services.

### Facility lists

A wideband call accessing the network must reside on a single ISDN-PRI facility. Trunks within a trunk group must be organized based on the facility on which they reside. This is accomplished by compiling a facility list as trunks are administered to a trunk group; if a trunk is added to a trunk group from a facility not already on that trunk group's list, that facility is added to the list in an order based on the facility's signaling group number and interface identifier. In other words, the facility list is compiled in an ascending order based first on signaling group number and second on the interface identifier assigned to the facility within the signaling group. For example, if three facilities having signaling group/interface identifier combinations of 1/1, 1/2, and 2/1 were associated with a trunk group, then a call offered to that trunk group would search those facilities in the order as they were just listed. Also note that since trunks within a given facility can span several trunk groups, a single facility can be associated with several different trunk groups.

Given this facility list concept, the algorithms have the ability to search for trunks, by facility, in an attempt to satisfy the bandwidth requirements of a given wideband call. If one facility does not have enough available bandwidth to support a given call, or it is not used for a given call due to the constraints presented in the following section, then the algorithm searches the next facility in the trunk group for the required bandwidth (if there is more than one facility in the trunk group).

In addition to searching for channels based on facilities and required bandwidth, Port Network (PN) preferential trunk routing is also employed. This PN routing applies within each algorithm at a higher priority than the constraints put on the algorithm by the parameters listed later in this section. In short, all facilities that reside on the same PN as the originating endpoint are searched in an attempt to satisfy the bandwidth of a given call, prior to searching any facilities on another PN.

### Direction of trunk/hunting within facilities

The algorithms have the ability to select trunks from low B-channel to high B-channel or from high B-channel to low B-channel with an ISDN facility. This is a per ISDN trunk group option, but infers the direction of search within all ISDN facilities (or portions of those facilities) administered within that trunk group. This is necessary so the selection of trunks are not prone to as much glare as they otherwise would be if trunks were chosen in the same direction by both user and

network sides of the ISDN interface. Note that in previous DEFINITY ECS releases, the order in which trunks were selected, whether through linear or circular hunting, would always be with respect to the order in which trunks were administered within the trunk group. Now, with the support of wideband services, all trunks within an ISDN trunk group optioned for wideband are ordered based on this new "direction of trunk/hunt with facilities" parameter, and without regard to the order in which trunks are administered within the trunk group. If an ISDN trunk group is not optioned for wideband, then a cyclical trunk hunt based on the administration of trunks within the trunk group is still available.

## H11

When a trunk group is administered to support H11, the algorithm to satisfy a call requiring 1,536 Kbps of bandwidth uses a fixed allocation scheme. That is, the algorithm searches for an available facility using the following facility-specific channel definitions.

- T1: H11 can only be carried on a facility without a D-channel being signaled in an NFAS arrangement (B-channels 1-24 are used).
- E1: Although the 1,536-kbps bandwidth could be satisfied using a number of fixed starting points (for example, 1, 2, 3, etc.) the only fixed starting point being supported is 1. Hence, B-channels 1–15 and 17–25 are always used to carry an H11 call on an E1 facility.

If the algorithm cannot find an available facility within the trunk group that meets these constraints, then the call is blocked from using this trunk group. In this case, the call may be routed to a different trunk group preference via Generalized Route Selection (GRS), at which time, based on the wideband options administered on that trunk group, the call would be subject to another hunt algorithm (that is, either the same H11 algorithm or perhaps an N x DS0 algorithm described in a later paragraph).

This same hunt algorithm, when offered any other call (other than a 1,920-kbps call) attempts to preserve idle facilities by selecting trunk(s) in a partially contaminated facility if one exists. If the bandwidth required by this call cannot be satisfied by any partially contaminated facility, then the call is placed on available trunk(s) within an idle facility, thus contaminating the facility. Again, facilities are selected via the trunk group's facility list and with PN preference, and trunk(s) within a facility are selected based on the direction of channel search administered. Note that on a T1 facility, a D-channel is not considered a busy trunk and results in a facility with a D-channel always being partially contaminated. On an E1 facility, however, a D-channel is not considered a busy trunk because H11 and H12 calls may still be placed on that facility; an E1 facility with a D-channel and idle B-channels is considered an idle facility.

## H12

Since H12 is 1,920 Kbps which is comprised of 30 B-channels, a 1,920-kbps call can only be carried on an E1 facility. As with H11, the hunt algorithm uses a fixed allocation scheme with channel 1 being the fixed starting point. Hence, an H12 call always is carried on B-channels 1 to 15 and 17 to 31 on an E1 facility (as illustrated in the following table). When offered any other call (other than a 1,536-kbps call), the algorithm behaves as it does when H11 is optioned.

| Facility | ISDN Interface | DS0s Comprising Each Channel |             |
|----------|----------------|------------------------------|-------------|
|          |                | H11                          | H12         |
| T1       | 23B + D        | -                            | -           |
| T1       | 24B (NFAS)     | 1-24                         | -           |
| E1       | 30B + D        | 1-15, 17-25                  | 1-15, 17-31 |
| E1       | 31B (NFAS)     | 1-15, 17-25                  | 1-15, 17-31 |

## H0

When a trunk group is administered to support H0, the algorithm to satisfy a call requiring 384 Kbps of bandwidth also uses a fixed allocation scheme. Unlike the H11 fixed scheme which only supports a single fixed starting point, the H0 fixed scheme supports four (T1) or five (E1) fixed starting points. The H0 algorithm searches for an available quadrant within a facility based on the direction of trunk or hunt administered. If the algorithm cannot find an available quadrant within any facility allocated to this trunk group, then the call is blocked from using this trunk group. Again, based on GRS administration, the call may route to a different trunk group preference and be subject to another algorithm based on the wideband options administered.

This same trunk or hunt algorithm, when offered any narrowband or N x DS0 call, attempts to preserve idle quadrants by choosing a trunk(s) in a partially contaminated quadrant if one exists. If a partially contaminated quadrant capable of carrying the call does not exist, then the call is placed on available trunk(s) within an idle quadrant, thus contaminating the quadrant. Again, facilities are selected via the trunk group's facility list and with PN preference, and a trunk(s) within a facility is selected based on the direction administered. Note that a D-channel is considered a busy trunk and results in the top most quadrant of a T1, B-channels 19 to 24, always being partially contaminated. This is *not true* for NFAS.

If this H0 optioned trunk group is also administered to support H11, H12, or N x DS0, then this algorithm also attempts to preserve idle facilities. In other words, when offered a narrowband, H0, or N x DS0 call, the algorithm searches partially-contaminated facilities before it searches to idle facilities.

## N x DS0

For the N x DS0 multi-rate service, a trunk group parameter determines whether a floating or a flexible trunk allocation scheme is to be used. The algorithm to satisfy an N x DS0 call is either floating or flexible.

- Floating (Contiguous) — In the floating scheme, an N x DS0 call is placed on a contiguous group of B-channels large enough to satisfy the requested bandwidth without any constraint being put on the starting channel (that is, no fixed starting point trunk).
- Flexible — In the flexible scheme, an N x DS0 call is placed on any set of B-channels as long as the requested bandwidth is satisfied. There is absolutely no constraint such as contiguity of B-channels or fixed starting points. Of course, as with all wideband calls, all the B-channels comprising the wideband call must reside on the same ISDN facility.

Regardless of the allocation scheme employed, the N x DS0 algorithm, like the H11 and H12 algorithms, attempts to preserve idle facilities when offered B, H0, and N x DS0 calls. This is important so that N x DS0 calls, for large values of N, have a better chance of being satisfied by a given trunk group. However, if one of these calls cannot be satisfied by a partially-contaminated facility and an idle facility exists, a trunk on that idle facility is selected, thus contaminating that facility.

There are additional factors to note regarding specific values of N and the N x DS0 service:

- N = 1 — this is considered a narrowband call and is treated as any other voice or narrowband-data (B-channel) call.
- N = 6 — if a trunk group is optioned for both H0 and N x DS0 service, a 384-kbps call offered to that trunk group is treated as an H0 call and the H0 constraints apply. If the H0 constraints cannot be met, then the call is blocked.
- N = 24 — if a trunk group is optioned for both H11 and N x DS0 service, a 384-kbps call offered to that trunk group is treated as an H0 call and the H0 constraints apply. If the H0 constraints cannot be met, then the call is blocked.
- N = 24 — if a trunk group is optioned for both H11 and N x DS0 service, a 1,536-kbps call offered to that trunk group is treated as an H11 call and the H11 trunk allocation constraints apply.
- N = 30 — if a trunk group is optioned for both H12 and N x DS0 service, a 1,920-kbps call offered to that trunk group is treated as an H12 call and the H12 trunk allocation constraints apply.

## Glare and blocking

---

### Glare prevention

Glare occurs when both sides of an ISDN interface select the same B-channel for call initiation. For example, a user side of an interface selects the B-channel for an outgoing call and, before the switch receives and processes the SETUP message, the switch selects the same B-channel for call origination. Since wideband uses more channels, the chances of glare are greater. Glare conditions can be limited with proper channel administration but may never be eliminated and some calls might still be dropped.

Some glare situations might not be resolvable. In one case, the network and the user side may send SETUP messages simultaneously or nearly simultaneously. Another glare scenario can occur in the brief window after the SETUP message has been sent but before the first response is received from the switch at the other side of the interface. If an incoming SETUP arrive during this window, the incoming SETUP message is allowed to proceed and the outgoing call is dropped. Various glare situations and their resolution are described in [Table 7-6](#).

DEFINITY ECS does not negotiate channels for wideband calls.

**Table 7-6. Handling Glare**

| GLARE RESOLUTION   |                    |   |  |
|--------------------|--------------------|---|--|
| Outgoing Call Type | Incoming Call Type | Switch-Supporting User Protocol   | Switch-Supporting Network Protocol   |
| B-channel          | B-channel          | No negotiation<br>Incoming call (from network) wins   | Negotiation is attempted<br>Incoming call (from user) dropped if negotiation is unsuccessful   |
|                    |                    | Outgoing call (to network) retried on another trunk   | Outgoing call (to user) stays up   |
| B-channel(s)       | Wide               | No negotiation  | No negotiation   |
|                    |                    | Incoming call (from network) dropped  | Incoming call (from user) dropped  |
|                    |                    | Outgoing calls (to network) stay up but likely are dropped by network because channels are in use, although there is a possibility some switches might negotiate these calls. | Outgoing calls (to user) stay up and possibly stay up if other side lets the network call win. |

*Continued on next page*



Table 7-6. Handling Glare — *Continued*

| GLARE RESOLUTION   |                    |  |  |
|--------------------|--------------------|--|--|
| Outgoing Call Type | Incoming Call Type | Switch-Supporting User Protocol  | Switch-Supporting Network Protocol   |
| Wide               | B-channel(s)       | No negotiation   | Negotiation is attempted   |
|                    |                    | Incoming call (from network) wins  | Incoming call (from user) dropped if negotiation is unsuccessful   |
|                    |                    | Outgoing call (to network) retried on another trunk  | Outgoing call (to user) stays up   |
| Wide               | Wide               | No negotiation   | No negotiation   |
|                    |                    | Incoming call (from network) dropped   | Incoming call (from user) dropped  |
|                    |                    | Outgoing call (to network) stays up but likely are dropped by network because channels are in use. | Outgoing call (to user) stays up and may not be dropped by other side because other side, if it is not a DEFINITY ECS, may let the network call win. |

To reduce glare probability, the network needs to be administered so both sides of the interface select channels from opposite ends of facilities. For example, on a 23B+D trunk group, the user side could be administered to select B-channels starting at channel 23 while the network side would be administered to start selecting at channel 1. Using the same example, if channel 22 is active but channel 23 is idle, the user side should select channel 23 for re-use. This is known as linear trunk hunt and is the hunt option used by DEFINITY ECS for wideband.

### Blocking prevention

Blocking occurs when insufficient B-channels required to make a call are available. Narrowband calls require only one channel so blocking is less likely than with wideband calls which require multiple B-channels. Blocking also occurs for wideband calls when bandwidth is not available in the appropriate format (that is, fixed, floating, or flexible).

DEFINITY ECS selects trunks for both wideband and narrowband calls to maximize availability of idle fixed channels for H0, H11, and H12 calls and idle floating channels for N x DS0 calls that require a contiguous bandwidth. The strategy for preserving idle channels to minimize blocking depends on the channel type.

| Channel Type   | Blocking Minimization Strategy             |
|----------------|--|
| H0             | Preserve idle quadrants                    |
| H11            | Preserve idle facilities                   |
| H12            | Preserve idle facilities                   |
| Flexible NxDS0 | Preserve idle facilities                   |
| Floating NxDS0 | Preserve idle facilities as first priority |

## Considerations

---

- Glare arises when both sides of an ISDN-PRI interface simultaneously select the same B-channel for call initiation. Because Wideband Switching uses multiple B-channels, the possibility of glare is greater than it is with other calls.
- To reduce glare, administer the system so that each side of the ISDN-PRI interface selects channels from opposite ends of the interface.
- For wideband switching with non-ISDN-PRI equipment, you can use an ISDN-PRI terminal adapter.
- For example, if the user side is provisioned to start at the high side (DS0 23) and DS0 22 is idle but DS0 23 is active, reselect DS0 22 for the next call. This is known as linear trunk hunting. Only the direction of hunt is administrable.
- Blocking occurs when not enough bandwidth is available for a call.
- To reduce blocking, the switch selects trunks to maximize availability of idle fixed channels for H0, H11, and H12 calls and idle floating channels for NxDS0 calls. The strategy depends on the channel type. The chances for blocking are reduced if you use a flexible algorithm, assuming it is supported on the other end.

## Interactions

---

- Administered Connections  
Provides call initiation for WAEs. All Administered Connections that originate from WAEs use the entire bandwidth administered for WAE. The destination of an Administered Connection can be a PRI endpoint.
- Automatic Circuit Assurance  
Treats wideband calls as single-trunk calls so that a single ACA-referral call is made if an ACA-referral call is required. The call is on the lowest B-channel associated with the wideband call.

- Call Coverage

A wideband endpoint extension cannot be administered as a coverage point in a call-coverage path.
- Call Detail Recording

When CDR is active for the trunk group, all wideband calls generate CDR records. The feature flag indicates a data call and CDR records contain bandwidth and Bearer Capability Class (BCC).
- Call Forwarding

You must block Call Forwarding through Class of Service.
- Call Management System and Basic Call Management System

Wideband calls can be carried over trunks that are measured by CMS and BCMS. Wideband endpoints are not measured by CMS and BCMS.
- Call Vectoring

PRI endpoints use a vector-directory number when dialing. For example, PRI endpoint 1001 dials VDN 500. VDN 500 points to Vector 1. Vector 1 can point to other PRI endpoints such as route-to 1002, or route-to 1003, or busy.

Call Vectoring is used by certain applications. When an incoming wideband call hunts for an available wideband endpoint, the call can route to a VDN, that sends the call to the first available PRI endpoint.
- Class of Restriction

COR identifies caller and called-party privileges for PRI endpoints. Administer the COR so that account codes are not required. Forced entry of account codes is turned off for wideband endpoints.
- Class of Service

COS determines the class of features that a wideband endpoint can activate.
- Facility and Non-Facility Associated Signaling

FAS and NFAS with or without D-Channel Backup requires administration via signaling groups for trunk-side wideband interfaces.
- Facility Busy Indication

You can administer a busy-indicator button for a wideband-endpoint extension, but the button does not accurately track endpoint status.
- Facility Test Calls

Use Facility Test Calls to perform loop-back testing of the wideband call facility.
- Fiber Link Administration

Use Fiber Link Administration for adding remote locations.

- Generalized Route Selection

GRS supports wideband BCC to identify wideband calls. GRS searches a route pattern for a preference that has wideband BCC. Route preferences that support wideband BCC also support other BCCs to allow different call types to share the same trunk group.

- Subnet Trunking

Accomplish Subnet Trunking via GRS and routing pattern administration.

- Wideband Switching

Not supported with ISDN-BRI trunks.

## **Trunk Group Administration Forms**

This section contains the following Trunk Group Administration forms.

- Access Endpoint
- ATMS Trunk Test Schedule
- DS1 Circuit Pack
- Digit Absorption
- ISDN Numbering — Private
- ISDN Numbering — Public/Unknown
- ISDN TSC Gateway Channel Assignments
- Network-Facilities
- PRI Endpoint
- Signaling Group
- Synchronization Plan
- Trunk Groups — General
- Access trunk group
- APLT trunk group
- CAMA - E911 trunk group
- CO trunk group
- CPE trunk group
- DID trunk group
- DIOD trunk group
- DMI-BOS trunk group
- FX trunk group
- ISDN-BRI trunk group
- ISDN-PRI trunk group
- PCOL trunk group
- RLT trunk group
- Tandem trunk group
- Tie trunk group
- WATS trunk group

## Access Endpoint

---

This form administers Access Endpoints and Wideband Access endpoints.

### ⇒ NOTE:

You can administer Wideband Access Endpoints only if Wideband Switching is enabled on the System-Parameters Customer-Options form.

An Access Endpoint is a nonsignaling trunk that neither responds to signaling nor generates signaling. Access Endpoints eliminate the need to dedicate an entire trunk group for the access of a single trunk by providing the capability to assign an extension number to a single trunk. An Access Endpoint can be specified as the Originator or Destination endpoint of an administered connection.

A Wideband Access Endpoint (WAE) is an endpoint application connected to line-side non-ISDN T1 or E1 facilities and, like Access Endpoints, have no signaling interface with the system. For information on endpoint applications connected to line-side ISDN-PRI facilities, see [“PRI Endpoint” on page 7-102](#).

The WAE is defined by a starting port (DS0) and a width specifying the number of adjacent nonsignaling DS0s (positioned within a DS1 facility) that make up the endpoint. This width may be between 2 and 31 adjacent DS0s.

### ⇒ NOTE:

Access Endpoints and Wideband Access Endpoints consume the same resources that trunks use. Thus, the sum of Access Endpoints and trunks cannot exceed the maximum number of trunks available in your system configuration.

## Administration commands

---

Use the following commands to administer the Access Endpoint form

| Action    | Object          | Qualifier <sup>1</sup>                        |
|-----------|-----------------|---|
| add       | access-endpoint | xxxx (ext. or 'next')                         |
| change    | access-endpoint | xxxx (ext. or 'next')                         |
| display   | access-endpoint | xxxx (ext. or 'next') ['print' or 'schedule'] |
| duplicate | access-endpoint | xxxx (ext. or 'next')                         |
| remove    | access-endpoint | xxxx (ext. or 'next')                         |
| list      | access-endpoint | xxxx ['count' 1-MAX] ['print' or 'schedule']  |

1. Brackets [ ] indicate the qualifier is optional. Single quotes ( ' ' ) indicate the text inside the quote must be entered exactly as shown or an abbreviated form of the word may be entered. MAX is the maximum number available in your system configuration.

## Form instructions

```

add access-endpoint next                                Page 1 of 1
                                ACCESS ENDPOINT
                                Extension: 30001      (Starting) Port:
Communication Type: voice-grade-data                   Name: 27 character name ext 30001
                                COR: 1                  COS: 1
                                TN: 1                   ITC: restricted
    
```

### Screen 7-1. Access Endpoint form

- **Extension** — Display-only field. Shows the extension number as specified in the command line, or shows the next available extension number if "next" was entered on the command line. This is the extension number assigned to the nonsignaling trunk and used to access the trunk endpoint.
- **(Starting) Port** — Enter seven characters.

The entry breaks down as follows:

| Characters | Meaning        | Value   |
|------------|----------------|---|
| 1-2        | Cabinet Number | 01 through 44 (R5r and later configurations)<br>01 through 03 (R5si and later configurations)<br>01 (R5vs and later configurations) |
| 3          | Carrier        | A through E   |
| 4-5        | Slot Number    | 01 through 20   |
| 6-7        | Circuit Number | 01 through 04 (Analog TIE trunks)<br>01 through 31 (DS1 Interface ports)  |

#### NOTE:

For Wideband Access Endpoints, analog tie trunks cannot be used and the TN464C (or greater) DS1 circuit pack must be used.

The DS1 circuit number corresponds to the channel that will carry the data traffic. Channels 1 through 31 (TN464 only) or channels 1 through 24 (TN722, TN767, or TN464) may be used when the DS1 Signaling Type is

"robbed-bit" or "isdn-ext". For Common Channel or ISDN-PRI signaling, channel use is limited to channels 1 through 30 (TN464 only) or channels 1 through 23 (TN464 or TN767). A channel can be administered as an access endpoint regardless of the DS1 signaling type.

- **Communication Type** — For an analog tie trunk access endpoint, enter **voice-grade-data**. For a DS1 access endpoint, enter either **56k-data**, **64k-data**, or **voice-grade-data** (default) as appropriate (**64k-data** is not allowed for robbed-bit trunks). For a Wideband access endpoint, enter **wideband**.
- **Name** — Enter up to 27 alphanumeric characters to identify the endpoint. Default is blank.
- **Width** — Only displays if `Communication Type` is **wideband**. Enter the number of adjacent DS0 ports (**2 to 31**), beginning with the specified Starting Port, that make up the WAE. A width of **6** (default) defines a 384 Kbps WAE. This field cannot be blank.
- **COR** — Enter the appropriate class of restriction (COR) number from **0–95**. The COR is administered so that only an administered connection (AC) endpoint can be connected to another AC endpoint. Default is **1**.
- **COS** — Enter the appropriate COS number from **0–15**. The COS is administered (see COS form instructions) so that the use of the Call Forwarding All Calls feature for access endpoints is prohibited. Default is **1**.
- **TN** — Enter the Tenant Partition number. Default is **1**.
- **ITC** — (Information Transfer Capability) Displays when `Communication Type` is **56k-data**, **64k-data**, or **Wideband**. Valid entries are **restricted** (default) or **unrestricted**. This field is used to determine the type of transmission facilities to be used for ISDN calls originating from this endpoint.

When **unrestricted**, only unrestricted transmission facilities (b8zs) will be used to complete the call. An unrestricted facility is a transmission facility that does not enforce 1's density digital transmission (that is, digital information is sent exactly as is).

When **restricted**, either restricted (zcs-ami) or unrestricted transmission facilities is used to complete the call. A restricted facility is a transmission facility that enforces 1's density digital transmission (that is, a sequence of eight digital zeros is converted to a sequence of seven zeros and a digital one) via zcs coding on DS1 circuit pack.

**NOTE:**

For Wideband Access Endpoints, enter **unrestricted**.

When adding an access endpoint with the ITC administered as **unrestricted**, its associated port has to be a channel of a DS1 circuit pack with `Zero Code Suppression` administered as **B8ZS**. If the port is not a



channel of a DS1 circuit pack with its Zero Code Suppression administered as B8ZS, the end validation fails and the form submission is rejected. The cursor is moved to ITC with the following error message:

```
An unrestricted access endpoint can only be from B8ZS  
DS1 circuit pack
```

When adding an access endpoint with the ITC administered as restricted, its associated port can be a channel from a DS1 circuit pack with Zero Code Suppression administered as ZCS or B8ZS.

For an existing access endpoint, ITC can only be changed from restricted to unrestricted if its associated port is a channel of a DS1 circuit pack with its Zero Code Suppression field administered as B8ZS. If the port is not a channel of a DS1 circuit pack with its Zero Code Suppression field administered as B8ZS, the end validation fails and the form submission is rejected. The cursor is moved to ITC with the following error message:

```
An unrestricted access endpoint can use only B8ZS DS1  
circuit pack
```

Without this end validation, a user could administer an access endpoint as unrestricted when in fact it is restricted, that is its associated port is a member of a DS1 circuit pack that uses ZCS data transmission.

## ATMS Trunk Test Schedule

---

Automatic Transmission Measurement System (ATMS) provides advanced maintenance procedures for monitoring system trunk facilities. This system performs transmission tests on system trunks to determine if trunks are performing satisfactorily. These tests can be initiated in two different manners: demand and/or scheduled. The *demand* test command can be entered by the system user directly from the System Administration Terminal (SAT) to initiate a test immediately. The *schedule* test command schedules tests, via a schedule form, to automatically initiate tests at a predetermined time.

### Administration Commands

---

Use the following commands to access the ATMS Trunk Test Schedule form.

| Action  | Object        | Qualifier <sup>1</sup>     |
|---------|---------------|----------------------------|
| add     | test-schedule | ['schedule_number'] [next] |
| change  | test-schedule | ['schedule_number']        |
| display | test-schedule | ['schedule_number']        |
| list    | test-schedule |                            |
| remove  | test-schedule | ['schedule_number']        |

- 
1. Brackets [ ] indicate the qualifier is optional. Single quotes ( ' ' ) indicate the text inside the quote must be entered exactly as shown or an abbreviated form of the word may be entered.

**Form Instructions**

Page 1 of 1

ATMS TRUNK TEST SCHEDULE

Schedule No: \_\_\_\_\_

Schedule Time: \_\_\_\_:\_\_\_\_      Schedule Test Days      Interval: \_\_\_\_\_

Schedule Date: \_\_/\_\_/\_\_      SU: \_ TU: \_ TH: \_ SA: \_      Duration: \_\_\_\_\_

OTL Throttle: \_\_\_\_\_      MO: \_ WE: \_ FR: \_      Test Type: \_\_\_\_\_

| Trk | Bgn | End | Trk | Bgn | End | Trk | Bgn | End | Trk | Bgn | End | Trk | Bgn | End |
|-----|-----|-----|-----|-----|-----|-----|-----|-----|-----|-----|-----|-----|-----|-----|
| Grp | Mem | Mem | Grp | Mem | Mem | Grp | Mem | Mem | Grp | Mem | Mem | Grp | Mem | Mem |
| —   | —   | —   | —   | —   | —   | —   | —   | —   | —   | —   | —   | —   | —   | —   |
| —   | —   | —   | —   | —   | —   | —   | —   | —   | —   | —   | —   | —   | —   | —   |
| —   | —   | —   | —   | —   | —   | —   | —   | —   | —   | —   | —   | —   | —   | —   |
| —   | —   | —   | —   | —   | —   | —   | —   | —   | —   | —   | —   | —   | —   | —   |
| —   | —   | —   | —   | —   | —   | —   | —   | —   | —   | —   | —   | —   | —   | —   |
| —   | —   | —   | —   | —   | —   | —   | —   | —   | —   | —   | —   | —   | —   | —   |
| —   | —   | —   | —   | —   | —   | —   | —   | —   | —   | —   | —   | —   | —   | —   |
| —   | —   | —   | —   | —   | —   | —   | —   | —   | —   | —   | —   | —   | —   | —   |
| —   | —   | —   | —   | —   | —   | —   | —   | —   | —   | —   | —   | —   | —   | —   |
| —   | —   | —   | —   | —   | —   | —   | —   | —   | —   | —   | —   | —   | —   | —   |
| —   | —   | —   | —   | —   | —   | —   | —   | —   | —   | —   | —   | —   | —   | —   |
| —   | —   | —   | —   | —   | —   | —   | —   | —   | —   | —   | —   | —   | —   | —   |
| —   | —   | —   | —   | —   | —   | —   | —   | —   | —   | —   | —   | —   | —   | —   |
| —   | —   | —   | —   | —   | —   | —   | —   | —   | —   | —   | —   | —   | —   | —   |
| —   | —   | —   | —   | —   | —   | —   | —   | —   | —   | —   | —   | —   | —   | —   |
| —   | —   | —   | —   | —   | —   | —   | —   | —   | —   | —   | —   | —   | —   | —   |
| —   | —   | —   | —   | —   | —   | —   | —   | —   | —   | —   | —   | —   | —   | —   |

Screen 7-2. ATMS Trunk Test Schedule Form (Page 1 of 1)

Make assignments as required for the following fields on the form.

- **Schedule** — Display-only field shows the current schedule number.
- **Schedule Time** — Enter the hour and minute that test are to begin in 24-hour time conventions. A time of "00:00" represents midnight. This time must be greater than the current time.
- **Schedule Date** — Enter the month (1 to 12), day (1 to 31), and year on which testing will begin; default is the system date. This date must be equal to or greater than the current date.
- **Schedule Test Days (SU:, MO:, TU:, WE:, TH:, FR:, SA:)** — Enter a y next to the days of the week on which this schedule will run.
- **Interval** — Enter the length of this schedule in weeks. If this field is 0 (default), the schedule runs on the specified days only once.
- **OTL Throttle** — Enter the number of concurrent tests run within a schedule. This guarantees that all trunk members within a schedule are tested serially or if multiple trunk members are tested from the same schedule.
- **Test Type** — Enter one of the following types of test to be performed on the trunk group/members in this schedule:
  - full
    - (Default) Runs the most comprehensive test and collects all associated measurements for each TTL type.

— **supv**

Performs a supervision test and will only confirm the presence of the test set at the far end. No measurements will be taken for this test.

— **no-st**

Runs the "full" test, but skips any self-test sequences. This saves about 20 seconds on the type 105 test and will not have any effect on type 100 or 102 tests.

— **no-rl**

Runs the "full" test, but skips any return loss sequences. This saves about 20 seconds on the type 105 test and will not have any effect on type 100 or 102 tests.

— **no-st/rl**

Runs the "full" test, but skips all self-test and return loss sequences. This saves about 40 seconds on the type 105 test and will not have any effect on type 100 or 102 tests.

- **Duration** — Enter the maximum number of hours (**1 to 24**) a schedule can remain active. Schedules continue to run until all trunk group/members for that particular schedule are tested or until the schedule duration is reached. If the duration is reached before all trunk groups/members can be tested, the schedule will stop.
- **Trk Grp** — Enter the trunk group numbers to be tested when this schedule runs. There is no limit to the number of times that a trunk group can appear on any particular schedule, or to the number of different schedules in which a trunk group can appear. Default is blank.
- **Bgn Mbr** — Enter the beginning member number of the trunk group to be tested; default is **1**.
- **End Mbr** — Enter the ending member number of the trunk group to be tested. This value must be greater than or equal to the value of the beginning member field.

## Implementation Note

The number of fields displayed will vary depending on system configuration. The form shown above is for R5r and later configurations.

## DS1 Circuit Pack form

See the *DEFINITY ECS System Description Pocket Reference* for information on the maximum number of DS1 circuit packs that you can administer.

### Administration commands

Use the following commands to administer the DS1 circuit pack form

| Action  | Object                   | Qualifier <sup>1</sup> |
|---------|--------------------------|------------------------|
| add     | ds1                      | [P]Css <sup>2</sup>    |
| change  | ds1                      | [P]Css(board)          |
| display | ds1                      | [P]Css                 |
| list    | measurements ds1 summary | location               |
| list    | measurements ds1 log     | location               |
| remove  | ds1                      | [P]Css                 |

1. Brackets [ ] indicate the qualifier is optional.
2. [P] — representing port network number, C — representing carrier (A-F), and ss — representing slot number.

### Field descriptions

DS1 CIRCUIT PACK

|                             |                         |
|-----------------------------|-------------------------|
| Location: _____             | Name: _____             |
| Bit Rate: _____             | Line Coding: _____      |
| Line Compensation: _        | Framing Mode: _____     |
| Signaling Mode: _____       |                         |
| Connect: _____              | Interface: _____        |
| Interconnect: _____         | Country Protocol: _____ |
|                             | Side: _                 |
| Interface Companding: _____ | CRC? _                  |
| Idle Code: _____            |                         |
| DMI-BOS? _                  |                         |

MAINTENANCE PARAMETERS

|                   |                          |
|-------------------|--------------------------|
| Slip Detection? _ | Near-end CSU Type: _____ |
|-------------------|--------------------------|

```
DS1 CIRCUIT PACK

Location: _____ Name: _____
Bit Rate: _____ Line Coding: _____
Line Compensation: _ Framing Mode: _____
Signaling Mode: _____
Connect: _____ Interface: _____
Interconnect: _____ Peer Protocol: _____
Country Protocol: _____
Protocol Version: _____
CRC? _____

Interface Companding: _____
Idle Code: _____
MMI Cabling Board: _____ DCP/Analog Bearer Capability: _____
MMI Interface: ESM

MAINTENANCE PARAMETERS

Slip Detection? _ Near-end CSU Type: _____
```

Screen 7-4. DS1 Circuit Pack form (page 1 of 1)

```
DS1 CIRCUIT PACK

Location: 01A07 Name:
Bit Rate: 1.544 Line Coding: ami-zcs
Line Compensation: 1 Framing Mode: esf
Signaling Mode: robbed-bit

Idle Code: 11111111

MAINTENANCE PARAMETERS

Slip Detection? n Near-end CSU Type: integrated
```

Screen 7-5. DS1 Circuit Pack form (page 1 of 2)

```

DS1 CIRCUIT PACK

Location: _____ Name: _____
Bit Rate: _____ Line Coding: _____

Signaling Mode: _____

Interconnect: _____ Country Protocol: _____

Interface Companding: _____
Idle Code: _____

Received Digital Metering Pulse Minimum (ms):
Received Digital Metering Pulse Maximum (ms):
Received Digital Metering Pulse Value:
Slip Detection: _____ Near-end CSU Type: _____
    
```

Screen 7-6. DS1 Circuit Pack form for Croatia and South Africa (page 1 of 1)

- **Location** — This is a 7-character display-only field when the form is accessed using an administration command such as **add** or **change**.

The entry breaks down as follows:

| Characters | Meaning        | Value   |
|------------|----------------|---|
| 1-2        | Cabinet Number | 01 through 44 (R5r and later configurations)<br>01 through 03 (R5si and later configurations)<br>01 (R5vs and later configurations) |
| 3          | Carrier        | A through E   |
| 4-5        | Slot Number    | 01 through 20   |

The location also should be identified for record purposes on the Port Assignment Record and the Circuit Pack Administration form.

- **Name** — Enter the name of the DS1 link (limit 15-characters). Typically, this is the destination of the link.
- **Bit Rate** — Enter **1.544** for the 24-channel DS1 rate. Enter **2.048** for the 32-channel E1 rate (TN464 only). Integrated CSU requires that you enter the Bit Rate of **1.544**.

 NOTE:

Once an **add ds1** operation is complete (that is, the DS1 form has been submitted) `Bit Rate` can not be changed. To change `Bit Rate`, execute a **remove ds1** command followed by an **add ds1** command, then reenter the DS1 form.

 NOTE:

The TN464C (and later release) and TN767D (and later release) circuit packs must have an option switch or plug on the circuit board set to match the `Bit Rate` selection.

- **Line Coding** — Enter **b8zs** (bipolar eight zero substitution), **ami-basic** (alternate mark inversion basic), **ami-zcs** (alternate mark inversion with zero code suppression), or **hdb3** (high density bipolar 3). The line coding method must match the method used on the other end of the link. Or, it must be converted by an intervening CSU. If line coding does not match, voice calls will work, but a single data call will bring down the DS1. The line coding entry indicates which line coding format should be used to ensure that the data meets T1 or E1 carrier requirements. When the DS1 circuit pack is used for ISDN, the ISDN D-channel data is inverted when **ami-basic** or **ami-zcs** is entered and not inverted when **b8zs** or **hdb3** is entered.

**Hdb3** or **ami-basic** is allowed when `Bit Rate` is **2.048**. **B8zs**, **ami-basic** or **ami-zcs** is allowed when `Bit Rate` is **1.544**.

Zero code suppression (`zcs`) is a technique for ensuring adequate ones density. It checks for all zeros in an 8-bit time slot. If all zeros exist, bit 2 is changed from a 0 to a 1. When `zcs` is invoked on an all zeros octet; data is lost permanently.

 CAUTION:

*If you make a change in this field, you must busyout the DS1 circuit pack. You must also change the following forms: Route-Pattern, Access Endpoint, PRI Endpoint, Signaling-Group, and Trunk-Group.*

 NOTE:

ZCS line coding is not recommended for digital-data applications.



- **Line Compensation** — Enter a number from **1** to **5** as follows:
  - For 22-gauge ABAM cable terminated on a DSX-1 cross-connect:

| Compensation | Length (feet) | Length (m) |
|--------------|---------------|------------|
| 1 (default)  | 000–133       | 000–40.5   |
| 2            | 133–266       | 40.5–81.0  |
| 3            | 266–399       | 81.0–122   |
| 4            | 399–533       | 122–163    |
| 5            | 533–655       | 163–200    |

- For 22-gauge ABAM cable directly connecting to DS1 interfaces:

| Compensation | Length (feet) | Length (m) |
|--------------|---------------|------------|
| 1 (default)  | 0000–0266     | 000–081    |
| 2            | 0266–0532     | 081–162    |
| 3            | 0532–0798     | 162–243    |
| 4            | 0798–1066     | 243–325    |
| 5            | 1066–1310     | 325–400    |

- **Framing Mode** — Enter **d4** or **esf** (default). This mode must match the method used on the other end of the link. D4 is a framing format of 12 frames for analog representation on T1 carriers using DS1 signals.
 

To get enhanced performance measurements, the framing mode must be **esf** on the DS1 Circuit Pack form. When **esf** is entered for a TN464F or TN767E or later suffix DS1 circuit pack, a second page of the DS1 Circuit Pack form becomes available to administer ESF Data Link options.
- **Signaling Mode** — Enter **CAS** (Channel Associated Signaling), **robbed-bit**, **isdn-pri**, **isdn-ext**, or **common-chan** (default). This mode must match the method used on the other end of the link.
- **Connect** — Only displays when *Signaling Mode* is **isdn-pri**. Specify what is on the far end of the PBX to control Layer 3 protocol properly. If **pbx** is entered, *Interface* displays. When **line-side** is entered, this implies that the switch is acting as the network side of the isdn-pri interface. This is used to support the Roll About Video capability. Valid entries are **network** (system default), **host**, **line-side**, and **pbx**.
- **Interface** — Only displays when *Connect* is **pbx**. Valid entries are **network**, **peer-master**, **peer-slave**, or **user** (system default). Specify whether the PBX corresponds to the network or user side of the interface, which is needed for the ISDN-PRI Layer 2 protocol, and is also used at

Layer 3 to handle glare conditions. If you are connecting to a network, your side should be **user**. If you are connecting to a host, your side should be **network**.

 **NOTE:**

When the far end is a DEFINITY ECS, the `Interface` field on one end of the connection must be `user` and the other end must be translated as `network`.

For PRI private network protocol layer 2 operations, two other values are possible: **peer-master** and **peer-slave**. Entering either of these values causes two additional fields to appear: `Peer Protocol` and `Side`.

- **Interconnect** — Enter **pbx** or **CO**. If **pbx** is selected, the trunk operates as a tie trunk. If **CO** is selected, the trunk operates as a CO or DID trunk.
- **Country Protocol** — Enter a country code or **etsi** to indicate the type of Primary Rate Interface (PRI) protocol that you want to use on this line. Your choice is determined by the country where the trunk terminates. For more information on country protocols, see [Table 7-3](#) on [7-17](#).
- **Interworking Message** — Appears if `Signaling Mode` is **isdn-pri**. Enter **PROGress** (default) or **ALERTing** to indicate whether a PROGress message or ALERTing message should be sent when interworking a call.
- **Peer Protocol** — Displays if `Interface` is **peer-master** or **peer-slave**. This allows you to administer the peer level protocol that will operate in the private network. The value **Q-SIG** is necessary for implementing QSIG Network Basic Call.

 **NOTE:**

To enter **Q-SIG**, you must have `QSIG Optional Features Basic Call Setup` enabled on the System-Related Customer-Options form.

- **Side** — Appears if `Interface` is **peer-master** or **peer-slave**. This value is used for call collision (glare) resolution at layer 3. The default value of the field changes depending upon which value `Peer Protocol` contains. The default **a** is paired with **peer-master**, and the default **b** is paired with **peer-slave**. The reason for these defaults is that logically, side a is the master at layer 3, in that side a wins the contested trunk in call collision situations. However, it is critical that this administration correctly pairs with the far-end administration. If the far-end is administered as the b side, this field should be set to a regardless of whether layer 2 designation is peer-master or peer-slave, and vice versa.
- **Interface Companding** — Enter **alaw** or **mulaw**. This field displays only if the circuit pack is a TN464C or later.
- **CRC** — Enter **y** to indicate that a cyclic redundancy check is to be performed on transmissions that the board receives.

- **Protocol Version** — Appears under the following conditions:
  - `Country` on the trunk group form is **1** (USA), **10** (UK), **12** (France), **13** (Germany), or **etsi**.



**NOTE:**

Use protocol version `c` only when the country protocol is 1 (USA).

- `Signaling Mode` is **isdn-pri**
- `Connect` is **pbx** or **network**
- `Interface` is **user** or **network**



**WARNING:**

*The AT&T Switched Network Protocol does not support restricted displays of connected numbers. Therefore, if you administer the 1a country-protocol/protocol-version combination on the DS1 form, you cannot administer Send Connected Number to r (restricted) on the ISDN-PRI Trunk Group form, as this causes display problems.*

- **Idle Code** — Enter the 8-digit string to be sent out on idle DS0 channels. The string to be entered must be compatible with the protocol of the country where the trunk terminates.
- **DMI-BOS** — Only displays when `Signaling Mode` is **common-chan**. Enter **y** (default) to activate the Digital Multiplexed Interface Bit Oriented Signaling (DMI BOS) mode.

DMI/BOS is a 24th channel signaling scheme using a DS1 facility that uses 23 message channels and 1 signaling channel (24th). DMI/BOS has greater capacity than the 24th-channel Robbed-Bit Signaling scheme. Entering **n** indicates that the DS1 provides the Lucent Technologies proprietary format; **y** indicates that the DS1/DMI interface provides the DMI format.
- **DCP/ANALOG Bearer Capability** — Displays when `Signaling Mode` is **isdn-pri**. It is used to determine bearer capability encoding. Enter **3.1kHz** (default) or **speech**.
- **MMI Cabling Board** — Enter the slot location (cabinet, carrier, slot) of the multimedia interface circuit pack that is connected to the Expansion Services Module (ESM). This field appears only if MMCH is enabled on the System-Parameters Customer-Options form.
- **MMI Interface** — A display only field that appears only if MMCH is enabled and there is a value in the MMI Cabling Board field.

- **Received Digital Metering Pulse Minimum (ms)** — Only displays when Signal Mode is **CAS** (Channel Associated Signaling), Country Protocol is **21** or **7**, and Interconnect is **co** or **tie**. This field is administerable from **20 ms** to **1000 ms** in increments of 10ms. Visible only for countries that use periodic pulse metering (PPM) as defined in [Table 7-7](#). The default is a value which depends on Country Protocol's entry. The entry for this field must be less than Received Digital Metering Pulse Maximum. [Table 7-7](#) shows the default values for this field.
- **Received Digital Metering Pulse Maximum (ms)** — Only displays when Signal Mode is **CAS** (Channel Associated Signaling), Country Protocol is **21** or **7**, and Interconnect is **co** or **tie**. This field is administerable from **20 ms** to **1000 ms** in increments of 10ms. Visible only for countries that use periodic pulse metering (PPM) as defined in [Table 7-7](#). The default is a value which depends on Country Protocol's entry. The entry for this field must be higher than Received Digital Metering Pulse Maximum. [Table 7-7](#) shows the default values for this field.
- **Received Digital Metering Pulse Value** — (Country Code 21 only) Only displays when Signal Mode is **CAS** (Channel Associated Signaling), Country Protocol is **21** or **7**, and Interconnect is **co** or **tie**. Valid entries are **0** and **1**. It defaults to a value which depends on the Country Protocol field's entry. [Table 7-7](#) shows the default values for this field.

 **NOTE:**

If Country Protocol has a value whose corresponding row in [Table 7-7](#) has only entries of "NA", then the Incoming Digital PPM fields will be blank when Country Protocol is set to that country code.

**Table 7-7. Incoming Digital PPM Signaling Default (per Country Protocol code)**

| Code | Country     | PPM Min (ms) | PPM Max (ms) | PPM Value |
|------|-------------|--------------|--------------|-----------|
| 0    | null        | NA           | NA           | NA        |
| 1    | U.S.        | NA           | NA           | NA        |
| 2    | Australia   | 80           | 180          | 0         |
| 3    | Japan       | NA           | NA           | NA        |
| 4    | Italy       | 120          | 150          | 1         |
| 5    | Netherlands | 90           | 160          | 0         |
| 6    | Singapore   | NA           | NA           | NA        |

*Continued on next page*

Table 7-7. Incoming Digital PPM Signaling Default (per Country Protocol code) — *Continued*

| Code | Country        | PPM Min (ms) | PPM Max (ms) | PPM Value |
|------|----------------|--------------|--------------|-----------|
| 7    | Mexico         | 20           | 180          | 1         |
| 8    | Belgium        | 20           | 180          | 1         |
| 9    | Saudia Arabia  | NA           | NA           | NA        |
| 10   | UK             | NA           | NA           | NA        |
| 11   | Spain          | 50           | 220          | 0         |
| 12   | France         | NA           | NA           | NA        |
| 13   | Germany        | NA           | NA           | NA        |
| 14   | Czech Republic | 40           | 340          | 1         |
| 15   | Russia CIS     | NA           | NA           | NA        |
| 16   | Argentina      | 10           | 180          | 1         |
| 17   | Greece         | 100          | 180          | 1         |
| 18   | China          | NA           | NA           | NA        |
| 19   | Hong Kong      | NA           | NA           | NA        |
| 20   | Thailand       | 20           | 180          | 1         |
| 21   | Macedonia      | 120          | 150          | 1         |
| 22   | Poland         | 100          | 150          | 0         |
| 23   | Brazil         | NA           | NA           | NA        |

- **Slip Detection** — Enter **y** to enable the slip-rate status of this circuit pack to be used by maintenance software to determine whether an excessive frame slip rate exists. Enter **n** (default) when DMI is used or when testing is not required.



**NOTE:**

Those DS1 facilities that are used to provide the primary and secondary synchronization references should be administered for slip detection **y**. Typically, those other DS1/T1 spans that are used for data applications and which are used as a synchronization service should also be administered for slip detection. This excludes all T1-spans connecting channel banks, unless the channel bank is externally timed. Normally, those DS1/T1 spans that are used exclusively for voice and that are not designed as the primary or secondary synchronization source, should be administered for slip detection **n**.

The digital switch maintains a slip count record for each DS1 interface. The slip count is used to determine if the T1-span is experiencing errors and, if so, the severity of the errors (type alarm). Option **y** enables switching between the primary, secondary, or internal high-accuracy clock.

 **NOTE:**

If as many as 50 percent of those spans that are administered for slip detection are experiencing slips (with respect to the primary), then a decision is made to switch to the secondary.

- **Near-end CSU Type** — Appears only when the DS1 circuit pack is a TN767E or TN464F or later suffix model, `Bit Rate` is **1.544** and `Country Protocol` is **1** (U.S.). Enter **other** or **integrated**.
  - The value **other** indicates that no CSU is attached to the DS1 facility, or that the CSU is an external unit. No options are available for administering the CSU.
  - The value **integrated** indicates that a 120A CSU module is attached to the DS1 board. This integrated CSU (ICSU) can accept software administrable option downlinks and perform the enhanced ICSU functionality if the following conditions are met. The correct suffix of DS1 circuit pack (TN767E or TN464F or later) must be administered via a circuit pack form or must be installed in the PBX. When you enter a value of **integrated**, a second page of the DS1 Circuit Pack form is available to administer CSU module options.

**Alarm When PRI Endpoint Detached** — Displays only when `Connect` is **line-side**. Enter **y** if the UDS1 circuit pack is connected to Roll About Video equipment. (Normally if the video equipment is disconnected, off-board alarms are raised to indicate the loss of connectivity from the system). Valid entries are **y** (default), and **n**.

If you enter **n** in this field, when the UDS1 circuit pack detects a loss of signal, it assumes that the equipment is disconnected and no alarms are raised.

## Page 2 of the form

```
DS1 CIRCUIT PACK

ESF DATA LINK OPTIONS

Network Management Protocol: tabs
Send ANSI-T1.403 One-Second Performance Reports? n
Far-end CSU Address: b

INTEGRATED CSU OPTIONS

Transmit LBO: 0db
Receive ALBO: -26db
Upon DTE LOS: loopback

CPE LOOPBACK JACK OPTIONS

Supply CPE Loopback Jack Power? n
```

### Screen 7-7. DS1 Circuit Pack form (page 2 of 2)

Page 2 of the form appears only when: the version is V3 or greater; the DS1 circuit pack is TN767E, TN464F, or later release; and Framing Mode is **esf** or Near-end CSU Type is **integrated**.

#### ⇒ NOTE:

The following three fields appear only if Framing Mode is **esf**.

- **Network Management Protocol** — Enter **tabs** (default).
- **Send ANSI-T1.403 One-Second Performance Reports** — Appears only when the Network Management Protocol is **tabs**. Enter **y** or **n** (default).
- **Far-end CSU Address** — Appears only when the Network Management Protocol is **tabs**. This field administers the transmit direction address used for the **ESF data link** command. Enter **a** or **b** (default).

#### ⇒ NOTE:

The following four fields appear only if Near-end CSU Type is integrated:

- **Transmit LBO** — (Transmit Line Build-Out) The amount of fixed loss inserted in the transmit direction. Enter **0db** (default), **-7.5db**, **-15db**, or **-22.5db**.
- **Receive ALBO** — (Receive Automatic Line Build-Out) The gain is inserted automatically in the receive direction to compensate for line losses. Enter **26db** (default) or **36db**.

- **Upon DTE LOS** — Identifies how the signal should be handled if the signal is lost (LOS) from the DTE (DS1 circuit pack) towards the network. Enter **loopback** (default) for returning the network signal to the network, or enter **ais** to send an unframed all-ones signal to the network (the AIS or Blue Alarm).
- **Supply CPE Loopback Jack Power** — Enter **y** if the DS1 board should supply power to the CPE Loopback Jack equipment during loopback testing. Otherwise, enter **n** (default).

### Implementation note

The fields that appear on a particular screen vary depending upon the type of circuit pack being administered, the speed, signaling mode, and so on.



## Digit Absorption

---

This form implements up to 5 digit absorption lists. The form may be required for each CO and FX trunk group connected to a step-by-step CO. Each outgoing digit string from the switch to the step-by-step CO is treated per entries in the "Absorption Treatment Assignment" section of the form.

### Administration commands

---

Use the following commands to administer the Digit Absorption form

| Action  | Object           | Qualifier <sup>1</sup>  |
|---------|------------------|-------------------------|
| change  | digit-absorption | 0-4                     |
| display | digit-absorption | 0-4 [print or schedule] |

- 
1. Brackets [ ] indicate the qualifier is optional.

### Form instructions

---

 **NOTE:**

If `Expected Digits` on the Trunk Group form is blank, you cannot administer Digit Absorption.

Pages 1–8 of the form

Page 1 of 1

DIGIT ABSORPTION

List Number:     

ABSORPTION TREATMENT INFORMATION (All selections must be from same group)

|           | Choice | Meaning   |
|-----------|--------|---|
| Group I.  | A      | Digit not absorbed.   |
|           | B      | Digit absorbed repeatedly.  |
|           | C      | Digit absorbed once with no further absorption.   |
| Group II. | A      | Digit not absorbed.   |
|           | D      | Digit absorbed only if it is the first digit.   |
|           | E      | Digit absorbed only if it is the second digit and the first digit was already absorbed. |
|           | F      | Digit asorbed only if it is the first or second digit.                                  |

ABSORPTION TREATMENT ASSIGNMENT (select treatment (A-F) for each digit below)

|      |      |      |      |      |
|------|------|------|------|------|
| 0: A | 2: A | 4: A | 6: A | 8: A |
| 1: A | 3: A | 5: A | 7: A | 9: A |

Screen 7-8. Digit Absorption form (page 1 of 1)

- **List Number** — A display-only field when accessed during administration using a command such as change or display. When completing a paper form, enter a list number **0**, **1**, **2**, **3**, or **4**. The list number is referenced via field entry on the associated trunk group. Up to five different Digit Absorption forms may be administered.
- **ABSORPTION TREATMENT ASSIGNMENT** — Enter a desired treatment letter (**A** through **F**); default is **A**. All choices for the digits 0 through 9 must be taken from the same group (Group I or Group II).

## ISDN Numbering — Private

This form supports Private Numbering Plans (PNP). It allows you to specify the digits to be put in the Calling Number IE, Connected Number Information Element (IE), and the QSIG Party Number for extensions in the Private Numbering Plan.

### Administration commands

Use the following commands to administer the ISDN Numbering - Private form

| Action  | Object | Qualifier         |
|---------|--------|-------------------|
| change  | isdn   | private-numbering |
| display | isdn   | private-numbering |

### Form instructions

Page 1 of 1

ISDN NUMBERING - PRIVATE FORMAT

|                                     |                                      |
|-------------------------------------|--------------------------------------|
| Network Level: <input type="text"/> | PBX Identifier: <input type="text"/> |
| Level 2 code: <input type="text"/>  | Deleted Digits: <input type="text"/> |
| Level 1 code: <input type="text"/>  |                                      |

Screen 7-9. ISDN Number — Private Format form (page 1 of 1)

- Network Level** — Enter the value of the highest regional level employed by the PNP network. Valid entries are **0**, **1**, **2**, or blank (default). Use the following table to find the relationship between the network level and the Numbering Plan Identification/Type of Number (NPI/TON) encoding used in the Calling Number and/or Connected Number IEs in addition to the QSIG Party Number.

| Network Level | NPI | TON              |
|---------------|-----|------------------|
| 0             | PNP | local            |
| 1             | PNP | Regional Level 1 |
| 2             | PNP | Regional Level 2 |

 **NOTE:**

If `Network Level` is left blank and `Send Calling Number` and/or `Send Connected Number` is **y** or **r** with **private** specified for `Numbering Format` on the ISDN Trunk Group form, the `Calling Number` and/or `Connected Number IEs` will not be sent. If the field is left blank but **private** has been specified in `Numbering Format` on the ISDN Trunk Group form, the `Identification Number` (PartyNumber data type) is sent for QSIG PartyNumbers encoded in ASN.1-defined APDUs. In this case, the ASN.1 data type containing the PartyNumber (PresentedAddressScreened, PresentedAddressUnscreened, PresentedNumberScreened, or PresentedNumberUnscreened) is sent marked as “PresentationRestricted” with “NULL” for the associated digits.

- **Level 2 Code** — Enter the switch’s second level regional code in the network. You can enter up to 5 numbers (**0 - 9**), or you can enter a blank (default). You can enter numbers only if `Network Level` is **2**. Administer this field carefully. The system will not check to ensure that you have entered a Level 2 Code that supports the network level you entered in `Network Level`. You will be restricted from administering a non-blank entry if the `Network Level` specified above is less than **2** or blank. However, because blank regional codes are valid, an entry is not required if `Network Level` is **2**.
- **Level 1 Code** — Enter the switch’s first level regional code in the network. You can enter up to 5 numbers (**0 - 9**) or you can enter a blank (default). You can enter a non-blank value only if `Network Level` is **1** or **2**. Administer this field carefully. The system will not check to ensure that you have entered a Level 1 Code that supports the network level you entered in `Network Level`. You will be restricted from administering a non-blank entry if the `Network Level` specified above is less than **1** or blank. However, because blank regional codes are valid, an entry is not required if `Network Level` is **1** or **2**.
- **PBX Identifier** — Similar to a Listed Directory Number in the public network, this field prepended with the regional codes administered above allows the PBX to be uniquely identified in the network. Enter up to 5 numbers (**0 - 9**), or you can enter a blank (default).
- **Deleted Digits** — Enter the number of digits to be deleted from the most significant digits of local extensions prior to sending in the `Calling` and/or `Connected Number IEs` as well as the QSIG PartyNumber. This allows UDP network numbers to be converted to PNP Complete Numbers. Valid entries are **0** (default), **1**, or **2**.

## ISDN Numbering — Public/ Unknown

This form supports the ISDN Call Identification Display feature. The feature provides a name/number display for display-equipped stations within an ISDN network. The system uses the caller's name and number and displays it on the called party's display. Likewise, the called party's name and number can be displayed on the caller's display.

The form allows you to specify the desired digits for the Calling Number IE and the Connected Number IE (in addition to the QSIG Party Number) for any extension in the Public and/or Unknown Number Plans.

Administer these forms if either Send Calling Number, Send Connected Number is specified, or Supplementary Service Protocol is **b** on the trunk group form.

### NOTE:

If the table is not properly administered and Send Calling Number or Send Connected Number is **y** or **r** and Numbering Format on the ISDN Trunk Group form is **public** or **unknown**, the Calling Number and Connected Number IE are not sent. If the table is not administered, but Send Calling Number or Send Connected Number is **public** or **unknown**, the Identification Number (PartyNumber data type) is not sent for QSIG PartyNumbers. In this case, the ASN.1 data type containing the PartyNumber (PresentedAddressScreened, PresentedAddressUnscreened, PresentedNumberScreened, or PresentedNumberUnscreened) will be sent marked as "PresentationRestricted" with "NULL" for the associated digits.

## Administration commands

Use the following commands to administer the ISDN Numbering - Public Unknown form

| Action  | Object | Qualifier                |
|---------|--------|--------------------------|
| change  | isdn   | public-unknown-numbering |
| display | isdn   | public-unknown-numbering |

**Form instructions**

---

**Pages 1 of the form**

| ISDN NUMBERING - PUBLIC/UNKNOWN FORMAT |          |            |                  |         |          |            |                  |
|--|----------|------------|------------------|---------|----------|------------|------------------|
| Ext Len                                | Ext Code | CPN Prefix | Total CPN Length | Ext Len | Ext Code | CPN Prefix | Total CPN Length |
| -                                      | _____    | _____      | —                | -       | _____    | _____      | —                |
| -                                      | _____    | _____      | —                | -       | _____    | _____      | —                |
| -                                      | _____    | _____      | —                | -       | _____    | _____      | —                |
| -                                      | _____    | _____      | —                | -       | _____    | _____      | —                |
| -                                      | _____    | _____      | —                | -       | _____    | _____      | —                |
| -                                      | _____    | _____      | —                | -       | _____    | _____      | —                |
| -                                      | _____    | _____      | —                | -       | _____    | _____      | —                |
| -                                      | _____    | _____      | —                | -       | _____    | _____      | —                |
| -                                      | _____    | _____      | —                | -       | _____    | _____      | —                |
| -                                      | _____    | _____      | —                | -       | _____    | _____      | —                |
| -                                      | _____    | _____      | —                | -       | _____    | _____      | —                |
| -                                      | _____    | _____      | —                | -       | _____    | _____      | —                |
| -                                      | _____    | _____      | —                | -       | _____    | _____      | —                |
| -                                      | _____    | _____      | —                | -       | _____    | _____      | —                |
| -                                      | _____    | _____      | —                | -       | _____    | _____      | —                |
| -                                      | _____    | _____      | —                | -       | _____    | _____      | —                |
| -                                      | _____    | _____      | —                | -       | _____    | _____      | —                |
| -                                      | _____    | _____      | —                | -       | _____    | _____      | —                |
| -                                      | _____    | _____      | —                | -       | _____    | _____      | —                |
| -                                      | _____    | _____      | —                | -       | _____    | _____      | —                |
| -                                      | _____    | _____      | —                | -       | _____    | _____      | —                |
| -                                      | _____    | _____      | —                | -       | _____    | _____      | —                |

Screen 7-10. ISDN Numbering Public/Unknown form (page 1 of 8)

- **Ext Len** — Specifies the number of digits the extension can have. Enter a number from **0–5** that corresponds to the extension lengths allowed by the dial plan, or leave blank.
- **Ext Code** — Allows for groups of extensions to be administered. The Ext Code can be up to 5-digits long depending on the Ext Len field entry. The entry cannot be greater than the Ext Len field entry. For example, in the case of a 4-digit Ext Len field entry, an Ext Code of 12 is the equivalent of all extensions of the form 12xx, excluding any explicitly listed longer codes. If a code of 123 is also listed, the 12 code is equivalent of all extensions of the form 12xx except extensions of the form 123x. The coding precludes having to list all the applicable 12xx extensions. Valid entries are digits **0–9**, **attd** for attendant, or blank.

 **NOTE:**  
 When "0" alone is entered, the Ext Len field must be 1 and the DDD number must be 10-digits.

- **CPN Prefix** — Specifies the number that is added to the beginning of the extension to form a 10-digit CPN number. The CPN Prefix can be a 6- to 10-digit number, or can be blank. If it is a 10-digit number, the extension number is not used to formulate the 10-digit CPN number. Only digits are allowed in the CPN Prefix column. Leading spaces, or spaces in between the digits, are not allowed.

If the number of digits in the CPN Prefix plus the extension length exceeds 10, excess leading digits of the extension are deleted when formulating the 10-digit CPN number. If the number of CPN Prefix digits plus the extension length is less than 10, the entry is disallowed except for a blank entry. If the CPN Prefix entry is left blank, no calling party number information is provided to the called party and no connected party number information is provided to the calling party.

- **Total CPN Length** — Enter the total number of digits to send. Valid entries are **0–15**, or blank.

## ISDN TSC Gateway Channel Assignments

---

This form is required when the switch is to act as a gateway between a switch that supports the Temporary Signaling Connections (TSC) feature and a non-TSC-compatible switch. The gateway provides interface protocols necessary for communications to exist between a switch administered with Non-Call Associated TSCs in a Signaling Group on the ISDN side and a processor channel (BX.25) on the non-ISDN side. A NCA-TSC is a type of virtual connection established for exchanging user information messages on ISDN-PRI D-channels. There is no B-channel related to the connection.

### Administration commands

---

Use the following commands to administer the ISDN TSC Gateway Channel Assignments form

| Action  | Object           | Qualifier <sup>1</sup> |
|---------|------------------|------------------------|
| change  | isdn tsc-gateway |                        |
| display | isdn tsc-gateway | ['print']              |

- 
1. Brackets [ ] indicate the qualifier is optional. Single quotes ( ' ') indicate the text inside the quote must be entered exactly as shown or an abbreviated form of the word may be entered.



**Form instructions**

---

Page 1 of 2

| ISDN TSC GATEWAY CHANNEL ASSIGNMENT |                 |     |                   |               |           |                 |     |                   |               |
|-------------------------------------|-----------------|-----|-------------------|---------------|-----------|-----------------|-----|-------------------|---------------|
| Sig Group                           | Adm'd TSC Index | NCA | Processor Channel | Appli- cation | Sig Group | Adm'd TSC Index | NCA | Processor Channel | Appli- cation |
| 1: -                                | ---             |     | ---               | -----         | 17: -     | ---             |     | ---               | -----         |
| 2: -                                | ---             |     | ---               | -----         | 18: -     | ---             |     | ---               | -----         |
| 3: -                                | ---             |     | ---               | -----         | 19: -     | ---             |     | ---               | -----         |
| 4: -                                | ---             |     | ---               | -----         | 20: -     | ---             |     | ---               | -----         |
| 5: -                                | ---             |     | ---               | -----         | 21: -     | ---             |     | ---               | -----         |
| 6: -                                | ---             |     | ---               | -----         | 22: -     | ---             |     | ---               | -----         |
| 7: -                                | ---             |     | ---               | -----         | 23: -     | ---             |     | ---               | -----         |
| 8: -                                | ---             |     | ---               | -----         | 24: -     | ---             |     | ---               | -----         |
| 9: -                                | ---             |     | ---               | -----         | 25: -     | ---             |     | ---               | -----         |
| 10: -                               | ---             |     | ---               | -----         | 26: -     | ---             |     | ---               | -----         |
| 11: -                               | ---             |     | ---               | -----         | 27: -     | ---             |     | ---               | -----         |
| 12: -                               | ---             |     | ---               | -----         | 28: -     | ---             |     | ---               | -----         |
| 13: -                               | ---             |     | ---               | -----         | 29: -     | ---             |     | ---               | -----         |
| 14: -                               | ---             |     | ---               | -----         | 30: -     | ---             |     | ---               | -----         |
| 15: -                               | ---             |     | ---               | -----         | 31: -     | ---             |     | ---               | -----         |
| 16: -                               | ---             |     | ---               | -----         | 32: -     | ---             |     | ---               | -----         |

Screen 7-11. ISDN TSC Gateway Channel Assignment form

- **Sig Group** — Used to indicate the Signaling Group to which the NCA-TSC belongs. Default is blank.
- **Adm'd NCA TSC Index** — Used to indicate the administered NCA-TSC that acts as one endpoint of the gateway. Default is blank.
- **Processor Channel** — Used to indicate the processor channel to which the administered NCA-TSC index will be mapped. This processor channel is used as another endpoint of the connection in this gateway assignment. The default is blank.
- **Application** — Used to indicate the feature this gateway is used for. Gateway channels can be used for DCS+ or ISDN-PRI DCS AUDIX feature. Valid entries are **audix** or **dcs**; default is blank.



The Network-Facilities form displays the AT&T Switched Network Services in Predefined Services/Features. See [“ISDN-BRI trunk group” on page 7-198](#) or [“ISDN-PRI trunk group” on page 7-219](#) for a list of predefined Services Types.

- **Name** — Contains up to 15 alphanumeric characters to specify the name of the indicated Service/Feature.
- **Facility Type** — A **0** indicates that the associated entry is a feature, and a **1** indicates the associated entry is a service. A **2** indicates that the associated entry is of type incoming. A **3** indicates that the associated entry is of type outgoing.



**NOTE:**

Types 2 and 3 can be administered if `Usage Allocation Enhancements` on the `System-Parameters Customer-Options` form is enabled.

- **Facility Coding** — Contains five binary values that specify the ISDN encoding value of the associated Service/Feature.



**NOTE:**

This field does not display if `Facility Type` is either **2** or **3**.

The additional Services/Features area on the form is available for new services and features. The number of entries available depends on system memory and configuration.

## PRI Endpoint

---

This form administers PRI Endpoints for the Wideband Switching feature.

### NOTE:

A PRI Endpoint with a width greater than 1 may be administered only if the Wideband Switching feature has been enabled on the System-Parameters Customer-Options form.

A PRI Endpoint is an endpoint application connected to line-side ISDN-PRI facilities and has standard ISDN-PRI signaling interfaces to the system. For information on endpoint applications connected to line-side non-ISDN T1 or E1 facilities, see [“Access Endpoint” on page 7-72](#) in this module.

A PRI Endpoint is defined as 1–31 adjacent DS0s/B-channels, addressable via a single extension, and signaled via a D-channel (Signaling Group) over a standard T1 or E1 ISDN-PRI interface.

### Administration commands

---

Use the following commands to administer the PRI Endpoint form.

| Action  | Object       | Qualifier <sup>1</sup>                       |
|---------|--------------|--|
| add     | pri-endpoint | extension or 'next'                          |
| change  | pri-endpoint | extension                                    |
| display | pri-endpoint | extension ['print' or 'schedule']            |
| list    | pri-endpoint | extension ['count' X]['print' or 'schedule'] |
| remove  | pri-endpoint | extension                                    |

- 
1. Brackets [ ] indicate the qualifier is optional. Single quotes ( ' ) indicate the text inside the quote must be entered exactly as shown or an abbreviated form of the word may be entered.

## Form instructions

```

add pri-endpoint next                                     Page 1 of 1
                                                    PRI ENDPOINT

      Extension: 300
      Name: 27 character PRI Endpoint 1
      (Starting) Port:                               Width: 1
      Originating Auto Restoration? n                Signaling Group:
      COR: 1                                         COS: 1
      TN: 1                                         Simultaneous Calls? n
      Maintenance Tests? y

                                                    WIDEBAND SUPPORT OPTIONS

      H0? n
      H11? n
      H12? n
      NXDS0? y   Contiguous? n
    
```

### Screen 7-13. PRI Endpoint form

- **Extension** — Display-only field when the form is accessed using an administration command such as **change** or **display**. This is the extension number used to access the PRI endpoint. Enter a valid unassigned extension number when completing a paper form. Default is blank.
- **Name** — Enter up to 27 alphanumeric characters to identify the endpoint. Default is blank.
- **(Starting) Port** — Enter the seven-character starting port of the PRI Endpoint.

The entry breaks down as follows:

| Characters | Meaning        | Value   |
|------------|----------------|---|
| 1-2        | Cabinet Number | 01 through 22 (R5r and later configurations)  |
|            |                | 01 through 03 (R5si and later configurations) |
|            |                | 01 through 02 (G3s)                           |
| 3          | Carrier        | A through E                                   |
| 4-5        | Slot Number    | 01 through 20                                 |
| 6-7        | Circuit Number | 01 through 31 (DS1 Interface ports)           |

- **Width** — Enter the number of adjacent DS0 ports (**1** to **31**), beginning with the specified Starting Port, that make up the PRI Endpoint. A width of **6** defines a PRI Endpoint that can support data rates up to 384 Kbps. This field cannot be blank.

- **Originating Auto Restoration** — Enter **y** to automatically restore calls originating from this PRI Endpoint (while maintaining endpoint call status) in the case of network failure if the call is over SDDN network facilities. Default is **n**.
- **Signaling Group** — Enter the D-channel or D-channel pair that will provide the signaling information for the set of B-channels that make up the PRI Endpoint.  
  
Valid entries are: **1** to **166** (R5r and later configurations), **1** to **8** (R5si and later configurations), and **1** to **4** (G3s). Default is blank.
- **COR** — Enter the appropriate class of restriction (COR) number from **0–95**, to determine calling and called party privileges. Default is **1**.
- **COS** — Enter the appropriate COS number from **0–15**. The COS is administered (see COS form instructions) to determine a certain class of features that can be activated by, or on behalf of, the endpoint. Default is **1**.
- **Maintenance Tests** — Enter **y** (default) to run hourly maintenance tests on this PRI Endpoint. Entering **n** disables the hourly maintenance tests for this PRI Endpoint.
- **Simultaneous Calls** — Enter **y** to specify that multiple simultaneous calls can be placed to/from the PRI Endpoint. Default is **n**.
- **H0** — Enter **y** to specify the ISDN information transfer rate for 384 Kbps of data, which is comprised of six B-channels. When a PRI Endpoint is administered to support H0, the hunt algorithm to satisfy a call requiring 384 Kbps of bandwidth uses a fixed allocation scheme. Default is **n**.
- **H11** — Enter **y** to specify the ISDN information transfer rate for 1536 Kbps of data, which is comprised of 24 B-channels. When a PRI Endpoint is administered to support H11, the hunt algorithm to satisfy a call requiring 1536 Kbps of bandwidth uses a fixed allocation scheme. Default is **n**.
- **H12** — Enter **y** to specify the ISDN information transfer rate for 1920 Kbps data, which includes 30 B-channels. When a PE is administered to support H12, the hunt algorithm to satisfy a call requiring 1920 Kbps of bandwidth uses a fixed allocation scheme. Default is **n**.
- **NXDS0** — Enter **y** to specify the NXDS0 multi-rate service. Default is **n**.

- **Contiguous?** — Specifies whether to hunt contiguous NXDS0 channels. This field only appears if **y** is entered in NXDS0.

The hunt algorithm to satisfy an NXDS0 call is as follows:

- Enter **y** to specify the "floating" scheme. NXDS0 calls are placed on a contiguous group of B-channels large enough to satisfy the requested bandwidth without constraint on the starting channel (no fixed starting point trunk).

 **NOTE:**

H0 and NXDS0 "floating" scheme cannot both be **y**.

- Enter **n** to specify the "flexible" scheme. NXDS0 calls are placed on any set of B-channels on the same facility as long as the requested bandwidth is satisfied. There are no constraints, such as contiguity of B-channels or fixed starting points.

## Signaling Group

---

This form identifies groups of ISDN-PRI DS1 interface B-channels for which a given D-channel or D-channel pair carries associated signaling information. The Non-Facility Associated Signaling (NFAS) feature allows a D-channel to convey signaling information for B-channels that are located on DS1 facilities other than the one containing the D-channel. With NFAS, a signaling group does not necessarily correspond to a single DS1 interface. The Signaling Group form is administered to show how B-channels and D-channels are related.

The Signaling Group form also supports Facility Associated Signaling (FAS). The form establishes the fact that a D-channel carries signaling information for all B-channels on its associated DS1 interface, and for no others.

In addition, the form administers Temporary Signaling Connections (TSC) used in support of DCS Over ISDN-PRI D-channel (includes ISDN-PRI D-channel DCS AUDIX).

### Administration commands

---

Use the following commands to administer the Signaling Group form

| Action  | Object          | Qualifier <sup>1</sup>        |
|---------|-----------------|-------------------------------|
| add     | signaling-group | 1-MAX or 'next'               |
| change  | signaling-group | 1-MAX                         |
| display | signaling-group | 1-MAX ['print' or 'schedule'] |
| list    | signaling-group | 1-MAX ['print' or 'schedule'] |
| remove  | signaling-group | 1-MAX                         |

- 
1. Brackets [ ] indicate the qualifier is optional. Single quotes ( ' ' ) indicate the text inside the quote must be entered exactly as shown or an abbreviated form of the word may be entered. MAX is the maximum number available in your system configuration.





The port number assigns the primary D-channel in the Signaling Group. For 24-channel facilities, the 24th port is assigned as the D-channel. For 32-channel facilities, the 16th port is assigned as the D-channel. Default is blank.

- **Secondary D-channel** — Displays when Associated Signaling is **n** (indicates NFAS). Enter a 6- to 7-character port number associated with the DS1 Interface circuit pack port used for secondary D-channel signaling:

The entry breaks down as follows:

| Characters | Meaning        | Value   |
|------------|----------------|---|
| 1-2        | Cabinet Number | 01 through 44 (R5r and later configurations)  |
|            |                | 01 through 03 (R5si and later configurations) |
|            |                | 01 (R5vs and later configurations)            |
| 3          | Carrier        | A through E                                   |
| 4-5        | Slot Number    | 01 through 20                                 |
| 6-7        | Port           | 16 or 24                                      |

The port number assigns the secondary D-channel in the Signaling Group. For 24-channel facilities, the 24th port is assigned as the D-channel. For 32-channel facilities, the 16th port is assigned as the D-channel. Default is blank.

- **Max Number of NCA TSC** — The maximum number of simultaneous Non-Call Associated Temporary Signaling Connections (NCA-TSCs) that can exist in the Signaling Group. This number includes all NCA-TSCs that are administered on this form and those NCA-TSCs that tandem through the switch in-route to another switch in the network. Default is **0**.
- **Max number of CA TSC** — The maximum number of simultaneous Call Associated Temporary Signaling Connections (CA-TSCs) that can exist in the Signaling Group. Typically, the number of ISDN-PRI trunk group members controlled by the Signaling Group. Default is **0**.
- **Trunk Group For NCA TSC** — The ISDN-PRI trunk group number whose incoming call handling table will be used to handle incoming NCA-TSCs through the Signaling Group. Enter the assigned ISDN-PRI trunk group number whose call handling table will be used to route the incoming NCA TSCs. (An ISDN-BRI trunk group may not be used.) Default is blank.
- **Trunk Group for Channel Selection** — Enter the assigned trunk group number. (An ISDN-BRI trunk group may not be used.) Default is blank.
- **Supplementary Service Protocol** — Determines whether AT&T NCA TSCs or QSIG NCA TSCs are sent over the interface. Valid entries are **a** (AT&T protocol) or **b** (QSIG protocol). Blank is not a valid entry. Default is

a. This field may be set to **b** only if `Basic Supplementary Services` on the `System-Parameters Customer-Options` form is **y**. If this field is **b**, pages 2 through 5 do not appear.

To change this field from **a** to **b**, first check the `Adm'd NCA TSC Index` field on the ["ISDN TSC Gateway Channel Assignments" on page 7-98](#). Make sure no NCA TSC on the `Signaling Group` form is administered as a Gateway Channel. If they are, you must remove the NCA TSC Gateway assignment first before this field can be changed to **b**.

- **Trunk Brd** — Displays when `Associated Signaling` is "n" (indicates NFAS). Default is blank. Enter a 5-character DS1 Interface circuit pack number that has trunk members belonging to this Signaling Group.

The entry breaks down as follows:

| Characters | Meaning        | Value   |
|------------|----------------|---|
| 1-2        | Cabinet Number | 01 through 44 (R5r and later configurations)  |
|            |                | 01 through 03 (R5si and later configurations) |
|            |                | 01 (R5vs and later configurations)            |
| 3          | Carrier        | A through E                                   |
| 4-5        | Slot Number    | 01 through 20                                 |

- **Interface ID** — Displays when `Associated Signaling` is "n" (indicates NFAS). Enter an interface ID for the corresponding DS1 Interface circuit pack. In an NFAS Signaling Group, an Interface ID must be assigned to each DS1 facility so that it can be referenced by both interfacing switches. When a call is established between switches, the Interface ID at each end is used to determine which B-channel is to be used to establish the call. The Interface ID numbers on both ends must be the same.

Pages 2 through 5 of the form

| Service/Feature: _____ |            | ADMINISTERED NCA TSC ASSIGNMENT |             |              |  | Page 2 of 5 |          |
|------------------------|------------|---------------------------------|-------------|--------------|--|-------------|----------|
| TSC Index              | Local Ext. | Enabled                         | Established | Dest. Digits | As-needed Inactivity Time-out (min): _____ | Adj. Name   | Mach. ID |
| 1:                     | _____      | -                               | _____       | _____        | _____                                      | _____       | _____    |
| 2:                     | _____      | -                               | _____       | _____        | _____                                      | _____       | _____    |
| 3:                     | _____      | -                               | _____       | _____        | _____                                      | _____       | _____    |
| 4:                     | _____      | -                               | _____       | _____        | _____                                      | _____       | _____    |
| 5:                     | _____      | -                               | _____       | _____        | _____                                      | _____       | _____    |
| 6:                     | _____      | -                               | _____       | _____        | _____                                      | _____       | _____    |
| 7:                     | _____      | -                               | _____       | _____        | _____                                      | _____       | _____    |
| 8:                     | _____      | -                               | _____       | _____        | _____                                      | _____       | _____    |
| 9:                     | _____      | -                               | _____       | _____        | _____                                      | _____       | _____    |
| 10:                    | _____      | -                               | _____       | _____        | _____                                      | _____       | _____    |
| 11:                    | _____      | -                               | _____       | _____        | _____                                      | _____       | _____    |
| 12:                    | _____      | -                               | _____       | _____        | _____                                      | _____       | _____    |
| 13:                    | _____      | -                               | _____       | _____        | _____                                      | _____       | _____    |
| 14:                    | _____      | -                               | _____       | _____        | _____                                      | _____       | _____    |
| 15:                    | _____      | -                               | _____       | _____        | _____                                      | _____       | _____    |
| 16:                    | _____      | -                               | _____       | _____        | _____                                      | _____       | _____    |

Screen 7-15. Signaling Group form Administered NCA TSC Assignment (page 2 of 5)

- **Service/Feature** — The service type for all administered NCA-TSCs assigned in this Signaling Group. Valid entries are: **accunet**, **i800**, **inwats**, **lds**, **mega800**, **megacom**, **multiquest**, **nca-tsc**, **operator**, **sdn**, **sub-operator**, **wats-max-bnd**, and Facility Type 0 and 1 user-defined services. Default is blank.
- **As-needed Inactivity Time-out (min)** — The inactivity time-out for as-needed NCA-TSCs assigned in the Signaling Group. An as-needed administered NCA-TSC staying inactive in this time period will be removed from service. Default is blank.
- **TSC Index** — Display-only field. Specifies the administered NCA-TSCs assigned. The administered NCA TSC index represents one DCS or DCS AUDIX logical channel connecting any two switches. The Index number ranges from 1–64.
- **Local Ext** — Used to assign an extension on the switch to the administered NCA-TSC. Enter an unassigned extension number.



**NOTE:**

The extension cannot be previously assigned to another administered NCA-TSC, station, or data module, and so on.

- **Enabled** — Enter "y" to enable the administered NCA-TSC.
- **Establish** — Used to indicate the strategy for establishing this administered NCA-TSC. Valid entries are **permanent** and **as-needed**. An entry of **permanent** means that the administered NCA-TSC can be established by either the near end or the far end. An entry of **as-needed**

means the administered NCA-TSC will be established the first time the administered NCA-TSC is needed. It can be set up either by the near end or far end switch. Default is blank.

- **Dest. Digits** — Used to route the administered NCA-TSC to the far end switch. Valid entries are digits **0** through **9** and the **+**, **\***, and **#** special characters, and can include up to 15 digits. Default is blank.



**NOTE:**

These digits are sent as entered to the destination switch; no routing or other digit manipulation is performed.

- **Appl.** — Specifies the application this administered NCA-TSC is going to be used for. Valid entries are **audix**, **dcs**, and **gateway**. The **audix** entry is used for ISDN-PRI D-channel DCS AUDIX feature. The **dcs** entry is used for the DCS Over ISDN-PRI D-channel feature. The "gateway" entry is used when the administered NCA-TSC will be used as one end in the gateway channel connecting to a BX.25 link. If **gateway** is entered, then the ISDN TSC Gateway Channel Assignments form must be completed. Default is blank.
- **Adjunct Name** — Only displays for R6r and later configurations. Displays when `App1` is **audix**. Enter the name of the AUDIX as it appears on the "Adjunct Names" form.
- **Machine ID** — Used to indicate the far-end PBX or the AUDIX machine to which this administered NCA-TSC will be connected. Default is blank.

## Synchronization Plan

---

This form assigns primary and secondary external synchronization sources. This provides synchronization between the switch and digital facilities that the switch is connected to. When the switch is connected to digital facilities, the switch (both Processor Cabinets and Expansion Cabinets) must be synchronized to the incoming data rate of 8,000 frames-per-second. This timing information reference may be derived from DS1 facilities or from a Stratum 3 external clock. Loss of the reference signal, excessive phase changes, and variation in timing frequency can cause loss of data or dropped data connections. When no external digital facilities, including Stratum 3 external clocks, are present or when a switch is the "master" node of a network providing timing to the rest of the network, the timing can come from an oscillator on the switch's tone/clock circuit pack.

 **NOTE:**

The Synchronization Plan may not be required for some digital connections. The switch's internal clock may suffice.

### Administration commands

---

Use the following commands to administer the Synchronization Plan form.

| Action  | Object          | Qualifier <sup>1</sup>  |
|---------|-----------------|-------------------------|
| change  | synchronization | —                       |
| display | synchronization | ['print' or 'schedule'] |

- 
1. Brackets [ ] indicate the qualifier is optional. Single quotes ( ' ' ) indicate the text inside the quote must be entered exactly as shown or an abbreviated form of the word may be entered.

**Form instructions**

**Page 1 of the form**

Page 1 of X

SYNCHRONIZATION PLAN

SYNCHRONIZATION SOURCE (circuit pack location)

Stratum:   

Port Network:   

Primary:                           Secondary:     

| Location                    | Name                        | Slip      | Type                        | Location                    | Name                        | Slip      | Type      |
|-----------------------------|-----------------------------|-----------|-----------------------------|-----------------------------|-----------------------------|-----------|-----------|
| 01C17                       | <u>                    </u> | D         | UDS1-BD                     | <u>                    </u> | <u>                    </u> | <u>  </u> | <u>  </u> |
| 01C18                       | <u>                    </u> | Y         | TBRI-BD                     | <u>                    </u> | <u>                    </u> | <u>  </u> | <u>  </u> |
| <u>                    </u> | <u>                    </u> | <u>  </u> | <u>                    </u> | <u>                    </u> | <u>                    </u> | <u>  </u> | <u>  </u> |
| <u>                    </u> | <u>                    </u> | <u>  </u> | <u>                    </u> | <u>                    </u> | <u>                    </u> | <u>  </u> | <u>  </u> |
| <u>                    </u> | <u>                    </u> | <u>  </u> | <u>                    </u> | <u>                    </u> | <u>                    </u> | <u>  </u> | <u>  </u> |
| <u>                    </u> | <u>                    </u> | <u>  </u> | <u>                    </u> | <u>                    </u> | <u>                    </u> | <u>  </u> | <u>  </u> |
| <u>                    </u> | <u>                    </u> | <u>  </u> | <u>                    </u> | <u>                    </u> | <u>                    </u> | <u>  </u> | <u>  </u> |

NOTE: TN722B & TN464B DS1 sources result in stratum 4, type II synchronization

**Screen 7-16. Synchronization Plan form (page 1 of X)**

- **Stratum** — Enter the stratum level to be used for synchronization. Valid entries are **3** or **4** (default).



**NOTE:**

Stratum 3 capability is only possible when using a TN780 Tone Clock circuit pack.

- **Port Network** — Only displays when **Stratum** is **3**. This is a display-only field.
- **Primary** — Only displays when **Stratum** is **4**. Note that the Primary and Secondary synchronization sources (DS1 or BRI trunk facilities) must be on the same Port Cabinet (that is, PPN, EPN1, or EPN3). Enter a 4- or 5-character circuit pack location number for the circuit pack that will function as the primary synchronization source.

The entry breaks down as follows:

| Characters | Meaning        | Value   |
|------------|----------------|---|
| 1-2        | Cabinet Number | 01 through 44 (R5r and later configurations)<br>01 through 03 (R5si and later configurations)<br>01 (R5vs and later configurations) |
| 3          | Carrier        | A through E   |
| 4-5        | Slot Number    | 01 through 20   |

A blank entry means no external source. The clock circuit pack's internal source is the implicit last choice. Only one switch in the network can function as the primary synchronization source.

- **Secondary** — Only displays when *Stratum* is 4. Note that the Primary and Secondary synchronization sources (DS1 or BRI trunk facilities) must be on the same Port Cabinet (that is, PPN, EPN1, or EPN3). Enter a 4- or 5-character circuit pack location number for the circuit pack that will function as a secondary synchronization source.

The entry breaks down as follows:

| Characters | Meaning        | Value   |
|------------|----------------|---|
| 1-2        | Cabinet Number | 01 through 44 (R5r and later configurations)<br>01 through 03 (R5si and later configurations)<br>01 (R5vs and later configurations) |
| 3          | Carrier        | A through E   |
| 4-5        | Slot Number    | 01 through 20   |

The system will select automatically the secondary circuit pack if the primary circuit has a failure.

### Pages 1–X of the form

- **Location/Name** — Only displays if *Stratum* is 4. Identifies the location and name for each DS1 or BRI trunk circuit pack administered via the DS1 or BRI Trunk Circuit Pack form. These fields are display only.
- **Slip** — Displays as **y** if *Slip Detection* has been enabled for any of the 8 ports on the DS1 Circuit Pack form.
- **Type** — Contains a value for each displayed circuit pack that indicates the circuit pack's maintenance name. For example, UDS1-BD appears for a TN464 circuit pack, and TBR1-BD appears for a TN2185 circuit pack.

Instructions for administering a DS1/DMI interface are provided in *AT&T Generic 1 and System 75 and System 85 DS1/DMI/ISDN-PRI Interface Service Manual*, 555-025-101.

### Implementation notes

---

This is a 6-page form for R6r and later configurations and a 2-page form for R6si and later configurations.



## Trunk Groups — General

---

This section contains the forms and instructions required to administer trunk groups in DEFINITY ECS. See the *DEFINITY ECS System Description Pocket Reference* for capacity information on the maximum number of trunks and trunk groups for each system configuration.

### What are trunks?

---

Communication links called trunks connect two switching systems. These trunks are grouped together through trunk group administration when trunks of the same type are used for the same application.

Trunk group administration allows the system administrator to assign service characteristics to a group of trunks rather than to each trunk individually. Changes can be made and characteristics can be removed on a group basis.

Trunks and access endpoints consume the same resource. Therefore, the sum of trunks and access endpoints cannot exceed the total number of trunks allowed for a particular DEFINITY ECS configuration.

### Trunk group types

---

This section addresses forms for the following trunk group types:

- Access trunk group
- Advanced Private Line Termination (APLT) trunk group
- Centralized Automatic Message Accounting (CAMA) trunk group
- Central Office (CO) trunk group
- Customer Provided Equipment (CPE) trunk group
- Digital Multiplex Interface Bit-Oriented Signaling (DMI-BOS) trunk group
- Direct Inward Dialing (DID) trunk group
- Direct Inward/Outward Dialing (DIOD) trunk group
- Foreign Exchange (FX) trunk group
- Integrated Services Digital Network-Basic Rate Interface (ISDN-BRI) trunk group. (The ISDN-BRI has the same group type as the ISDN-PRI. The difference is in the trunk member ports. The ISDN-BRI ports belong to the ISDN-BRI circuit packs (TN2185). The ISDN-PRI ports belong to the DS1 circuit packs (TN464).)
- Integrated Services Digital Network-Primary Rate Interface (ISDN-PRI) trunk group
- Personal Central Office Line (PCOL) trunk group
- Release Link Trunk (RLT) group

- Tandem trunk group
- Tie trunk group
- Wide Area Telecommunications Service (WATS) trunk group

## **Introduction to trunk groups**

---

This section contains three types of material.

- An overview of various trunk-related terms and concepts
- Descriptions of fields displayed on many of the various trunk group forms, organized alphabetically, by the form on which they appear
- Trunk group forms and fields unique to a particular trunk group

For specific technical information about trunk groups, see the *DEFINITY Communications System Generic 1 and System 75 and System 85 DS1/DMII/ISDN-PRI Reference*.

## **Trunk characteristics**

---

A trunk is named for its transmission characteristics and can be analog or digital depending on the type of signals it carries. One transmission characteristic is signaling, which is the transmission of supervision, address, alerting, or other switching information.

A trunk is further classified as one of the following:

- One-way incoming trunk — A local trunk that can be selected (seized) by the far-end connected switch.
- One-way outgoing trunk — A trunk that can be seized by the local switch to call the far-end switch.
- Two-way trunk — A trunk that can be seized at either end of the connected switches.

## **Supervisory signaling**

---

Supervisory signaling establishes or sets up the connection of the local switch to the distant switch. In general, supervisory signaling can be thought of in two phases:

- Seizure signal — The originating office's signal for a request for service from the distant office.
- Start dial signal — The distant office's acknowledgment that it is ready to accept dialing from the originating office.

## Types of supervisory signaling

The following types of supervision signaling are used in trunks.

- **Ear & Mouth (E&M) supervision** — A symmetric signaling scheme used on private network trunks in which dc voltage levels are sent over E&M leads. The E&M leads are separate from the transmission path. E & M signals indicate on-hook/off-hook states of each end of the connection path.
- **Ground Start (GS) supervision** — A supervisory signaling scheme used on public network trunks in which ground is applied on the tip (T) lead by the CO and on the ring (R) lead by the switch. For example, the calling switch on a call to a CO using an outgoing trunk interface seizes the outgoing trunk by placing a ground on the trunk interface R lead. The CO recognizes the trunk seizure as a request for service and grounds the trunk T lead to indicate to the calling switch that the CO is ready to receive digits. Ground Start trunks are preferred over trunks using Loop Start signaling (description follows) for the following reasons:
  - The tip ground seizure that the distant switch sends minimizes the interval during which a two-way trunk can be seized from both ends (called glare) since the switch can make trunks busy to outgoing calls almost immediately.
  - Ground Start trunks provide a positive indication of a distant switch's disconnect. The removal of the tip ground can be acted on:
    - To prevent a station line from being connected to CO dial tone by remaining off-hook after completing a call. This prevents a restricted station from making an unauthorized call after placing an authorized call via the attendant.
    - To hold the trunk busy until the CO disconnects so that another switch cannot seize the trunk and be connected to the CO party of the previous call.
- **Loop Start (LS) supervision** — A supervisory signaling scheme used between a telephone and a switch in which the telephone or far-end office completes the loop current path formed by the trunk leads (wires). The circuit provides one signaling state when it is open and another when it is closed. A third signaling state is achieved by changing the direction or magnitude of current in the loop. The most preferred method of loop start signaling is reverse battery signaling. Disconnect times when using loop start signaling can result in delays of up to 10–20 seconds. In addition, glare, as described in ground start, is possible.
- **Reverse Battery (RB) supervision** — A supervisory technique on one-way trunks that uses open and closure signals from the originating end and reversals of battery and ground from the terminating end (normally used on direct inward dialing trunks).

## Transmission of address

With signaling there are three types of transmission of address. Transmission of address is the method of signaling used to represent digits and/or characters for called numbers, calling numbers, and so on. The methods of addressing are dial pulse (DP), dual tone multifrequency (DTMF), and multifrequency (MF) addressing.

- **DP addressing** — A means of signaling that consists of regular momentary interruptions of a direct or alternating current at the sending end. The number of interruptions corresponds to the value of a digit or character (alternating current is not used by switches). The interruptions usually are produced by a rotary telephone dial, or may be produced by a sender in a switching system.
- **DTMF addressing** — Signaling arrangements (commonly known as touch-tone) that consist of two, simultaneous, dialing signals. One tone is from a low group of four frequencies. The other tone is from a high group of four frequencies. Both tones correspond to digits, letters, or characters (0–9, A–Y, or \* and #). One of the tones (1,633 Hz) from the high group is a spare.
- **MF addressing** — Signaling arrangements that make use of only 2 frequencies out of 6 to represent 10 decimal digits (0–9) and 5 auxiliary signals. MF signals are used for called number addressing, calling number identification. They also report whether the far end is ringing or busy.

## Transmission of alerting

Network trunks operate as automatic, immediate start, dial tone, wink start, or delay dial according to the type of start dial signal (alerting) the switch sends out or expects to receive. The different transmissions of alerting are as follows:

- **Automatic** — The originating switch sends no digits or start dial signal and expects the terminating switch to complete the call. The call usually is completed by the attendant or other service such as Centralized Attendant Service (CAS).
- **Immediate start** — The originating switch sends digits immediately without waiting for a start dial signal from the terminating switch.
- **Dial tone** — The terminating switch sends precise dial tone to the originating switch. This indicates the terminating switch is ready to receive digits.
- **Wink start** — The terminating switch sends a wink start (momentary off-hook) signal to the originating switch. This indicates the terminating switch is ready to receive digits.
- **Delay dial** — The terminating switch sends a delay dial signal (an off-hook signal followed by an on-hook signal) to the originating switch. This indicates the terminating switch is ready to receive digits.

With digital trunks, signaling schemes are basically the same as for analog trunks when establishing a call. Supervisory, addressing, and alerting have been carried over to the digital trunks. These schemes are handled in a variety of ways to indicate particular calling states, such as on-hook, off-hook, ringing, not ringing, and so on, by using A and B bit-timed signaling. A and B bits carry a 0 or 1 depending on the type of trunk, the near-end channel unit type, far-end channel type, trunk condition (open loop, loop closure, reverse battery, and so on), and whether it is transmit or receive signaling. In addition to the above, see [“DS1 Circuit Pack form” on page 7-79](#) for trunk-related terms associated with DS1 trunk interfaces.

## **Private network trunks**

---

Tie trunks and tandem trunks are private network trunks. The tie trunks that interconnect the switches of a private network are universal. This means the trunks can be administered with a variety of translation encodes. The originating switch can recognize any start dial signal (precise dial tone, wink start, or delay dial) that the terminating switch sends. If the originating switch does not receive one of these start dial signals, it can be administered to send digits after an administered time-out interval. The time-out interval is the amount of time the originating switch waits before sending digits.

Tie trunks are further classified according to the type of signal (analog or digital) they carry.

## **Analog tie trunks**

Analog tie trunks are communications paths that carry voice and voiceband data communication. The term voice implies that sound is transferred into electrical form and transmitted within an approximate voiceband of 300 Hz to 3,400 Hz. Voiceband data implies that data is transmitted within the voiceband and requires a conversion resource (modem) at both ends of the connection. The data-transmission rate for analog tie trunks depends on the data-handling capability of the modems in the connection.

Other factors that affect the data rate are the number of tie trunks in the connection and the technology of any multiplex systems used in the facilities. Generally, for data rates up to 300 bps, a connection can have five tie trunks in tandem. For data rates greater than 300 bps up to 2,400 bps, a connection can have up to three tie trunks in tandem. For data rates greater than 2,400 bps up to 4,800 bps, a connection can have up to two tie trunks in tandem.

Analog tie trunks, used in unswitched connections, can support up to 9,600 bps.

## **Release Link trunk**

A special type of private network tie trunk is a Release Link Trunk (RLT). RLTs are used between a central or main location and a branch location to provide Centralized Attendant Service. It functions as a one-way outgoing circuit from the

branch locations and a one-way incoming to the main location. RLTs participate in the redirection of incoming calls originally directed to the branch location to attendants at the main location, and handle call completion back to the branch location.

### **Advanced Private Line Termination trunk**

Another special type of trunk is the Advanced Private Line Termination (APLT) trunk. APLT provides access to and termination from CO-based private networks; namely, Common Control Switching Arrangements (CCSA) and Enhanced Private Switched Communications Service (EPSCS). APLT trunks are physically the same as those used for analog tie trunks, where the trunk signaling is compatible with EPSCS and CCSA network switches. The outgoing APLT trunk repeats any number of digits to the private network as dialed. APLT trunks can tandem through the PBX from EPSCS network only; CCSA networks require an attendant to complete the call.

### **Digital Tie trunk**

The digital tie trunk is a high-speed and a high-volume trunk interface to a T1 or E1 carrier. It uses a digital signal (DS1). By multiplexing 24 64-kbps digital channels onto a single 1.544-Mbps T1 carrier, or 32 64-kbps digital channels onto a single 2.048-Mbps E1 carrier, DS1 offers an economical alternative to the analog tie trunk as well as a high-speed fully digital (without modems) connection between the switches.

The maximum per-channel data rate for DS1 is 64 Kbps, and it can carry voice, voiceband data, or high-speed data communications.

### **Digital Multiplex interface**

The DS1 tie trunk is also used for Digital Multiplex Interface Bit-Oriented Signaling (DMI-BOS). DMI-BOS provides high-speed communications over digital transmission facilities between a host computer and a DEFINITY ECS. The DMI-BOS trunk uses the A bit for signaling to provide wink-start dial-repeating into the switch and automatic out or two-way wink start.

## **Public network trunks**

---

Public network trunks are used to connect a private network switch to a public network switch (central office). They can be analog or digital trunks.

In reference to a central office, the term local applies to a switch within the local exchange area. An exchange area has a single-uniform set of charges for telephone service and may be served by more than one CO. Within an exchange area, a call between any two points is a local call.

Public network trunks also function as special access to AT&T Communications (AT&T-C) toll network. AT&T-C provides such services as MEGACOM, MEGACOM 800, and ACCUNET.

## Public network trunks

The following are public network trunks:

- **Central Office (CO) Trunk** — A one-way outgoing, one-way incoming, or two-way trunk. It connects the switch to a CO within the local exchange area. A direct outward dialing (DOD) trunk connects the switch to a CO. These trunks allow terminal (station) users to place calls to a public network central office directly (without attendant assistance).
- **Foreign Exchange (FX) Trunk** — A one-way outgoing, one-way incoming, or two-way trunk. It connects the switch to a CO outside the local exchange area. These trunks give a caller direct access to a central office outside the local exchange area without having to use the public network.
- **Wide Area Telecommunications Service (WATS) Trunk** — A one-way outgoing or one-way incoming trunk. It connects the switch to a CO equipped to handle WATS calls. The outgoing trunks allow a customer, for a monthly charge, to place outgoing station-to-station calls to telephones in a defined service area. The service area has one or more geographic areas known as WATS bands. Incoming trunk calls are completed by the attendant or other service.

A one-way incoming trunk connecting the switch to a CO equipped to handle 1-800 service calls is an inward WATS. For a monthly charge, customers can receive incoming station-to-station calls from telephones in a defined service area without charge to the caller.

- **Direct Inward Dialing (DID) Trunk** — A one-way incoming trunk. It connects the switch to a local CO. These trunks allow calls from the public network to complete to terminals (stations) assigned to a private network switch without attendant assistance.
- **Direct Inward/Outward Dialing (DIOD) Trunk** — A trunk that allows both DID and CO functionality on a single trunk port. On outgoing calls, it is a CO call. On incoming and two-way calls, it is either a DID or CO call. See the appropriate category in this list for further definition.

## Digital public network trunks

The digital public network trunk provides a DS1 interface to the central office over T1 or E1 carrier. The DS1 public network trunk provides an interface to CO, FX, WATS, and DID. The DS1 interface supports incoming and outgoing dial types of ground start, loop start, auto/auto, auto/delay, auto/immed, and auto/wink. Signaling may be robbed-bit or common-channel depending on the trunk type and whether the dial-type is incoming or outgoing. The interface may be used to connect the switch to a toll office directly using wink-start tie trunks for two-way access to the toll network.

## Field descriptions — trunk group forms

---

See the following for descriptions of fields displayed on many of the various trunk group forms. Descriptions are organized by the form they appear on and are listed alphabetically within each form. Fields unique to a particular form are presented under that form.

Page 1 of the form

- **Analog Gain** — Displays if `Country` is **15** and `Trunk Type (in/out)` is **2-wire-ac**, **2-wire-dc**, or **3-wire**. This field allows you to specify a boost in analog gain for the TN2199 port in the direction toward the switch. Enter **a** (-3dB gain boost), **b** (-6dB gain boost), **c** (-8dB gain boost), or **none** (default). This applies *only* to the TN2199 port.
- **Answer Supervision Timeout** — Used for all trunk types, except DID, to indicate the amount of time in seconds the system allows for a call to be answered before beginning a CDR record of a call. This interval begins as soon as the outgoing trunk is seized. Valid entries are **0** to **250**; default is **10**. For OCM applications, set Answer Supervision for trunks supporting network answer supervision to **y**. For trunks that do not receive a real answer, this field determines when the CallVisor Adjunct-Switch Application Interface (ASAI) connect event is sent.



### NOTE:

This timeout does not override answer supervision sent from the network or other firmware (DS1 port circuit timers). DS1 firmware sent answer supervision is administered in `Outgoing End of Dial (sec)` on the Administrable Timers page of the trunk group form.

- **Auth Code** — Only displays if `Direction` is **incoming** or **two-way**. Enter **y** if an authorization code must be dialed to complete incoming calls on the trunk group. This field can only be **y** if `Authorization Codes` is enabled on the System-Parameters Customer-Options form. Default is **n**.
- **Auto Guard** — Enter **y** to prevent repeated seizures of a defective trunk. This field is effective only for TN438B, TN465B, and TN2147 ports. TN438B ports have hardware support for detecting a defective trunk. TN465B and TN2147 ports consider a trunk defective if no dial tone is detected on an outgoing call, and `Outpulse Without Tone` is **n** on the Feature-Related System Parameters form. Default is **n**.
- **BCC (Bearer Capability Class)** — Displays when `Comm Type` is **data**, **avd**, or **rbavd**. Used by the Generalized Route Selection feature and identifies the type of traffic on trunks in the group. The BCC entry is used by far-end tandem switches to select outgoing routing facilities with equivalent BCC classes. Valid entries are **0**, **1**, **2**, **3**, and **4**. Default is **0** for **avd** or **rbavd**, and **2** for **data**.



- **Bit Rate** — Displays when `Comm Type` is **avd** or **rbavd**. It also appears if the `Comm Type` is **data**, but only if `ISDN-PRI` is enabled on the System-Parameters Customer-Options form. Specifies the baud rate to be used by pooled modems. Valid entries are **300**, **1200** (default), **2400**, **4800**, **9600**, and **19200**.
  - **Busy Threshold** — Enter the number of trunk group members that must be busy before the attendant is alerted by the Warning lamp on the Attendant Console. For a TN790, the default is **99**. For a UN331B, the default is **255**.
  - **Call Still Held** — Enter **y** to prevent call collisions by not allowing an outgoing seizure for a period of not less than 140 seconds. This field is used only at the end of an incoming call where the disconnect is initiated by the switch. It effectively will extend the Incoming Glare Guard timer by 140 seconds. This field is effective only for TN438B, TN465B, and TN2147 ports and is used primarily when `Country Code` is 2. Default is **n**.
  - **CDR Reports** — Valid entries are:
    - **y** (default) — CDR records will be generated by completed outgoing calls terminated on this trunk group. If incoming calls are being recorded (`Record Outgoing Calls Only` on the CDR System Parameters form is **n**), then a single CDR record will be generated for answered calls with the call duration.
    - **n** — no CDR records will be generated by calls originated by or terminated on this trunk group.
    - **r** (ring-intvl) — CDR records will be generated for both incoming and outgoing calls. In addition, the following ringing interval CDR records are generated:
      - Abandoned calls — A condition code of “H” is generated indicating the time until the call was abandoned.
      - Answered calls — A condition code of “G” is generated for the interval of start of ring to answer.
      - Calls to busy stations — A condition code of “I” is generated with a recorded interval of 0.
-  **NOTE:**  
For ISDN trunk groups, the `Charge Advice` field affects CDR information. For CO, DIOD, FX, and WATS trunk groups, the `Analog PPM` field affects CDR information.
- **CO Type** — Displays when `Country` is **14** and is applicable only if the trunk group members are administered on a TN464D vintage 2 or greater. This field specifies the type of CO the trunk group is attached to. Valid entries are **analog** (default) and **digital**.

- **Comm Type** — Indicates if the trunk is to be used for voice, data, alternate voice-data (avd), or alternate voice/voice grade data and 56-kbps digital data (rbavd) calls. Valid entries are **avd**, **rbavd**, **voice** (default), or **data**. Type **rbavd** supports access to voice/data SDN service on robbed-bit transmission facilities.

 **NOTE:**

Comm Types of **avd** and **rbavd** require trunk member ports on a DS1 circuit pack. An **rbavd** type requires that the DS1 circuit pack be administered for robbed-bit, or (if mixed mode signaling is allowed on the DS1 circuit pack) ISDN-EXT, or ISDN-PRI. An **avd** type requires that the DS1 circuit pack be administered for either common-chan or CAS signaling.

- **Connected to Toll** — Indicates a loss plan. Enter **y** if connected to a CO toll office. This field displays when `Trunk Type` contains an entry of **auto/...**, **delay/...**, **wink/...**, or **immed/...**. If **n**, `STT Loss` displays.
- **COR** — Enter a class of restriction (COR) number (**0–95**) that reflects the desired restriction; default is **1**.
- **Country** — This field specifies the Country Code for each subscriber line. Valid values are any number between **1–23**, inclusive. The value of this field, in conjunction with the values of `Trunk Termination` and `Trunk Gain`, determines the input and trans-hybrid balance impedance requirements for TN465B, TN2146, and TN2147 ports.
  - If `Country` is **18**, DEFINITY ECS can be administered for Public Network Call Priority (Mode of Release Control, Forced Disconnect, and Rering).
  - If `Country` is **11**, DEFINITY ECS is administered for Public Network Call Priority (Call Retention and Rering).
  - If `Country` is **15**, DEFINITY ECS is administered for Public Network Call Priority (Intrusion and Rering). Also, `Protocol Type` appears for Group Type DID or DIOD.
  - If `Country` is **23** and `Group Type` is either **CO** or **DID**, DEFINITY ECS is administered for Block Collect Calls.
  - If `Country` is **14**, `CO Type` appears for Group Type DID or DIOD.
- **Cut-Through** — Displays when `Outgoing Dial Type` is either **rotary** or **tone**. Enter **y** to allow “cut-through” to the CO trunk.

If the dialed digits are restricted:

- The connection to the CO trunk is dropped.
- Intercept treatment is applied.

Enter **n** (default) and the user will receive switch dial tone. Instead of digits being sent to the CO as they are dialed, they are collected, checked for restrictions, and, if there are no restrictions, the digits are sent to the CO.

- **Cyclical Hunt** — Displays when `Direction` is **two-way** and `Trunk Type` is **loop-start**. Enter **y** (default) if a preferential hunting algorithm is to be used. Otherwise, a linear hunting algorithm will be used.
- **Dial Access** — Enter **y** to allow the trunk group to be accessed via a TAC. Access via the ARS feature is allowed regardless of this entry. Default is **n**.
- **Dial Detection** — Applies only to TN2199 ports. Enter **A-wire** (default) or **B-wire**, as appropriate. The `Country` field must be **15**.
- **Digit Absorption List** — Enter a digit list absorption number, if required, when this trunk group terminates at a step-by-step office. This field specifies the type of absorption as specified on the System Digit Absorption form. Up to five different forms (lists 0 to 4) may be administered. Default is blank.
- **Digit Treatment** — Indicates if digits are to be absorbed or inserted. A blank indicates no digit absorption or insertion. Valid entries are **absorption** or **insertion**, or leave blank. If you enter **absorption** or **insertion**, then you must enter a value in `Digits`.



**NOTE:**

DCS features that use the remote-tgs button (on the remote switch) do not work when the local trunk group deletes or inserts digits on the incoming call. These buttons try to dial a local TAC. Adding or deleting digits defeats this operation and renders the remote feature inoperable. If digit manipulation is needed, use it on the outgoing side, based on the routing pattern. One reason for digit manipulation is insertion of the AAR feature access code (FAC).

- **Digits** — Indicates the digits to be inserted or number of digits to be absorbed. This field is used with `Digit Treatment`; if `Digit Treatment` is not blank, then this field cannot be blank. No entry indicates that no digit absorption or insertion is done. Valid entries are the number of digits to be absorbed (**1–5**) or the actual digits to be inserted (up to 4 digits including the characters **\*** and **#**).
- **Direction** — Enter whether the trunk group is **incoming**, **outgoing**, or **two-way** (default). Note `Direction` administered affects which timers appear on the Administrable Timer page.
- **Disconnect Supervision-In** — Displays when `Direction` is either **incoming** or **two-way**. Default is **y**. Internally, the field is set to **n** if `Direction` is **outgoing**. Enter **y** to indicate that the far-end has the ability to release a trunk when the calling party releases from a call and the system is able to recognize the release signal.
- **Disconnect Supervision-Out** — Displays when `Direction` is either **outgoing** or **two-way**. Default is **n**. Internally, the field is set to **n** if `Direction` is **incoming**. If the field is set to **y**, a warning message appears to alert the user of possible trunk lockups. This field specifies whether trunks in this trunk group provide disconnect supervision when seized outgoing (that is, whether these trunks should be allowed to

participate in outgoing trunk to outgoing trunk calls). This field is set independently of the trunk-to-trunk transfer system parameter, although both options must be set appropriately if outgoing trunk to outgoing trunk transfers are desired.

- **Disconnect Timing (msec)** — Specifies the minimum time period in ms that is required for recognition of disconnect by the serving central office or far-end switch. The time interval must be in increments of 10 (from **140–2550** ms); default is **500**. This timer is not used for ports on a circuit pack that can receive the administrable Incoming Disconnect and Outgoing Disconnect timers. These latter two timers replace the former.
- **Disconnect Type** — Displays only if `Country` is **15** and `Trunk Type` is **2-wire-ac**, **2-wire-dc**, or **3-wire**. This field indicates which side or user controls the disconnect, where A refers to the *calling* party and B refers to the *called* party. Enter **AandB** or **AorB** (default). This applies *only* to the TN2199 port.
- **Drop Treatment** — Setting to **intercept** indicates that intercept tone is applied on the talk path of DID calls dropped by the terminating party when the originating party is still on the call. Entering **busy** indicates busy tone will be applied, and **silence** (default) indicates no tone will be applied.

**NOTE:**

In Italy, `Drop Treatment` must be administered as **intercept** for all DID trunk groups.

- **DTT to DCO Loss** (Digital Tie to Digital CO Trunk Loss) — Specifies the loss plan used for the trunk group that connects a DIU-CO (Digital Interface Unit at a Central Office) to a DIU-DTT (Digital Interface Unit for a Digital Tie Trunk Interface). Displays when `Trunk Type` is **auto/...**, **delay/...**, **wink/...**, or **immed/..**

This option affects the transmission performance of public network access via a private switch network. Enter **low** if private network users complain about too much loss on calls to the public network, otherwise, **normal** should be used. Valid entries are **normal** (default) and **low**. The entry is based on the following:

- **normal** — Corresponds to a (0, -6) dB gain pair and is used as the default option. (This corresponds to the DTT/EIA DCO port to port configuration as described in *DEFINITY Communications System Generic 1 and System 75 and System 85 DS1/DMI/ISDN-PRI Reference*.)
- **low** — Corresponds to (+3, -3) dB gain pair. Low is used for internetwork applications in which no significant configuration will encounter echo, stability, or overload problems because of reduced loss. With the low gain pair, subscriber station DTMF signals transmitted through the digital class 5 office into the customer network may experience non-recoverable digit mutilation in secondary signaling applications (that is, DTMF signaling after

the connection has been established). (This corresponds to the DTT/ISL DCO port to port configuration as described in *DEFINITY Communications System Generic 1 and System 75 and System 85 DS1/DMI/ISDN-PRI Reference*.)

- **Duplex** — Displays when `Comm Type` is **avd** or **rbavd**. It also appears if `Comm Type` is **data**, but only if `ISDN-PRI` is enabled on the System-Parameters Customer-Options form. Specifies either full or half duplex for the trunk group. Valid entries are **full** (default) or **half**.
- **Expected Digits** — Only displays if `Trunk Signaling Type` is left blank, `Direction` is **incoming** or **two-way**, and `Incoming Dial Type` is **mf**. This field specifies the number of digits that the far-end sends for an incoming connection. If `Digit Treatment` is **absorption**, this field must have a value greater than that in `Expected Digits`. Valid values are between **1** and **18** inclusive.

⇒ **NOTE:**

When you leave `Expected Digits` blank, you cannot administer digit absorption

- **Group Name** — Enter a unique name that identifies the trunk group. Up to 27 characters can be used; default is **OUTSIDE CALL**.
- **Group Number** — Enter a group number when completing a paper form. This is a display-only field when the form is accessed using an administration command such as **add** or **change**.

⇒ **NOTE:**

When supporting DCS, it is required that the far-end node trunk group be assigned the same group number.

- **Group Type** — Enter the trunk group type.

⇒ **NOTE:**

A Group Type of `isdn-pri` can be entered only if `ISDN-PRI` or `ISDN-BRI Trunks` on the System-Parameters Customer-Options form has been enabled.

- **Incoming Destination** — Displays when `Direction` is **incoming** or **two-way**. Indicates where incoming calls will terminate. Valid entries are an extension number, the attendant group access code (**attd**), **VDN**, or leave blank if `Trunk Type (in/out)` is not **auto/...** If **attd** is entered, a call is treated as a Listed Directory Number (LDN) call.
- **Incoming Dial Tone** — Indicates whether or not the trunk group will pass on incoming dial tone to the calling party. Valid entries are **y** (default) or **n**.
- **Incoming Dial Type** — Indicates the type of pulses required on an incoming trunk group. If using Inband ANI feature, enter **tone**. Valid entries are **tone** (default), **rotary**, or (if `Trunk Signaling Type` is blank), **mf**.

⇒ NOTE:

The `Multifrequency Signaling` field must be enabled on the System-Parameters Customer-Options form before a value of `mf` may be administered.

The `Incoming Dial Type` field may not be `mf` if `Used for DCS` (Page 2 of the form) is `y`.

The value in this field impacts the appearance of `Incoming Partial Dial (sec)` on the `Administrable Timer Page`.

- **Incoming Rotary Timeout (sec)** — The timing interval required by the far-end to which the system is connected. If the system is connected to a Step-by-Step office, 18 seconds or more must be used; if the system is not connected to a Step-by-Step office, 5 seconds or more may be used. Valid entries are **5** through **99**, or blank; default is **5**.
- **ITC** (Information Transfer Capability) — Displays when `Comm Type` is **data**, **avd**, or **rbavd** and `BCC` is not **0**. Used by the GRS feature and enables the system to route calls to restricted (default) or unrestricted facilities according to the endpoint's information transfer capability. A trunk member is said to be restricted if the circuit pack it belongs to is administered as **ami-bsic** or **ami-zcs** in `Line Coding` of the DS1 form. A trunk member is said to be unrestricted if the circuit pack it belongs to is administered as **b8zs** or **hdb3** in `Line Coding` of the DS1 form. A restricted trunk member can carry only restricted calls. An unrestricted trunk member may carry restricted or unrestricted calls. A trunk group with a transfer capability of **unrestricted** may have only unrestricted trunk members.
- **Night Service** — Enter the extension number assigned to Night Service. The extension number entered receives all incoming calls when Night Service is activated and the individual trunk member `Night` field is not administered to override this group extension. Valid entries are an extension number (can be a VDN extension), the attendant group access code (**attd**), or leave blank (default) if `Trunk Type (in/out)` is not **auto/...**

⇒ NOTE:

The following trunk groups do not support night service: CPE, DID, and DIOD.

- **Outgoing Dial Type** — Identifies the type of pulsing required on an outgoing call. Valid entries are **tone** (default), **rotary**, or (if `Trunk Signaling Type` is blank) **mf**.

⇒ NOTE:

`Multifrequency Signaling` must be enabled on the System-Parameters Customer-Options form before a value of `mf` may be administered.

Outgoing Dial Type may not be set to **mf** if Used for DCS (Page 2 of the form) is **y**.

- **Outgoing Display** — Specifies whether the trunk group name displays on a terminal placing an outgoing call. It controls what displays before the call is connected. Valid entries are **y** or **n** (default). When **n**, the dialed number displays. When **y**, the trunk group name and number replace the dialed number.
- **Prefix-1** — Indicates if the prefix 1 is required for NXX FNPA calls (where N is 2 through 9, and X is 0 through 9). Valid entries are **y** (default) and **n**.
- **Protocol Type** — For DID and DIOD trunk groups. Only displays when `Country` is **15** and is applicable only if the trunk group members are administered on a TN2199 or TN464D vintage 3 or greater. This field specifies the type of line signaling protocol (Incoming Local or Incoming Toll) to be used. Valid entries are **inloc** (default) and **intol**. Only the inloc protocol provides ANI.
- **Queue Length** — Only displays when `Direction` is **outgoing** or **two-way**. Enter the number of outgoing calls that can be held waiting. A **0** (default) indicates that no calls are held in queue. Enter **0** for DCS trunks. Valid values are **0-100**. This field turns off if `Direction` is **incoming**.
- **RA Trunk Loss** (Remote Access Trunk Loss) — Displays when `Terminal Balanced` is **n**. Specifies the type of dB loss to be applied to non-terminally balanced trunks. If experiencing unsatisfactory echo performance (hollowness), enter **2dB**. Valid entries are **0db** (default) and **2db**.
- **Receive Answer Supervision** — Specifies whether the network provides answer supervision for the trunks. Answer supervision refers to notification from the far-end that the called party has gone off-hook to answer the call. When answer supervision is not provided, the originating switch can classify a call as answered using the `Answer Supervision Timeout` field entry (for domestic circuit packs) or, for circuit packs that take administrable timers, by using `Outgoing End of Dial (sec)`. For trunks over which answer supervision is provided by the network, set this field to **y** (default) and `Answer Supervision Timeout` to **0** to disable the firmware timeout. The firmware timeout is set automatically to **0** on circuit packs that take the administrable `Outgoing End of Dial (sec)` field. Receive Answer Supervision must be **n** if `Direction` is **incoming**.
- **Receive Release Ack** — Displays only when `Trunk Signaling Type` is either **cont** or **dis**. (Thus, this field only applies to TN2140 ports.) Enter **y** (default) if the switch should expect to receive a release acknowledgment in response to a forward or backward release signal.
- **Send Answer Supervision** — Displays when `Trunk Signaling Type` is **cont** or **dis** and only applies to TN2140 ports. Enter **y** (default) if the switch should signal that the destination party has answered.

- **Send Release Ack** — Displays when `Trunk Signaling Type` is **cont** or **dis** and only applies to TN2140 ports. Enter **y** (default) if the switch must send a release acknowledgment in response to a forward or backward release signal.
- **Sig Bit Inversion** — This field allows the user to administer the signaling bit inversion (the A-bit and B-bit inversion) on a per-port basis and applies only to TN464B or later circuit packs. The CCITT standards define on-hook to be “1” in the A-bit and off-hook to be “0.” This definition is the opposite of the EIA definition. The default in the TN464 firmware for signaling bit inversion is to use the CCITT standard for 32-channel mode and to use the EIA standard for 24-channel mode. Valid entries are **A**, **B**, **A&B** and **none** (default).
- **STT Loss** (Satellite Switch Tie Trunk Loss) — Displays when `Connected to Toll` is **n**. Specifies the loss plan to be used for the trunk group. Valid entries are **normal** (default) or **low**. This option affects the transmission performance of a private network.

Although the use of this option has wider applications, only for the simplest network arrangements (such as co-located DCS) should this field be administered without Network Engineering advice. The **low** option (described as the ISL digital low loss plan in *DEFINITY Communications System Generic 1 and System 75 and System 85 DS1/DMI/ISDN-PRI Reference*) should be used when:

1. Stations on the satellite switch complain of too much loss on calls to the public network.
2. The network consists of **no more** than three switches: one main and one or two satellite switches.
3. All switches have the **low** option available.
4. The total DS1 trunk connection length is less than 100 miles.

If the preceding conditions are not met, obtain Network Engineering assistance. The field entry is based on the following:

- **normal** — Applies to AIU-TT (Analog Interface Unit at Customer Switching System for Tie Trunk — 4-wire E&M interface), and DIU-TT (Digital Interface Unit at Customer Switching System for Tie Trunk — voice or AVD DS1 interface) loss plans.
  - **low** — Applies to AIU-TTS (same as AIU-TT, but suitable for private network connections that can be connected in tandem with public network connections) and DIU-TTS (same as DIU-TT, but suitable for private network connections that can be connected in tandem with public network connections). These interfaces were formerly referred to as DIU DTT ISL.
- **Synchronization** — Enter whether the trunk group will use synchronous or asynchronous communications. Valid entries are **async** (default) and **sync**.
    - Displays when `Group Type` is **dmi-bos** or **isdn-pri**.



- Displays when `Group Type` is **access**, **co**, **fx**, **tandem**, **tie**, or **wats** and `Comm Type` is **avd** or **rbavd**.
- Displays when `Group Type` is **access**, **co**, **fx**, **tandem**, **tie**, or **wats**, `Comm Type` is **data**, and `ISDN-PRI` or `ISDN-BRI Trunks` is enabled on the `System-Parameters Customer-Options` form.
- **TAC** — Enter the trunk access code (TAC) that must be dialed to access the trunk group. CDR also uses the TAC to identify the trunk group on associated CDR reports. A different TAC must be assigned to each trunk group. Valid entries are TACs that are compatible with the System Dial Plan (1–4 digits; 1–3 digits for DCS or to remotely control it).
- **Terminal Balanced** — Displays when `Trunk Type` is **ground-start**, **loop-start**, **immed-start**, or **wink-start**. Enter **y** for terminally balanced trunks or **n** (default) for unbalanced trunks. Typically, a `Trunk Termination` field of **600ohm** signifies a balanced trunk group and a field of **rc** signifies a non-balanced trunk group. If the trunks in this group pass the Low Frequency Return Loss test requirements, then they are terminally balanced, and this field should be **y**.
- **TN** — Enter the Tenant Partition number. For TN790 (Release 6si and later configurations), valid values are **1–20**. For UN331B (Release 6r and later configurations), valid values are **1–100**. Default is **1**.
- **Toll Restricted** — Enter **y** (default) if this trunk group is to be toll restricted. This field only applies for outgoing TAC calls if the originating party is toll restricted. Trunks with an `Outgoing Dial Type` field of **automatic** should have this field set to **n**.
- **Trunk Flash** — Enter **y** or **n** (default) to indicate if access to customized services provided by a far-end (such as Central Office) is permitted for this trunk group. The switch must be directly connected to a far-end that provides such services via an analog or digital trunk.
- **Trunk Gain** — This value specifies the gain of the trunk, and can be **high** (default) or **low**, in conjunction with the values of `Trunk Termination` and `Country`, determine the input and trans-hybrid balance impedance for TN465B, TN2146, TN2147, and TN2184 ports. All other CO and DID circuit packs are set automatically to **high**.
- **Trunk Signaling Type** — Specifies the kind of signaling to use for members in the trunk group, and if administered to a non-blank value, severely restricts the ports that can be administered in the trunk group.

Valid values are **cont** (continuous), **dis** (discontinuous), or blank (default). Entering one of these values indicates that only ports from a TN2140 Italian tie trunk may be administered as trunk group members. Entering one of these values causes `Send Release Ack`, `Receive Release Ack`, and `Send Answer Supervision` to appear. If the field is blank, ports from any other Tie trunk circuit pack may be added as trunk group members.

If `Group Type` is **tie**, valid values include **tge**, **tgi**, and **tgu**. Entering one of these three values indicates that only ports from a TN497 Italian Tie trunk can be administered as trunk group members.

 **NOTE:**

The value in this field also affects which timers will appear on the Administrable Timer Page.

- **Trunk Termination** — Specifies how the trunk group is terminated. Valid entries are **600ohm** or **rc** (default). Enter **600ohm** when the switch trunk port is connected to terminal equipment (for example, SLC carrier or compensators optioned for 600 ohms input impedance) and the distance to the terminal equipment from the switch is less than 3000 feet.
- **Trunk Type** — Identifies the physical type of trunk. It may differ for incoming and outgoing types. Valid entries are **ground-start**, **loop-start**, **auto/auto**, **auto/delay**, **auto/immed**, and **auto/wink**. If `Country` is **15**, additional valid entries are **2-wire-ac**, **2-wire-dc**, and **3-wire**. These three trunk types must be on a TN2199 circuit board.
- **Trunk Type (in/out)** — Identifies the physical type of incoming and outgoing trunks. The trunks may be automatic, immed-start, wink-start or delay-dial; additionally, they may be **cont** (continuous-seize-ack) if `Trunk Signaling Type` is **cont**; if `Trunk Signaling Type` is **dis**, only **disc** (discontinuous-seize-ack is used instead of **wink**) and **immed** are allowed. It may differ for incoming and outgoing directions.
- When the `Trunk Signaling Type` is **dis**, the valid values are **immed** and **disc**:

disc/disc | disc/immed | immed/disc | immed/immed

When the `Trunk Signaling Type` is “cont,” the valid values are:

|            |            |             |             |            |
|------------|------------|-------------|-------------|------------|
| auto/auto  | auto/cont  | auto/delay  | auto/immed  | auto/wink  |
| cont/auto  | cont/cont  | cont/delay  | cont/immed  | cont/wink  |
| delay/auto | delay/cont | delay/delay | delay/immed | delay/wink |
| immed/auto | immed/cont | immed/delay | immed/immed | immed/wink |
| wink/auto  | wink/cont  | wink/delay  | wink/immed  | wink/wink  |

Otherwise, the valid values are:

|            |             |             |            |
|------------|-------------|-------------|------------|
| auto/auto  | auto/delay  | auto/immed  | auto/wink  |
| delay/auto | delay/delay | delay/immed | delay/wink |
| immed/auto | immed/delay | immed/immed | immed/wink |
| wink/auto  | wink/delay  | wink/immed  | wink/wink  |

⇒ NOTE:

For **immed/immed** trunks (on incoming trunks), the far-end switch seizes the trunk and then sends digits without waiting for acknowledgment from the receiving switch. When heavily loaded, the receiving switch may incur a short delay in attaching a Touch Tone Receiver to this call and, therefore, cause it to lose digits. Using wink-start trunks or increasing the dial-guard timer value on the far-end switch avoids this problem.

- **Version** — Displays only if `Country` is **5**. The Version indicates the type of signaling to be used and applies only to TN2147 ports. Enter **a** (default) if `Country 5` signaling is to be used. Enter **b** if `Country 1` signaling is to be used. The value **b** is appropriate if connected to an Ericsson AXE-10 switch.
- **Wink Timer (msec)** — Displays when the trunk type for the “outgoing” side of the in/out field is **wink** or **delay**. Enter a number from **300** (default) to **5000** in increments of 50. This timer is sent only to TN760C (vintage 4 or later), TN767, and TN464C (or later) circuit packs.

⇒ NOTE:

This value is the same for each member of the trunk group where the timing is administered. That is, if members from TN760B ports are mixed with members from TN760C V4 ports, only the TN760C V4 ports are set to this value. (The TN760B ports use a default value on the circuit pack itself.)

United States domestic requirements state that for a “wink” start trunk, the wink must begin within five seconds (the “wait-for-wink-to-start” time) and must end within 290 ms (the “wait-for-wink-to-end” time). For a “delay” dial trunk, the wink must begin within 140 ms (the “wait-for-wink-to-start” time) and end when the switch is ready to receive digits.

For trunk types with an outgoing type Wink, the call is rejected if the wink starts more than 5 seconds after the seize, and if the wink lasts longer than the wink timer setting.

For trunk types with an outgoing type Delay, the Delay Dial signal is ignored if it starts after the wink timer setting after the seize, and if it lasts longer than 5 seconds.

Page 2 of the form

- **Abandoned Call Search** — Administered when `Trunk Type` is **ground-start**. Enter **y** if this trunk group will conduct an Abandoned Call Search to identify a ghost call.

⇒ NOTE:

Abandoned Call Search is designed to work with CO trunks (ground start - analog) that *do not* provide disconnect supervision. Central offices that provide disconnect supervision do not require use of the Abandoned Call Search feature. The CO must support Abandoned Call Search for the feature to work properly.

- **ACA Assignment** — Specifies whether Automatic Circuit Assurance (ACA) measurements will be taken for this trunk group. Valid entries are **y** or **n** (default). If **y** is entered, complete the **Long Holding Time**, **Short Holding Time**, and **Short Holding Threshold** fields.
- **Charge Conversion** — Displays when **Direction** is **outgoing** or **two-way**. For ISDN trunk groups, it displays when **Charge Advice** is *not none*. Used to set the value of a charge unit in terms of currency. DEFINITY ECS multiplies the number of charge units by the value of this field and displays it as a currency amount. If there is no value in this field, DEFINITY ECS displays the number of charge units without conversion to currency. Valid entries are from **1–64,500**. Default is **1**.
- **Charge Type** — Displays when **Direction** is **outgoing** or **two-way**. For ISDN trunk groups, it displays when **Charge Advice** is *not none*. Entry in this field displays on the end-user voice-terminal display. It is a text string you use to describe charges related to a phone call. Default is **units**.
- **Connected to CO** — Displays when the software is R6 or later configurations and **Group Type** is **tie**. Permits overlap sending to a Central Office. Valid entries are **y** and **n** (default).
- **Currency Symbol** — Displays when **Direction** is **outgoing** or **two-way**. For ISDN trunk groups, it displays when **Charge Advice** is *not none*. Entry in this field displays on the end-user voice-terminal display. It is a symbol you want to display in front of the charge amount. Valid values are any character (to a maximum of 3) that you can enter from your keyboard. The default is blank.
- **Data Restriction** — Used to prevent features from generating tones on a data call that would cause erroneous data transmission. Valid entries are **y** or **n** (default).
- **Decimal Point** — Displays when **Direction** is **outgoing** or **two-way**. For ISDN trunk groups, it displays when **Charge Advice** is *not none*. Entry in this field displays on the end-user voice-terminal display. You use it to set a decimal point indicator. Valid values are **comma**, **period**, or **none** (default).
- **Glare Handling** — Only displays when **Direction** is **two-way** and the outgoing side of **Trunk Type** is either **wink** or **delay**. This field determines how glare situations should be treated. Valid entries are **control**, **backoff**, or **none** (default).

Warnings are generated if the field is changed to either **control** or **backoff** and ports for the trunk group are not capable of detecting glare. The following circuit packs can detect glare situations: TN767 (all releases), TN760C (or later releases), and TN464C (or later releases).

- **Incoming Tone (DTMF) ANI** — Displays only when `Incoming Dial Type` on page 1 is **tone**. Valid entries are **\*ANI\*DNIS\***, **ANI\*DNIS\***, or **no** (default).

With the **\*ANI\*DNIS\*** option, the far end must provide a leading “\*.” With the **ANI\*DNIS\*** option, the far end does not provide a leading “\*.”

These ANI digits are printed on a CDR record, passed to the Audix Intuity and ASAI interface, and displayed on the station set (and on tandem calls if the outgoing trunk requires ANI). Then this received ANI is sent to the outgoing trunk.

- **Internal Alert** — Specifies if internal ringing and coverage will be used for incoming calls. Valid entries are **y** or **n** (default).
- **Long Holding Time (hours)** — Displays only when `ACA Assignment` is **y**. This field is the length (in hours) that the system will consider as being a long holding time. If **0** is entered, the system will not consider long holding calls. Valid entries are **0** to **10**; default is **1**.
- **Maintenance Tests** — Indicates whether hourly maintenance tests will be made on this trunk group. Valid entries are **y** (default) or **n**.



**NOTE:**

The value administered is not saved when the form is submitted unless one or more trunk members are administered.

- **Measured** — Indicates if the system will transmit data for this trunk group to the Call Management System (CMS). Valid entries are **internal**, **external**, **both**, or **none** (default). Enter **internal** if the data can be sent to the Basic Call Management System (BCMS) [which is internal to the switch] the VuStats data display, or both. Enter **external** to send the data to the CMS adjunct. Enter **both** to collect data internally and to send the data to the CMS adjunct reports. Enter **none** if trunk group measurement reports are not required. Note that you cannot use **internal** and **both** unless either `BCMS (Basic)` or `VuStats` is enabled on the System-Parameters Customer-Options form.
- **PBX ID** — Displays when `Used for DCS` is **y**. Enter the ID of the switch at the other end of this trunk. Identifies the remote switch within the network with which the trunk will communicate on a DCS signaling link. Valid entries are **1** to **63**; default is blank.
- **Per Call CPN Blocking Code** — (For Access, APLT, CO, DIOD, FX, Tandem, Tie, and WATS trunk groups only.) Enter 1 to 4 digit number and \* and # may be used as the first digit.

- **Per Call CPN Unblocking Code** — (For Access, APLT, CO, DIOD, FX, Tandem, Tie, and WATS trunk groups only.) Enter 1 to 4 digit number and \* and # may be used as the first digit.
- **Receive Analog Incoming Call ID** — Delays ringing on the trunks to collect Incoming Call Line Identification (ICLID) information. This field displays when the Analog Trunk Incoming Call ID field on the System-Parameters Customer-Options form is **y**, Group Type field on the Trunk Group form is **co**, **did**, or **diod**, and the Direction field is **incoming** or **two-way** (the Direction field on DID trunks does not display because all calls are incoming; on DIOD trunks, it defaults to **two-way**). Valid entries are **Bellcore** (used for U.S.), **NTT** (used for Japan), and **disabled** (default).
- **Request Category** — Displays when Country is **15** and Shuttle is **y**. Enter **y** when the switch should request a call category from the CO. Default is **n**.
- **Seize When Maintenance Busy** — This field is effective only for ports on TN760C (or later release), TN767, and TN464C (or later release) circuit packs. It indicates whether an outgoing seize is generated when a trunk is maintenance busied, and whether the far-end switch is administered to do likewise. This supports the Electronic Tandem Network Busyout feature. The intended use of this feature is to prevent the far-end switch from reporting problems concerning a trunk that has been removed from service at the near end. The setting of this field has no effect on the behavior of the far-end machine; it controls the behavior of the near end switch and the *expected* far-end behavior.

If the administered value of this field is either **near-end** or **both-ends**, an outgoing seize will be initiated whenever a trunk in this trunk group is maintenance busied. The seize is maintained until the maintenance busyout is released. This action will likely cause alarms at the far-end switch, perhaps leading to a far-end maintenance busy out, unless the far-end switch is administered to expect this behavior.

If the administered value of this field is either **far-end** or **both-ends**, any abnormally long incoming seize (including failure to drop from a completed call) is *assumed to be the result of a far-end maintenance busy condition*.

Note that this assumption may be incorrect, since the abnormally long seize may actually be due to a transient or permanent failure of the trunk circuit. Regardless of the cause of the abnormally long seize, the near end response is to:

1. Generate a warning alarm indicating that the trunk is assumed to be maintenance busy at the far-end,
2. Remove the trunk from service, and
3. Keep the trunk out of service until a far-end disconnect is received.

The values allowed depend on Direction. When Direction is **incoming**, the valid values are **far-end** and **neither-end**.

When *Direction* is **outgoing**, the valid values are **near-end** and **neither-end**.

When *Direction* is **two-way**, the valid values are **both-ends**, **far-end**, **near-end**, and **neither-end**.

- **Short Holding Threshold** — Displays when *ACA Assignment* is **y**. Number of times the system records a short holding call before an attendant is alerted to the possibility of a faulty trunk. Valid entries are **0** to **30**; default is **15**.
- **Short Holding Time (seconds)** — Displays when *ACA Assignment* is **y**. Specifies the length (in seconds) that the system considers as being a short holding time. If **0** is entered, the system will not consider short holding calls. Valid entries are **0** to **160**; default is **10**.
- **Shuttle** — Displays when *Country* is **15** and *Outgoing Dial Type* is **rotary**. Enter **y** to enable MF shuttle signaling. Default is **n**. Can be administered on TN 464D (or later release) or TN2199 circuit packs.
- **Start B Signal** — Displays when *Country* is **15** and the *Shuttle* field is **y**. Enter **1 - 3** to indicate which B signal should be used to start a call. Default is **1**. Each of the three entries are described below:
  - **1** = Start calls with signal B1 (first digit)
  - **2** = Start calls with signal B2 (next digit)
  - **3** = Start calls with signal B3 (previous digit)

The value administered in this field must be coordinated with the CO-equivalents of *Start Position*.

- **Start Position** — Displays when *Country* is **15** and *Shuttle* is **y**. Enter **1 - 9** to indicate which digit in the digit string is considered to be the “previously sent” digit. Values and their meanings must be agreed upon by the system administrator and the CO. Default is **1**.
- **Suppress # Outpulsing** — Indicates end-to-end signaling begins with (and includes) the “#” when **y** is entered here. The final “#” is suppressed in cases where the system would normally outpulse it. This field should be **y** when the Central Office (for example, rotary) or any other facility treats “#” as an error; default is **n**.
- **Used for DCS** — Specifies whether the trunk group will send and receive messages on a DCS signaling link. Valid entries are **y** or **n** (default). If this field is **y**, you can administer ISDN-BRI trunk groups unless *DCS Signaling* is **d-chan**. In that case, remove the BRI trunks or set *DCS Signaling* to **bx.25** before submitting the form.

 **NOTE:**

This field cannot be activated if the trunk group number is greater than 255 or if the Trunk Access code is more than 3-digits long.

## Administrable Timers form

- **Answer Send (msec)** — Enter the duration (in msec) of the answer signal pulse. This field appears only if `Trunk Signaling Type` is **dis** and the trunk group `Direction` is **incoming** or **two-way**. Valid entries are **10** to **2550** in increments of 10. Default is **80**. Only TN2140 and TN2199 ports receive this timer.
  - **Break (msec)** — Enter the duration of the break interval (the pulse duration) while the system is outpulsing digits using dial pulse signaling.  
  
If `PPS` is **10**, the sum of `Make (msec)` and `Break (msec)` must equal 100. Valid entries are **20** to **80** in increments of 5. The field cannot be blank. The default is **60**.  
  
If `PPS` is **20**, the sum of `Make (msec)` and `Break (msec)` must equal 50. Valid entries are **10** to **40** in increments of 5. The field cannot be blank. The default is **30**.
  - **Disconnect Signal Error (sec)** — Enter the time (in sec) within which a disconnect signal from the far-end is expected after the internal party (a station or a tie trunk) goes on-hook. If the timer expires, the system can assume a disconnect failure and take an appropriate action (such as an error message). This field appears for ground-start trunk groups. Valid entries are **1** to **255** in increments of 1; default is **240**.
  - **Flash Length (msec)** — Specifies the length of the flash signal to be generated toward the Central Office. Valid entries are **10** to **2550** in increments of 10; default is **540**. This timer is sent to TN436B, TN459B, TN464C (or later), TN465B (or later), (TN753 if Country is **23**), TN2146, TN2147, TN2184, and TN2199 circuit boards.
  - **Frequency** — Displays if `Direction` is **outgoing** or **two-way** and `PPM` is **y**. Identifies the PPM pulse frequency(ies). Circuit packs can listen for up to three different frequencies, (12kHz, 16kHz, and 50Hz), plus two frequency combinations, (50Hz/12kHz and 50Hz/16kHz). Valid entries are **12k**, **16k**, **50**, **50/12k** (default), and **50/16k**. This field is sent to the TN465B, TN2138, and TN2184 circuit packs.
-  **NOTE:**  
The TN465B (or later) and TN2184 can only detect 12k and 16kHz PPM. Therefore, if **50/12k** or **12k** is administered, the circuit pack will be set to detect 12kHz. If **16k**, **50**, or **50/16k** is administered, the circuit pack will be set to detect 16kHz.
- **Glare** — Enter the minimum time (in msec) between sending an outgoing seizure and receiving a seizure acknowledgment. If seizure acknowledgment is received before expiration of the timer, a glare condition is assumed. It is only administrable if `Trunk Signaling Type` is **cont** and the trunk group `Direction` is **two-way** or **outgoing**. Valid entries are **40** to **100** in increments of 10. Default is **40**. Only TN2140 ports receive this timer.



- **Incoming Dial Guard (msec)** — Enter the interval between the detection of an incoming seizure and the acceptance of the first digit. The switch will not accept digits before this timer expires. Valid entries are **10–2550** in increments of 10; default is **70**.

 **NOTE:**

This timer is never sent to TN429 ports.

- **Incoming Disconnect (msec)** — A disconnect signal on an incoming call is considered valid only if it continues at least for the time specified by this timer. Valid entries are **50–2550** in increments of 10. The field cannot be blank; default is **500**. The field appears only for an incoming or two-way trunk group when *Trunk Signaling Type* is either blank or **cont**.
- **Incoming Disconnect Send (msec)** — Calls may be cleared by either the calling switch (forward release) or the called switch (backward release). Backward release is signaled by the called switch by grounding the M-lead for the duration specified by this timer. It is only administrable if *Trunk Signaling Type* is **dis** and the trunk group *Direction* is **incoming** or **two-way**. Valid entries are **500–1200** in increments of 100. Default is **800**. Only TN2140 ports receive this timer.
- **Incoming Glare Guard (msec)** — Enter the minimum time (in msec) between the time an incoming trunk is released and the same trunk can be seized for an outgoing call. This guard time ensures the far-end has released all equipment after the incoming trunk is released. Valid entries are **100** to **25500** in increments of 100. The field cannot be blank. Default is **1500**. This field only appears when the trunk group *Direction* is **two-way**.
- **Incoming Incomplete Dial Alarm (sec)** — Enter the maximum time (in sec) allowed between incoming seizure and receipt of all digits. Intervals greater than this generate an inline error. Valid entries are **1** to **255** (default) in increments of 1. Only the TN436 (all), TN459 (all), TN464C (or later), TN760Dv15 (or later), TN767, TN2140, TN2146, TN2184, and TN2199 circuit packs.
- **Incoming Partial Dial (sec)** — Enter the time (in sec) allowed between digits. Valid entries are **5** to **255** in increments of 1; default is **18**. This timer appears only if *Incoming Dial Type* is **rotary**.

 **NOTE:**

This timer is never sent to TN429 ports.

- **Incoming Seizure (msec)** — Enter the minimum time (in msec) required for recognition of incoming ringing signal from the far-end. Valid entries are **20** to **2550** in increments of 10. The field cannot be blank. Default is **500**. This field appears when *Trunk Signaling Type* is **cont** and *Direction* is **incoming** or **two-way**. Only TN429, TN438 (any release), TN 447, TN464C (or later), TN465 (any release), TN767, TN2138, TN2140, TN2147, TN2184, and TN2199 ports receive this timer.

- **Make (msec)** — Enter the duration of the make interval (the pause between pulses) while the system is outpulsing digits using dial pulse signaling.  
  
If PPS is **10**, the sum of Make (msec) and Break (msec) must equal 100. Valid entries are **20 to 80** in increments of 5. The field cannot be blank. The default is **40**.  
  
If PPS is **20**, the sum of Make (msec) and Break (msec) must equal 50. Valid entries are **10 to 40** in increments of 5. The field cannot be blank. The default is **20**.
- **Normal Outgoing Seize Send (msec)** — Outgoing seizure is signaled by the calling switch momentarily grounding the M-lead for the duration specified by this timer. This field appears only if Trunk Signaling Type is **dis** and the trunk group Direction is **two-way** or **outgoing**. Valid entries are **10 to 990** in increments of 10. Default is **70**. Only TN2140 ports receive this timer.
- **Outgoing Dial Guard (msec)** — This timer specifies the minimum time between seizure acknowledgment of a trunk and the outpulsing of digits. For trunks that do not provide seizure acknowledgment, the timer specifies the minimum time between seizure and the outpulsing of digits. Any digit dialed by the station user after they lift the receiver, but before the timer times out, is not outpulsed until the timer expires. Valid entries are **100–25500** in increments of 100. The field cannot be blank. Default is **1600**.
- **Outgoing Disconnect (msec)** — A disconnect signal on an outgoing call is considered valid only if it continues at least for the time specified by this timer. This timer begins timing when a disconnect signal has been detected on an outgoing call over the trunk, and resets when the signal is no longer detected. If the timer times out, the trunk drops. Valid entries are **50 to 2550** in increments of 10. The field cannot be blank. Default is **500**.
- **Outgoing Disconnect Send (msec)** — Forward release is signaled by the calling switch by grounding the M-lead for the duration specified by this timer. It is administrable only if Trunk Signaling Type is “**dis**” and the trunk group Direction is **two-way** or **outgoing**. Valid entries are **100 to 9900** in increments of 100. Default is **800**. Only TN2140 ports receive this timer.
- **Outgoing End of Dial (sec)** — Enter the maximum time (in sec) a trunk may wait for answer supervision after dialing an outgoing call. During a cut-through operation, timing begins after each outgoing digit is sent by the switch and timing ceases after the far-end sends answer supervision. If the timer expires, the switch acts as if it had received answer supervision. On senderized operation, the timer begins after the last digit collected is sent by the switch. The timer ceases when the far-end sends answer supervision. If the timer expires, the switch acts as if it has received answer supervision. This field appears when Direction is **outgoing** or **two-way** and Receive Answer Supervision is **n**. This

field will not appear if `Receive Answer Supervision` is **y**, but a zero (0) value will be sent down to the firmware to disable the timer. Valid entries are **1** to **254** in increments of 1. Default is **10**.

 **NOTE:**

This field controls the firmware answer-supervision timer on ports that take the administrable timers; `Answer Supervision Timeout` on Page 1 of the Trunk Group form controls answer supervision for ports that do not take administrable timers. This field and the value administered in `Answer Supervision Timeout` on the Trunk Group form should be the same value.

- **Outgoing Glare Guard (msec)** — Enter the minimum time (in msec) between the time an outgoing trunk is released and the same trunk can be seized for another outgoing call. This guard time will ensure that the far-end has released all equipment after the outgoing trunk is released. Valid entries are **100** to **25500** in increments of 100. The field cannot be blank. Default is **1500**. This field only appears for **outgoing** and **two-way** trunk groups.
- **Outgoing Last Digit (sec)** — Enter the maximum time (in seconds) to wait for the next digit dialed. After the timer expires, no more digits are accepted by the circuit pack. It will only be administrable if `Trunk Signaling Type` is **dis** or **cont** and the trunk group `Direction` is **two-way** or **outgoing**. Valid entries are **1** to **40**; default is **10**. Only TN497 and TN2140 ports receive this timer.
- **Outgoing Rotary Dial Interdigit (msec)** — Enter the interval (in msec) between rotary dial digits being outpulsed by the switch. Valid entries are **150** to **2550** in increments of 10. The field cannot be blank. Default is **800**. This field only appears when `Outgoing Dial Type` is **rotary**.
- **Outgoing Seizure (msec)** — Displays when `Country` is **15**, `Direction` is **outgoing** or **two-way**, and `Trunk Type` is **2-wire-ac**, **2-wire-dc**, or **3-wire**. This timer specifies the duration (in milliseconds) of the outgoing seizure signal. Enter a number between **20** and **2550** in increments of 10; default is **200**. This timer is sent only to the TN2199 circuit pack.
- **Outgoing Seizure Response (sec)** — Enter a maximum time (in sec) by which the switch should receive the proceed-to-dial indication from the far-end after sending the seize signal. If the indication is not received in this time, a seizure failure response is uplinked. Valid entries are **1** to **255** in increments of 1. Default is **5**. This timer is sent to the TN438B, TN439, TN447, TN458, TN464B (or later), TN465B (or later), TN760Dv15 (or later), TN767, TN2140, TN2147, TN2184, and TN2199 circuit packs.
- **Pause (msec)** — Enter the minimum length of a pause between tones being sent in response to button depressions at a hybrid station set. It is administrable only if the `Trunk Signaling Type` is blank. Valid entries are **20** to **2550** in increments of 10; default is **150**. All CO, DIOD, and Tie circuit packs that accept administrable timers accept this timer. However, this

timer is sent only to the following DID circuit packs: TN464B (or later), TN767, TN436B, TN459B, TN2146, TN2199, and TN429 and TN2184 ports in a DID trunk group.

- **PPM** — (For CO, DIOD, FX, PCOL, and WATS trunks.) Appears for outgoing and two-way CO trunks. Enter **y** if Periodical Pulse Metering (PPM) pulses should be collected from the public network to determine call cost. If this field is **y**, `Frequency` displays.
- **PPS** — Enter either **10** or **20** to specify the PPS (pulses per second) assigned to rotary dial pulse trunk groups. Valid entries are **10** (default) or **20**.



**NOTE:**

The TN439, TN458, TN497, TN747Bv12 (or later), and TN767 circuit packs can do only 10pps.

- **Programmed Dial Pause (msec)** — Enter the length (in msec) of a pause during abbreviated dialing, ARS outpulsing, and terminal dialing operations. This timer is administrable for all outgoing and two-way trunk groups. Valid entries are **100** to **25500** in increments of 100. Default is **1500**. This timer is sent to the TN464B (or later), TN760Dv15 (or later), TN767, TN458, and TN2140 tie circuit packs. All CO circuit packs that accept administrable timers accept this timer.
- **Release Ack Send (msec)** — Enter the duration (in msec) of the forward release acknowledgment signal. After receiving a forward release signal, the called switch must send the forward release acknowledgment signal. This signal is sent by grounding the M-lead for the duration specified by this timer. This field appears only if `Trunk Signaling Type` is **dis** and the trunk group `Direction` is **incoming** or **two-way**. Valid entries are **500** to **1200** in increments of 100. Default is **600**. Only TN2140 ports receive this timer.
- **Ringling Monitor (msec)** — Enter the minimum time required to determine if the trunk disconnects. If the ringing signal disappears for a duration longer than the time specified in this field, the call will be assumed to be disconnected. Valid entries are **200** to **51000** in increments of 200. The field cannot be blank; default is **5200**. This timer is sent to TN464C (or later), TN767, TN438 (all), TN447, TN465 (all), TN2138, TN2147, TN2184, and TN2199 CO circuit packs.
- **Seize Ack Delay (msec)** — Enter the maximum time (in msec) between receiving a seizure and the sending of seizure acknowledgment by the called switch. This field appears only if `Trunk Signaling Type` is **dis** and the trunk group `Direction` is **incoming** or **two-way**. Valid entries are **40** to **120** in increments of 10. Default is **100**. Only TN2140 ports receive this timer.

- **Seize Ack Send (msec)** — Enter the duration (in msec) of the seize acknowledge pulse. This field appears only if `Trunk Signaling Type` is **dis** and the trunk group `Direction` is **incoming** or **two-way**. Valid entries are **10** to **990** in increments of 10. Default is **80**. Only TN2140 ports receive this timer.
- **Tone (msec)** — Enter the length of a DTMF tone sent in response to a button depression at a hybrid station set. Valid entries are **20–2550** in increments of 10; the default is **350**. This field appears only if `Trunk Signaling Type` is blank. This timer is sent only to the TN2184 circuit boards. All CO, DIOD, and Tie circuit packs that accept administrable timers accept this timer. However, this timer is only sent to the following DID circuit packs: TN464B (or later), TN767, TN436B, TN459B, TN2146, TN2199, and TN429 and TN2184 ports in a DID trunk group.

## ATMS Thresholds form

### NOTE:

This form appears when `Direction` on Page 1 is **outgoing** or **two-way** and `ATMS` is enabled on the Feature-Related System Parameters form.

- **Allow ATMS Busyout, Error Logging and Alarming** — Enter **y** to allow ATMS error logging and alarming (subject to filtering depending on the service organization used to deal with alarms); default is **n**.
- **Far-End Test No.** — Enter the access number (1 to 20 digits) dialed to reach the TTL.
- **Marginal and Unacceptable Thresholds**
  - **Marginal Threshold - Max - 1004 Hz Loss** — Enter the maximum signal loss (**0** to **21**) for a 1004 Hz test tone (in dB) allowed before reporting a trunk as out of tolerance; default is **21**. A smaller dB value is more restrictive.
  - **Marginal Threshold - Min - 1004 Hz Loss** — Enter **-2** (default), **-1**, or **0** to **21** to indicate the minimum signal loss for a 1004 Hz test tone (in dB) allowed before reporting a trunk as out of tolerance. A larger dB value is more restrictive.
  - **Unacceptable Threshold - Max - 1004 Hz Loss** — Enter the maximum signal loss (**0** to **21**) for a 1004 Hz test tone (in dB) allowed before reporting a trunk as unacceptable; default is **21**. A smaller dB value is more restrictive.
  - **Unacceptable Threshold - Min - 1004 Hz Loss** — Enter **-2** (default), **-1**, or **0** to **21** to indicate the minimum signal loss for a 1004 Hz test tone (in dB) allowed before reporting a trunk as unacceptable. A larger dB value is more restrictive.

- **Marginal Threshold - -Dev - 404 Hz Loss** — Enter the maximum negative deviation of measured loss (**0 to 9**) at 404 Hz from the 1004 Hz test tone noise level (in dB) allowed before reporting a trunk as out of tolerance; default is **9**. Smaller dB values are more restrictive.
- **Marginal Threshold - +Dev - 404 Hz Loss** — Enter the maximum positive deviation of measured loss (**0 to 9**) at 404 Hz from the 1004 Hz test tone loss level (in dB) allowed before reporting a trunk as out of tolerance; default is **9**. Smaller dB values are more restrictive.
- **Unacceptable Threshold - -Dev - 404 Hz** — Enter the maximum negative deviation of measured loss (**0 to 9**) at 404 Hz from the 1004 Hz test tone loss level (in dB) allowed before reporting a trunk as unacceptable; default is **9**. Smaller dB values are more restrictive.
- **Unacceptable Threshold - +Dev - 404 Hz** — Enter the maximum positive deviation of measured loss (**0 to 9**) at 404 Hz from the 1004 Hz test tone loss level (in dB) allowed before reporting a trunk as unacceptable; default is **9**. Smaller dB values are more restrictive.
- **Marginal Threshold - -Dev - 2804 Hz** — Enter the maximum negative deviation of measured loss (**0 to 9**) at 2804 Hz from the 1004 Hz test tone loss level (in dB) allowed before reporting a trunk as out of tolerance; default is **9**. Smaller dB values are more restrictive.
- **Marginal Threshold - +Dev - 2804 Hz** — Enter the maximum positive deviation of measured loss (**0 to 9**) at 2804 Hz from the 1004 Hz test tone loss level (in dB) allowed before reporting a trunk as out of tolerance; default is **9**. Smaller dB values are more restrictive.
- **Unacceptable Threshold - -Dev - 2804 Hz** — Enter the maximum negative deviation of measured loss (**0 to 9**) at 2804 Hz from the 1004 Hz test tone loss level (in dB) allowed before reporting a trunk as unacceptable; default is **9**. Smaller dB values are more restrictive.
- **Unacceptable Threshold - +Dev - 2804 Hz** — Enter the maximum positive deviation of measured loss (**0 to 9**) at 2804 Hz from the 1004 Hz test tone loss level (in dB) allowed before reporting a trunk as unacceptable; default is **9**. Smaller dB values are more restrictive.
- **Marginal Threshold - Maximum C Message Noise** — Enter the maximum C-message noise interference (**15 to 55**) in dBmC above reference noise terminating on a voice terminal as measured within the voice band frequency range (500 to 2500 Hz) allowed before reporting a trunk as out of tolerance. The default is **55**. Smaller values are more restrictive.

- **Unacceptable Threshold - Maximum C Message Noise** — Enter the maximum C-message noise interference (**15 to 55**) in dBmC above reference noise terminating on a voice terminal as measured within the voice band frequency range (500 to 2500 Hz) allowed before reporting a trunk as unacceptable. The default is **55**. Smaller values are more restrictive.
- **Marginal Threshold - Maximum C Notched Noise** — Enter the maximum C-notched signal dependent noise interference (**34 to 74**) in dBmC allowed before reporting a trunk as out of tolerance. The default is **74**. Smaller values are more restrictive.
- **Unacceptable Threshold - Maximum C Notched Noise** — Enter the maximum C-notched signal dependent noise interference (**34 to 74**) in dBmC allowed before reporting a trunk as unacceptable. The default is **74**. Smaller values are more restrictive.
- **Marginal Threshold - Minimum SRL-HI** — Enter the minimum high-frequency signaling return loss (**0 to 40**) in dB allowed before reporting a trunk as out of tolerance. The default is **0**. Larger values are more restrictive.
- **Unacceptable Threshold - Minimum SRL-HI** — Enter the minimum high-frequency signaling return loss (**0 to 40**) in dB allowed before reporting a trunk as unacceptable. The default is **0**. Larger values are more restrictive.
- **Marginal Threshold - Minimum SRL-LO** — Enter the minimum low-frequency signaling return loss (**0 to 40**) in dB allowed before reporting a trunk as out of tolerance. The default is **0**. Larger values are more restrictive.
- **Unacceptable Threshold - Minimum SRL-LO** — Enter the minimum low-frequency signaling return loss (**0 to 40**) in dB allowed before reporting a trunk as unacceptable. The default is **0**. Larger values are more restrictive.
- **Marginal Threshold - Minimum ERL** — Enter the minimum low-frequency echo return loss (**0 to 40**) in dB allowed before reporting a trunk as out of tolerance. The default is **0**. Larger values are more restrictive.
- **Unacceptable Threshold - Minimum ERL** — Enter the minimum low-frequency echo return loss (**0 to 40**) in dB allowed before reporting a trunk as unacceptable. The default is **0**. Larger values are more restrictive.
- **Maximum Percentage of Trunks Which Can Be Removed From Service by ATMS** — Enter the highest percentage of trunks from the trunk group (**0 to 100**) that can be removed from service at one time because of unacceptable transmission measurement results; default is **0**.

- **Trunk Contact** — Enter up to 25 alphanumeric character name and/or number of the trunk vendor contact (the name and/or telephone number of someone from the trunk vendor who can be contacted in the event of problems with the trunks); default is blank.
- **Trunk Length** — Enter 0–4 digits followed by **k** (for kilometers) or **m** (for miles) showing the length of the trunk. This field is not required. It can be used to assist with threshold establishment, since noise on a trunk increases with the length of the trunk. The default is **0m**.
- **Trunk Vendor** — Enter up to 22 alphanumeric character name of the trunk vendor name (who to notify in the event of problems with the trunks); default is blank.
- **TTL Contact** — Enter the 0 to 25 alphanumeric character TTL vendor contact (the name and/or telephone number of someone from the TTL vendor who can be contacted in the event of problems with the TTL); default is blank.
- **TTL Type** — Specifies the type of TTL selected for testing trunks. The TTL type determines what ATMS tests can be completed and thus which threshold values need to be administered. The different TTLs supported are 105 with return loss (**105-w-rl**) (default), 105 without return loss (**105-wo-rl**), high-level tone source (**high-lts**), low-level tone source (**low-lts**), 100 type (**100**), and 102 type (**102**).

The following table explains the differences between TTL Types:

| Type TTL               | Description   | Example   |
|------------------------|---|---|
| <i>105-w-rl</i>        | Full range of 18 measurements or some defaults for return loss used (56A) | TN771B, ZLC12 and SN261B circuit packs and new 56A mini-responder |
| <i>105-wo-rl</i>       | Cannot return default values for far-end return loss                      | Older 56A mini-responder  |
| <i>high-level-tone</i> | Sends a fixed sequence of tones at 0 dBm                                  | ZLC12 and SN261B circuit packs                                    |
| <i>low-level-tone</i>  | Sends a fixed sequence of tones at -16dBm                                 | SN261B circuit pack   |
| <i>100</i>             | Up to 5 measurements that sends a 1004 Hz tone then a quiet termination   |   |
| <i>102</i>             | One measurement that sends a 1004 Hz tone                                 |   |

The far-end switch containing the TTL may be any of the following:



- System 85 R2 switch, equipped with the Maintenance/Test Board (TN771B)
- System 75 R1V2 and beyond, all of which contain the circuitry required to perform the TTL function
- System 85 R2 switch, equipped with the Analog/Digital Facility Test Circuit (ADFTC, SN261)
- DIMENSION FP8, equipped with the Analog Facility Test Circuit (AFTC, ZLC-12)
- Central Office switches, equipped with various TTL equipment that provide 100, 102, or 105 test line capabilities (56A)

Other vendor switches *may* be supported if compatible test lines are provided by these switches.

Four different versions of the ATMS Threshold Administration page can occur depending upon the measurements allowed by the TTL type selected. The four possibilities are:

1. 105-w-rl and 105-wo-rl — All thresholds appear.
  2. high-lts and low-lts — All thresholds (except maximum C-notched noise) appear.
  3. 100 — All thresholds (except maximum c-notched noise, 404Hz loss, and 2804 Hz loss) appear.
  4. 102 — Only 1004 Hz loss threshold appears.
- **TTL Vendor** — Enter the 0 to 22 alphanumeric character TTL vendor name (the name of the vendor supplying the terminating test line); default is blank.
  - **Unacceptable Thresholds** — See Marginal and Unacceptable Thresholds on page [7-143](#).

## Group Member Assignments form

### NOTE:

The total number of pages, and the first page of the Group Member Assignments, vary depending on whether the Administrable Timers and ATMS Thresholds pages display.

- **Administered Members (min/max)** — Indicates the minimum and maximum member numbers that have been administered for the particular trunk group. This field displays on all member pages.

- **Ans Delay** — Specifies the length of the wait for answer supervision delay (in ms) for trunks using the TN722A or later, TN760 (B, C, or D), TN767, TN464 (any suffix), TN437, TN439, TN458, or TN2140 circuit packs. Valid entries are **20** to **5100** in increments of 20; default is blank and internally treated as a zero. This delay serves two purposes:
    - Used to ensure that the answer supervision signal is valid and not a secondary delay-dial or wink-start signal.
    - Used to bridge over momentary off-hook signals resulting from connections made off-network through certain No. 5 Crossbar CCSA switches as the connection is being established.
  - **Code** — Display-only field. Displays the type of circuit pack physically installed or logically administered at the location to which this member has been assigned. If a circuit pack is neither installed nor administered at the member's location, the field is blank.
  - **Mode** — Specifies the signaling mode used on Tie Trunks with TN722A or later release, TN760B or later release, TN767, TN464 (any suffix), TN437, TN439, TN458, or TN2140 circuit packs. Valid entries are **e&m** (interface), **simplex** (phantomed), or **protected**. This entry must correspond to associated dip switch settings on the circuit pack.
  - **Name** — Enter up to ten characters to identify the member of the trunk group. The name can be a 7-digit telephone number or a 10-digit Trunk Circuit Identification number (provided by the trunk supplier).
  - **Night** — Enter the extension of the night destination for the trunk. This individual night destination overrides the group night service destination on the first page of the trunk group form. Incoming calls are routed to this destination when the system is placed in night service mode. (If **attd** is entered, night service will be to the attendant.)
  - **Port** — Enter seven characters. The first two characters identify the cabinet (01 to 44 [R6r], 01 to 03 [R6si]); the third character identifies the carrier (A through E); the fourth and fifth identify the slot number in the carrier (01 to 20 for multi-carrier cabinets or 01 to 18 for single-carrier cabinets); the last two characters identify the circuit number (01 to 31).
-  **NOTE:**  
When supporting DCS, it is required that the trunk be the same member number on both nodes. The member number of the trunk is the display-only field at the far left of the screen, just before the `Port` field.
- **Sfx** — (Display-only field) Displays the type of circuit pack (suffix only) physically installed at the location to which this member has been assigned. Field is blank if a circuit pack has not been physically installed.
  - **Total Administered Members** (Display-only field) — Indicates the total number of members administered in the trunk group. This field appears on all trunk group member pages.

- **Type** — Specifies the signaling type to be used. This field should be used only with TN760B (or later release), TN722 (with any suffix), TN767, TN2140 (when Trunk Signaling Type is **cont**), TN437, TN439, TN464 with any suffix, or TN458 circuit packs.

The Type column displays when Trunk Signaling Type is blank or **cont**. The Type column does not display if Trunk Signaling Type is **dis**.

The value of **t5 rev** is allowed only for the TN760D vintage 10 or later. When Type is **t5 rev**, Mode must be **e&m**.

Valid entries are **t1 stan**, **t1 comp**, **t5rev**, or **type 5**. Default is blank.

## Access trunk group

---

This form provides the ability to communicate with another switch as either a main or tandem switch in an Electronic Tandem Network (ETN). However, this trunk group does not send or receive Traveling Class Marks.

An ISDN trunk group whose `Service Type` is **access** can also function as an access trunk group.

### Administration commands

---

Use the following commands to administer the Access trunk group form.

| Action  | Object      | Qualifier <sup>1</sup>  |
|---------|-------------|---|
| add     | trunk-group | 1-MAX (or 'next')   |
| change  | trunk-group | 1-MAX or TAC X...   |
| display | trunk-group | 1-MAX ['number' X]['to-number' X]['count' N]<br>['tac' assigned TAC]['print' or 'schedule'] |
| list    | trunk-group | ['print' or 'schedule']   |
| remove  | trunk-group | 1-MAX or TAC X...   |

1. Brackets [ ] indicate the qualifier is optional. Single quotes ( ' ' ) indicate the text inside the quote must be entered exactly as shown or an abbreviated form of the word may be entered. MAX is the maximum number available in your system configuration.

### Hardware requirements

---

A port is required on a TN464D, TN722B, TN760C, or TN767 circuit pack for each trunk assigned in the Access trunk group. A TN464D provides 24 or 32 ports, a TN722B or TN767 provides 24 ports, and a TN760C provides 4 ports.

### Field descriptions

---

The fields on the following forms are described in [“Trunk Groups — General” on page 7-115](#).

## Access trunk group form page 1

Page 1 of X

TRUNK GROUP

|                            |                     |                            |
|----------------------------|---------------------|----------------------------|
| Group Number: xxx          | Group Type: access  | CDR Reports: y             |
| Group Name: Did - Incoming | DTMF ANI            | COR: 1_                    |
| Direction: two-way_        | Outgoing Display? n | TN: 1__ TAC: ____          |
| Dial Access? n             | Busy Threshold: 99_ | Trunk Signaling Type: ____ |
| Queue Length: 0__          |                     | Night Service: ____        |
| Comm Type: voice           | Auth Code? n        | Incoming Destination: ____ |

TRUNK PARAMETERS

|                               |                                  |
|-------------------------------|----------------------------------|
| Trunk Type (in/out): _____    | Incoming Rotary Timeout(sec): 5_ |
| Outgoing Dial Type: tone_____ | Incoming Dial Type: tone_____    |
|                               | Disconnect Timing(msec): 500_    |
| Digit Treatment: _____        | Digits: ____                     |
|                               | Sig Bit Inversion: none          |
| Terminal Balanced? n          | RA Trunk Loss: 0db               |
| Incoming Dial Tone? y         |                                  |

|                                       |                               |
|---------------------------------------|-------------------------------|
| Disconnect Supervision - In? y Out? n |                               |
| Answer Supervision Timeout: 0__       | Receive Answer Supervision? y |

Screen 7-17. Access Trunk Group form (page 1)



## Access trunk group form page 2

```
change trunk-group 1                                     Page 2 of X
TRUNK FEATURES
  ACA Assignment? n                                     Measured: none
                                                    Maintenance Tests? y
                Data Restriction? n
  Used for DCS? n
  Suppress # Outpulsing? n
    Seize When Maintenance Busy: _____
  Incoming Tone (DTMF) ANI? y                         Per Call CPN Blocking Code: ___
                                                    Per Call CPN Unblocking Code: ___
```

Screen 7-19. Access Trunk Group form (page 2)

### Implementation notes

---

In Incoming Tone (DTMF) ANI, enter **y** to activate the Inband ANI/DNIS feature. Default is **n**.

### Administrable Timers form

```
                                                    TRUNK GROUP
                                                    Page Y of X
ADMINISTRABLE TIMERS
  Incoming Disconnect(msec): 500                    Outgoing Disconnect(msec): 500
  Incoming Dial Guard(msec): 70                     Outgoing Dial Guard(msec): 1600
  Incoming Glare Guard(msec): 1500                  Outgoing Glare Guard(msec): 1500
  Incoming Partial Dial(sec): 18
  Outgoing End of Dial(sec): 10                      Outgoing Rotary Dial Interdigit(msec): 800_
  Programmed Dial Pause(msec): 1500                  Outgoing Seizure Response(sec): 5
                                                    Disconnect Signal Error(sec): 240
                                                    Incoming Incomplete Dial Alarm(sec): 255
END TO END SIGNALING
  Tone (msec): 350                                  Pause (msec): 150
OUTPULSING TIMING
  PPS: 10      Make (msec): 40                      Break (msec): 60
```

Screen 7-20. Access Trunk Group Administrable Timers form

## Implementation notes

Outgoing End of Dial displays if Receive Answer Supervision from Page 1 is **n**.

Incoming Dial Guard is administrable when Trunk Signaling Type is blank.

Outgoing Disconnect displays if Trunk Signaling Type is **blank or cont** and Direction is **outgoing or two-way**.

## ATMS Thresholds form

Page Y of X

ATMS THRESHOLDS

TTL Type: 105-w-rl \_\_\_\_\_ Far End Test No: \_\_\_\_\_  
TTL Vendor: \_\_\_\_\_ TTL Contact: \_\_\_\_\_  
Trunk Vendor: \_\_\_\_\_ Trunk Contact: \_\_\_\_\_  
Trunk Length: \_\_\_\_\_

|                          | MARGINAL |      | UNACCEPTABLE |      |
|--------------------------|----------|------|--------------|------|
|                          | Min      | Max  | Min          | Max  |
| 1004 Hz Loss:            | -2       | 21   | -2           | 21   |
|                          | -Dev     | +Dev | -Dev         | +Dev |
| 404 Hz Loss:             | 9        | 9    | 9            | 9    |
| 2804 Hz Loss:            | 9        | 9    | 9            | 9    |
| Maximum C Message Noise: |          | 55   |              | 55   |
| Maximum C Notched Noise: |          | 74   |              | 74   |
| Minimum SRL-HI:          |          | 0_   |              | 0_   |
| Minimum SRL-LO:          |          | 0_   |              | 0_   |
| Minimum ERL:             |          | 0_   |              | 0_   |

Allow ATMS Busyout, Error Logging and Alarming? y  
Maximum Percentage of Trunks Which Can Be Removed from Service by ATMS: 0\_

### Screen 7-21. Access Trunk Group ATMS Thresholds form



### Group Member Assignments form

| GROUP MEMBER ASSIGNMENTS |       | TRUNK GROUP |       |       |       | Page Y of X |       |       |  |
|--------------------------|-------|-------------|-------|-------|-------|-------------|-------|-------|--|
| Port                     | Code  | Sfx         | Name  | Night | Mode  | Type        | Ans   | Delay |  |
| 1:                       | _____ | _____       | _____ | _____ | _____ | _____       | _____ | _____ |  |
| 2:                       | _____ | _____       | _____ | _____ | _____ | _____       | _____ | _____ |  |
| 3:                       | _____ | _____       | _____ | _____ | _____ | _____       | _____ | _____ |  |
| 4:                       | _____ | _____       | _____ | _____ | _____ | _____       | _____ | _____ |  |
| 5:                       | _____ | _____       | _____ | _____ | _____ | _____       | _____ | _____ |  |
| 6:                       | _____ | _____       | _____ | _____ | _____ | _____       | _____ | _____ |  |
| 7:                       | _____ | _____       | _____ | _____ | _____ | _____       | _____ | _____ |  |
| 8:                       | _____ | _____       | _____ | _____ | _____ | _____       | _____ | _____ |  |
| 9:                       | _____ | _____       | _____ | _____ | _____ | _____       | _____ | _____ |  |
| 10:                      | _____ | _____       | _____ | _____ | _____ | _____       | _____ | _____ |  |
| 11:                      | _____ | _____       | _____ | _____ | _____ | _____       | _____ | _____ |  |
| 12:                      | _____ | _____       | _____ | _____ | _____ | _____       | _____ | _____ |  |
| 13:                      | _____ | _____       | _____ | _____ | _____ | _____       | _____ | _____ |  |
| 14:                      | _____ | _____       | _____ | _____ | _____ | _____       | _____ | _____ |  |
| 15:                      | _____ | _____       | _____ | _____ | _____ | _____       | _____ | _____ |  |

Screen 7-22. Access Group Member Assignments form

## APLT trunk group

---

This form provides access to and termination from advanced private line termination (APLT) networks. APLT trunks are used with a Common Control Switching Arrangement (CCSA) or Enhanced Private Switched Communications Service (EPSCS) network. If the trunk group is assigned as external, incoming calls have a 2-burst distinctive-ringing signal.

### ⇒ NOTE:

On the Class of Restriction form, you must enter **n** in APLT to allow access to APLT trunk group CCSA and EPSCS networks.

## Administration commands

---

Use the following commands to administer the APLT trunk group form.

| Action  | Object      | Qualifier <sup>1</sup>  |
|---------|-------------|---|
| add     | trunk-group | 1-MAX (or 'next')   |
| change  | trunk-group | 1-MAX or TAC X...   |
| display | trunk-group | 1-MAX ['number' X][ 'to-number' X][ 'count' N]<br>[ 'tac' assigned TAC][ 'print' or 'schedule'] |
| list    | trunk-group | [ 'print' or 'schedule']  |
| remove  | trunk-group | 1-MAX or TAC X...   |

1. Brackets [ ] indicate the qualifier is optional. Single quotes ( ' ') indicate the text inside the quote must be entered exactly as shown or an abbreviated form of the word may be entered. MAX is the maximum number available in your system configuration.

## Hardware requirements

---

A port on a TN760C circuit pack or TN464D, TN722B, or TN767 DS1 circuit pack is required for each trunk assigned in the APLT trunk group. A TN760C provides 4 ports for 4-wire E&M lead signaling. A TN722B or TN767 provides 24 ports, and the TN464D provides either 24 or 32 ports, for Tie trunk groups, RLT groups, and APLT trunk groups.

## Field descriptions

---

The fields on the following forms are described in ["Trunk Groups — General"](#).

## APLT trunk group form page 1

|                                       |                               |                            |
|---------------------------------------|-------------------------------|----------------------------|
| TRUNK GROUP                           |                               | Page 1 of X                |
| Group Number: 1                       | Group Type: aplt              | CDR Reports: y             |
| Group Name: Did - Incoming            | DTMF ANI COR: 1               | TN: 1__ TAC: ____          |
| Direction: two-way                    | Outgoing Display? n           | Trunk Signaling Type: ____ |
| Dial Access? y                        | Busy Threshold: 99            | Night Service: ____        |
| Queue Length: 0                       | Incoming Destination: ____    |                            |
|                                       | Auth Code? n                  |                            |
| TRUNK PARAMETERS                      |                               |                            |
| Trunk Type(in/out): ____              | Incoming Rotary Timeout: 5    |                            |
| Outgoing Dial Type: tone              | Incoming Dial Type: tone      |                            |
|                                       | Disconnect Timing(msec): 500  |                            |
|                                       | Digits:                       |                            |
| Terminal Balanced? n                  | Sig Bit Inversion: none       |                            |
| Incoming Dial Tone? y                 | RA Trunk Loss: 0db            |                            |
| Disconnect Supervision - In? y Out? n |                               |                            |
| Answer Supervision Timeout: 0         | Receive Answer Supervision? y |                            |

### Screen 7-23. APLT Trunk Group form (page 1)

#### Implementation notes

---

Answer Supervision Timeout defaults to **0**.

BCC displays when Comm Type is **avd** or when ISDN-PRI or ISDN-BRI Trunks is optioned on the System-Parameters Customer-Options form and Comm Type is **avd**, **data**, or **rbavd**.

Queue Length displays when Direction is **outgoing** or **two-way**.

Night Service displays when Direction is **incoming** or **two-way**.

Synchronization displays when Comm Type is **avd** or **rbavd**.

## APLT trunk group form page 2

```
change trunk-group 1                                     Page 2 of X

                                     TRUNK GROUP

TRUNK FEATURES
  ACA Assignment? n          Measured: none
                                     Maintenance Tests? y
                                     Data Restriction? n

Suppress # Outpulsing? n
  Seize When Maintenance Busy: _____

Incoming Tone (DTMF) ANI? y          Per Call CPN Blocking Code: ____
                                     Per Call CPN Unblocking Code: ____
```

Screen 7-24. APLT Trunk Group form (Page 2)

### Implementation notes

In Incoming Tone (DTMF) ANI, enter **y** to activate the Inband ANI/DNIS feature. Default is **n**.

### Administrable Timers form

```
                                     TRUNK GROUP                                     Page Y of X

ADMINISTRABLE TIMERS
  Incoming Disconnect(msec): 500          Outgoing Disconnect(msec): 500
  Incoming Dial Guard(msec): 70          Outgoing Dial Guard(msec): 1600
  Incoming Glare Guard(msec): 1500       Outgoing Glare Guard(msec): 1500

                                     Outgoing Rotary Dial Interdigit(msec): 800_
  Outgoing End of Dial(sec): 10          Outgoing Seizure Response(sec): 5
  Programmed Dial Pause(msec): 1500     Disconnect Signal Error(sec): 240
                                     Incoming Incomplete Dial Alarm(sec): 255

END TO END SIGNALING
  Tone (msec): 350          Pause (msec): 150

OUTPULSING TIMING
  PPS: 10          Make (msec): 40          Break (msec): 60
```

Screen 7-25. APLT Trunk Group Administrable Timers form

## Implementation notes

Incoming Dial Guard is administrable when Trunk Signaling Type is blank.

Outgoing Disconnect displays if Trunk Signaling Type is **blank** or **cont** and Direction is **outgoing** or **two-way**.

## ATMS Thresholds form

| ATMS THRESHOLDS  |          |      |              |      |                        | Page Y of X |
|--|----------|------|--------------|------|------------------------|-------------|
| TTL Type: 105-w-rl_____  |          |      |              |      | Far End Test No: _____ |             |
| TTL Vendor: _____  |          |      |              |      | TTL Contact: _____     |             |
| Trunk Vendor: _____  |          |      |              |      | Trunk Contact: _____   |             |
| Trunk Length: _____  |          |      |              |      |                        |             |
|  | MARGINAL |      | UNACCEPTABLE |      |                        |             |
|  | Min      | Max  | Min          | Max  |                        |             |
| 1004 Hz Loss:  | -2       | 21   | -2           | 21   |                        |             |
|  | -Dev     | +Dev | -Dev         | +Dev |                        |             |
| 404 Hz Loss:   | 9        | 9    | 9            | 9    |                        |             |
| 2804 Hz Loss:  | 9        | 9    | 9            | 9    |                        |             |
| Maximum C Message Noise:   | 55       |      | 55           |      |                        |             |
| Maximum C Notched Noise:   | 74       |      | 74           |      |                        |             |
| Minimum SRL-HI:  | 0_       |      | 0_           |      |                        |             |
| Minimum SRL-LO:  | 0_       |      | 0_           |      |                        |             |
| Minimum ERL:   | 0_       |      | 0_           |      |                        |             |
| Allow ATMS Busyout, Error Logging and Alarming? y                          |          |      |              |      |                        |             |
| Maximum Percentage of Trunks Which Can Be Removed from Service by ATMS: 0_ |          |      |              |      |                        |             |

Screen 7-26. APLT Trunk Group ATMS Thresholds form

### Group Member Assignments form

| TRUNK GROUP                            |       |       |     |       |       |       |       |           |
|--|-------|-------|-----|-------|-------|-------|-------|-----------|
| Page Y of X                            |       |       |     |       |       |       |       |           |
| Administered Members(min/max): xxx/yyy |       |       |     |       |       |       |       |           |
| Total Administered Members: xxx        |       |       |     |       |       |       |       |           |
| GROUP MEMBER ASSIGNMENTS               |       |       |     |       |       |       |       |           |
|  | Port  | Code  | Sfx | Name  | Night | Mode  | Type  | Ans Delay |
| 1:                                     | _____ | _____ | -   | _____ | _____ | _____ | _____ | _____     |
| 2:                                     | _____ | _____ | -   | _____ | _____ | _____ | _____ | _____     |
| 3:                                     | _____ | _____ | -   | _____ | _____ | _____ | _____ | _____     |
| 4:                                     | _____ | _____ | -   | _____ | _____ | _____ | _____ | _____     |
| 5:                                     | _____ | _____ | -   | _____ | _____ | _____ | _____ | _____     |
| 6:                                     | _____ | _____ | -   | _____ | _____ | _____ | _____ | _____     |
| 7:                                     | _____ | _____ | -   | _____ | _____ | _____ | _____ | _____     |
| 8:                                     | _____ | _____ | -   | _____ | _____ | _____ | _____ | _____     |
| 9:                                     | _____ | _____ | -   | _____ | _____ | _____ | _____ | _____     |
| 10:                                    | _____ | _____ | -   | _____ | _____ | _____ | _____ | _____     |
| 11:                                    | _____ | _____ | -   | _____ | _____ | _____ | _____ | _____     |
| 12:                                    | _____ | _____ | -   | _____ | _____ | _____ | _____ | _____     |
| 13:                                    | _____ | _____ | -   | _____ | _____ | _____ | _____ | _____     |
| 14:                                    | _____ | _____ | -   | _____ | _____ | _____ | _____ | _____     |
| 15:                                    | _____ | _____ | -   | _____ | _____ | _____ | _____ | _____     |

Screen 7-27. APLT Group Member Assignments form

## CAMA - E911 trunk group

---

This form administers the Centralized Automatic Message Accounting (CAMA) trunks and provides Caller's Emergency Service Identification (CESID) information to the local community's Enhanced 911 system through the local Tandem Office.

When the CAMA feature is administered and a 911 call is placed from a DEFINITY ECS station, DEFINITY software searches for the proper CAMA Touch-Tone Receiver (TTR) resource in the port network (PN) where the CAMA trunk group is located.

If the proper CAMA TTR resource is not available in that PN, the software checks any other available PNs for the proper CAMA TTR resource. If this resource is not found in the entire system, a busy tone is returned to the calling party. However, if another trunk group is in the same routing pattern as the CAMA trunk group, the call routes to the next available trunk group in the pattern. For example, if a CO trunk group is used, then any available TTR resource can be used and the call routes as a normal call over the CO trunk and the public switched telephone network (PSTN).

### Administration commands

---

The ability to change and display CAMA numbering is restricted to Administrators with add/change permission.

Use the following commands to administer the CAMA - E911 trunk group form.

| Action  | Object      | Qualifier <sup>1</sup>  |
|---------|-------------|---|
| add     | trunk-group | 1-MAX (or 'next')   |
| change  | trunk-group | 1-MAX or TAC X...   |
| display | trunk-group | 1-MAX ['number' X]['to-number' X]['count' N]<br>['tac' assigned TAC]['print' or 'schedule'] |
| list    | trunk-group | ['print' or 'schedule']   |
| remove  | trunk-group | 1-MAX or TAC X...   |

1. Brackets [ ] indicate the qualifier is optional. Single quotes ( ' ' ) indicate the text inside the quote must be entered exactly as shown or an abbreviated form of the word may be entered. MAX is the maximum number available in your system configuration.

## Hardware requirements

---

- TN429C CO circuit pack

### NOTE:

CAMA requires at least one of the following two circuit packs in the port network's supporting CAMA trunk groups.

- TN2182BV1 or TN2182BV2 Tone Clock/Call Classifier - Detector circuit pack or later configuration.
- TN744DV1 or TN744DV2 Call Classifier - Detector circuit pack or later configuration.

The following touch-tone receivers (TTRs) are not compatible:

- TN748 any vintage
- TN756

Lucent recommends all TTR-equipped circuit packs in the PN with CAMA trunk groups be either TN2182BV1/TN2182BV2 or TN744DV1/TN744DV2 or later configurations.

## How to administer CAMA - E911 trunk groups

---

### Required forms

| Form                     | Field                                    | Page |
|--------------------------|--|------|
| ARS Digit Analysis Table | ■ All                                    |      |
| CAMA Numbering Format    | ■ All                                    |      |
| Class of Restriction     | ■ Calling Party Restriction              |      |
| Feature Access Code      | ■ ARS Access Code1<br>■ ARS Access Code2 |      |
| Route Pattern            | ■ All                                    |      |
| Trunk Group (CAMA)       | ■ All                                    |      |

- Trunk Group (CAMA) — Complete all fields as required.
  - **Group Type** — Enter **cama**.



## Field Descriptions

---

Many of the fields on the following forms are described in [“Trunk Groups — General”](#). If a field on this form is unique, it is listed and defined in the following paragraphs.

## Form instructions

---

Make assignments as required for the following fields on the form.

### Page 1 of the form

```
Page 1 of 10

TRUNK GROUP

Group Number: xxx          Group Type: cama          CDR Reports: y
Group Name: Emergency 911  COR: 1          TN: 1          TAC: 602
Direction: outgoing       Outgoing Display? y    CESID I Digits Sent: 0
                          Busy Threshold: 99

TRUNK PARAMETERS
  Trunk Type: wink-start
  Outgoing Dial Type: rlmf
  Trunk Termination: rc
                          Trunk Gain: high
```

### Screen 7-28. CAMA Trunk Group form

## Fields unique to this form

---

The following fields are unique to the CAMA - E911 trunk group form:

- **CESID I Digits Sent** — The CESID Information (I) digits sent by the PBX to tell the Central Office or E911 tandem switch how to interpret the received ANI or CESID digits and is part of the E911 signaling protocol. Valid entries are from 1 to 3 digits, or leave blank (default).
- **Outgoing Dial Type** — Enter **r1mf** (default).

## Trunk Features form

Page 2 of 10

TRUNK FEATURES

ACA Assignment? n

Maintenance Tests? y

### Screen 7-29. Trunk Features form

## Administrable Timers form

Page 3 of 10

TRUNK GROUP

ADMINISTRABLE TIMERS

Outgoing Disconnect (msec): 400  
Cama Outgoing Dial Guard (msec): 75  
Outgoing Glare Guard (msec): 1000

Outgoing End of Dial (sec): 1      Cama Wink Start Time (msec): 5000  
Outgoing Seizure Response (sec): 4  
Disconnect Signal Error (sec): 30

### Screen 7-30. Administrable Timers form

## Implementation notes

---

- **Outgoing Disconnect (msec)** — Used to disconnect signal for an outgoing trunk call. It begins when the disconnect signal is detected and reset when the signal is no longer detected. The disconnect signal is considered valid if it lasts at least for the time specified by this timer. The trunk is dropped when the timer is expired. Enter a number between **50** and **2550** in increments of 10 or enter **400** (default). Blank is not a valid entry.

- **Cama Outgoing Dial Guard (msec)** — Specifies the minimum time between seizure acknowledgment of a trunk and the outpulsing of digits. Enter a number between **25** and **6375** in increments of 25 or enter **75** (default). Blank is not a valid entry.
- **Outgoing Glare Guard (msec)** — Specifies the minimum time between release of a trunk after an outgoing call and seizure of the same trunk for an outgoing call. Enter a number between **100** and **25500** in increments of 100 or enter **1000** (default). Blank is not a valid entry.
- **Outgoing End of Dial (sec)** — Specifies how long the PBX has to wait before an answer supervision can be assumed for those CO trunks which do not provide call answer supervision. Enter a number between **1** and **254** in increments of 1 or enter **1** (default).
- **Outgoing Seizure Response (sec)** — Specifies the time by which the switch should receive the proceed to dial indication from the far end after sending the seize signal. If the indication is not received in this time, the seizure failure response message is uplinked. A different value is required for the Cama trunk type. Enter a number between **1** and **255** in increments of 1 or enter **4** (default).
- **Cama Wink Start Time (msec)** — Specifies the wait-for-wink-to-end time for the wink start Cama trunk. The wink must begin within the value of the Outgoing Seizure Response timer. Enter a number between **20** and **5100** in increments of 20 or enter **5000** (default).
- **Disconnect Signal Error (sec)** — Specifies how long to wait for the far end to release a call after the PBX sends a disconnect signal, before logging error of lacking release from the far end. Enter a number between **1** and **255** in increments of 1 or enter **30** (default).

### Group Members Assignments form

Page 4 of 10

TRUNK GROUP

Administered Members (min/max): 1/2  
 Total Administered Members: 2

GROUP MEMBER ASSIGNMENTS

| Port | Code    | Sfx   | Name |
|------|---------|-------|------|
| 1:   | 01C0401 | TN429 | C    |
| 2:   | 01C0402 | TN429 | C    |
| 3:   |         |       |      |
| 4:   |         |       |      |
| 5:   |         |       |      |
| 6:   |         |       |      |
| 7:   |         |       |      |
| 8:   |         |       |      |
| 9:   |         |       |      |
| 10:  |         |       |      |
| 11:  |         |       |      |
| 12:  |         |       |      |
| 13:  |         |       |      |

Screen 7-31. Group Member Assignments form (page 4)

### List Trunk Groups form

Page 1 of 3

TRUNK GROUPS

| Grp No. | TAC | Out Que  | Group Name      | Mem | TN | COR | CDR | Meas | Disp | Len |
|---------|-----|----------|-----------------|-----|----|-----|-----|------|------|-----|
| 1       | 601 | isdn-pri | dcx pri dr3:dr6 | 8   | 1  | 1   | Y   | none | n    | 0   |
| 2       | 602 | cama     | emergency 911   | 2   | 1  | 1   | Y   | none | n    | 0   |
| 3       | 603 | tie      | dcx dsl dr3:dr6 | 4   | 1  | 1   | Y   | none | n    | 0   |
| 4       | 604 | tie      | dcx data        | 1   | 1  | 1   | Y   | none | n    | 0   |
| 5       | 88  | tie      | dr2/dsl-data    | 1   | 1  | 1   | Y   | none | n    | 0   |
| 6       | 86  | tie      | dr2/dsl-tie     | 4   | 1  | 1   | Y   | none | n    | 0   |
| 7       | 87  | tie      | dr22/dr3-dsl    | 4   | 1  | 1   | Y   | none | n    | 0   |
| 8       | 608 | isdn-pri | dr22/pri        | 4   | 1  | 1   | Y   | none | n    | 0   |
| 9       | 609 | tie      | DCS/dr22/data   | 1   | 1  | 1   | Y   | none | n    | 0   |
| 10      | 610 | isdn-pri | PRI/DR22        | 4   | 1  | 1   | Y   | none | n    | 0   |
| 11      | 611 | isdn-pri | PRI/dr06        | 9   | 1  | 1   | Y   | none | Y    | 0   |
| 12      | 612 | isdn-pri | DTGS-DCS        | 4   | 1  | 1   | Y   | none | n    | 0   |
| 13      | 613 | tie      | DTGS-DCS        | 4   | 1  | 1   | Y   | none | n    | 0   |
| 14      | 614 | tie      | DCS dr3:dr6 alg | 1   | 1  | 1   | Y   | none | n    | 0   |

Screen 7-32. List Trunk Groups form

### Interactions

- When an Expert Agent Selection (EAS) agent dials 911, the CESID outpulsed will be of the physical station, not the logical agent.

**7** Trunk Group Administration  
*CAMA - E911 trunk group*

*Page 7-167*

- CAMA/E911 will only work on DEFINITY ECS if TN429C and TN2182BV1/TN2182BV2 (or TN744DV1/TN744DV2) or later configuration TTR-equipped circuit packs are used. This feature will not always work properly if other circuit packs providing Touch-Tone Receiver (TTR) or General-Purpose Tone Receiver (GPTR) are in the same port network as the TN429C circuit packs used to interface with CAMA trunks.
- Lucent does not recommend the tandeming of 911 calls.
- 911 calls from a bridged extension will report the CESID of the principle station.
- The CAMA/E911 Interface feature is compatible with the Attendant Crisis Alert feature.
- The CAMA/E911 feature does not impact the functionality of the XTEND, Telident, and Proctor adjuncts.
- Class of Restriction (COR), Tenant Partitioning, and Facilities Restriction Level (FRL) restrictions apply to CAMA trunks and 911 calls.
- When a Personal Station Access/Terminal Translation Initialization (PAS/TTI) station is associated with a physical station, the CESID outpulsed when dialing 911 is that of the PSA/TTI station, not of the physical station.

## CO trunk group

---

This form connects the system to the public telecommunications network via a local central office (CO).

If the CO is a step-by-step office, complete the Digit Absorption form. Digit Absorption List on this form must reference the Digit Absorption List Number.

### Administration commands

---

Use the following commands to administer the CO trunk group form.

| Action  | Object      | Qualifier <sup>1</sup>  |
|---------|-------------|---|
| add     | trunk-group | 1-MAX (or 'next')   |
| change  | trunk-group | 1-MAX or TAC X...   |
| display | trunk-group | 1-MAX ['number' X][ 'to-number' X][ 'count' N]<br>[ 'tac' assigned TAC][ 'print' or 'schedule'] |
| list    | trunk-group | [ 'print' or 'schedule']  |
| remove  | trunk-group | 1-MAX or TAC X...   |

1. Brackets [ ] indicate the qualifier is optional. Single quotes ( ' ') indicate the text inside the quote must be entered exactly as shown or an abbreviated form of the word may be entered. MAX is the maximum number available in your system configuration.

### Hardware requirements

---

A port on an analog CO or digital DS1 circuit pack is required for each CO trunk assigned. For example, a TN747B provides 8 analog ports, a TN767 provides 24 digital ports, and a TN464D provides either 24 or 32 digital ports. Other circuit packs may also be used. See *System Description Pocket Reference* for the complete list of trunk circuit packs and their capabilities.

For Republic of China: This feature utilizes the TN2147C Analog CO Trunk circuit pack. Customers wishing to receive Periodic Pulse Metering (PPM) will continue to use the TN465C LS CO Trunk circuit pack because the TN21477C does not detect Chinese PPM.

## How to administer CO trunk groups

### Required forms

| Form                             | Field | Page                  |
|----------------------------------|-------|-----------------------|
| Trunk Group (CO)                 | ■ All | <a href="#">7-168</a> |
| Digit Absorption                 | ■ All | <a href="#">7-91</a>  |
| DS1 Circuit Pack                 | ■ All | <a href="#">7-79</a>  |
| ARS and ARS Digit Analysis Table | ■ All | <a href="#">8-54</a>  |

- Trunk Group (CO) — Complete all fields as required.
- Digit Absorption — If required, complete this form when the central office is a step-by-step office. `Digit Absorption List` on the Central Office trunk group form must reference the Digit Absorption List Number entered on the form.
- DS1 Circuit Pack form — Complete all fields as required if the DS1 circuit pack is used.
- ARS Analysis Table form — Complete all fields as required. The table controls the dialing patters that can be used with Central Office Trunk Groups.

### Interactions

For Republic of China: When `Country` is set to **18**, the TN2147C provides the same signaling characteristics of the TN465C including:

- Dual Tone Multi-frequency (DTMF) tone-on timing
- DTMF tone-off timing
- Signaling protocol

For Republic of China: When `Country` is set to **18**, the TN2147C provides the same transmission characteristics of the TN465C including:

- DTMF high frequency gain
- DTMF low frequency gain
- Ring detector impedace
- Transmission gain or loss





## CO trunk group form page 2

Page 2 of X

TRUNK FEATURES

ACA Assignment? n Measured: none

Maintenance Tests? y

Data Restriction? n

Abandoned Call Search? n

Suppress # Outpulsing? n

Shuttle? n

Charge Conversion: 1\_\_\_\_

Decimal Point: none\_\_

Currency Symbol: \_\_\_\_

Charge Type: units\_\_ Receive Analog Incoming Call ID: disabled

Per Call CPN Blocking Code: \_\_\_\_

Per Call CPN Unblocking Code: \_\_\_\_

### Screen 7-34. CO Trunk Group form (Page 2)

#### Implementation notes

---

Shuttle displays when Country Code is **15** and Outgoing Dial Type is **rotary**.

#### Administrable Timers form

Page Y of X

TRUNK GROUP

ADMINISTRABLE TIMERS

|                                   |  |
|-----------------------------------|--|
| Incoming Disconnect(msec): 500    | Outgoing Disconnect(msec): 500             |
|                                   | Outgoing Dial Guard(msec): 1600            |
| Incoming Glare Guard(msec): 1500  | Outgoing Glare Guard(msec): 1500           |
|                                   | Outgoing Rotary Dial Interdigit(msec): 800 |
| Ringing Monitor(msec): 5200       | Incoming Seizure(msec): 500                |
| Outgoing End of Dial(sec): 10     | Outgoing Seizure Response(sec): 5          |
| Programmed Dial Pause(msec): 1500 | Disconnect Signal Error(sec): 240          |
| Flash Length(msec): 540           |  |

END TO END SIGNALING

|                  |                   |
|------------------|-------------------|
| Tone (msec): 350 | Pause (msec): 150 |
|------------------|-------------------|

OUTPULSING INFORMATION

PPS: 10 Make(msec): 40 Break(msec): 60 PPM? y Frequency: 50/12k

### Screen 7-35. Administrable Timers for Ground Start CO Trunk Group (two-way) with PPM

## Implementation note

---

Outgoing Disconnect displays if Direction is **outgoing** or **two-way** and Trunk Type is **ground-start**.

Outgoing End of Dial does not display if Receive Answer Supervision is **y**.

Page Y of X

### TRUNK GROUP

#### ADMINISTRABLE TIMERS

|                                   |  |
|-----------------------------------|--|
| Incoming Disconnect(msec): 500    | Outgoing Disconnect(msec): 500             |
|                                   | Outgoing Dial Guard(msec): 1600            |
| Incoming Glare Guard(msec): 1500  | Outgoing Glare Guard(msec): 1500           |
|                                   | Outgoing Rotary Dial Interdigit(msec): 800 |
| Ringing Monitor(sec): 5200        | Incoming Seizure(msec): 500                |
| Outgoing End of Dial(sec): 10     | Outgoing Seizure Response(sec): 5          |
| Programmed Dial Pause(msec): 1500 |  |
| Flash Length(msec): 540           |  |

#### END TO END SIGNALING

|                  |                   |
|------------------|-------------------|
| Tone (msec): 350 | Pause (msec): 150 |
|------------------|-------------------|

#### OUTPULSING INFORMATION

PPS: 10    Make(msec): 40    Break(msec): 60    Analog PPM? y

### Screen 7-36. Administrable Timers for Loop Start CO Trunk Group (two-way)

## Implementation notes

---

Outgoing Disconnect displays if Direction is **outgoing** or **two-way** and Trunk Type is **loop-start**.

Outgoing Disconnect also displays if Direction is **outgoing** or **two-way**, Country Code is **15**, and Trunk Type is **2-wire-ac**, **2-wire-dc**, or **3-wire**.

**ATMS Thresholds form**

Page Y of X

ATMS THRESHOLDS

TTL Type: 105-w-rl \_\_\_\_\_ Far End Test No: \_\_\_\_\_  
 TTL Vendor: \_\_\_\_\_ TTL Contact: \_\_\_\_\_  
 Trunk Vendor: \_\_\_\_\_ Trunk Contact: \_\_\_\_\_  
 Trunk Length: \_\_\_\_\_

|                          | MARGINAL |      | UNACCEPTABLE |      |
|--------------------------|----------|------|--------------|------|
|                          | Min      | Max  | Min          | Max  |
| 1004 Hz Loss:            | -2       | 21   | -2           | 21   |
|                          | -Dev     | +Dev | -Dev         | +Dev |
| 404 Hz Loss:             | 9        | 9    | 9            | 9    |
| 2804 Hz Loss:            | 9        | 9    | 9            | 9    |
| Maximum C Message Noise: | 55       |      | 55           |      |
| Maximum C Notched Noise: | 74       |      | 74           |      |
| Minimum SRL-HI:          | 0_       |      | 0_           |      |
| Minimum SRL-LO:          | 0_       |      | 0_           |      |
| Minimum ERL:             | 0_       |      | 0_           |      |

Allow ATMS Busyout, Error Logging and Alarming? y  
 Maximum Percentage of Trunks Which Can Be Removed from Service by ATMS: 0\_

**Screen 7-37. CO Trunk Group ATMS Thresholds form**

**Group Member Assignments form**

Page Y of X

TRUNK GROUP  
 Administered Members(min/max): xxx/yyy  
 Total Administered Members: xxx

GROUP MEMBER ASSIGNMENTS

|     | Port  | Code  | Sfx | Name  | Night | Mode  | Type  | Ans Delay |
|-----|-------|-------|-----|-------|-------|-------|-------|-----------|
| 1:  | _____ | _____ | -   | _____ | _____ | _____ | _____ | _____     |
| 2:  | _____ | _____ | -   | _____ | _____ | _____ | _____ | _____     |
| 3:  | _____ | _____ | -   | _____ | _____ | _____ | _____ | _____     |
| 4:  | _____ | _____ | -   | _____ | _____ | _____ | _____ | _____     |
| 5:  | _____ | _____ | -   | _____ | _____ | _____ | _____ | _____     |
| 6:  | _____ | _____ | -   | _____ | _____ | _____ | _____ | _____     |
| 7:  | _____ | _____ | -   | _____ | _____ | _____ | _____ | _____     |
| 8:  | _____ | _____ | -   | _____ | _____ | _____ | _____ | _____     |
| 9:  | _____ | _____ | -   | _____ | _____ | _____ | _____ | _____     |
| 10: | _____ | _____ | -   | _____ | _____ | _____ | _____ | _____     |
| 11: | _____ | _____ | -   | _____ | _____ | _____ | _____ | _____     |
| 12: | _____ | _____ | -   | _____ | _____ | _____ | _____ | _____     |
| 13: | _____ | _____ | -   | _____ | _____ | _____ | _____ | _____     |
| 14: | _____ | _____ | -   | _____ | _____ | _____ | _____ | _____     |
| 15: | _____ | _____ | -   | _____ | _____ | _____ | _____ | _____     |

**Screen 7-38. CO Group Member Assignments form**

## CPE trunk group

---

This form provides access between DEFINITY ECS and customer-provided equipment (CPE).

The auxiliary trunk ports that are used to connect CPE to the switch are administered as CPE trunk group members. Some features can be assigned to the system using other system forms. For example, trunk port interfaces can be assigned on system forms for such features as Music-on-Hold Access (Feature-Related System Parameters form) and Loudspeaker Paging and Code Calling Access (Loudspeaker Paging and Code Calling Access form).

### Administration commands

---

Use the following commands to administer the CPE trunk group form.

| Action  | Object      | Qualifier <sup>1</sup>  |
|---------|-------------|---|
| add     | trunk-group | 1-MAX (or 'next')   |
| change  | trunk-group | 1-MAX or TAC X...   |
| display | trunk-group | 1-MAX ['number' X][ 'to-number' X][ 'count' N]<br>[ 'tac' assigned TAC][ 'print' or 'schedule'] |
| list    | trunk-group | [ 'print' or 'schedule']  |
| remove  | trunk-group | 1-MAX or TAC X...   |

1. Brackets [ ] indicate the qualifier is optional. Single quotes ( ' ') indicate the text inside the quote must be entered exactly as shown or an abbreviated form of the word may be entered. MAX is the maximum number available in your system configuration.

### Hardware requirements

---

A port on a TN763C auxiliary trunk circuit pack is required for each trunk assigned to the CPE trunk group. A TN763C provides 4 ports.

### Field descriptions

---

The fields on the following forms are described in ["Trunk Groups — General"](#).

## CPE Trunk Group form page 1

```

                                                                 Page 1 of X
                TRUNK GROUP
Group Number: xxx          Group Type: cpe          CDR Reports: y
  Group Name: OUTSIDE_CALL_____ COR: 1_          TN: 1__          TAC: _____
                Outgoing Display? n
  Dial Access? n          Busy Threshold: 99
  Queue Length: 0__

TRUNK PARAMETERS

                                Disconnect Timing(msec): 500_

  End-to-End Signaling: 60_

  Answer Supervision Timeout: _10
```

### Screen 7-39. CPE Trunk Group form (Page 1)

#### Fields unique to this form

The following field is unique to the CPE Trunk Group form.

- **End-to-End Signaling** — Specifies the duration (in ms) of touch-tone signal tone that is sent to the far-end for interpretation by devices at that location. Valid entries are **60** to **360** in increments of 10, or leave blank; default is **60**.



#### NOTE:

For trunks that do not receive real answer supervision, a “connect” Event report is sent when the Answer Supervision Timeout occurs.

## CPE Trunk Group form page 2

Page 2 of X

TRUNK GROUP

TRUNK FEATURES

|                          |                     |                      |
|--------------------------|---------------------|----------------------|
| ACA Assignment? n        | Measured: none      | Maintenance Tests? y |
|                          | Data Restriction? n |                      |
| Suppress # Outpulsing? n |                     |                      |

### Screen 7-40. CPE Trunk Group form (page 2)

## Administrable Timers form

Page Y of X

TRUNK GROUP

ADMINISTRABLE TIMERS

|                                   |   |
|-----------------------------------|---|
| Incoming Disconnect(msec): 500    | Outgoing Disconnect(msec): 500              |
| Incoming Dial Guard(msec): 70     | Outgoing Dial Guard(msec): 1600             |
| Incoming Glare Guard(msec): 1500  | Outgoing Glare Guard(msec): 1500            |
|                                   | Outgoing Rotary Dial Interdigit(msec): 800_ |
| Outgoing End of Dial(sec): 10     | Outgoing Seizure Response(sec): 5           |
| Programmed Dial Pause(msec): 1500 | Disconnect Signal Error(sec): 240           |
|                                   | Incoming Incomplete Dial Alarm(sec): 255    |

END TO END SIGNALING

|                  |                   |
|------------------|-------------------|
| Tone (msec): 350 | Pause (msec): 150 |
|------------------|-------------------|

OUTPULSING TIMING

|         |                 |                  |
|---------|-----------------|------------------|
| PPS: 10 | Make (msec): 40 | Break (msec): 60 |
|---------|-----------------|------------------|

### Screen 7-41. CPE Trunk Group Administrable Timers form

**ATMS Thresholds form**

Page Y of X

ATMS THRESHOLDS

TTL Type: 105-w-rl\_\_\_\_\_ Far End Test No: \_\_\_\_\_  
 TTL Vendor: \_\_\_\_\_ TTL Contact: \_\_\_\_\_  
 Trunk Vendor: \_\_\_\_\_ Trunk Contact: \_\_\_\_\_  
 Trunk Length: \_\_\_\_\_

|                          | MARGINAL |      | UNACCEPTABLE |      |
|--------------------------|----------|------|--------------|------|
|                          | Min      | Max  | Min          | Max  |
| 1004 Hz Loss:            | -2       | 21   | -2           | 21   |
|                          | -Dev     | +Dev | -Dev         | +Dev |
| 404 Hz Loss:             | 9        | 9    | 9            | 9    |
| 2804 Hz Loss:            | 9        | 9    | 9            | 9    |
| Maximum C Message Noise: | 55       |      | 55           |      |
| Maximum C Notched Noise: | 74       |      | 74           |      |
| Minimum SRL-HI:          | 0_       |      | 0_           |      |
| Minimum SRL-LO:          | 0_       |      | 0_           |      |
| Minimum ERL:             | 0_       |      | 0_           |      |

Allow ATMS Busyout, Error Logging and Alarming? y  
 Maximum Percentage of Trunks Which Can Be Removed from Service by ATMS: 0\_

**Screen 7-42. CPE Trunk Group ATMS Thresholds form**

**Group Member Assignments form**

Page Y of X

TRUNK GROUP

Administered Members(min/max): xxx/yyy  
 Total Administered Members: xxx

GROUP MEMBER ASSIGNMENTS

|     | Port  | Code  | Sfx | Name  |
|-----|-------|-------|-----|-------|
| 1:  | _____ | _____ | -   | _____ |
| 2:  | _____ | _____ | -   | _____ |
| 3:  | _____ | _____ | -   | _____ |
| 4:  | _____ | _____ | -   | _____ |
| 5:  | _____ | _____ | -   | _____ |
| 6:  | _____ | _____ | -   | _____ |
| 7:  | _____ | _____ | -   | _____ |
| 8:  | _____ | _____ | -   | _____ |
| 9:  | _____ | _____ | -   | _____ |
| 10: | _____ | _____ | -   | _____ |
| 11: | _____ | _____ | -   | _____ |
| 12: | _____ | _____ | -   | _____ |
| 13: | _____ | _____ | -   | _____ |
| 14: | _____ | _____ | -   | _____ |
| 15: | _____ | _____ | -   | _____ |

**Screen 7-43. CPE Group Member Assignments form**

## DID trunk group

---

The Direct Inward Dialing (DID) trunk group form allows an incoming call from the exchange network to reach a specific extension number directly without attendant intervention. DID features are also supported over Main/Satellite TGU/TGE trunks.

On the Feature-Related System Parameters form, you can set DID/Tie/ISDN Intercept Treatment to handle calls that do not complete.

### Administration commands

---

Use the following commands to administer the DID trunk group form.

| Action  | Object      | Qualifier <sup>1</sup>   |
|---------|-------------|--|
| add     | trunk-group | 1—MAX (or 'next')  |
| change  | trunk-group | 1—MAX or TAC X...  |
| display | trunk-group | 1—MAX ['number' X][ 'to-number' X][ 'count' N] [ 'tac' assigned TAC][ 'print' or 'schedule'] |
| list    | trunk-group | [ 'print' or 'schedule']   |
| remove  | trunk-group | 1—MAX or TAC X...  |

1. Brackets [ ] indicate the qualifier is optional. Single quotes ( ' ') indicate the text inside the quote must be entered exactly as shown or an abbreviated form of the word may be entered. MAX is the maximum number available in your system configuration.

### Hardware requirements

---

The following 8-port circuit packs are available:

- TN753 (used with Country code 1 and 23)
- TN436 (used with Country code 2)
- TN459 (used with Country code 10)
- TN2139 (used with Country code 4)
- TN2146 (used with Country code 5 and 8)
- TN2184 (used with Country code 13)
- TN464 DS1 and TN767 DS1
- TN2199



## How to administer DID trunk groups

### Required forms

| Form                              | Field  | Page                  |
|-----------------------------------|--|-----------------------|
| Trunk Group (DID)                 | ■ All  | <a href="#">7-178</a> |
| Feature-Related System Parameters | ■ DID/Tie/ISDN Intercept Treatment<br>DID Busy Treatment | <a href="#">5-123</a> |

- Trunk Group (DID) — Verify or complete all fields.
- Feature-Related System Parameters — Complete DID/Tie/ISDN Intercept Treatment and DID Busy Treatment to specify call handling for invalid DID calls or DID calls that terminate to a busy station.

### Field descriptions

The fields on the following forms are described in [“Trunk Groups — General”](#).

#### DID trunk group form page 1

```

                                     Page 1 of X
                                TRUNK GROUP

Group Number: xxx                Group Type: did  CDR Reports: y
Group Name: Did - Incoming DTMF ANI  COR: 1_  TN: 1__  TAC: ____

                                Country: 14
                                Auth Code? n

TRUNK PARAMETERS
  Trunk Type: _____ Incoming Rotary Timeout(sec): 5_
                                Incoming Dial Type: tone_
Trunk Termination: rc_____ Disconnect Timing(msec): 500_
Digit Treatment: _____ Digits: ____
Expected Digits: __           Sig Bit Inversion: none
Terminal Balanced? n          RA Trunk Loss: 0db
Extended Loop Range? n  Trunk Gain: high      Drop Treatment: silence

Disconnect Supervision - In? y
    
```

Screen 7-44. DID Trunk Group form (page 1)

## Fields unique to this form

The following field is unique to the DID trunk group form.

- Extended Loop Range** — This field appears only on a DID trunk group and only for the TN459A circuit pack. Enter **y** or **n** (default) depending on the distance between the central office and the switch. If greater than the required distance, then the field should be **y**.

## Implementation notes

Dial Detection displays when Country Code is **15** and Trunk Type is **2-wire-ac**, **2-wire-dc**, or **3-wire**.

## DID trunk group form page 2

```

change trunk-group 1                                     Page 2 of X
TRUNK FEATURES
  ACA Assignment? n                                     Measured: none
                                                    Maintenance Tests? y
  Data Restriction? n
  Suppress # Outpulsing? n
  Charge Conversion: 1                                 Shuttle? y
  Decimal Point: none                                 Start B Signal: 1
  Currency Symbol: ____                               Request Category? n
  Charge Type: ____                                   Receive Analog Incoming Call ID? disabled
Incoming Tone (DTMF) ANI: no                         Per Call CPN Blocking Code: ____
                                                    Per Call CPN Unblocking Code: ____
  
```

### Screen 7-45. DID Trunk Group form (Page 2)

## Implementation notes

Shuttle displays when Country Code is **15** and Incoming Dial Type is **rotary**. When Shuttle is **y**, Request Category and Start B Signal also display.

In Incoming Tone (DTMF) ANI, enter **y** to activate the Inband ANI/DNIS feature. Default is **n**.

## Administrable Timers form

```

                                                                 Page Y of X
                                TRUNK GROUP
ADMINISTRABLE TIMERS
  Incoming Disconnect(msec): 500
  Incoming Dial Guard(msec): 70
  Incoming Partial Dial(sec): 18

                                Flash Length(msec): 540
                                Incoming Incomplete Dial Alarm(sec): 255

END TO END SIGNALING
  Tone(msec): 350      Pause(msec): 150
OUTPULSING INFORMATION
  PPS: 10      Make (msec): 40      Break (msec): 60
```

### Screen 7-46. DID Trunk Group Administrable Timers form

#### Implementation notes

Incoming Seizure displays when Country Code is **"15"** and Trunk Type is **2-wire-ac, 2-wire-dc, or 3-wire**. These three trunk types must be on a TN2199 circuit board.

Disconnect Signal Error also displays when Country Code is **15** and Trunk Type is **2-wire-ac, 2-wire-dc, or 3-wire**.

Answer Send displays when Country Code is **15** and Trunk Type is **2-wire-ac, 2-wire-dc, or 3-wire**.

## Group Member Assignments form

Page Y of X

TRUNK GROUP

Administered Members(min/max): xxx/yyy

Total Administered Members: xxx

GROUP MEMBER ASSIGNMENTS

|      | Port  | Code  | Sfx | Name  |
|------|-------|-------|-----|-------|
| 226: | _____ | _____ | -   | _____ |
| 227: | _____ | _____ | -   | _____ |
| 228: | _____ | _____ | -   | _____ |
| 229: | _____ | _____ | -   | _____ |
| 230: | _____ | _____ | -   | _____ |
| 231: | _____ | _____ | -   | _____ |
| 232: | _____ | _____ | -   | _____ |
| 233: | _____ | _____ | -   | _____ |
| 234: | _____ | _____ | -   | _____ |
| 235: | _____ | _____ | -   | _____ |
| 236: | _____ | _____ | -   | _____ |
| 237: | _____ | _____ | -   | _____ |
| 238: | _____ | _____ | -   | _____ |
| 239: | _____ | _____ | -   | _____ |
| 240: | _____ | _____ | -   | _____ |

Screen 7-47. DID Group Member Assignments form

## DIOD trunk group

---

This form assigns a Direct Inward and Outward Dialing (DIOD) trunk group and associated trunk ports. It allows non-attendant-assisted incoming and outgoing calls from a local exchange. DIOD trunk groups support both voice and data transmissions. To use data transmissions over digital DIOD trunk groups, set the `Comm Type` field to **data** or **avd**.

On the Feature-Related System Parameters form, you can set DID/Tie/ISDN Intercept Treatment to handle calls that do not complete.

### Administration commands

---

Use the following commands to administer the DIOD trunk group form.

| Action  | Object      | Qualifier <sup>1</sup>  |
|---------|-------------|---|
| add     | trunk-group | 1—MAX (or 'next')   |
| change  | trunk-group | 1—MAX or TAC X...   |
| display | trunk-group | 1—MAX ['number' X][ 'to-number' X][ 'count' N]<br>[ 'tac' assigned TAC][ 'print' or 'schedule'] |
| list    | trunk-group | [ 'print' or 'schedule']  |
| remove  | trunk-group | 1—MAX or TAC X...   |

- 
1. Brackets [ ] indicate the qualifier is optional. Single quotes ( ' ') indicate the text inside the quote must be entered exactly as shown or an abbreviated form of the word may be entered. MAX is the maximum number available in your system configuration.

### Hardware requirements

---

- TN429 analog (with Country code 3)
- TN2184 analog with PPM detection (with Country code 13)
- TN464D digital with a bit rate of at least 2.048 Mbps

## How to administer DIOD trunk groups

### Required forms

| Form                              | Field  | Page                  |
|-----------------------------------|--|-----------------------|
| Trunk Group (DIOD)                | ■ All  | <a href="#">7-183</a> |
| Feature-Related System Parameters | ■ DID/Tie/ISDN Intercept Treatment<br>■ DOD Busy Treatment | <a href="#">5-123</a> |

- Trunk Group (DIOD) — Verify or complete all fields. The group type field must contain “diod.”
- Feature-Related System Parameters — Complete DID/Tie/ISDN Intercept Treatment and DID Busy Treatment to specify call handling for invalid DID calls or DID calls that terminate to a busy station.

### Field Descriptions

The fields on the following forms are described in [“Trunk Groups — General”](#).

### DIOD trunk group form page 1

```

                                                                 Page 1 of X
                                     TRUNK GROUP

Group Number: xxx                               Group Type: diod                               CDR Reports: y
Group Name: Did - Incoming DTMF ANU             COR: 1_                               TN: 1__                               TAC: ___
Direction: two-way_                             Outgoing Display? n
Dial Access? n                                  Busy Threshold: 99_
Queue Length: 0__                               Country: 1_
Comm Type: ___                                  Auth Code? n                            Digit Absorption List: _
Prefix-1? y                                     Trunk Flash? n                          Toll Restricted? y
BCC: 0

TRUNK PARAMETERS
Trunk Type: _____
Outgoing Dial Type: tone_____                Incoming Dial Type: tone_
Trunk Termination: rc_____
Digit Treatment: _____                    Digits: _____
Expected Digits: ___                            Sig Bit Inversion: none
Terminal Balanced? n                            RA Trunk Loss: 0db
                                                Trunk Gain: high                          Drop Treatment: silence
                                                Bit Rate: 1200                             Synchronization: _____ Duplex: _____
Disconnect Supervision - In? y Out? n           Cyclical Hunt? n
Answer Supervision Timeout: 10_                 Receive Answer Supervision? n
```

## Implementation notes

---

Terminal Balanced and Cyclical Hunt only display when Trunk Type is **loop-start**.

Enter **loop-start** in Trunk Type for analog DIOD trunk ports. All analog members of this group must be on TN429 (Japan) or TN2184 (Germany) circuit packs. All digital members of this group must be TN464Dv2 or later.

Enter **immed-start** or **wink-start** in Trunk Type for digital DIOD trunk ports.

## DIOD trunk group form page 2

```
change trunk-group 1                                     Page 2 of X

                                TRUNK GROUP
TRUNK FEATURES
  ACA Assignment? n                               Measured: none
                                                Maintenance Tests? y
                                Data Restriction? n

  Suppress # Outpulsing? n
  Charge Conversion: 1                               Shuttle? y
    Decimal Point: none                             Start B Signal: 1
  Currency Symbol: _____ Request Category? n
  Charge Type: _____ Receive Analog Incoming Call ID? disabled
Incoming Tone (DTMF) ANI: no                       Per Call CPN Blocking Code: _____
                                                Per Call CPN Unblocking Code: _____
```

## Screen 7-49. DID Trunk Group form (Page 2)

### Implementation note

---

Shuttle displays when Country Code is **15**, Incoming Dial Type is **rotary**, and Outgoing Dial Type is **rotary**. When Shuttle is **y**, Request Category and Start B Signal also display.

In Incoming Tone (DTMF) ANI, enter **y** to activate the Inband ANI/DNIS feature. Default is **n**.

### Administrable Timers form

Page Y of X

```

ADMINISTRABLE TIMERS
  Incoming Disconnect(msec): 500          Outgoing Disconnect(msec): 500
  Incoming Dial Guard (msec): ___         Outgoing Dial Guard(msec): 1600
  Incoming Glare Guard(msec): 1500       Outgoing Glare Guard(msec): 1500
                                           Outgoing Rotary Dial Interdigit(msec): 800
  Ringing Monitor(msec): 5200            Incoming Seizure(msec): 500
  Outgoing End of Dial(sec): 10           Outgoing Seizure Response(sec): 5
  Programmed Dial Pause(msec): 1500
  Flash Length (msec): ___               Incoming Incomplete Dial Alarm (sec): ___

END TO END SIGNALING
  Tone(msec): 350                        Pause(msec): 150

OUTPULSING INFORMATION
  PPS: 10   Make(msec): 40   Break(msec): 60   PPM? y
    
```

Screen 7-50. DIOD Trunk Group Administrable Timers form

### ATMS Thresholds form

Page Y of X

```

ATMS THRESHOLDS
  TTL Type: 105-w-rl_____   Far End Test No: _____
  TTL Vendor: _____       TTL Contact: _____
  Trunk Vendor: _____     Trunk Contact: _____
  Trunk Length: _____

MARGINAL                               UNACCEPTABLE
  Min   Max                             Min   Max
1004 Hz Loss: -2   21                   -2   21

  -Dev +Dev                             -Dev +Dev
  404 Hz Loss: 9   9                       9   9
  2804 Hz Loss: 9   9                       9   9

Maximum C Message Noise:                55
Maximum C Notched Noise:                 74
Minimum SRL-HI:                          0_
Minimum SRL-LO:                          0_
Minimum ERL:                              0_

Allow ATMS Busyout, Error Logging and Alarming? y
Maximum Percentage of Trunks Which Can Be Removed from Service by ATMS: 0_
    
```

Screen 7-51. DIOD Trunk Group ATMS Thresholds form



## Group Member Assignments form

|                          |       |      |     |       |       |       |  |
|--------------------------|-------|------|-----|-------|-------|-------|--|
|                          |       |      |     |       |       |       | Page Y of X                            |
|                          |       |      |     |       |       |       | TRUNK GROUP                            |
|                          |       |      |     |       |       |       | Administered Members(min/max): xxx/yyy |
|                          |       |      |     |       |       |       | Total Administered Members: xxx        |
| GROUP MEMBER ASSIGNMENTS | Port  | Code | Sfx | Name  | Mode  | Type  | Ans Delay                              |
| 1:                       | _____ |      |     | _____ | _____ | _____ | _____                                  |
| 2:                       | _____ |      |     | _____ | _____ | _____ | _____                                  |
| 3:                       | _____ |      |     | _____ | _____ | _____ | _____                                  |
| 4:                       | _____ |      |     | _____ | _____ | _____ | _____                                  |
| 5:                       | _____ |      |     | _____ | _____ | _____ | _____                                  |
| 6:                       | _____ |      |     | _____ | _____ | _____ | _____                                  |
| 7:                       | _____ |      |     | _____ | _____ | _____ | _____                                  |
| 8:                       | _____ |      |     | _____ | _____ | _____ | _____                                  |
| 9:                       | _____ |      |     | _____ | _____ | _____ | _____                                  |
| 10:                      | _____ |      |     | _____ | _____ | _____ | _____                                  |
| 11:                      | _____ |      |     | _____ | _____ | _____ | _____                                  |
| 12:                      | _____ |      |     | _____ | _____ | _____ | _____                                  |
| 13:                      | _____ |      |     | _____ | _____ | _____ | _____                                  |
| 14:                      | _____ |      |     | _____ | _____ | _____ | _____                                  |
| 15:                      | _____ |      |     | _____ | _____ | _____ | _____                                  |

Screen 7-52. DIOD Group Member Assignments form

### Implementation note

All DIOD analog trunk group members must be on TN429 (Japan) or TN2184 (Germany) circuit packs. All digital members of this group must be TN464Dv2 or later.

## DMI-BOS trunk group

---

The Digital Multiplexed Interface Bit-Oriented Signaling (DMI-BOS) trunk group form allows communications to/from the system using DMI-BOS protocol.

### Administration commands

---

Use the following commands to administer the DMI-BOS trunk group form.

| Action  | Object      | Qualifier <sup>1</sup>  |
|---------|-------------|---|
| add     | trunk-group | 1-MAX (or 'next')   |
| change  | trunk-group | 1-MAX or TAC X...   |
| display | trunk-group | 1-MAX ['number' X]['to-number' X]['count' N]<br>['tac' assigned TAC]['print' or 'schedule'] |
| list    | trunk-group | ['print' or 'schedule']   |
| remove  | trunk-group | 1-MAX or TAC X...   |

1. Brackets [ ] indicate the qualifier is optional. Single quotes ( ' ' ) indicate the text inside the quote must be entered exactly as shown or an abbreviated form of the word may be entered. MAX is the maximum number available in your system configuration.

### Field descriptions

---

The fields on the following forms are described in ["Trunk Groups — General"](#).



wink-start trunks or increasing the dial-guard timer value on the far-end switch avoids this problem.

## DMI-BOS trunk group form page 2

```

change trunk-group 1                                     Page 2 of X

                                TRUNK GROUP

TRUNK FEATURES
    ACA Assignment? n                                Measured: none
                                                    Maintenance Tests? y
                                Data Restriction? n

    Suppress # Outpulsing? n
    Charge Conversion: 1                                Shuttle? y
    Decimal Point: none                                Start B Signal: 1
    Currency Symbol: _____ Request Category? n
    Charge Type: _____ Receive Analog Incoming Call ID? disabled
Incoming Tone (DTMF) ANI: no                        Per Call CPN Blocking Code: _____
                                                    Per Call CPN Unblocking Code: _____
    
```

### Screen 7-54. DMI-BOS Trunk Group form (Page 2)

#### Implementation notes

In Incoming Tone (DTMF) ANI, enter **y** to activate the Inband ANI/DNIS feature. Default is **n**.

#### Administrable Timers form

```

                                TRUNK GROUP                                     Page Y of X

ADMINISTRABLE TIMERS
Incoming Disconnect(msec): 500                    Outgoing Dial Guard (msec): 500
Incoming Dial Guard(msec): 70                      Outgoing Dial Guard(msec): 1600
Incoming Glare Guard(msec): 1500                   Outgoing Glare Guard(msec): 1500
Incoming Partial Dial(sec): 18

Outgoing Rotary Dial Interdigit (msec): 800
Outgoing End of Dial (sec): 10                     Outgoing Seizure Response (sec): 5
Programmed Dial Pause (msec): 1500                 Disconnect Signal Error(sec): 240
                                                    Incoming Incomplete Dial Alarm(sec): 255

END TO END SIGNALING
Tone (msec): 350      Pause (msec): 150

OUTPUTSING TIMING
PPS: 10              Make (msec): 40              Break (msec): 60
    
```

### Screen 7-55. DMI-BOS Trunk Group Administrable Timers form

## Implementation notes

---

Outgoing End of Dial only appears if Receive Answer Supervision is **y**.

Outgoing Disconnect displays only if Direction is **outgoing** or **two-way**.

## ATMS Thresholds form

| ATMS THRESHOLDS  |                        |      |              |      |
|--|------------------------|------|--------------|------|
| TTL Type: 105-w-rl_____  | Far End Test No: _____ |      |              |      |
| TTL Vendor: _____  | TTL Contact: _____     |      |              |      |
| Trunk Vendor: _____  | Trunk Contact: _____   |      |              |      |
| Trunk Length: ____   |                        |      |              |      |
|  | MARGINAL               |      | UNACCEPTABLE |      |
|  | Min                    | Max  | Min          | Max  |
| 1004 Hz Loss:  | -2                     | 21   | -2           | 21   |
|  | -Dev                   | +Dev | -Dev         | +Dev |
| 404 Hz Loss:   | 9                      | 9    | 9            | 9    |
| 2804 Hz Loss:  | 9                      | 9    | 9            | 9    |
| Maximum C Message Noise:   | 55                     |      | 55           |      |
| Maximum C Notched Noise:   | 74                     |      | 74           |      |
| Minimum SRL-HI:  | 0_                     |      | 0_           |      |
| Minimum SRL-LO:  | 0_                     |      | 0_           |      |
| Minimum ERL:   | 0_                     |      | 0_           |      |
| Allow ATMS Busyout, Error Logging and Alarming? y                          |                        |      |              |      |
| Maximum Percentage of Trunks Which Can Be Removed from Service by ATMS: 0_ |                        |      |              |      |

Screen 7-56. DMI-BOS Trunk Group ATMS Thresholds form

### Group Member Assignments form

|                          |       |       |     |       |       |       |       |  |
|--------------------------|-------|-------|-----|-------|-------|-------|-------|--|
|                          |       |       |     |       |       |       |       | Page Y of X                            |
|                          |       |       |     |       |       |       |       | TRUNK GROUP                            |
|                          |       |       |     |       |       |       |       | Administered Members(min/max): xxx/yyy |
|                          |       |       |     |       |       |       |       | Total Administered Members: xxx        |
| GROUP MEMBER ASSIGNMENTS | Port  | Code  | Sfx | Name  | Night | Mode  | Type  | Ans Delay                              |
| 1:                       | _____ | _____ | -   | _____ | _____ | _____ | _____ | _____                                  |
| 2:                       | _____ | _____ | -   | _____ | _____ | _____ | _____ | _____                                  |
| 3:                       | _____ | _____ | -   | _____ | _____ | _____ | _____ | _____                                  |
| 4:                       | _____ | _____ | -   | _____ | _____ | _____ | _____ | _____                                  |
| 5:                       | _____ | _____ | -   | _____ | _____ | _____ | _____ | _____                                  |
| 6:                       | _____ | _____ | -   | _____ | _____ | _____ | _____ | _____                                  |
| 7:                       | _____ | _____ | -   | _____ | _____ | _____ | _____ | _____                                  |
| 8:                       | _____ | _____ | -   | _____ | _____ | _____ | _____ | _____                                  |
| 9:                       | _____ | _____ | -   | _____ | _____ | _____ | _____ | _____                                  |
| 10:                      | _____ | _____ | -   | _____ | _____ | _____ | _____ | _____                                  |
| 11:                      | _____ | _____ | -   | _____ | _____ | _____ | _____ | _____                                  |
| 12:                      | _____ | _____ | -   | _____ | _____ | _____ | _____ | _____                                  |
| 13:                      | _____ | _____ | -   | _____ | _____ | _____ | _____ | _____                                  |
| 14:                      | _____ | _____ | -   | _____ | _____ | _____ | _____ | _____                                  |
| 15:                      | _____ | _____ | -   | _____ | _____ | _____ | _____ | _____                                  |

Screen 7-57. DMI-BOS Group Member Assignments form

## FX trunk group

The Foreign Exchange (FX) trunk group allows a connection between a distant central office and DEFINITY ECS.

If the CO is a step-by-step office, complete the Digit Absorption form. The Digit Absorption List field on the Central Office trunk group form must reference the Digit Absorption List Number.

### Administration commands

Use the following commands to administer the FX trunk group form.

| Action  | Object      | Qualifier <sup>1</sup>  |
|---------|-------------|---|
| add     | trunk-group | 1-MAX (or 'next')   |
| change  | trunk-group | 1-MAX or TAC X...   |
| display | trunk-group | 1-MAX ['number' X]['to-number' X]['count' N]<br>['tac' assigned TAC]['print' or 'schedule'] |
| list    | trunk-group | ['print' or 'schedule']   |
| remove  | trunk-group | 1-MAX or TAC X...   |

1. Brackets [ ] indicate the qualifier is optional. Single quotes ( ' ' ) indicate the text inside the quote must be entered exactly as shown or an abbreviated form of the word may be entered. MAX is the maximum number available in your system configuration.

### Hardware requirements

A port is required on a TN747B CO trunk, or TN464D or TN767 DS1 circuit pack for each trunk assigned to a FX trunk group. A TN747B provides 8 ports, a TN767 provides 24 ports, and a TN464D provides either 24 or 32 ports.

### How to administer FX trunk groups

#### Required forms

| Form             | Field | Page                  |
|------------------|-------|-----------------------|
| Trunk Group (FX) | ■ All | <a href="#">7-193</a> |
| Digit Absorption | ■ All | <a href="#">7-91</a>  |

- Trunk Group (FX) — Complete all fields.
- Digit Absorption — If required, complete this form when the far-end central office is a step-by-step office. Digit Absorption List on the Foreign Exchange trunk group must reference the Digit Absorption List number entered on the form.

## Field descriptions

The fields on the following forms are described in [“Trunk Groups — General”](#).

### FX trunk group form page 1

Page 1 of X

TRUNK GROUP

```

Group Number: xxx                Group Type: fx                CDR Reports: y
Group Name: OUTSIDE_CALL_____ COR: 1_                TN: 1_                TAC: ____
Direction: two-way_            Outgoing Display? n
Dial Access? n                Busy Threshold: 99_            Night Service: ____
Queue Length: 0_                Country: 5_ Version: a        Incoming Destination: ____
Comm Type: voice                Auth Code? n                Digit Absorption List: _
Prefix-1? y                    Trunk Flash? n                Toll Restricted? y
BCC: _
TRUNK PARAMETERS
Trunk Type: _____
Outgoing Dial Type: tone_____ Cut-Through? n
Trunk Termination: rc_____ Disconnect Timing(msec): 500_

Auto Guard? n                Call Still Held? n            Sig Bit Inversion: none
Terminal Balanced? n

Trunk Gain: high
Bit Rate: 1200_                Synchronization: async        Duplex: full
Disconnect Supervision - In? y Out? n
Answer Supervision Timeout: 10_ Receive Answer Supervision? n
    
```

Screen 7-58. FX Trunk Group form (page 1)

## Implementation notes

BCC only displays when Comm Type is “**avd**”, or “**rbavd**”, or ISDN-PRI is optioned for on the System-Parameters Customer-Options form and Comm Type is “**avd**”, “**data**”, or “**rbavd**.”

Synchronization only displays if Comm Type is **avd** or **rbavd**.

Terminal Balanced and Cyclical Hunt only display if Trunk Type is **loop-start**.



Dial Detection displays when Country Code is **15** and **Trunk Type** is **2-wire-ac**, **2-wire-dc** or **3-wire**.

## FX trunk group form page 2

Page 2 of X

TRUNK FEATURES

|                          |                                    |                      |
|--------------------------|------------------------------------|----------------------|
| ACA Assignment? n        | Measured: none                     | Maintenance Tests? y |
|                          | Data Restriction? n                |                      |
| Abandoned Call Search? n |                                    |                      |
| Suppress # Outpulsing? n |                                    |                      |
| Charge Conversion: 1     |                                    | Shuttle? y           |
| Decimal Point: none      |                                    |                      |
| Currency Symbol: ____    |                                    | Start Position: 1    |
| Charge Type: ____        |                                    |                      |
|                          | Per Call CPN Blocking Code: ____   |                      |
|                          | Per Call CPN Unblocking Code: ____ |                      |

### Screen 7-59. FX Trunk Group form (page 2)

#### Implementation note

Shuttle displays when Country Code is **15** and Outgoing Dial Type is **rotary**.

Start Position displays when Shuttle is **y**.

## Administrable Timers form

| TRUNK GROUP                       |  | Page Y of X            |
|-----------------------------------|--|------------------------|
| ADMINISTRABLE TIMERS              |  |                        |
| Incoming Disconnect(msec): 500    | Outgoing Disconnect(msec): 500             |                        |
|                                   | Outgoing Dial Guard(msec): 1600            |                        |
| Incoming Glare Guard(msec): 1500  | Outgoing Glare Guard(msec): 1500           |                        |
|                                   | Outgoing Rotary Dial Interdigit(msec): 800 |                        |
| Ringing Monitor(msec): 5200       | Incoming Seizure(msec): 500                |                        |
| Outgoing End of Dial(sec): 10     | Outgoing Seizure Response(sec): 5          |                        |
| Programmed Dial Pause(msec): 1500 | Disconnect Signal Error(sec): 240          |                        |
| Flash Length(msec): 540           |  |                        |
|                                   |  |                        |
| END TO END SIGNALING              |  |                        |
| Tone (msec): 350                  | Pause (msec): 150                          |                        |
|                                   |  |                        |
| OUTPULSING INFORMATION            |  |                        |
| PPS: 10                           | Make(msec): 40                             | Break(msec): 60 PPM? y |

### Screen 7-60. FX Trunk Group Administrable Timers form

#### Implementation notes

---

PPM only displays when Direction is **outgoing** or **two-way**.

Frequency only displays when PPM is **y**.

Outgoing Disconnect displays if Direction is **outgoing** or **two-way** and Trunk Type is **ground-start** or **loop-start**.

Outgoing Disconnect also displays if Direction is **outgoing** or **two-way**, Country Code is **15**, and Trunk Type is **2-wire-ac**, **2-wire-dc**, or **3-wire**.

### ATMS Thresholds form

Page Y of X

ATMS THRESHOLDS

TTL Type: 105-w-rl\_\_\_\_\_ Far End Test No: \_\_\_\_\_  
 TTL Vendor: \_\_\_\_\_ TTL Contact: \_\_\_\_\_  
 Trunk Vendor: \_\_\_\_\_ Trunk Contact: \_\_\_\_\_  
 Trunk Length: \_\_\_\_\_

|                          | MARGINAL |      | UNACCEPTABLE |      |
|--------------------------|----------|------|--------------|------|
|                          | Min      | Max  | Min          | Max  |
| 1004 Hz Loss:            | -2       | 21   | -2           | 21   |
|                          | -Dev     | +Dev | -Dev         | +Dev |
| 404 Hz Loss:             | 9        | 9    | 9            | 9    |
| 2804 Hz Loss:            | 9        | 9    | 9            | 9    |
| Maximum C Message Noise: | 55       |      | 55           |      |
| Maximum C Notched Noise: | 74       |      | 74           |      |
| Minimum SRL-HI:          | 0_       |      | 0_           |      |
| Minimum SRL-LO:          | 0_       |      | 0_           |      |
| Minimum ERL:             | 0_       |      | 0_           |      |

Allow ATMS Busyout, Error Logging and Alarming? y  
 Maximum Percentage of Trunks Which Can Be Removed from Service by ATMS: 0\_

### Screen 7-61. FX Trunk Group ATMS Thresholds form

### Group Member Assignments form

Page Y of X

TRUNK GROUP  
 Administered Members(min/max): xxx/yyy  
 Total Administered Members: xxx

GROUP MEMBER ASSIGNMENTS

|     | Port  | Code  | Sfx | Name  | Night Mode | Type  | Ans Delay |
|-----|-------|-------|-----|-------|------------|-------|-----------|
| 1:  | _____ | _____ | -   | _____ | _____      | _____ | _____     |
| 2:  | _____ | _____ | -   | _____ | _____      | _____ | _____     |
| 3:  | _____ | _____ | -   | _____ | _____      | _____ | _____     |
| 4:  | _____ | _____ | -   | _____ | _____      | _____ | _____     |
| 5:  | _____ | _____ | -   | _____ | _____      | _____ | _____     |
| 6:  | _____ | _____ | -   | _____ | _____      | _____ | _____     |
| 7:  | _____ | _____ | -   | _____ | _____      | _____ | _____     |
| 8:  | _____ | _____ | -   | _____ | _____      | _____ | _____     |
| 9:  | _____ | _____ | -   | _____ | _____      | _____ | _____     |
| 10: | _____ | _____ | -   | _____ | _____      | _____ | _____     |
| 11: | _____ | _____ | -   | _____ | _____      | _____ | _____     |
| 12: | _____ | _____ | -   | _____ | _____      | _____ | _____     |
| 13: | _____ | _____ | -   | _____ | _____      | _____ | _____     |
| 14: | _____ | _____ | -   | _____ | _____      | _____ | _____     |
| 15: | _____ | _____ | -   | _____ | _____      | _____ | _____     |

### Screen 7-62. FX Group Member Assignments form

## ISDN-BRI trunk group

This form assigns an Integrated Services Digital Network-Basic Rate Interface (ISDN-BRI) trunk group that supports the ISDN-BRI and Call-by-Call Service Selection features. The trunk group provides end-to-end digital connectivity and supports a wide range of services including voice and non-voice services, to which users have access by a limited set of CCITT-defined, standard multipurpose interfaces.

Calls can be processed to a variety of switched nodal services such as MEGACOM telecommunications service, WATS, and ACCUNET digital service and calls destined for different interexchange carriers.

### Administration commands

When an ISDN-BRI trunk connects two switches, the trunk options should be set identically at both ends of the administer connection. Use the following commands to administer the ISDN-BRI trunk group form connection.

| Action  | Object      | Qualifier   |
|---------|-------------|---|
| add     | trunk-group | 1-MAX (or 'next')   |
| change  | trunk-group | 1-MAX or tac X...   |
| display | trunk-group | 1-MAX ['number' X]['to-number' X]['count' N]<br>['tac' assigned TAC]['print' or 'schedule'] |
| list    | trunk-group | ['print' or 'schedule']   |
| remove  | trunk-group | 1-MAX or tac X...   |

### Hardware requirements

ISDN-BRI is supported by the TN2185 Trunk-side BRI circuit pack (for implementing the user side of the BRI interface) and by the TN556B or TN556C ISDN-BRI Line circuit pack or the TN2198 ISDN BRI (U-LT) Line circuit pack (for the network side of the BRI interface).

- For R6si and later configurations and R6vs and later configurations, the D-channel switches through the TN778 Packet Control (PACCON) circuit pack. See [Table 7-8](#).
- For R6r and later configurations, the D-channel switches through the TN1655 Packet Interface (PKTINT) circuit pack. See [Table 7-9](#).
- A TN780 or TN2182 Tone Clock circuit pack provides synchronization for the ISDN-BRI Trunk circuit pack.

## How to administer ISDN-BRI trunk groups

**Table 7-8. Required forms for the TN778 Packet Control (PACCON) for an R6si and later configurations**

| <b>Form</b>                           | <b>Field</b>   | <b>Page</b>           |
|---------------------------------------|--|-----------------------|
| Feature-Related System Parameters     | <ul style="list-style-type: none"> <li>■ Send Non-ISDN Trunk Group Name as Connected Name?</li> <li>■ Display Connected Name/Number for ISDN DCS Calls?</li> </ul> | <a href="#">5-123</a> |
| System-Parameters Customer-Options    | <ul style="list-style-type: none"> <li>■ Version</li> <li>■ ISDN-BRI Trunks</li> <li>■ QSIG Optional Features</li> </ul>   | <a href="#">5-277</a> |
| Maintenance-Related System Parameters | <ul style="list-style-type: none"> <li>■ Packet Bus Maint</li> </ul>   | <a href="#">5-212</a> |
| Synchronization Plan                  | <ul style="list-style-type: none"> <li>■ All</li> </ul>  | <a href="#">7-112</a> |
| Trunk Group (ISDN-BRI)                | <ul style="list-style-type: none"> <li>■ All</li> </ul>  | <a href="#">7-198</a> |
| ISDN Numbering - Public/Unknown       | <ul style="list-style-type: none"> <li>■ All</li> </ul>  | <a href="#">7-95</a>  |
| ISDN Numbering - Private              | <ul style="list-style-type: none"> <li>■ All</li> </ul>  | <a href="#">7-93</a>  |
| ISDN-BRI Circuit Pack Form            | <ul style="list-style-type: none"> <li>■ All</li> </ul>  | <a href="#">5-186</a> |
| Route Pattern                         | <ul style="list-style-type: none"> <li>■ All</li> </ul>  | <a href="#">8-67</a>  |
| Hunt Groups                           | <ul style="list-style-type: none"> <li>■ ISDN Caller Display</li> </ul>  | <a href="#">5-158</a> |
| Terminating Extension Group           | <ul style="list-style-type: none"> <li>■ ISDN Caller Display</li> </ul>  | <a href="#">5-295</a> |

**Table 7-9. Required forms for a R6r and later configurations**

| Form                               | Field   | Page                  |
|------------------------------------|---|-----------------------|
| Feature-Related System Parameters  | ■ Send Non-ISDN Trunk Group Name as Connected Name? | <a href="#">5-123</a> |
|                                    | ■ Display Connected Name/Number for ISDN DCS Calls? |                       |
| System-Parameters Customer-Options | ■ Version   | <a href="#">5-277</a> |
|                                    | ■ ISDN-BRI Trunks                                   |                       |
|                                    | ■ QSIG Optional Features                            |                       |
| Synchronization Plan               | ■ All   | <a href="#">7-112</a> |
| Trunk Group (ISDN-BRI)             | ■ All   | <a href="#">7-198</a> |
| ISDN Numbering - Public/Unknown    | ■ All   | <a href="#">7-95</a>  |
| ISDN-BRI Circuit Pack Form         | ■ All   | <a href="#">5-186</a> |
| ISDN Numbering - Private           | ■ All   | <a href="#">7-93</a>  |
| Route Pattern                      | ■ All   | <a href="#">8-67</a>  |
| Hunt Groups                        | ■ ISDN Caller Display                               | <a href="#">5-158</a> |
| Terminating Extension Group        | ■ ISDN Caller Display                               | <a href="#">5-295</a> |

### Notes for Above Tables

- **System-Parameters Customer-Options** — ISDN-BRI Trunks should be enabled. The QSIG Optional Features fields may be enabled to allow appropriate administration for the Supplementary Service Protocol.
- **Feature-Related System-Parameters Features** — Set Send Non-ISDN Trunk Group Name as Connected Name and Display Connected Name/Number for ISDN DCS Calls. Default is **n**.
- **ISDN-BRI Trunk Circuit Pack** — Assign all fields as required.
- **Maintenance-Related System-Parameters** — Use this form only for a TN778. Set Packet Bus Maint to **y**.
- **ISDN-BRI Trunk Group** — Enter information in all the fields except the trunk group members. Enter the members after you establish the signaling links.

- ISDN Numbering - Public/Unknown — Complete all fields. This form supports the ISDN Call Identification Display.
- ISDN Numbering - Private — Complete all fields. This form supports the ISDN Call Identification Display.
- Routing Pattern — Complete all fields including the Supplemental ISDN Routing Information fields as required.
- Hunt Group — Complete `ISDN Caller Display` by entering either **grp-name** or **mbr-name** to specify whether the hunt group name or member name, respectively, is sent to the originating user (supports the ISDN Call Identification Display feature).
- Terminating Extension Group — Complete `ISDN Caller Display` by entering either **grp-name** or **mbr-name** to specify whether the group name or member name, respectively, is sent to the originating user (supports the ISDN Call Identification Display feature).
- Synchronization Plan — Assigns primary and secondary external synchronization sources for the ISDN-BRI Trunk circuit pack. Complete all form fields as required.

## Design Considerations

ISDN-BRI and ISDN-PRI trunks cannot be mixed in the same trunk group. Therefore, consider the following:

- The earliest trunk member (the lowest numbered one) administered will be considered correct.
- If an offending member is subsequently found (meaning the first member was BRI and a later member was PRI, or vice versa), the cursor positions on the offending member, and the following error message appears:

Cannot mix BRI and PRI ports in the same trunk group.

## Field descriptions

Many of the fields on the following forms are described in [“Trunk Groups — General”](#). If a field on this form is unique, it is listed and defined.

## ISDN-BRI trunk group form

Page 1 of X

TRUNK GROUP

Group Number: xxx                                  Group Type: isdn                                  CDR Reports: y  
Group Name: OUTSIDE\_CALL \_\_\_\_\_ COR: 1\_                                  TN: 1\_                                  TAC: \_\_\_\_  
Direction: two-way\_                                  Outgoing Display? n  
Dial Access? n                                  Busy Threshold: 99\_                                  Night Service: \_\_\_\_  
Queue Length: 0\_\_  
Service Type: \_\_\_\_\_                                  Auth Code? n                                  TestCall ITC: rest  
Usage Alloc: \_\_\_\_\_                                  Far End Test Line No: \_\_\_\_\_  
TestCall BCC: 4  
TRUNK PARAMETERS  
Codeset to Send Display: 6                                  Codeset to Send TCM,Lookahead: 6  
Max Message Size to Send: 260                                  Charge Advice: none \_\_\_\_\_  
Supplementary Service Protocol: a                                  Digit Handling(in/out):overlap/overlap  
Digit Treatment: insertion                                  Digits: 1234  
Trunk Hunt: cyclical  
Connected to Toll? n                                  STT Loss: normal                                  DTT to DCO Loss: normal  
Calling Number - Delete: \_\_\_\_ Insert: \_\_\_\_\_                                  Numbering Format: \_\_\_\_\_  
Bit Rate: 1200\_                                  Synchronization: async                                  Duplex: full  
Disconnect Supervision - In? y Out? n  
Answer Supervision Timeout: 0\_\_

## Screen 7-63. ISDN-BRI Trunk Group form (page 1)

Fields unique to this form

These fields are unique to the ISDN-BRI trunk group form.

- **Calling Number** — These three fields comprise the administrable fields for the Calling Line Identification Prefix feature. They display when Direction is **incoming** or **two-way**.
  - Delete — The number of digits to delete from the calling party number for all incoming calls on this trunk group. Valid values are any number from **1-15**, **all** or blank.
  - Insert — The specific digits prefixed to incoming calls when the calling party is a member of this trunk group. Valid values are any string of **1-15** digits or blank.
  - Numbering Format — Indicates TON/NPI encoding applied to CPN information modified by the CLI Prefix feature. This encoding does not apply to calls originating locally. Numbering Format on page two of this form applies to calls originated from this switch.

If this field is blank, DEFINITY ECS passes on the encoding received in the incoming setup message. If the incoming setup message did not contain CPN information, and digits are added, the outgoing message will contain these digits. If Numbering Format is blank in this case, the value defaults to **pub-unk**.



If `Numbering Format` on page two of this form is also administered as **unknown**, the trunk group is modified to “unk-unk” encoding of the TON/NPI. Therefore, this field also must contain a value other than “unknown.”

 **NOTE:**

The values for this field map to the Type of Numbering (TON) and Numbering Plan Identifier (NPI) values shown in [Table 7-10](#).

**Table 7-10. Numbering Format Valid Values**

| Numbering format valid values | Type of numbering (TON) | Numbering plan identifier (NPI) |
|-------------------------------|-------------------------|---------------------------------|
| blank                         | incoming TON unmodified | incoming NPI unmodified         |
| natl-pub                      | national(2)             | E.164(1)                        |
| intl-pub                      | international(1)        | E.164(1)                        |
| locl-pub                      | local/subscriber(4)     | E.164(1)                        |
| pub-unk                       | unknown(0)              | E.164(1)                        |
| lev0-pvt                      | local(4)                | Private Numbering Plan - PNP(9) |
| lev1-pvt                      | Regional Level 1(2)     | Private Numbering Plan - PNP(9) |
| lev2-pvt                      | Regional Level 2(1)     | Private Numbering Plan - PNP(9) |
| unk-unk                       | unknown(0)              | unknown(0)                      |

- **Charge Advice** — Allows you to accumulate and access charge information about a call. You must have already set `CDR Report` to **y** or **r** (ring-intvl) before changing this field from its default of **none**. You may specify one of the following options.
  - **none** — No Advice of Charge information is collected by the system.
  - **automatic** — Advice of Charge is enabled automatically for all outgoing calls over this trunk group.
  - **end-on-request** — DEFINITY ECS will request information at the end of the call for each outgoing call over this trunk group.
  - **during-on-request** — DEFINITY ECS will request information during and at the end of the call for each outgoing call over this trunk group.

Remember that receiving Advice of Charge during the call (administered as “automatic” or “during-on-request”) affects system performance because of the increased ISDN message activity on the signaling channel, which may reduce the maximum call capacity.

- **Codeset to Send Display** — This field defines the codeset for sending the information element for Display. The value depends on the type of switch the user is connected to as follows.
  - 0 — CCITT
  - 6 — Any other than CCITT or System 85 R2V4, 4E11 (default)
  - 7 — System 85 R2V4, 4E11
- **Codeset to Send TCM, Lookahead** — This field defines the codeset for sending the information element for Traveling Class Marks and Lookahead Interflow. The value depends on the type of switch the user is connected to. Valid entries are **7** for System 85 R2V4, 4E11, or newer switch types, or **6** (default) for other types.



**NOTE:**

A Traveling Class Mark (that is, the user’s FRL or the user’s trunk group FRL) is passed between tandem nodes in an ETN in the setup message only when the *Service Type* is **tandem**. It then is used by the distant tandem switch to permit access to facilities consistent with the originating user’s privileges.

- **Digit Handling (in/out)** — This field defines whether overlap receiving and overlap sending features are enabled. Set the field to overlap when you want overlap receiving or overlap sending. Set to **enbloc** when you do not want these features enabled. The first field value indicates digit receiving and the second value indicates digit sending. There are 4 possible combinations: **enbloc/enbloc** (default), **enbloc/overlap**, **overlap/enbloc**, and **overlap/overlap**.

Without overlap receiving or sending enabled, the digits on incoming and outgoing calls are sent enbloc. If *Digit Handling* is **overlap/enbloc** or **overlap/overlap**, the following results:

- Incoming Call Handling Treatment table does not appear
- *Digit Treatment* and *Digits* appear
- Warning message indicates that all Incoming Call Handling entries are removed when form is submitted
- When form is submitted with these values, all Incoming Call Handling entries are removed

- **Far End Test Line No.** — Specifies the number sent to the far-end’s ISDN test line extension. When the **test trunk long** command is issued, this exact number is sent to the far-end to establish a call that tests the integrity of the trunk member under test. The number does not pass through routing or undergo digit manipulation. The digits entered must be

what the far-end expects. For example, for an ISDN tandem trunk, the far-end test number should be a 7-digit ETN (Electronic Tandem Network) number. Up to 15 digits may be entered in this field.

- **Max Message Size to Send** — Defines the maximum size of ISDN messages sent by the switch. Currently, the system can receive 260 byte messages. Valid entries are **128, 244, 256, and 260** (default).
- **Service Type** — Indicates the service for which this trunk group is dedicated. [Table 7-11](#) provides a listing of predefined entries. In addition to the Services/Features listed in this table, any user-defined Facility Type of **0** (feature) or **1** (service) on the Network Facilities form is allowed. An entry of **cbc** is also allowed, which indicates this trunk group is used by the Call-By-Call Service Selection feature.

Up to 10 (R6si, R6vs) or 200 (R6r) ISDN-BRI and/or ISDN-PRI trunk groups can have this field administered as **cbc**.

**Table 7-11. Predefined Services/Features — ISDN**

| Administration mnemonic | Description   |
|-------------------------|---|
| access                  | A tie trunk giving access to an Electronic Tandem Network — See <a href="#">“Access trunk group”</a>  |
| accunet                 | ACCUNET Switched Digital Service — part of ACI (AT&T Communications ISDN) phase 2.  |
| cbc                     | Call-by-Call service — provides different dial plans for different services on an ISDN-BRI trunk group.   |
| dmi-mos                 | Digital multiplexed interface — message oriented signaling — See <a href="#">“DMI-BOS trunk group”</a> . Do not use for DCS with Rerouting.                                   |
| i800                    | International 800 Service — allows a subscriber to receive international calls without a charge to the call originating party.  |
| inwats                  | INWATS — provides OUTWATS-like pricing and service for incoming calls.  |
| lds                     | Long-Distance Service — part of ACI (AT&T Communications ISDN) phase 2.   |
| megacom                 | MEGACOM Service — an AT&T communications service that provides unbanded long-distance services using special access (switch to 4ESS switch) from an AT&T communications node. |
| mega800                 | MEGACOM 800 Service — an AT&T communications service that provides unbanded 800 service using special access (4ESS switch to switch) from an AT&T communications node.        |

*Continued on next page*

Table 7-11. Predefined Services/Features — ISDN — *Continued*

| Administration mnemonic | Description   |
|-------------------------|---|
| multiquest              | AT&T MULTIQUEST Telecommunications Service — dial 700 service. A terminating-user's service that supports interactive voice service between callers at switched-access locations and service provides directly connected to the AT&T Switched Network (ASN).  |
| operator                | Network Operator — provides access to the network operator.   |
| outwats-bnd             | OUTWATS Band — WATS is a voice-grade service providing both voice and low speed data transmission capabilities from the user location to defined service areas referred to as bands; the widest band is 5.  |
| public-ntwrk            | Public network calls — It is the equivalent of CO (outgoing), DID, or DIOD trunk groups. If Service Type is public-ntwrk, Dial Access can be set to <b>y</b> .  |
| sddn                    | Software Defined Data Network — provides a virtual private line connectivity via the AT&T switched network (4ESS switch). Services include voice, data, and video applications. These services complement the SDN service. Do not use for DCS with Rerouting. |
| sdn                     | Software Defined Network (SDN) — an AT&T communications offering that provides a virtual private network using the public switched network. SDN can carry voice and data between customer locations as well as off-net locations.                             |
| sub-operator            | Presubscribed Common Carrier Operator — provides access to the presubscribed common carrier operator.   |
| tandem                  | Tandem tie trunks integral to an ETN — See <a href="#">“Tandem trunk group”</a> .   |
| tie                     | Tie trunks — general purpose — See <a href="#">“Tie trunk group”</a> .  |
| wats-max-bnd            | Maximum Banded Wats — a WATS-like offering for which a user's calls are billed at the highest WATS band subscribed to by users.   |

- **Supplementary Service Protocol** — Indicates which supplementary service protocol to use for services over this trunk group. *Supplementary Service protocols are mutually exclusive.* Enter one of the following. Default is **a**.
  - a National public network/Shared UUI
  - b ISO/ETSI QSIG Private Network
  - c ETSI public network
  - d European Computer Manufacturer's Association (ECMA) QSIG private network (supports only Name Identification and Additional Network Feature Transit Counter (ANF-TC))
  - e DCS with Rerouting
    - Do not use `Service Type` of **dmi-mos** or **sddn** with this option.
    - Set `Used for DCS` (on page 2) to **y**.
- **Test Call BCC** — Indicates the Bearer Capability Code (BCC) used for the ISDN test call. Valid entries and their definitions are as follows:
  - **0** — Voice
  - **1** — Mode 1
  - **2** — Mode 2 Asynchronous
  - **3** — Mode 3 Circuit
  - **4** — Mode 0 (default)
- **Testcall ITC** — Controls the encoding of the Information Transfer Capability (ITC) codepoint of the bearer capability IE in the SETUP message when generating an ISDN test call. Allowed values are **rest** (restricted) and **unr** (unrestricted). Default is **rest**.  
  
 **NOTE:**  
ISDN Testcall feature has no routing, so a testcall is never blocked due to an incompatible ITC.
- **Testcall Service** — Specifies the call-by-call selection for an ISDN-BRI test call. Only appears if `Service Type` is **cbc**. Valid entries are all of the services listed in [Table 7-13](#) excluding **sddn** or any new `Facility Type` of **0** (feature), **1** (service), or **3** (outgoing) that is defined by users on the Network Specific Facility Encoding form.
- **Trunk Hunt** — The switch performs a trunk hunt when searching for available channels within a facility in an ISDN-BRI trunk group.  
  
Enter **cyclical** to enable a circular trunk hunt based on the sequence the trunks were administered within the trunk group.

- **Usage Alloc** — Displays when *Service Type* is **cbc**. Specifies whether users want to allocate the services provided by the trunk group. Valid entries are **y** and **n** (default). If **y** is entered, two additional CBC-related forms display. They are the CBC Trunk Group Usage Allocation Plans form and the CBC Trunk Group Usage Allocation Plan Assignment Schedule.

## Implementation notes

Answer Supervision Timeout defaults to **0**.

Queue Length displays when *Direction* is **outgoing** or **two-way**.

Page 2 of X

```

TRUNK FEATURES
ACA Assignment? n           Measured: none___ Wideband Support? n
Long Holding Time(hours: _   Internal Alert? _       Maintenance Tests? y
Short Holding Time (sec): _   Data Restriction? n   NCA-TSC Trunk Member: 7
Short Holding Threshold: ___   Send Name: n         Send Calling Number: n
    Used for DCS? n           Hop Dgt: _         Send Connected Number: n
    Suppress # Outpulsing? n   Numbering Format: ___   DCS Signaling: ___
Outgoing Channel ID Encoding: _____
Charge Conversion: 1___       UUI IE Treatment: shared
    Decimal Point: none___   Maximum Size of UUI IE Contents: 128
    Currency Symbol: ___
    Charge Type: units___
    Send UCID? n
Send Codeset 6/7 LAI IE? y
    
```

### Screen 7-64. ISDN-BRI Trunk Group form (page 2)

## Fields unique to this form

These fields are unique to the ISDN-BRI trunk group form.

- **DCS Signaling** — Specifies the means used to send the DCS message. This field only displays if *Used for DCS* entry is **y** and *Service Type* is anything except **dmi-mos** or **sddn**. Valid entries are **bx.25** for the traditional DCS feature or **d-chan** for the DCS over ISDN-PRI D-channel feature. Allows you to administer an ISDN trunk group with BRI trunk members unless the DCS Signaling field is d-chan.
- **Hop Dgt** — The Tandem Hop Limitation and QSIG Additional Network Feature Transit Counter (ANF-TC) features provide a counter that reflects the number of switches (that is, the number of hops) that a call has gone through. The counter increments as a call leaves DEFINITY ECS using tandem facilities. Valid values are **y** and **n** (default). One or both of the features can be applied to the trunk group depending on the following:
  - If you enter **y** and *Group Type* is **tandem** or *Group Type* is **isdn** and *Service Type* is **tandem**, the Tandem Hop Limitation feature is applied to the trunk group.

- If you enter **y** and you set `Group Type` to **isdn**, set `Service Type` to **access**, **dmi-mos**, **public-ntwrk**, **tandem**, **tie**, or any of the craft-defined services allowed in the field. Set `Supplementary Service Protocol` to **b** or **d**, then the ANF-TC feature is applied to calls on the trunk group.

 **NOTE:**

The above conditions overlap. If `Group Type` is **isdn**, `Service Type` is **tandem**, and `Supplementary Service Protocol` is **b** or **d**, then both the Tandem Hop Limitation and ANF-TC features are applied to calls on the trunk group.

- If both features are applied to calls on the trunk group, ANF-TC takes precedence. In situations where DEFINITY ECS is an Incoming or Outgoing Gateway, either feature uses the hop count and transit information provided by the other.
- **Maximum Size of UUI IE Contents**—This field appears when the `UUI Treatment` field is set to **shared**. Enter the maximum number of bytes of user information that the network supports. The default is **128**.
- **NCA-TSC Trunk Member** — Identifies the trunk member whose D-channel will be used to route tandem NCA-TSCs. Value range for this field is from **1** to the maximum number of members per trunk group supported on the switch. Default is blank.
- **Numbering Format** — This field appears if `Send Calling Number` is **y** or **r** or `Send Connected Number` is **y** or **r**. This specifies the encoding of the `Numbering Plan Indicator` field for identification purposes in the Calling Number and/or Connected Number IEs, and in the QSIG Party Number. Valid entries are **public** (default), **unknown**, and **private**. **Public** indicates that the number plan according to CCITT Recommendation E.164 is used and that the Type of Number is **national**. **Unknown** indicates the `Numbering Plan Indicator` is **unknown** and the Type of Number is **unknown**. **Private** indicates the `Numbering Plan Indicator` is **PNP** and the Type of Number is determined from the ISDN Private-Numbering form.
- **Outgoing Channel ID Encoding** — Displays only if `Group Type` is **isdn**, `Used for DCS` is **y**, and `Service Type` is anything except **dmi-mos** or **sddn**. Determines whether to encode the Channel ID IE as **preferred** or **exclusive**. Blank is not a valid entry. Defaults are determined as follows:
  - If `Group Type` is **isdn** and `Used for DCS` is **y**, default is **exclusive**.
  - If `Group Type` is **isdn** and `Used for DCS` is **n**, default is **preferred**.
  - If `Group Type` is not **isdn** or it is **isdn**, but `Used for DCS` does not appear, default is **preferred**.
- **Send Calling Number** — Specifies whether the calling party's number is sent on outgoing or tandemed ISDN calls. Valid entries are **y**, **n** (default), or **r** (restricted). If **y** is entered, the ISDN Numbering - Public/Unknown

Format form is accessed to construct the actual number to be sent, or the ISDN Numbering-Private form (based on `Numbering Format`) is used. If `r` is entered, the calling number is sent “presentation restricted.”

 **NOTE:**

The ISDN Numbering - Public/Unknown Format form can override `Send Calling Number` entry for any administrable block of extensions.

- **Send Codeset 6/7 LAI IE?**—Specifies whether the ISDN trunk should transmit information in Codeset 6/7. If the `UUI IE Treatment` field is **shared**, then this field should be **n**. Otherwise, the same information will be sent twice and may exceed the message size. Default is **y** for pre-DEFINITY 6.3 compatibility.
- **Send Connected Number** — Specifies if the connected party’s number is sent on incoming or tandemmed ISDN calls. Valid entries are **y**, **n** (default), or **r** (restricted). If **y** is entered, the ISDN Numbering - Public/Unknown Format form is accessed to construct the actual number sent, or the ISDN Numbering-Private form (based on `Numbering Format`) is used. If the value is **r**, the connected number is sent “presentation restricted.”

 **NOTE:**

The ISDN Numbering - Public/Unknown Format form overrides `Send Connected Number` entry for any administrable block of extensions.

- **Send Name** — Specifies whether the calling/connected/called/busy party’s administered name is sent to the network on outgoing/incoming calls. Valid entries are **y**, **n** (default), or **r** (restricted). The value **r** indicates that the calling/connected name will be sent by the switch but will be marked “presentation restricted.” The value **r** is only valid if `Supplementary Services Protocol` is **b** (for called/busy only) or **d** for the QSIG Global Networking Supplementary Services Protocol. When `Supplementary Service Protocol` is **e** (DCS with Rerouting), only values of **y** and **n** permitted.

 **NOTE:**

If name information is not administered for the calling station or the connected/called/busy station, the system sends the extension number in place of the name.

- **Send UCID**—Specifies whether or not the trunk should transmit Universal Call IDs. The valid entries are **y** and **n** (default).
- **UUI IE Treatment**—Specifies whether the user information is shared. Enter **shared** if the trunk is connected to a DEFINITY 6.3 (or later) switch. Enter **service-provider** (default) if the trunk is connected to a pre-DEFINITY 6.3 switch or service provider functionality is desired.



- **Wideband Support** — Specifies whether or not Wideband Switching is supported by this trunk group. The only valid entry for ISDN-BRI trunk groups is **n** (default).

## Implementation notes

---

Internal Alert only displays if Service Type is **tie**.

DCS Signaling and PBX ID display when Used for DCS is **y**.

The Used for DCS is not displayed if Service Type is **dmi-mos** or **sddn**.

Hop Dgt displays if the Service Type is **tandem**. It also displays when the Supplementary Service Protocol is **b** and the Service Type is **access**, **dmi-mos**, **public-ntwrk**, **tandem**, **tie**, or any Type 0 or Type 1 craft defined service.

Numbering Format displays if Send Calling Number and/or Send Connected Number are **y** or **r**.

## Shared UII Feature Priorities Page

---

This page appears on the trunk group form **only** when the UII IE Treatment field is **shared**. The fields in this page show the priorities for each type of information to be forwarded in the Shared UII.

```
SHARED UII FEATURE PRIORITIES

ASAI: 1

Universal Call ID: 2

MULTI SITE ROUTING (MSR)

    In-VDN Time: 3
    VDN Name: 4
    Collected Digits: 5
    Other LAI Information: 6
```

### Screen 7-65. Shared UII Feature Priorities Page

#### Fields unique to this form

Changing the priorities in this form may affect whether or not certain information will be sent. For more information about setting priorities, see [Information Forwarding](#).

- **ASAI** — User information from ASAI. Valid entries are 1 to 6 and blank. If blank, that field's information is not forwarded.
- **Universal Call ID** — Unique tag to identify each call. Valid entries are 1 to 6 and blank. If blank, that field's information is not forwarded.
- **In-VDN Time** — Number of seconds the call has spent in vector processing. Valid entries are 1 to 6 and blank. If blank, that field's information is not forwarded.
- **VDN Name** — Name of the active VDN (also called LAI DNIS). Valid entries are 1 to 6 and blank. If blank, that field's information is not forwarded.
- **Collected Digits** — Digits collected from caller (not including dial-ahead digits). Valid entries are 1 to 6 and blank. If blank, that field's information is not forwarded.
- **Other LAI Information** — Includes the time stamp of when the call entered the current queue, the call's priority level in its current queue, and the type of interflow. Valid entries are 1 to 6 and blank. If blank, that field's information is not forwarded.

### Incoming Call Handling Treatment Table

| Service/<br>Feature | Called<br>Len | INCOMING CALL HANDLING TREATMENT |     |        | Page y of x        |               |
|---------------------|---------------|----------------------------------|-----|--------|--------------------|---------------|
|                     |               | Called<br>Number                 | Del | Insert | Per Call<br>CPN/BN | Night<br>Serv |
|                     |               |                                  |     |        |                    |               |
|                     |               |                                  |     |        |                    |               |
|                     |               |                                  |     |        |                    |               |
|                     |               |                                  |     |        |                    |               |
|                     |               |                                  |     |        |                    |               |
|                     |               |                                  |     |        |                    |               |
|                     |               |                                  |     |        |                    |               |
|                     |               |                                  |     |        |                    |               |
|                     |               |                                  |     |        |                    |               |
|                     |               |                                  |     |        |                    |               |
|                     |               |                                  |     |        |                    |               |
|                     |               |                                  |     |        |                    |               |
|                     |               |                                  |     |        |                    |               |
|                     |               |                                  |     |        |                    |               |
|                     |               |                                  |     |        |                    |               |
|                     |               |                                  |     |        |                    |               |
|                     |               |                                  |     |        |                    |               |
|                     |               |                                  |     |        |                    |               |
|                     |               |                                  |     |        |                    |               |
|                     |               |                                  |     |        |                    |               |
|                     |               |                                  |     |        |                    |               |

Screen 7-66. Incoming Call Handling Treatment Table form

**NOTE:**  
 This table does not appear if Digit Handling (in/out) is **overlap** on the "in" side or if Direction is **outgoing**.

The Incoming Call Handling Treatment Table can (optionally) provide unique call treatment for different incoming calls on any ISDN-BRI trunk group. The number of unique treatments that can be specified in this table and the number of pages vary depending on whether the Usage Allocation Enhancements feature is enabled and on the amount of available system memory.

Unique digit manipulation capabilities, CPN/BN requests, and night service destinations are possible for different types of incoming calls. The unique digit manipulation capabilities can be particularly useful to accommodate different dial plans for different services on an ISDN-BRI trunk type with a *Service Type* (field entry) of **cbc** (Call-by-Call). The table can also be used for ISDN-BRI trunk groups that are not Call-by-Call. For example, an ISDN-BRI group with *Service Type* set to **mega800** could use the Incoming Call Handling Treatment table to distinguish treatment of calls to different 800 numbers based on the Dialed Number Identification Service (DNIS) number that is incoming to the switch.

Each row in the table consists of seven columns. The first three columns (*Service/Feature*, *Called Len*, and *Called Number*) constitute a key that together select which row or unique treatment should apply for an incoming call on the group. The remaining four columns (*Del*, *Insert*, and so on) specify the treatment to be provided for a call that matches the key.

If an incoming call is for a service listed in a row on the table, then that row may specify the treatment for the call, depending on the other two columns of the key. *Called Len* is used to continue the row determination. If the number of digits received with the incoming call matches the number of digits in *Called Len* for calls to the matched service, then this row may apply. If no other row also contains a matching service and called length, then this row does apply. If another row does exist with the same service and number length, then *Called Number* will be used to continue the row determination.

If the leading digits received with the incoming call match the digits specified in *Called Number*, then this row applies to the call. Therefore, with this table, a unique treatment can be given to any incoming call, even if these calls are to the same service or have the same length of digits. The remaining four fields specify the unique treatment for the call once the row has been determined. Together, the *Del* and *Insert* fields can be used to manipulate the incoming number that will be used to route the call. *Per Call CPN/BN* can be used to request CPN/BN for specific calls incoming on the group. The *Night Serv* field is used to have calls of different types routed to different night destinations when night service is in effect.

 **NOTE:**

DCS features that use the remote-tgs button (on the remote switch) do not work when the local trunk group deletes or inserts digits on the incoming call. These buttons try to dial a local TAC. Adding or deleting digits defeats this operation and renders the remote feature inoperable. If digit manipulation is needed, use it on the outgoing side, based on the routing pattern. One reason for digit manipulation is insertion of the AAR feature access code (FAC).

## Fields unique to this form

These fields are located on the Incoming Call Handling Treatment Table form.

- **Service/Feature** — Specifies the ISDN Services/Features for an incoming call type. See *Service Type* description for a list of predefined Services/Features that can be received. Or, use Type 0, Type 1, and Type 2 user defined services. The identifier “other” can be used for any Services/Features not explicitly specified.
- **Called Len** — Specifies the number of digits received for an incoming call. A blank entry is used as a “wild card” entry and, when used, means that any length of digits associated with the specified Service/Feature can match in this field. Valid entries are **0** to **21**, or leave blank.
- **Called Number** — Specifies the leading digits received for an incoming call. A blank entry is used as a “wild card” entry and, when used, means that any number associated with the specified Service/Feature can match in this field. Valid entries are 1 to 16 digits, or leave blank.
- **Del** — Specifies the number of leading digits to be deleted from the incoming Called Party Number. Calls of a particular type may be administered to be routed to a single destination by deleting all incoming digits and then administering *Insert* with the desired extension. Valid entries are **1** to **21**, **all**, or leave blank.
- **Insert** — Specifies the digits to be prepended to the front of the remaining digits after any (optional) digit deletion has been performed. The resultant number formed from digit deletion/insertion is used to route the call, provided night service is not in effect. Valid entries are up to 16 characters consisting of a combination from the following: 0 through 9, \*, #, or leave blank.
- **Per Call CPN/BN** — Specifies when and how to request Calling Party Number (CPN) or Billing Number (BN) for calls of this type. Leave blank when connected to another switch, or when connected to a public network outside North America. Within North America, leave blank when connected to a public network that does not permit customer equipment to request CPN or BN for individual incoming calls. The AT&T Switched Network offers this service under the titles “CPN/BN to Terminating End on a Per-Call Basis” and “ANI (BN) on Request.” An entry of **none** indicates the switch will not request either CPN or BN for any incoming calls of this type. Valid entries are **cpn-only**, **bn-only**, **bn-pref** (prefer BN, but accepts CPN), **cpn-pref** (prefer CPN, but accepts BN), **none**, or leave blank (default). Leave blank when connected to another switch or to a network other than the AT&T Switched Network.



### NOTE:

A 4-second delay occurs in terminating the call to the far-end station if the connecting switch does not respond to the request.

- **Night Serv** — Specifies a night service extension (can be a VDN extension) per Service/Feature. An entry other than blank overrides *Night Service* entry on page 1 of the form. This entry can be overridden by the Trunk/Member Night Service entry when provided. Valid entries are an assigned extension, the attendant group access code (**attd**), or leave blank.

### Implementation notes

---

When *Service Type* is **cbc**, incoming call handling and digit manipulation are handled on a per *Service/Feature* basis.

For ISDN trunk groups with **cbc** entered in *Service Type*, *Service/Feature* cannot be any of the following: **access**, **dmi-mos**, **public-ntwrk**, **sddn**, **tandem**, or **tie**.

When *Service Type* is not **cbc**, *Service/Feature* must match *Service Type* entered.

### CBC Trunk Group Usage Allocation form

| CBC TRUNK GROUP USAGE ALLOCATION |      |                         |                 |                         |      | Page y of X     |      |      |
|----------------------------------|------|-------------------------|-----------------|-------------------------|------|-----------------|------|------|
| Usage Allocation Plan 1          |      | Usage Allocation Plan 2 |                 | Usage Allocation Plan 3 |      |                 |      |      |
| Min#                             | Max# | Min#                    | Max#            | Min#                    | Max# | Min#            | Max# |      |
| Service/Feature                  | Chan | Chan                    | Service/Feature | Chan                    | Chan | Service/Feature | Chan | Chan |
| _____                            | ___  | ___                     | _____           | ___                     | ___  | _____           | ___  | ___  |
| _____                            | ___  | ___                     | _____           | ___                     | ___  | _____           | ___  | ___  |
| _____                            | ___  | ___                     | _____           | ___                     | ___  | _____           | ___  | ___  |
| _____                            | ___  | ___                     | _____           | ___                     | ___  | _____           | ___  | ___  |
| _____                            | ___  | ___                     | _____           | ___                     | ___  | _____           | ___  | ___  |
| _____                            | ___  | ___                     | _____           | ___                     | ___  | _____           | ___  | ___  |
| _____                            | ___  | ___                     | _____           | ___                     | ___  | _____           | ___  | ___  |
| _____                            | ___  | ___                     | _____           | ___                     | ___  | _____           | ___  | ___  |
| _____                            | ___  | ___                     | _____           | ___                     | ___  | _____           | ___  | ___  |
| _____                            | ___  | ___                     | _____           | ___                     | ___  | _____           | ___  | ___  |
| _____                            | ___  | ___                     | _____           | ___                     | ___  | _____           | ___  | ___  |
| _____                            | ___  | ___                     | _____           | ___                     | ___  | _____           | ___  | ___  |
| _____                            | ___  | ___                     | _____           | ___                     | ___  | _____           | ___  | ___  |
| _____                            | ___  | ___                     | _____           | ___                     | ___  | _____           | ___  | ___  |
| _____                            | ___  | ___                     | _____           | ___                     | ___  | _____           | ___  | ___  |
| _____                            | ___  | ___                     | _____           | ___                     | ___  | _____           | ___  | ___  |
| _____                            | ___  | ___                     | _____           | ___                     | ___  | _____           | ___  | ___  |
| _____                            | ___  | ___                     | _____           | ___                     | ___  | _____           | ___  | ___  |
| _____                            | ___  | ___                     | _____           | ___                     | ___  | _____           | ___  | ___  |
| _____                            | ___  | ___                     | _____           | ___                     | ___  | _____           | ___  | ___  |
| _____                            | ___  | ___                     | _____           | ___                     | ___  | _____           | ___  | ___  |

Screen 7-67. CBC Trunk Group Usage Allocation form

## Fields unique to this form

The CBC Trunk Group Usage Allocation form sets a minimum and maximum number of members for up to ten different Services/Features for up to three different Usage Allocation Plans (1–3).

### NOTE:

See "[Call-by-Call Service Selection](#)" for a detailed description of Usage Allocation Plans.

- **Service/Feature** — Specifies the ISDN Services/Features that can be requested at call setup time when using this trunk group. See *Service Type* description for a list of predefined Services/Features that can be received on a call by call basis. In addition, the user defined service types can also be used. The identifier "other" is used for all Services/Features not explicitly specified.
- **Min# Chan** — Indicates the minimum number of members of an ISDN-BRI trunk group with a *Service Type* of **cbc** that a particular Service/Feature can use at any given time. The sum of the minimum number of members for all Service/Features must not exceed the total number of members of the trunk group. Valid values are **0-99** or blank (default).
- **Max# Chan** — Indicates the maximum number of members of a ISDN-BRI trunk group with a *Service Type* of **cbc** that a particular Service/Feature can use at any given time. This field must be completed if a Service/Feature has been entered in the Incoming Call Handling Treatment Table form. Valid values are **0-99** or blank (default).

## Implementation note

This form displays when *Service Type* is **cbc** and *Usage Alloc* is **y**.

## CBC Service Trunk Group Allocation Plan Assignment Schedule form

Page Y of X

CBC SERVICE TRUNK GROUP ALLOCATION PLAN ASSIGNMENT SCHEDULE

Usage Method:

Fixed? y                      Allocation Plan Number: 1  
 Scheduled? n

Usage Allocation Plan Activation Schedule:

|     | Act<br>Time | Plan<br># | Act<br>Time | Plan<br># | Act<br>Time | Plan<br># | Act<br>Time | Plan<br># | Act<br>Time | Plan<br># |
|-----|-------------|-----------|-------------|-----------|-------------|-----------|-------------|-----------|-------------|-----------|
| Sun | __:         | __        | __:         | __        | __:         | __        | __:         | __        | __:         | __        |
| Mon | __:         | __        | __:         | __        | __:         | __        | __:         | __        | __:         | __        |
| Tue | __:         | __        | __:         | __        | __:         | __        | __:         | __        | __:         | __        |
| Wed | __:         | __        | __:         | __        | __:         | __        | __:         | __        | __:         | __        |
| Thu | __:         | __        | __:         | __        | __:         | __        | __:         | __        | __:         | __        |
| Fri | __:         | __        | __:         | __        | __:         | __        | __:         | __        | __:         | __        |
| Sat | __:         | __        | __:         | __        | __:         | __        | __:         | __        | __:         | __        |

Screen 7-68. CBC Service Trunk Group Allocation Plan Assignment Schedule form

### Fields unique to this form

The CBC Service Trunk Group Allocation Plan Assignment Schedule form provides for administering a fixed schedule or administering a schedule that can change up to six times a day for each day of the week. This form determines which CBC Service Trunk Group Allocation Plan will be in use at any given time.

- **Fixed** — Indicates whether the allocation plan will be fixed. If **y** is entered, the plan number entered in Allocation Plan Number will be enabled. Default is **n**.
- **Allocation Plan Number** — Specifies the CBC Trunk Allocation Plan (1 through 3) that is in effect if a fixed usage method has been selected. This field must be assigned if Fixed is **y**. Valid entries are **1** through **3** or blank (default).
- **Scheduled** — Indicates whether or not the allocation plans will be in effect according to the schedule found on this page. If **y** is entered in this field then there must be at least one entry in the schedule.
- **Act Time** — Indicates the time the usage allocation plan administered in the next field (Plan #) will become effective. Enter the time in military time. There must be at least one entry per day. Valid entries are **00:00** through **23:59**.
- **Plan #** — Specifies the number of the usage allocation plan that will be in effect from the activation time until the activation time of the next scheduled plan change. Valid entries are **1** to **3** or blank (default).

## Implementation notes

This form displays when Service Type is **cbc** and the Usage Alloc is **y**.

Allocation Plan Number only displays if Fixed is **y**.

## Group Member Assignments form

| GROUP MEMBER ASSIGNMENTS |       |       |      |       |       |       |
|--------------------------|-------|-------|------|-------|-------|-------|
| Port                     | Code  | Sfx   | Name | Night | Sig   | Grp   |
| 1:                       | _____ | _____ | -    | _____ | _____ | _____ |
| 2:                       | _____ | _____ | -    | _____ | _____ | _____ |
| 3:                       | _____ | _____ | -    | _____ | _____ | _____ |
| 4:                       | _____ | _____ | -    | _____ | _____ | _____ |
| 5:                       | _____ | _____ | -    | _____ | _____ | _____ |
| 6:                       | _____ | _____ | -    | _____ | _____ | _____ |
| 7:                       | _____ | _____ | -    | _____ | _____ | _____ |
| 8:                       | _____ | _____ | -    | _____ | _____ | _____ |
| 9:                       | _____ | _____ | -    | _____ | _____ | _____ |
| 10:                      | _____ | _____ | -    | _____ | _____ | _____ |
| 11:                      | _____ | _____ | -    | _____ | _____ | _____ |
| 12:                      | _____ | _____ | -    | _____ | _____ | _____ |
| 13:                      | _____ | _____ | -    | _____ | _____ | _____ |
| 14:                      | _____ | _____ | -    | _____ | _____ | _____ |
| 15:                      | _____ | _____ | -    | _____ | _____ | _____ |

Screen 7-69. ISDN-BRI Group Member Assignment form

## Fields unique to this form

These fields are unique to the ISDN-BRI Trunk Group Member Assignment form.

 **NOTE:**

The total number of pages, and the first page of Group Member Assignments, will vary depending on whether the CBC and Wideband Support pages display.

- **Port** — Specifies the B-channel port numbers with B-channel 2 being the port number plus 16. For example, if B-channel 1's port number is 01A1002, then B-channel 2's port number would be 01A1018.
- **Sig Grp** — When an ISDN-BRI trunk port is administered, this field becomes unadministrable.



## ISDN-PRI trunk group

---

This form assigns an Integrated Services Digital Network-Primary Rate Interface (ISDN-PRI) trunk group that supports the ISDN-PRI and Call-by-Call Service Selection features. The trunk group provides end-to-end digital connectivity and supports a wide range of services including voice and non-voice services, to which users have access by a limited set of CCITT-defined, standard multipurpose interfaces. Calls can be processed to a variety of switched nodal services such as MEGACOM telecommunications service, WATS, and ACCUNET digital service and calls destined for different interexchange carriers.

The ISDN-PRI trunk group may also be used to support the Wideband Switching feature. This is intended to work with the H0 (384 Kbps), H11 (1536 Kbps), H12 (1920 Kbps), and NXDS0 (128 to 1984 Kbps) data services, and to support high-speed video conferencing and data applications.

### Administration commands

---

When an ISDN-PRI trunk connects two switches, set the trunk options identically at both ends of the connection, with the exception of Trunk Hunt. It is acceptable for both ends to have `Trunk Hunt` administered as **cyclical**, but if one end is administered as **ascend**, the other end must be administered as **descend**. This helps avoid the possibility of glare conditions.

Use the following commands to administer the ISDN-PRI trunk group form.

| Action  | Object      | Qualifier   |
|---------|-------------|---|
| add     | trunk-group | 1-MAX (or 'next')   |
| change  | trunk-group | 1-MAX or tac X...   |
| display | trunk-group | 1-MAX ['number' X]['to-number' X]['count' N]<br>['tac' assigned TAC]['print' or 'schedule'] |
| list    | trunk-group | ['print' or 'schedule']   |
| remove  | trunk-group | 1-MAX or tac X...   |

### Hardware requirements

---

ISDN-PRI is supported by the TN767 circuit pack (for assignment of a T1 signaling link and up to 24 ISDN-PRI trunk group members), or the TN464C or later circuit pack (for assignment of a T1 or E1 signaling link and up to 24 or 31 ISDN-PRI trunk group members, respectively). The TN2207 circuit pack can also be used with ISDN-PRI.

- For R6si and later configurations and R6vs and later configurations, the D-channel switches through either the TN765 Processor Interface (PI) circuit pack or the TN778 Packet Control (PACCON) circuit pack.

- For R6r and later configurations, the D-channel switches through the TN1655 Packet Interface (PKTINT) circuit pack.
- A TN780 or TN2182 Tone Clock circuit pack is required to provide synchronization for the DS1 circuit pack.



**NOTE:**

The TN767 cannot be used to carry the D-channel if either the TN778 (PACCON) or TN1655 (PKTINT) circuit packs are used to switch the D-channel. However, in these circumstances, the TN767 can be used for NFAS interfaces carrying only B-channels.

**How to administer ISDN-PRI trunk groups**

**Required forms for the TN765 Processor Interface (PI) for R6si and later configurations**

| <b>Form</b>  | <b>Field</b>   | <b>Page</b>           |
|--|--|-----------------------|
| System-Parameters<br>Customer-Options                                      | <ul style="list-style-type: none"> <li>■ Version</li> <li>■ ISDN-PR</li> <li>■ QSIG Optional Features</li> </ul>   | <a href="#">5-277</a> |
| Feature-Related System Parameters  | <ul style="list-style-type: none"> <li>■ Send Non-ISDN Trunk Group Name as Connected Name</li> <li>■ Display Connected Name/Number for ISDN DCS Calls</li> </ul> | <a href="#">5-123</a> |
| DS1 Circuit Pack   | <ul style="list-style-type: none"> <li>■ All</li> </ul>  | <a href="#">7-79</a>  |
| Signaling Group  | <ul style="list-style-type: none"> <li>■ All</li> </ul>  | <a href="#">7-106</a> |
| Synchronization Plan   | <ul style="list-style-type: none"> <li>■ All</li> </ul>  | <a href="#">7-112</a> |
| Data Module  | <ul style="list-style-type: none"> <li>■ All</li> </ul>  | <a href="#">6-230</a> |
| Processor Channel Assignment for R5si and later configuration Installation | <ul style="list-style-type: none"> <li>■ All</li> </ul>  | <a href="#">5-252</a> |
| Interface Links  | <ul style="list-style-type: none"> <li>■ All</li> </ul>  | <a href="#">5-179</a> |
| Trunk Group (ISDN-PRI)   | <ul style="list-style-type: none"> <li>■ All</li> </ul>  | <a href="#">7-219</a> |
| ISDN Numbering - Public/Unknown  | <ul style="list-style-type: none"> <li>■ All</li> </ul>  | <a href="#">7-95</a>  |
| ISDN Numbering - Private   | <ul style="list-style-type: none"> <li>■ All</li> </ul>  | <a href="#">7-93</a>  |

*Continued on next page*

**Required forms for the TN765 Processor Interface (PI) for R6si and later configurations — *Continued***

| <b>Form</b>                 | <b>Field</b>          | <b>Page</b>           |
|-----------------------------|-----------------------|-----------------------|
| Route Pattern               | ■ All                 | <a href="#">8-67</a>  |
| Hunt Groups                 | ■ ISDN Caller Display | <a href="#">5-158</a> |
| Terminating Extension Group | ■ ISDN Caller Display | <a href="#">5-295</a> |

**Required forms for the TN778 Packet Control (PACCON) for R6si and later configurations**

| <b>Form</b>                           | <b>Field</b>  | <b>Page</b>           |
|---------------------------------------|---|-----------------------|
| Feature-Related System Parameters     | <ul style="list-style-type: none"> <li>■ Send Non-ISDN Trunk Group Name as Connected Name?</li> <li>■ Display Connected Name/Number for ISDN DCS Calls?</li> </ul>      | <a href="#">5-123</a> |
| DS1 Circuit Pack                      | ■ All   | <a href="#">7-79</a>  |
| System-Parameters Customer-Options    | <ul style="list-style-type: none"> <li>■ Version</li> <li>■ ISDN-PRI</li> <li>■ ISDN-BRI Trunks</li> <li>■ PRI Over PACCON</li> <li>■ QSIG Optional Features</li> </ul> | <a href="#">5-277</a> |
| Maintenance-Related System Parameters | ■ Packet Bus Maint  | <a href="#">5-212</a> |
| Signaling Group                       | ■ All   | <a href="#">7-106</a> |
| Synchronization Plan                  | ■ All   | <a href="#">7-112</a> |
| Trunk Group (ISDN-PRI)                | ■ All   | <a href="#">7-219</a> |
| ISDN Numbering - Public/Unknown       | ■ All   | <a href="#">7-95</a>  |
| ISDN Numbering - Private              | ■ All   | <a href="#">7-93</a>  |

*Continued on next page*

**Required forms for the TN778 Packet Control (PACCON) for R6si and later configurations — *Continued***

| <b>Form</b>                 | <b>Field</b>          | <b>Page</b>           |
|-----------------------------|-----------------------|-----------------------|
| Route Pattern               | ■ All                 | <a href="#">8-67</a>  |
| Hunt Groups                 | ■ ISDN Caller Display | <a href="#">5-158</a> |
| Terminating Extension Group | ■ ISDN Caller Display | <a href="#">5-295</a> |

**Required forms for R6r and later configurations**

| <b>Form</b>                           | <b>Field</b>   | <b>Page</b>           |
|---------------------------------------|--|-----------------------|
| Feature-Related System Parameters     | <ul style="list-style-type: none"> <li>■ Send Non-ISDN Trunk Group Name as Connected Name?</li> <li>■ Display Connected Name/Number for ISDN DCS Calls?</li> </ul> | <a href="#">5-123</a> |
| System-Parameters<br>Customer-Options | <ul style="list-style-type: none"> <li>■ Version</li> <li>■ ISDN-PRI</li> <li>■ ISDN-Brl Trunks</li> <li>■ QSIG Optional Features</li> </ul>                       | <a href="#">5-277</a> |
| DS1 Circuit Pack                      | ■ All  | <a href="#">7-79</a>  |
| Signaling Group                       | ■ All  | <a href="#">7-106</a> |
| Synchronization Plan                  | ■ All  | <a href="#">7-112</a> |
| Trunk Group (ISDN-PRI)                | ■ All  | <a href="#">7-219</a> |
| ISDN Numbering - Public/Unknown       | ■ All  | <a href="#">7-95</a>  |
| ISDN Numbering - Private              | ■ All  | <a href="#">7-93</a>  |
| Route Pattern                         | ■ All  | <a href="#">8-67</a>  |
| Hunt Groups                           | ■ ISDN Caller Display  | <a href="#">5-158</a> |
| Terminating Extension Group           | ■ ISDN Caller Display  | <a href="#">5-295</a> |

## Notes for the Above Tables

---

- **System-Parameters Customer-Options** — ISDN-PRI should be enabled. For a TN778, set `PRI Over PACCON` to **y**. The `QSIG Optional Features` fields may be enabled to allow appropriate administration for the `Supplementary Service Protocol`.
- **System-Parameters Features** — Set `Send Non-ISDN Trunk Group Name as Connected Name` and `Display Connected Name/Number for ISDN DCS Calls`. (Default is **n**.)
- **DS1 Circuit Pack** —
  - **DS1 (T1) Circuit Pack**

Assign all fields as required. For Facility Associated Signaling, up to 23 ports are available for administration as trunk members in an associated ISDN-PRI trunk group. The 24th port is used as a signaling channel. For Non-Facility Associated Signaling, all 24 ports may be used on certain DS1 circuit packs. The D-channel signaling function for these packs must be provided by a designated DS1 pack on its 24th channel.
  - **E1 Circuit Pack**

Assign all fields as required. For Facility Associated Signaling, up to 30 ports are available for administration as trunk members in an associated ISDN-PRI trunk group. Port number 16 is used as a signaling channel.
- **System-Parameters Maintenance-Options** — Use this form only for a TN778. Set `Packet Bus Maint` to **y**.
- **ISDN-PRI Trunk Group** — Enter information in all the fields except the trunk group members. Enter the members after you establish the signaling links.
- **Signaling Group** — Complete all fields. This form identifies groups of ISDN-PRI DS1 interface B-channels for which a given D-channel (or D-channel pair) will carry the associated signaling information (supports the Facility and Non-Facility Associated Signaling feature). Each DS1 board that is required to have a D-channel must be in a different signaling group by itself (unless D-channel backup is needed, in which case a second DS1 is administered as a backup D-channel). You are not required to select a channel for a trunk group, but if you do, you must have already defined the trunk group as type ISDN.



### NOTE:

The following three forms, Processor Interface Data Module, Communication Interface Links, and Communication Processor Channel Assignment are used only to implement the ISDN-PRI feature using PI TN765.

- Processor Interface Data Module — Use this form only for a TN765. Assign up to 8 interface links using 8 Processor Interface Data Module forms for multi-carrier cabinet systems, and up to 4 links for single-carrier cabinet systems. One Processor Interface Data Module form must be completed for each interface link to be assigned.
- Communication Interface Links — Use this form only for a TN765. Assign link numbers 01 to 08 for a multi-carrier cabinet system or links 01 to 04 for a single-carrier cabinet system as required. When first administering this form in DEFINITY ECS for ISDN, do not administer the Enable field.
- Communication Processor Channel Assignment — Use this form only for a TN765. Enter assigned link numbers and assign associated channel numbers to each link. Complete all fields of the form as required. When first administering this form in DEFINITY ECS for ISDN, you need to:
  - First, administer the Interface Links form, except the Enable field.
  - Second, administer the ISDN fields on the Processor Channel form.
  - Last, go back to the Interface Links form and administer the Enable field.
- ISDN Numbering - Public/Unknown — Complete all fields. This form supports the ISDN-PRI Call Identification Display.
- ISDN Numbering - Private — Complete all fields. This form supports the ISDN-PRI Call Identification Display.
- Routing Pattern — Complete all fields including the Supplemental ISDN Routing Information fields as required.
- Hunt Group — Complete `ISDN Caller Display` by entering either **grp-name** or **mbr-name** to specify whether the hunt group name or member name, respectively, is sent to the originating user (supports the ISDN-PRI Call Identification Display feature).
- Terminating Extension Group — Complete `ISDN Caller Display` by entering either **grp-name** or **mbr-name** to specify whether the group name or member name, respectively, is sent to the originating user (supports the ISDN-PRI Call Identification Display feature).
- Synchronization Plan — Assigns primary and secondary external synchronization sources for the DS1 circuit pack. Complete all form fields as required.

## Design Considerations

ISDN-BRI and ISDN-PRI trunks cannot be mixed in the same trunk group. Therefore, consider the following:

- The earliest trunk member (the lowest numbered one) administered is considered correct.
- If an offending member is subsequently found (meaning the first member was BRI and a later member was PRI, or vice versa), the cursor positions on the offending member, and the following error message appears:

**Cannot mix BRI and PRI ports in the same trunk group.**

## Field descriptions

Many of the fields on the following forms are described in [“Trunk Groups — General” on page 7-115](#). If a field on this form is unique, it is listed and defined.

### ISDN-PRI trunk group form page 1

```

                                                                 Page 1 of X
                                TRUNK GROUP
Group Number: xxx                Group Type: isdn                CDR Reports: y
Group Name: OUTSIDE_CALL_____ COR: 1_                TN: 1_                TAC: ____
Direction: two-way_            Outgoing Display? n
Dial Access? n                Busy Threshold: 99_            Night Service: ____
Queue Length: 0__
Service Type: _____        Auth Code? n                TestCall ITC: rest
Usage Alloc: _____        Far End Test Line No: _____
TestCall BCC: 4                TestCall Service: _____
TRUNK PARAMETERS
    Codeset to Send Display: 6    Codeset to Send TCM,Lookahead: 6
    Max Message Size to Send: 260 Charge Advice: none_____
    Supplementary Service Protocol: a    Digit Handling(in/out):overlap/overlap
    Digit Treatment: insertion        Digits: 1234
    Trunk Hunt: cyclical
    Connected to Toll? n    STT Loss: normal        DTT to DCO Loss: normal
    Calling Number - Delete: ___ Insert: _____    Numbering Format: _____
    Bit Rate: 1200_        Synchronization: async    Duplex: full
    Disconnect Supervision - In? y Out? n
    Answer Supervision Timeout: 0__
```

Screen 7-70. ISDN-PRI Trunk Group form (page 1)

## Fields unique to this form

These fields are unique to the ISDN-PRI trunk group form.

- **Calling Number** — These three fields comprise the administrable fields for the Calling Line Identification Prefix feature. They display when *Direction* is **incoming** or **two-way**.
  - Delete — The number of digits to delete from the calling party number for all incoming calls on this trunk group. Valid values: any number from **1-15**, **all** or blank.
  - Insert — The specific digits prefixed to incoming calls when the calling party is a member of this trunk group. Valid values: any string of 1-15 digits or blank.
  - Numbering Format — Indicates TON/NPI encoding applied to CPN information modified by the CLI Prefix feature. This encoding does not apply to calls originating locally. *Numbering Format* on page two of this form applies to calls originated from this switch.

If this field is blank, DEFINITY ECS passes on the encoding received in the incoming setup message. If the incoming setup message did not contain CPN information, and digits are added, the outgoing message will contain these digits. If *Numbering Format* is blank in this case, the value defaults to **pub-unk**.

If *Numbering Format* on page two of this form is also administered as **unknown**, the trunk group is modified to “unk-unk” encoding of the TON/NPI. Therefore this field also must contain a value other than **unknown**.

**⇒ NOTE:**

The values for this field map to the Type of Numbering (TON) and Numbering Plan Identifier (NPI) values shown in [Table 7-12](#).

**Table 7-12. Numbering Format Valid Values**

| Numbering format valid values | Type of numbering (TON) | Numbering plan identifier (NPI) |
|-------------------------------|-------------------------|---------------------------------|
| blank                         | incoming TON unmodified | incoming NPI unmodified         |
| natl-pub                      | national(2)             | E.164(1)                        |
| intl-pub                      | international(1)        | E.164(1)                        |
| locl-pub                      | local/subscriber(4)     | E.164(1)                        |

*Continued on next page*



Table 7-12. Numbering Format Valid Values — *Continued*

| Numbering format valid values | Type of numbering (TON) | Numbering plan identifier (NPI) |
|-------------------------------|-------------------------|---------------------------------|
| pub-unk                       | unknown(0)              | E.164(1)                        |
| lev0-pvt                      | local(4)                | Private Numbering Plan - PNP(9) |
| lev1-pvt                      | Regional Level 1(2)     | Private Numbering Plan - PNP(9) |
| lev2-pvt                      | Regional Level 2(1)     | Private Numbering Plan - PNP(9) |
| unk-unk                       | unknown(0)              | unknown(0)                      |

- **Charge Advice** — Allows you to accumulate and access charge information about a call. You must have already set `CDR Report` to **y** or **r** (ring-intvl) before changing this field from its default of **none**. You may specify one of the following options:
  - none — No Advice of Charge information is collected by the system.
  - automatic — Advice of Charge is enabled automatically for all outgoing calls over this trunk group.
  - end-on-request — DEFINITY ECS will request information at the end of the call for each outgoing call over this trunk group.
  - during-on-request — DEFINITY ECS will request information during and at the end of the call for each outgoing call over this trunk group.

Remember that requesting “during-on-request” affects system performance because the option increases message activity on the signaling channel which may reduce the maximum call capacity.

- **Codeset to Send Display** — This field defines the codeset for sending the information element for Display. The value depends on the type of switch the user is connected to.
  - 0 — CCITT
  - 6 — Any other than CCITT or System 85 R2V4, 4E11 (default)
  - 7 — System 85 R2V4, 4E11

- **Codeset to Send TCM, Lookahead** — This field defines the codeset for sending the information element for Traveling Class Marks and Lookahead Interflow. The value depends on the type of switch the user is connected to. Valid entries are **7** for System 85 R2V4, 4E11, or newer switch types, or **6** (default) for other types.



**NOTE:**

A Traveling Class Mark (that is, the user's FRL or the user's trunk group FRL) is passed between tandem nodes in an ETN in the setup message only when the `Service Type` is **tandem**. It is then used by the distant tandem switch to permit access to facilities consistent with the originating user's privileges.

- **Digit Handling (in/out)** — This field defines whether overlap receiving and overlap sending features are enabled. Set the field to **overlap** when you want overlap receiving or overlap sending. Set the field to **enbloc** when you do not want these features enabled. The first field value indicates digit receiving and the second value indicates digit sending. There are 4 possible combinations: **enbloc/enbloc** (default), **enbloc/overlap**, **overlap/enbloc**, and **overlap/overlap**.

Without overlap receiving or sending enabled, the digits on incoming and outgoing calls are sent enbloc. If `Digit Handling` is **overlap/enbloc** or **overlap/overlap**, the following results:

- Incoming Call Handling Treatment table does not appear.
  - `Digit Treatment` and `Digits` appear.
  - Warning message indicates that all Incoming Call Handling entries are removed when form is submitted.
  - When form is submitted with these values, all Incoming Call Handling entries are removed.
- **Far End Test Line No.** — Specifies the number sent to the far-end's ISDN test line extension. When the **test trunk long** command is issued, this exact number is sent to the far-end to establish a call that tests the integrity of the trunk member under test. The number does not pass through routing or undergo digit manipulation. The digits entered must be what the far-end expects. For example, for an ISDN tandem trunk, the far-end test number should be a 7-digit ETN (Electronic Tandem Network) number. Up to 15 digits may be entered in this field.

- **Max Message Size to Send** — Defines the maximum size of ISDN-PRI messages sent by the switch. Currently, the system can receive 260 byte messages. Valid entries are **128**, **244**, **256**, and **260** (default). The following table indicates the expected message size from several Lucent Technologies products.

| Products         | Message Length (octets) Received |
|------------------|----------------------------------|
| 4ESS (4E11)      | 256                              |
| 4ESS (4E13)      | 256                              |
| 4ESS (4E14)      | 256                              |
| 5ESS (5E4)       | 244                              |
| 5ESS (5E5)       | 244                              |
| 5ESS (5E6)       | 244                              |
| System 75 (all)  | 260                              |
| System 85 (R2V4) | 128                              |
| System 85 (R2V5) | 260                              |
| System 85 (R2V6) | 260                              |

- **Service Type** — Indicates the service for which this trunk group is dedicated. [Table 7-13](#) provides a listing of predefined entries. In addition to the Services/Features listed in this table, any user-defined Facility Type of Type 0 (feature) or Type 1 (service) on the Network Facilities form is allowed. An entry of **cbc** is also allowed, which indicates this trunk group is used by the Call-By-Call Service Selection feature.

Up to 10 (R6si, R6vs) or 200 (R6r) ISDN-BRI and/or ISDN-PRI trunk groups can have this field administered as **cbc**.

**Table 7-13. Predefined Services/Features — ISDN**

| Administratio<br>n mnemonic | Description  |
|-----------------------------|--|
| access                      | A tie trunk giving access to an Electronic Tandem Network — See <a href="#">“Access trunk group” on page 7-150</a> |
| accunet                     | ACCUNET Switched Digital Service — part of ACI (AT&T Communications ISDN) phase 2.                                 |
| cbc                         | Call-by-Call service — provides different dial plans for different services on an ISDN-PRI trunk group.            |

*Continued on next page*

Table 7-13. Predefined Services/Features — ISDN — *Continued*

| Administratio<br>n mnemonic | Description   |
|-----------------------------|---|
| dmi-mos                     | Digital multiplexed interface — message oriented signaling — See <a href="#">“DMI-BOS trunk group” on page 7-188</a> . Do not use with DCS with Rerouting.  |
| i800                        | International 800 Service — allows a subscriber to receive international calls without a charge to the call originating party.  |
| inwats                      | INWATS — provides OUTWATS-like pricing and service for incoming calls.  |
| lds                         | Long-Distance Service — part of ACI (AT&T Communications ISDN) phase 2.   |
| megacom                     | MEGACOM Service — an AT&T communications service that provides unbanded long-distance services using special access (switch to 4ESS switch) from an AT&T communications node.   |
| mega800                     | MEGACOM 800 Service — an AT&T communications service that provides unbanded 800 service using special access (4ESS switch to switch) from an AT&T communications node.  |
| multiquest                  | AT&T MULTIQUEST Telecommunications Service — dial 700 service. A terminating-user’s service that supports interactive voice service between callers at switched-access locations and service provides directly connected to the AT&T Switched Network (ASN).  |
| operator                    | Network Operator — provides access to the network operator.   |
| outwats-bnd                 | OUTWATS Band — WATS is a voice-grade service providing both voice and low speed data transmission capabilities from the user’s location to defined service areas referred to as bands; the widest band is 5.  |
| public-ntwrk                | Public network calls — It is the equivalent of CO (outgoing), DID, or DIOD trunk groups. If Service Type is public-ntwrk, Dial Access can be set to <b>y</b> .  |
| sddn                        | Software Defined Data Network — provides a virtual private line connectivity via the AT&T switched network (4ESS switch). Services include voice, data, and video applications. These services complement the SDN service. Do not use for DCS with Rerouting. |
| sdn                         | Software Defined Network (SDN) — an AT&T communications offering that provides a virtual private network using the public switched network. SDN can carry voice and data between customer locations as well as off-net locations.                             |

*Continued on next page*

Table 7-13. Predefined Services/Features — ISDN — *Continued*

| Administratio<br>n mnemonic | Description   |
|-----------------------------|---|
| sub-operator                | Presubscribed Common Carrier Operator — provides access to the presubscribed common carrier operator.                           |
| tandem                      | Tandem tie trunks integral to an ETN — See <a href="#">“Tandem trunk group”</a> .   |
| tie                         | Tie trunks — general purpose — See <a href="#">“Tie trunk group”</a> .  |
| wats-max-bnd                | Maximum Banded Wats — a WATS-like offering for which a user's calls are billed at the highest WATS band subscribed to by users. |

- **Supplementary Service Protocol** — Indicates which supplementary service protocol should be used for services over this trunk group. *Supplementary Service protocols are mutually exclusive.* Enter one of the following Supplementary Service Protocols. Default is **a**.
  - a national public network
  - b ISO/ETSI QSIG Private Network
  - c ETSI public network
  - d European Computer Manufacturer's Association (ECMA) QSIG private network (supports only Name Identification and Additional Network Feature Transit Counter (ANF-TC))
  - e DCS with Rerouting
    - Do not use `Service Type` of **dmi-mos** or **sddn** with this option.
    - Set `Used for DCS` (on page 2) to **y**.
- **Test Call BCC** — Indicates the Bearer Capability Code (BCC) used for the ISDN-PRI test call. Valid entries and their definitions are as follows:
  - 0 — Voice
  - 1 — Mode 1
  - 2 — Mode 2 Asynchronous
  - 3 — Mode 3 Circuit
  - 4 — Mode 0 (default)

- **Testcall ITC** — Controls the encoding of the Information Transfer Capability (ITC) codepoint of the bearer capability IE in the SETUP message when generating an ISDN test call. Allowed values are **rest** (restricted) and **unre** (unrestricted); default is **rest**.

 **NOTE:**

ISDN Testcall feature has no routing, so a testcall is never blocked due to an incompatible ITC.

- **Testcall Service** — Specifies the call-by-call selection for an ISDN-PRI test call. Only appears if `Service Type` is **cbc**. Valid entries are all of the services listed in [Table 7-13](#) excluding **sddn** or any new Facility Type of Type 0 (feature), Type 1 (service), or Type 3 (outgoing) that is defined by users on the Network Specific Facility Encoding form.
- **Trunk Hunt** — The switch performs a trunk hunt when searching for available channels within a facility in an ISDN-PRI trunk group. Enter **ascend** to enable a linear trunk hunt search from the lowest to highest numbered channels, or **descend** for a linear trunk hunt search from the highest to lowest numbered channels. With both **ascend** and **descend**, all trunks within an ISDN-PRI trunk group are selected based on this field and without regard to the order in which trunks are administered within the trunk group.

Enter **cyclical** (default) to enable a circular trunk hunt based on the sequence the trunks were administered within the trunk group.

 **NOTE:**

The **cyclical** option cannot be set if the trunk group is to be used for Wideband operations (`wideband Support` set to **y**).

The search can be administered per ISDN-PRI trunk group, but it infers the direction of search within all ISDN-PRI facilities (or portions of those facilities) administered within the trunk group.

- **Usage Alloc** — Displays when `Service Type` is **cbc**. Specifies whether the users want to allocate the services provided by the trunk group. Valid entries are **y** and **n** (default). If **y** is entered, two additional CBC-related forms display. They are the CBC Trunk Group Usage Allocation Plans form and the CBC Trunk Group Usage Allocation Plan Assignment Schedule.

## Implementation notes

`Answer Supervision Timeout` defaults to **0**.

`Digit Treatment` and `Digits` display when `Digit Handling (in/out)` is **overlap** on the “in” side.

Queue Length displays when Direction is **outgoing** or **two-way**.

Usage Alloc and Testcall Service display when Service Type is **cbc**.

## ISDN-PRI trunk group form page 2

Page 2 of X

TRUNK FEATURES

|                                     |                                      |                          |
|-------------------------------------|--------------------------------------|--------------------------|
| ACA Assignment? n                   | Measured: none___                    | Wideband Support? n      |
| Long Holding Time(hours: _          | Internal Alert? _                    | Maintenance Tests? y     |
| Short Holding Time (sec): _         | Data Restriction? n                  | NCA-TSC Trunk Member: 7  |
| Short Holding Threshold: ___        | Send Name: n                         | Send Calling Number: n   |
| Used for DCS? n                     | Hop Dgt: _                           | Send Connected Number: n |
| Suppress # Outpulsing? n            | Numbering Format: _____              | DCS Signaling: ___       |
| Outgoing Channel ID Encoding: _____ |                                      |                          |
| Charge Conversion: 1___             | UII IE Treatment: shared             |                          |
| Decimal Point: none__               | Maximum Size of UII IE Contents: 128 |                          |
| Currency Symbol: ___                |                                      |                          |
| Charge Type: units__                |                                      |                          |
| Send UCID? n                        |                                      |                          |
| Send Codeset 6/7 LAI IE? y          |                                      |                          |

### Screen 7-71. ISDN-PRI Trunk Group form (page 2)

#### Fields unique to this form

These fields are unique to the ISDN-PRI trunk group form.

- **DCS Signaling** — Specifies the means used to send the DCS message. This field only displays if *Used for DCS* entry is **y** and *Service Type* is anything except **dmi-mos** or **sddn**. Valid entries are **bx.25** for the traditional DCS feature or **d-chan** for the DCS over ISDN-PRI D-channel feature.
- **Hop Dgt** — The Tandem Hop Limitation and QSIG Additional Network Feature Transit Counter (ANF-TC) features provide a counter that reflects the number of switches (that is, the number of hops) that a call has gone through. The counter increments as a call leaves DEFINITY ECS using tandem facilities. Valid values are **y** and **n** (default). One or both of the features can be applied to the trunk group depending on the following:
  - If you enter **y** and *Group Type* is **tandem** or *Group Type* is **isdn** and *Service Type* is **tandem**, the Tandem Hop Limitation feature is applied to the trunk group.
  - If you enter **y** and you set *Group Type* to **isdn**, set *Service Type* to **access**, **dmi-mos**, **public-ntwrk**, **tandem**, **tie**, or any of the craft-defined services allowed in the field. Set *Supplementary Service Protocol* to **b** or **d**, then the ANF-TC feature is applied to calls on the trunk group.

⇒ NOTE:

The above conditions overlap. If `Group Type` is **isdn**, `Service Type` is **tandem**, and `Supplementary Service Protocol` is **b** or **d**, then both the Tandem Hop Limitation and ANF-TC features are applied to calls on the trunk group.

— If both features are applied to calls on the trunk group, ANF-TC takes precedence. In situations where DEFINITY ECS is an Incoming or Outgoing Gateway, either feature uses the hop count and transit information provided by the other.

- **Maximum Size of UII IE Contents**—Appears when UII Treatment is shared.
- **NCA-TSC Trunk Member** — Identifies the trunk member whose D-channel will be used to route tandem NCA-TSCs. Value range for this field is from **1** to the maximum number of members per trunk group supported on the switch. Default is blank.
- **Numbering Format** — This field appears if `Send Calling Number` is **y** or **r** or `Send Connected Number` is **y** or **r**. This specifies the encoding of the “Numbering Plan Indicator” field for identification purposes in the Calling Number and/or Connected Number IEs, and in the QSIG Party Number. Valid entries are **public** (default), **unknown**, and **private**. **Public** indicates that the number plan according to CCITT Recommendation E.164 is used and that the `Type of Number` will be **national**. **Unknown** indicates the `Numbering Plan Indicator` is **unknown** and that the `Type of Number` is **unknown**. **Private** indicates the `Numbering Plan Indicator` is **PNP** and the `Type of Number` is determined from the ISDN Private-Numbering form.
- **Outgoing Channel ID Encoding** — Displays only if `Group Type` is **isdn**, `Used for DCS` is **y**, and `Service Type` is anything except **dmi-mos** or **sddn**. Blank is not a valid entry. Defaults are determined as follows:
  - If `Group Type` is **isdn** and `Used for DCS` is **y**, default is **exclusive**.
  - If `Group Type` is **isdn** and `Used for DCS` is **n**, default is **preferred**.
  - If `Group Type` is not **isdn** or it is **isdn**, but `Used for DCS` does not appear, default is **preferred**.
- **Send Calling Number** — Specifies whether the calling party’s number is sent on outgoing or tandemed ISDN calls. Valid entries are **y**, **n** (default), or **r** (restricted). If **y** is entered, the ISDN Numbering - Public/Unknown Format form is accessed to construct the actual number to be sent, or the ISDN Numbering-Private form (based on `Numbering Format`) is used. If the value is **r**, the calling number is sent “presentation restricted.”

⇒ NOTE:

The ISDN Numbering - Public/Unknown Format form can override the `Send Calling Number` entry for any administrable block of extensions.



- **Send Codeset 6/7 LAI IE?**—Specifies whether the ISDN trunk should transmit information in Codeset 6/7. If the `UUI IE Treatment` field is **shared**, then this field should be **n**. Otherwise, the same information will be sent twice and may exceed the message size. Default is **y** for pre-DEFINITY 6.3 compatibility.
- **Send Connected Number** — Specifies if the connected party's number is sent on incoming or tandemmed ISDN calls. Valid entries are **y**, **n** (default), or **r** (restricted). If **y** is entered, the ISDN Numbering - Public/Unknown Format form is accessed to construct the actual number sent, or the ISDN Numbering-Private form (based on `Numbering Format`) is used. If the value is **r**, the connected number is sent "presentation restricted."

 **WARNING:**

*The AT&T Switched Network Protocol does not support restricted displays of connected numbers. Therefore, if you administer the 1a country-protocol/protocol-version combination on the DS1 form, you should not administer Send Connected Number to "r" (restricted) on the ISDN-PRI Trunk Group form, as this causes display problems.*

 **NOTE:**

The ISDN Numbering - Public/Unknown Format form overrides the `Send Connected Number` entry for any administrable block of extensions.

- **Send Name** — Specifies whether the calling/connected/called/busy party's administered name is sent to the network on outgoing/incoming calls. Valid entries are **y**, **n** (default), or **r** (restricted). The value **r** indicates that the calling/connected name will be sent by the switch but will be marked "presentation restricted." The value **r** is only valid if the `Supplementary Services Protocol` is **b** (for called/busy only) or **d** for the QSIG Global Networking Supplementary Services Protocol. When `Supplementary Service Protocol` is **e** (DCS with Rerouting), only values of **y** and **n** permitted.

 **NOTE:**

If name information is not administered for the calling station or the connected/called/busy station, the system sends the extension number in place of the name.

- **Send UCID**—Specifies whether or not the trunk should transmit Universal Call IDs. The valid entries are **y** and **n** (default).
- **UUI IE Treatment**—Specifies whether the Information Element (IE) is shared. Enter **shared** if the trunk is connected to a DEFINITY 6.3 (or later) switch. Enter **service-provider** (default) if the trunk is connected to a pre-DEFINITY 6.3 switch or service provider functionality is desired.

- **Wideband Support** — Specifies whether or not Wideband Switching is supported by this trunk group. Valid entries are **y** or **n** (default). You can administer this field only if `Wideband Switching` is enabled on the System-Parameters Customer-Options form. If set to **y**, the Wideband Support Options page displays. All trunk members must be from TN464C (or later) circuit packs.



**NOTE:**

Wideband trunk calls are treated as a single trunk call when Automatic Circuit Assurance (ACA) measurements are taken. This way, if an ACA referral call is generated (for short or long holding time), the wideband call only triggers a single referral call using the lowest B-channel trunk member associated with the wideband channel.

## Implementation notes

Internal Alert only displays if Service Type is **tie**.

DCS Signaling and PBX ID display when Used for DCS is **y**.

Used for DCS does not display if Service Type is **dmi-mos** or **sddn**. Set value to **y** to use with DCS with Rerouting

Hop Dgt displays if Service Type is **tandem**. It also displays when Supplementary Service Protocol is **b** and Service Type is **access**, **dmi-mos**, **public-ntwrk**, **tandem**, **tie**, or any Type 0 or Type 1 craft defined service.

## Shared UUI Feature Priorities Page

This page appears on the trunk group form **only** when the UUI IE Treatment field is **shared**. The fields in this page show the priorities for each type of information to be forwarded in the Shared UUI.

SHARED UI FEATURE PRIORITIES

ASAI: 1

Universal Call ID: 2

MULTI SITE ROUTING (MSR)

In-VDN Time: 3

VDN Name: 4

Collected Digits: 5

Other LAI Information: 6

## Screen 7-72. Shared UI Feature Priorities Page

### Fields unique to this form

Changing the priorities in this form may affect whether or not certain information will be sent. For more information about setting priorities, see [Information Forwarding](#).

- **ASAI** — User information from ASAI. Valid entries are **1** to **6** and blank. If blank, that field's information is not forwarded.
- **Universal Call ID** — Unique tag to identify each call. Valid entries are **1** to **6** and blank. If blank, that field's information is not forwarded.
- **In-VDN Time** — Number of seconds the call has spent in vector processing. Valid entries are **1** to **6** and blank. If blank, that field's information is not forwarded.
- **VDN Name** — Name of the active VDN (also called LAI DNIS). Valid entries are **1** to **6** and blank. If blank, that field's information is not forwarded.
- **Collected Digits** — Digits collected from caller (not including dial-ahead digits). Valid entries are **1** to **6** and blank. If blank, that field's information is not forwarded.
- **Other LAI Information** — Includes the time stamp of when the call entered the current queue, the call's priority level in its current queue, and the type of interflow. Valid entries are **1** to **6** and blank. If blank, that field's information is not forwarded.

### Incoming Call Handling Treatment Table

| Service/<br>Feature | Called<br>Len | INCOMING CALL HANDLING TREATMENT |            | Per Call<br>CPN/BN | Night<br>Serv |
|---------------------|---------------|----------------------------------|------------|--------------------|---------------|
|                     |               | Called<br>Number                 | Del Insert |                    |               |
| _____               | _____         | _____                            | _____      | _____              | _____         |
| _____               | _____         | _____                            | _____      | _____              | _____         |
| _____               | _____         | _____                            | _____      | _____              | _____         |
| _____               | _____         | _____                            | _____      | _____              | _____         |
| _____               | _____         | _____                            | _____      | _____              | _____         |
| _____               | _____         | _____                            | _____      | _____              | _____         |
| _____               | _____         | _____                            | _____      | _____              | _____         |
| _____               | _____         | _____                            | _____      | _____              | _____         |
| _____               | _____         | _____                            | _____      | _____              | _____         |
| _____               | _____         | _____                            | _____      | _____              | _____         |
| _____               | _____         | _____                            | _____      | _____              | _____         |
| _____               | _____         | _____                            | _____      | _____              | _____         |
| _____               | _____         | _____                            | _____      | _____              | _____         |
| _____               | _____         | _____                            | _____      | _____              | _____         |
| _____               | _____         | _____                            | _____      | _____              | _____         |
| _____               | _____         | _____                            | _____      | _____              | _____         |
| _____               | _____         | _____                            | _____      | _____              | _____         |
| _____               | _____         | _____                            | _____      | _____              | _____         |
| _____               | _____         | _____                            | _____      | _____              | _____         |

Screen 7-73. Incoming Call Handling Treatment Table form

**⇒ NOTE:**

This table does not appear if Digit Handling (in/out) is **overlap** on the “in” side or if Direction is **outgoing**.

The Incoming Call Handling Treatment Table can (optionally) provide unique call treatment for different incoming calls on any ISDN-PRI trunk group. The number of unique treatments that can be specified in this table and the number of pages vary depending on whether the Usage Allocation Enhancements feature is enabled and on the amount of available system memory.

Unique digit manipulation capabilities, CPN/BN requests, and night service destinations are possible for different types of incoming calls. The unique digit manipulation capabilities can be particularly useful to accommodate different dial plans for different services on an ISDN-PRI trunk type with a Service Type (field entry) of **cbc** (Call-by-Call). The table can also be used for ISDN-PRI trunk groups that are not Call-by-Call. For example, an ISDN-PRI group with Service Type set to **mega800** could use the Incoming Call Handling Treatment table to distinguish treatment of calls to different 800 numbers based on the Dialed Number Identification Service (DNIS) number that is incoming to the switch.

Each row in the table consists of seven columns. The first three columns (Service/Feature, Called Len, and Called Number) constitute a key that together select which row or unique treatment should apply for an incoming call on the group. The remaining four columns (Del, Insert, and so on) specify the treatment to be provided for a call that matches the key.

If an incoming call is for a service listed in a row on the table, then that row may specify the treatment for the call, depending on the other two columns of the key. `Called Len` is used to continue the row determination. If the number of digits received with the incoming call matches the number of digits in `Called Len` for calls to the matched service, then this row may apply. If no other row also contains a matching service and called length, then this row does apply. If another row does exist with the same service and number length, then `Called Number` will be used to continue the row determination.

If the leading digits received with the incoming call match the digits specified in `Called Number`, then this row applies to the call. Therefore, with this table, a unique treatment can be given to any incoming call, even if these calls are to the same service or have the same length of digits. The remaining four fields specify the unique treatment for the call once the row has been determined. Together, the `Del` and `Insert` fields can be used to manipulate the incoming number that will be used to route the call. `Per Call CPN/BN` can be used to request CPN/BN for specific calls incoming on the group. `Night Serv` is used to have calls of different types routed to different night destinations when night service is in effect.

#### ⇒ NOTE:

DCS features that use the remote-tgs button (on the remote switch) do not work when the local trunk group deletes or inserts digits on the incoming call. These buttons try to dial a local TAC. Adding or deleting digits defeats this operation and renders the remote feature inoperable. If digit manipulation is needed, use it on the outgoing side, based on the routing pattern. One reason for digit manipulation is insertion of the AAR feature access code (FAC).

### Fields unique to this form

These fields are located on the Incoming Call Handling Treatment Table form.

- **Service/Feature** — Specifies the ISDN Services/Features for an incoming call type. See the `Service Type` field description for a list of predefined Services/Features that can be received. Or, use Type 0, Type 1, and Type 2 user defined services. The identifier "other" can be used for any Services/Features not explicitly specified.
- **Called Len** — Specifies the number of digits received for an incoming call. A blank entry is used as a "wild card" entry and, when used, means that any length of digits associated with the specified Service/Feature can match in this field. Valid entries are **0** to **21**, or leave blank.
- **Called Number** — Specifies the leading digits received for an incoming call. A blank entry is used as a "wild card" entry and, when used, means that any number associated with the specified Service/Feature can match in this field. Valid entries are 1 to 16 digits, or leave blank.

- **Del** — Specifies the number of leading digits to be deleted from the incoming Called Party Number. Calls of a particular type may be administered to be routed to a single destination by deleting all incoming digits and then administering the Insert field with the desired extension. Valid entries are **1** to **21**, **all**, or leave blank.
- **Insert** — Specifies the digits to be prepended to the front of the remaining digits after any (optional) digit deletion has been performed. The resultant number formed from digit deletion/insertion is used to route the call, provided night service is not in effect. Valid entries are up to 16 characters consisting of a combination from the following: **0** through **9**, **\***, **#**, or leave blank.
- **Per Call CPN/BN** — Specifies when and how to request Calling Party Number (CPN) or Billing Number (BN) for calls of this type. Leave blank when connected to another switch, or when connected to a public network outside North America. Within North America, leave blank when connected to a public network that does not permit customer equipment to request CPN or BN for individual incoming calls. The AT&T Switched Network offers this service under the titles “CPN/BN to Terminating End on a Per-Call Basis” and “ANI (BN) on Request.” An entry of **none** indicates the switch will not request either CPN or BN for any incoming calls of this type. Valid entries are **cpn-only**, **bn-only**, **bn-pref** (prefer BN, but accepts CPN), **cpn-pref** (prefer CPN, but accepts BN), **none**, or leave blank (default). Leave blank when connected to another switch or to a network other than the AT&T Switched Network.

 **NOTE:**

A 4-second delay occurs in terminating the call to the far-end station if the connecting switch does not respond to the request.

- **Night Serv** — Specifies a night service extension (can be a VDN extension) per Service/Feature. An entry other than blank overrides the `Night Service` entry on page 1 of the form. This entry can be overridden by the Trunk/Member Night Service entry when provided. Valid entries are an assigned extension, the attendant group access code (**attd**), or leave blank.

## Implementation notes

---

When `Service Type` is **cbc**, incoming call handling and digit manipulation are handled on a per Service/Feature basis.

For ISDN trunk groups with **cbc** entered in `Service Type`, `Service/Feature` cannot be any of the following: **access**, **dmi-mos**, **public-ntwrk**, **sddn**, **tandem**, or **tie**.

When `Service Type` is not **cbc**, `Service/Feature` must match the `Service Type` field entered.

### CBC Trunk Group Usage Allocation form

| CBC TRUNK GROUP USAGE ALLOCATION |      |      |                         |      |      | Page y of X             |      |      |
|----------------------------------|------|------|-------------------------|------|------|-------------------------|------|------|
| Usage Allocation Plan 1          |      |      | Usage Allocation Plan 2 |      |      | Usage Allocation Plan 3 |      |      |
| Service/Feature                  | Min# | Max# | Service/Feature         | Min# | Max# | Service/Feature         | Min# | Max# |
|                                  | Chan | Chan |                         | Chan | Chan |                         | Chan | Chan |
|                                  |      |      |                         |      |      |                         |      |      |
|                                  |      |      |                         |      |      |                         |      |      |
|                                  |      |      |                         |      |      |                         |      |      |
|                                  |      |      |                         |      |      |                         |      |      |
|                                  |      |      |                         |      |      |                         |      |      |
|                                  |      |      |                         |      |      |                         |      |      |
|                                  |      |      |                         |      |      |                         |      |      |
|                                  |      |      |                         |      |      |                         |      |      |
|                                  |      |      |                         |      |      |                         |      |      |
|                                  |      |      |                         |      |      |                         |      |      |
|                                  |      |      |                         |      |      |                         |      |      |
|                                  |      |      |                         |      |      |                         |      |      |
|                                  |      |      |                         |      |      |                         |      |      |
|                                  |      |      |                         |      |      |                         |      |      |
|                                  |      |      |                         |      |      |                         |      |      |
|                                  |      |      |                         |      |      |                         |      |      |
|                                  |      |      |                         |      |      |                         |      |      |
|                                  |      |      |                         |      |      |                         |      |      |
|                                  |      |      |                         |      |      |                         |      |      |

Screen 7-74. CBC Trunk Group Usage Allocation form

#### Fields unique to this form

The CBC Trunk Group Usage Allocation form sets a minimum and maximum number of members for up to ten different Services/Features for up to three different Usage Allocation Plans (1–3).

 **NOTE:**  
 See [“Call-by-Call Service Selection”](#) for a detailed description of Usage Allocation Plans.

- **Service/Feature** — Specifies the ISDN Services/Features that can be requested at call setup time when using this trunk group. See the `Service Type` field description for a list of predefined Services/Features that can be received on a call by call basis. In addition, the user defined service types can also be used. The identifier “other” is used for all Services/Features not explicitly specified.
- **Min# Chan** — Indicates the minimum number of members of an ISDN-PRI trunk group with a `Service Type` of **cbc** that a particular Service/Feature can use at any given time. The sum of the minimum number of members for all Service/Features must not exceed the total number of members of the trunk group. Valid values are **0-99** or blank (default).
- **Max# Chan** — Indicates the maximum number of members of a ISDN-PRI trunk group with a `Service Type` of **cbc** that a particular Service/Feature can use at any given time. This field must be completed if a Service/Feature has been entered in the Incoming Call Handling Treatment Table form. Valid values are **0-99** or blank (default).

**Implementation note**

This form displays when Service Type is **cbc** and Usage Alloc is **y**.

**CBC Service Trunk Group Allocation Plan Assignment Schedule form**

Page Y of X

CBC SERVICE TRUNK GROUP ALLOCATION PLAN ASSIGNMENT SCHEDULE

Usage Method:

Fixed? y            Allocation Plan Number: 1  
 Scheduled? n

Usage Allocation Plan Activation Schedule:

|     | Act<br>Time | Plan<br># | Act<br>Time | Plan<br># | Act<br>Time | Plan<br># | Act<br>Time | Plan<br># | Act<br>Time | Plan<br># |   |   |
|-----|-------------|-----------|-------------|-----------|-------------|-----------|-------------|-----------|-------------|-----------|---|---|
| Sun | —           | :         | —           | —         | —           | :         | —           | —         | —           | :         | — | — |
| Mon | —           | :         | —           | —         | —           | :         | —           | —         | —           | :         | — | — |
| Tue | —           | :         | —           | —         | —           | :         | —           | —         | —           | :         | — | — |
| Wed | —           | :         | —           | —         | —           | :         | —           | —         | —           | :         | — | — |
| Thu | —           | :         | —           | —         | —           | :         | —           | —         | —           | :         | — | — |
| Fri | —           | :         | —           | —         | —           | :         | —           | —         | —           | :         | — | — |
| Sat | —           | :         | —           | —         | —           | :         | —           | —         | —           | :         | — | — |

Screen 7-75. CBC Service Trunk Group Allocation Plan Assignment Schedule form

**Fields unique to this form**

The CBC Service Trunk Group Allocation Plan Assignment Schedule form provides for administering a fixed schedule or administering a schedule that can change up to six times a day for each day of the week. This form determines which CBC Service Trunk Group Allocation Plan will be in use at any given time.

- **Fixed** — Indicates whether the allocation plan will be fixed. If **y** is entered in this field, the plan number entered in Allocation Plan Number will be enabled. Default is **n**.
- **Allocation Plan Number** — Specifies the CBC Trunk Allocation Plan (1 through 3) that is in effect if a fixed usage method has been selected. This field must be assigned if Fixed is **y**. Valid entries are **1** through **3** or blank (default).
- **Scheduled** — Indicates whether or not the allocation plans will be in effect according to the schedule found on this page. If **y** is entered in this field then there must be at least one entry in the schedule.



- **Act Time** — Indicates the time the usage allocation plan administered in the next field (Plan #) will become effective. Enter the time in military time. There must be at least one entry per day. Valid entries are **00:00** through **23:59**.
- **Plan #** — Specifies the number of the usage allocation plan that will be in effect from the activation time until the activation time of the next scheduled plan change. Valid entries are **1** to **3** or blank (default).

## Implementation notes

---

This form displays when `Service Type` is **cbc** and the `Usage Alloc` is **y**.

`Allocation Plan Number` only displays if `Fixed` is **y**.

## Wideband Support Options form

```
Wideband Support Options                                     Page Y of X
H0? n
H11? n
H12? n
NxDS0? y           Contiguous? n
```

### Screen 7-76. Wideband Support Options form

## Fields unique to this form

---

The Wideband Support Options form appears immediately before the trunk group member pages. The actual page number will vary.

### ⇒ NOTE:

All B-channels that comprise the wideband call must reside on the same ISDN-PRI facility. Also, all trunk members in an ISDN-PRI trunk group with `Wideband Support` set to **y** must be from a TN464C (or later) circuit pack.

- **H0** — Enter **y** to specify the ISDN information transfer rate for 384-kbps of data, which is comprised of six B-channels. When a trunk group is administered to support H0, the trunk/hunt algorithm to satisfy a call requiring 384-kbps of bandwidth uses a fixed allocation scheme. Default is **n**.

- **H11** — Enter **y** to specify the ISDN information transfer rate for 1536-kbps of data, which is comprised of 24 B-channels. When a trunk group is administered to support H11, the trunk/hunt algorithm to satisfy a call requiring 1536-kbps bandwidth uses a fixed allocation scheme. Default is **n**.
- **H12** — Enter **y** to specify the ISDN information transfer rate for 1920-kbps of data, which is comprised of 30 B-channels. When a trunk group is administered to support H12, the trunk/hunt algorithm to satisfy a call requiring 1920-kbps bandwidth uses a fixed allocation scheme. Default is **n**.
- **NxDS0** — Enter **y** to specify the “N by DS-zero” multi-rate service. Default is **n**.
- **Contiguous?** — Specifies whether or not to hunt contiguous NXDS0 channels. This field only appears if **NXDS0** is **y**.

The trunk/hunt algorithm to satisfy an **NXDS0** call is as follows:

- Enter **y** to specify the “floating” scheme. **NXDS0** calls are placed on a contiguous group of B-channels large enough to satisfy the requested bandwidth without constraint on the starting channel (no fixed starting point trunk).

 **NOTE:**

H0 and **NXDS0** “floating” scheme cannot both be **y**.

- Enter **n** to specify the “flexible” scheme. **NXDS0** calls are placed on any set of B-channels on the same facility as long as the requested bandwidth is satisfied. There are no constraints such as contiguity of B-channels or fixed starting points.

## Implementation notes

This form displays when the `Wideband Support` is **y**.

`Contiguous` only displays if **NXDS0** is **y**.

## Group Member Assignments form

| GROUP MEMBER ASSIGNMENTS |       |       | TRUNK GROUP |  | Page Y of X |       |
|--------------------------|-------|-------|-------------|--|-------------|-------|
|                          |       |       |             | Administered Members(min/max): xxx/yyy |             |       |
|                          |       |       |             | Total Administered Members: xxx        |             |       |
| Port                     | Code  | Sfx   | Name        | Night                                  | Sig Grp     |       |
| 1:                       | _____ | _____ | -           | _____                                  | _____       | _____ |
| 2:                       | _____ | _____ | -           | _____                                  | _____       | _____ |
| 3:                       | _____ | _____ | -           | _____                                  | _____       | _____ |
| 4:                       | _____ | _____ | -           | _____                                  | _____       | _____ |
| 5:                       | _____ | _____ | -           | _____                                  | _____       | _____ |
| 6:                       | _____ | _____ | -           | _____                                  | _____       | _____ |
| 7:                       | _____ | _____ | -           | _____                                  | _____       | _____ |
| 8:                       | _____ | _____ | -           | _____                                  | _____       | _____ |
| 9:                       | _____ | _____ | -           | _____                                  | _____       | _____ |
| 10:                      | _____ | _____ | -           | _____                                  | _____       | _____ |
| 11:                      | _____ | _____ | -           | _____                                  | _____       | _____ |
| 12:                      | _____ | _____ | -           | _____                                  | _____       | _____ |
| 13:                      | _____ | _____ | -           | _____                                  | _____       | _____ |
| 14:                      | _____ | _____ | -           | _____                                  | _____       | _____ |
| 15:                      | _____ | _____ | -           | _____                                  | _____       | _____ |

Screen 7-77. ISDN-PRI Group Member Assignment form

### Fields unique to this form

This field is unique to the ISDN-PRI Trunk Group Member Assignment form.

**⇒ NOTE:**

When supporting DCS, Member Number Assignments must be the same between nodes (Member #1 must be Member #1 at the far-end trunk group).

For BX.25 signaling, Trunk Group numbers must be the same between nodes (trunk group 1 must be trunk group 1 at the far-end).

The trunk access code (TAC) must be less than four digits.

The total number of pages, and the first page of Group Member Assignments, will vary depending on whether the CBC and Wideband Support pages display.

- Sig Grp** — Enter the appropriate signaling group number. If a DS1 interface appears in one signaling group, then the number of that signaling group appears as a default in the Sig Grp column for any trunk on that interface after the form is submitted. This value cannot be altered without adding a DS1 interface to another signaling group. If a DS1 circuit pack appears in more than one signaling group, then Sig Grp cannot be left blank. One of the signaling group members must be entered. Valid values are 1-0 or 1-166 depending on the amount of system memory. Default is blank.

## PCOL trunk group

---

The Personal Central Office Line (PCOL) Trunk Group form provides a dedicated trunk circuit between multiappearance voice terminals and a CO or other switch via the network.

Each PCOL can have an appearance at multiple multiappearance voice terminals. Users assigned this feature press the PCOL feature button to answer and place calls — dial access is not provided. The status lamp associated with the PCOL button indicates the busy or idle status of the trunk. PCOLs are not assigned a COR.

An incoming PCOL call rings all voice terminals assigned the feature (ringing can be either audible or silent, depending on administration). The PCOL button status lamp flashes even if all call appearances at the voice terminal are active. If a call appearance is idle, the status lamp associated with that appearance also flashes.

CO, FX, and WATS trunks can be assigned as PCOLs.

### Administration commands

---

Use the following commands to administer the PCOL trunk group form.

| Action  | Object           | Qualifier <sup>1</sup>  |
|---------|------------------|---|
| add     | personal-co-line | 1—MAX (or 'next')   |
| change  | personal-co-line | 1—MAX   |
| display | personal-co-line | 1—MAX ['number' X]['to-number' X]['count' N]<br>['tac' assigned TAC]['print' or 'schedule'] 1—<br>MAX (or 'next') |
| list    | personal-co-line | ['print' or 'schedule']   |
| remove  | personal-co-line | 1—MAX   |

1. Brackets [ ] indicate the qualifier is optional. Single quotes ( ' ') indicate the text inside the quote must be entered exactly as shown or an abbreviated form of the word may be entered. MAX is the maximum number available in your system configuration.

### Hardware requirements

Requires a port on a TN747B Central Office Trunk circuit pack for each CO, FX, or WATS trunk assigned as a PCOL.

## How to administer PCOL trunk groups

### Required forms

| Form                               | Field   | Page                  |
|------------------------------------|---|-----------------------|
| Personal Central Office Line Group | ■ All   | <a href="#">7-168</a> |
| Station (multiappearance)          | ■ Button/Feature Button Assignments<br>— per-COline (Grp: __)<br>— aut-msg-wt (Ext: ____) | <a href="#">6-14</a>  |

- Personal Central Office Line Group (PCOLG) — Verify or complete all fields.
- Station — Assign (per CO line) buttons to voice terminals in group. If Leave Word Calling (LWC) messages are to be stored for the PCOLG, assign a LWC Remote Message Waiting (aut-msg-wt) feature button with status lamp to one of the voice terminals in the group.

### Field descriptions

The fields on the following forms are described in [“Trunk Groups — General” on page 7-115](#).

### **PCOL trunk group form page 1**

Page 1 of X

```

PERSONAL CO LINE GROUP
Group Number: 1                Group Type: co                CDR Reports: y
Group Name: OUTSIDE CALL      Coverage Path: ____          TAC: ____
Security Code: ____          Outgoing Display? n         Data Restriction? n

TRUNK PARAMETERS
Trunk Type: _____        Trunk Direction: two-way
Trunk Port: _____        Disconnect Timing(msec): 500
Trunk Name: _____        Trunk Termination: _____
Outgoing Dial Type: tone      Terminal Balanced? n
Prefix-1? y RA                Trunk Loss: 0dB
Disconnect Supervision - In? y Call Still Held? n
Answer Supervision Timeout: __ Receive Answer Supervision? _
Trunk Gain: high              Country: 1
Charge Conversion: 1____
Decimal Point: none__
Currency Symbol: ____
Charge Type: units__
    
```

## Fields unique to this form

The following field is unique to the PCOL trunk group form.

- **Coverage Path** — Enter the number of the Call Coverage Path used to redirect the incoming calls on this PCOL Group. This field may be blank.
- **Security Code** — Enter a 4-digit code (or leave blank) that users must dial to retrieve voice messages and to use the Demand Print Message feature.
- **Data Restriction** — Is used to restrict DEFINITY ECS features from causing overriding tones on a PCOL. This provides permanent protection. Valid entries are **y** or **n** (default).
- **Trunk Direction** — Identifies the direction of the trunks in the PCOL Group. Valid entries are **incoming**, **outgoing**, or **two-way** (default) for CO and FX group types. For WATS Group Types, only **incoming** or **outgoing** may be entered.
- **Trunk Port** — Enter seven characters. The first two characters identify the cabinet (01 to 44 [R5r and later configurations], 1 to 3 [R5si and later configurations]); the third character identifies the carrier (A through E); the fourth and fifth identify the slot number in the carrier (01 to 20); the last two characters identify the circuit number (01 to 31).
- **Trunk Name** — A 10-character name that identifies the PCOL group.

## Implementation notes

Call Still Held displays when Group Type is **co**, **fx**, or **wats**.

RA Trunk Loss only displays when Terminal Balanced is **n**.

Disconnect Supervision In only displays when Direction is **incoming**, **outgoing**, or **two-way**.

Outgoing Disconnect and Incoming Disconnect display when Trunk Type is **loop-start** or **ground-start** and Direction is **two-way** or **outgoing**.

Prefix-1 and Call Still Held only display when Group Type is **co** or **fx**.

## PCOL trunk group form page 2

Page 2 of X

### PERSONAL CO LINE GROUP

ASSIGNED MEMBERS (Stations with a button for this PCOL Group)

| Ext | Name | Ext | Name |
|-----|------|-----|------|
| 1:  |      | 9:  |      |
| 2:  |      | 10: |      |
| 3:  |      | 11: |      |
| 4:  |      | 12: |      |
| 5:  |      | 13: |      |
| 6:  |      | 14: |      |
| 7:  |      | 15: |      |
| 8:  |      | 16: |      |

## Screen 7-79. PCOL Trunk Group form (page 2)

### Implementation note

---

This is a display-only form. The PCOL trunk groups are assigned on the Station form. The number of fields displayed varies depending on the DEFINITY ECS configuration and the amount of system memory available.

## Administrable Timers form

Page Y of X

### ADMINISTRABLE TIMERS

|                                   |  |
|-----------------------------------|--|
| Incoming Glare Guard(msec): 1500  | Outgoing Dial Guard(msec): 160             |
|                                   | Outgoing Glare Guard(msec): 1500           |
|                                   | Outgoing Rotary Dial Interdigit(msec): 800 |
| Ringling Monitor(msec): 5200      | Incoming Seizure(msec): 500                |
| Outgoing End of Dial(sec): 10     | Outgoing Seizure Response(sec): 5          |
| Programmed Dial Pause(msec): 1500 |  |
| Flash Length(msec): 540           |  |

### END TO END SIGNALING

|                 |                  |
|-----------------|------------------|
| Tone(msec): 350 | Pause(msec): 150 |
|-----------------|------------------|

### OUTPULSING INFORMATION

|         |                |                 |         |                   |
|---------|----------------|-----------------|---------|-------------------|
| PPS: 10 | Make(msec): 40 | Break(msec): 60 | PPM?: y | Frequency: 50/12k |
|---------|----------------|-----------------|---------|-------------------|

## Screen 7-80. PCOL Trunk Group Administrable Timers form

## Implementation notes

---

PPM only displays when CDR Reports is **y**.

Incoming Disconnect only displays when Trunk Type is **ground-start** or **loop-start** and Direction is **incoming** or **two-way**.

Outgoing Disconnect only displays when Trunk Type is **ground-start** or **loop-start** and Direction is **outgoing** or **two-way**.

Outgoing Glare Guard and Outgoing End of Dial only display when Direction is **outgoing** or **two-way**.

## Considerations

---

The following features cannot be used with the PCOL feature: ARS, Call Forwarding All Calls, and Ringback Queuing.

## Interactions

---

- Abbreviated Dialing  
Abbreviated Dialing can be used with the PCOL feature. However, the accessed lists are associated with the individual voice terminals.
- Auto Hold  
Auto Hold does not work between PCOL calls.
- Bridged Call Appearance  
If a user is active on his or her primary extension number on a PCOL call, bridged call appearances of that extension number cannot be used to bridge onto the call. The call can only be bridged onto if another voice terminal is a member of the same PCOL group and has a PCOL button.
- Call Coverage  
AUDIX cannot be in the coverage path of a PCOL group.
- Hold  
When a user, active on a PCOL call, puts the call on Hold, the status lamp associated with the PCOL button does not track the busy/idle status of the PCOL.
- LWC  
LWC cannot be used with a PCOL call.



- Call Detail Recording

CDR can be activated for PCOL calls, but the CDR record does not specifically identify the call as PCOL. A PCOL call can, however, be identified by the trunk access code used on the call. The call is recorded to the extension number assigned to the voice terminal where the call was originated or answered.

- Send All Calls

Send All Calls cannot be activated for a PCOL group.

- Temporary Bridged Appearance

When a PCOL is shared (assigned to a group), any group member can bridge onto a PCOL call through the Temporary Bridged Appearance feature. The Privacy — Manual Exclusion feature can be activated on such a call if the voice terminal is assigned an Exclusion button.

- Transfer

A PCOL can be transferred to an extension that does not have a button for that PCOL.

## RLT trunk group

---

The Release Link Trunk (RLT) Group form implements the Centralized Attendant Service (CAS) feature, and connects attendant-seeking calls from a branch location to a main location.

### Administration commands

---

Use the following commands to administer the RLT trunk group form.

| Action  | Object      | Qualifier <sup>1</sup>   |
|---------|-------------|--|
| add     | trunk-group | 1-MAX (or 'next')  |
| change  | trunk-group | 1-MAX or TAC X...  |
| display | trunk-group | 1-MAX ['number' X]['to-number' X]['count' N] ['tac' assigned TAC]['print' or 'schedule'] |
| list    | trunk-group | ['print' or 'schedule']  |
| remove  | trunk-group | 1-MAX or TAC X...  |

1. Brackets [ ] indicate the qualifier is optional. Single quotes ( ' ') indicate the text inside the quote must be entered exactly as shown or an abbreviated form of the word may be entered. MAX is the maximum number available in your system configuration.

### Hardware requirements

---

A port is required on a TN722B, TN767, or TN464D circuit pack for each trunk to be assigned in the Trunk Group. A TN722B or TN767 provides 24 ports, and a TN464D provides 24 or 32 ports.

### Field descriptions

---

The fields on the following forms are described in [“Trunk Groups — General”](#).



Otherwise, the valid values are:

|            |             |             |            |
|------------|-------------|-------------|------------|
| auto/delay | auto/immed  | auto/wink   | delay/wink |
| delay/auto | delay/delay | delay/immed | immed/wink |
| immed/auto | immed/delay | immed/immed | wink/wink  |
| wink/auto  | wink/delay  | wink/immed  |            |



**NOTE:**

For “immed/immed” trunks (on incoming trunks), the far-end switch seizes the trunk and then sends digits without waiting for acknowledgment from the receiving switch. When heavily loaded, the receiving switch may incur a short delay in attaching a Touch-Tone Receiver to this call and, therefore, cause it to lose digits. Using wink-start trunks or increasing the dial-guard timer value on the far-end switch avoids this problem.

**RLT group form page 2**

Page 2 of X

TRUNK FEATURES

ACA Assignment? n    Measured: none

Maintenance Tests? y

Data Restriction? n

Used for DCS? n

Suppress # Outpulsing? n

**Screen 7-82. RLT Group form (page 2)**

## Administrable Timers form

|                                   |   |
|-----------------------------------|---|
| TRUNK GROUP                       | Page Y of X                                 |
| ADMINISTRABLE TIMERS              |   |
| Incoming Disconnect(msec): 500    | Outgoing Disconnect(msec): 500              |
| Incoming Dial Guard(msec): 70     | Outgoing Dial Guard(msec): 1600             |
| Incoming Glare Guard(msec): 1500  | Outgoing Glare Guard(msec): 1500            |
| Incoming Partial Dial (sec): 18   |   |
| Outgoing End of Dial(sec): 10     | Outgoing Rotary Dial Interdigit(msec): 800_ |
| Programmed Dial Pause(msec): 1500 | Outgoing Seizure Response(sec): 5           |
|                                   | Disconnect Signal Error(sec): 240           |
|                                   | Incoming Incomplete Dial Alarm(sec): 255    |
| END TO END SIGNALING              |   |
| Tone (msec): 350                  | Pause (msec): 150                           |
| OUTPULSING TIMING                 |   |
| PPS: 10                           | Make (msec): 40                             |
|                                   | Break (msec): 60                            |

### Screen 7-83. RLT Trunk Group Administrable Timers form

#### Implementation notes

---

Incoming Dial Guard is administrable when Trunk Signaling Type is blank.

Incoming Seizure displays when Trunk Signaling Type is **cont** and Direction is **incoming**.

Outgoing End of Dial only displays when Direction is **outgoing** and Receive Answer Supervision is **n**.

Incoming Disconnect only displays when Direction is **incoming** and Trunk Signaling Type is blank or **cont**.

Outgoing Disconnect displays if Trunk Signaling Type is **blank** or **cont** and Direction is **outgoing**.

#### NOTE:

TN760Dv15 (or later) ports used in a Release Link Trunk group will have their incoming and outgoing disconnect timer value internally forced to 280 ms. All other ports in the group that take administrable timers will receive the value administered in this field. All other ports in the group that do not take administrable timers will have their disconnect timing forced to 280 ms.

### ATMS Thresholds form

Page Y of X

ATMS THRESHOLDS

TTL Type: 105-w-rl\_\_\_\_\_ Far End Test No: \_\_\_\_\_  
 TTL Vendor: \_\_\_\_\_ TTL Contact: \_\_\_\_\_  
 Trunk Vendor: \_\_\_\_\_ Trunk Contact: \_\_\_\_\_  
 Trunk Length: \_\_\_\_\_

|                          | MARGINAL |      | UNACCEPTABLE |      |
|--------------------------|----------|------|--------------|------|
|                          | Min      | Max  | Min          | Max  |
| 1004 Hz Loss:            | -2       | 21   | -2           | 21   |
|                          | -Dev     | +Dev | -Dev         | +Dev |
| 404 Hz Loss:             | 9        | 9    | 9            | 9    |
| 2804 Hz Loss:            | 9        | 9    | 9            | 9    |
| Maximum C Message Noise: | 55       |      | 55           |      |
| Maximum C Notched Noise: | 74       |      | 74           |      |
| Minimum SRL-HI:          | 0_       |      | 0_           |      |
| Minimum SRL-LO:          | 0_       |      | 0_           |      |
| Minimum ERL:             | 0_       |      | 0_           |      |

Allow ATMS Busyout, Error Logging and Alarming? y  
 Maximum Percentage of Trunks Which Can Be Removed from Service by ATMS: 0\_

Screen 7-84. RLT Group ATMS Thresholds form

### Group Member Assignments form

Page Y of X

TRUNK GROUP  
 Administered Members(min/max): xxx/yyy  
 Total Administered Members: xxx

GROUP MEMBER ASSIGNMENTS

|     | Port  | Code  | Sfx | Name  | Night | Mode  | Type  | Ans   | Delay |
|-----|-------|-------|-----|-------|-------|-------|-------|-------|-------|
| 1:  | _____ | _____ | -   | _____ | _____ | _____ | _____ | _____ | _____ |
| 2:  | _____ | _____ | -   | _____ | _____ | _____ | _____ | _____ | _____ |
| 3:  | _____ | _____ | -   | _____ | _____ | _____ | _____ | _____ | _____ |
| 4:  | _____ | _____ | -   | _____ | _____ | _____ | _____ | _____ | _____ |
| 5:  | _____ | _____ | -   | _____ | _____ | _____ | _____ | _____ | _____ |
| 6:  | _____ | _____ | -   | _____ | _____ | _____ | _____ | _____ | _____ |
| 7:  | _____ | _____ | -   | _____ | _____ | _____ | _____ | _____ | _____ |
| 8:  | _____ | _____ | -   | _____ | _____ | _____ | _____ | _____ | _____ |
| 9:  | _____ | _____ | -   | _____ | _____ | _____ | _____ | _____ | _____ |
| 10: | _____ | _____ | -   | _____ | _____ | _____ | _____ | _____ | _____ |
| 11: | _____ | _____ | -   | _____ | _____ | _____ | _____ | _____ | _____ |
| 12: | _____ | _____ | -   | _____ | _____ | _____ | _____ | _____ | _____ |
| 13: | _____ | _____ | -   | _____ | _____ | _____ | _____ | _____ | _____ |
| 14: | _____ | _____ | -   | _____ | _____ | _____ | _____ | _____ | _____ |
| 15: | _____ | _____ | -   | _____ | _____ | _____ | _____ | _____ | _____ |

Screen 7-85. RLT Group Member Assignments form

## Tandem trunk group

---

This form interconnects tandem nodes in an ETN network. The trunk group provides the system with the ability to act as an intermediate switch (through switch) in a private network and is capable of transmitting and receiving Traveling Class Marks as well as outputting 7-digit RNX-XXXX dialed numbers. A Traveling Class Mark represents a user's Facility Restriction Level (FRL) or the FRL of the user's trunk group.

### Administration commands

---

Use the following commands to administer the Tandem trunk group form.

| Action  | Object      | Qualifier <sup>1</sup>   |
|---------|-------------|--|
| add     | trunk-group | 1—MAX (or 'next')  |
| change  | trunk-group | 1—MAX or TAC X...  |
| display | trunk-group | 1—MAX ['number' X]['to-number' X]['count' N] ['tac' assigned TAC]['print' or 'schedule'] |
| list    | trunk-group | ['print' or 'schedule']  |
| remove  | trunk-group | 1—MAX or TAC X...  |

1. Brackets [ ] indicate the qualifier is optional. Single quotes ( ' ') indicate the text inside the quote must be entered exactly as shown or an abbreviated form of the word may be entered. MAX is the maximum number available in your system configuration.

### Hardware requirements

---

A port is required on a TN722B, TN760D, TN767, or TN464D circuit pack for each trunk to be assigned in the Access Trunk Group. A TN760D provides four ports, a TN722B or TN767 provides 24 or 32 ports, and a TN464D provides 32 ports.

### Field descriptions

---

The fields on the following forms are described in ["Trunk Groups — General" on page 7-115](#).

## Tandem trunk group form page 1

```
Page 1 of X

                                TRUNK GROUP

Group Number: xxx                Group Type: tandem                CDR Reports: y
  Group Name: Did - Incoming DTMF ANI  COR: 1_                TN: 1__                TAC: ____
  Direction: two-way_                Outgoing Display? n                Trunk Signaling Type: ____
  Dial Access? n                    Busy Threshold: 99_                Night Service: ____
Queue Length: 0_                    Incoming Destination: ____
  Comm Type: voice

                                BCC: _
TRUNK PARAMETERS
Trunk Type (in/out): ____                Incoming Rotary Timeout(sec): 5_
  Outgoing Dial Type: tone____                Incoming Dial Type: tone____
                                                Disconnect Timing(msec): 500_
  Digit Treatment: ____                Digits: ____
                                                Sig Bit Inversion: none
  Terminal Balanced? n                RA Trunk Loss: 0db
  Incoming Dial Tone? y                Sig Bit Inversion: none
  Bit Rate: 1200                    Synchronization: ____                Duplex: full
Disconnect Supervision - In? y  Out? n
Answer Supervision Timeout: 0__                Receive Answer Supervision? y
```

### Screen 7-86. Tandem Trunk Group form (page 1)

#### Implementation notes

BCC displays when Comm Type is **avd**, or when ISDN-PRI is optioned for on the System-Parameters Customer-Options form and Comm Type is **avd**, **rbavd**, or **data**.



## Tandem trunk group form page 2

```
change trunk-group 1                                     Page 2 of X

                                     TRUNK GROUP

TRUNK FEATURES
  ACA Assignment? n                                     Measured: none
                                                    Maintenance Tests? y
                                     Data Restriction? n

      Used for DCS? n                                     Hop Digit? n
Suppress # Outpulsing? n
      Seize When Maintenance Busy: _____

Incoming Tone (DTMF) ANI? y                             Per Call CPN Blocking Code: ____
                                                    Per Call CPN Unblocking Code: ____
```

### Screen 7-87. Tandem Trunk Group form (Page 2)

#### Fields unique to this form

---

The definition of the following field is unique to the Tandem trunk group form.

- **Hop Dgt** — The Tandem Hop Limitation feature provides a counter that reflects the number of switches (i.e., the number of hops) that a call has gone through; the counter is incremented as a call leaves DEFINITY ECS using tandem facilities. Enter **y** if you want the Tandem Hop Limitation feature applied to this trunk group; enter **n** (default) if you do not.



**NOTE:**

Never use Tandem-tie trunks to transport UDP numbers (the Hop count will not be recognized as such following the extension received at the receiving switch).

## Administrable Timers form

|                                   |   |                                  |
|-----------------------------------|---|----------------------------------|
|                                   |   | Page Y of X                      |
|                                   | TRUNK GROUP                                 |                                  |
| ADMINISTRABLE TIMERS              |   |                                  |
| Incoming Disconnect(msec): 500    |   | Outgoing Disconnect(msec): 500   |
| Incoming Dial Guard(msec): 70     |   | Outgoing Dial Guard(msec): 1600  |
| Incoming Glare Guard(msec): 1500  |   | Outgoing Glare Guard(msec): 1500 |
|                                   | Outgoing Rotary Dial Interdigit(msec): 800_ |                                  |
| Outgoing End of Dial(sec): 10     | Outgoing Seizure Response(sec): 5           |                                  |
| Programmed Dial Pause(msec): 1500 | Disconnect Signal Error(sec): 240           |                                  |
|                                   | Incoming Incomplete Dial Alarm(sec): 255    |                                  |
| END TO END SIGNALING              |   |                                  |
| Tone (msec): 350                  | Pause (msec): 150                           |                                  |
| OUTPULSING TIMING                 |   |                                  |
| PPS: 10                           | Make (msec): 40                             | Break (msec): 60                 |

### Screen 7-88. Tandem Trunk Group Administrable Timers form

#### Implementation notes

---

Incoming Dial Guard is administrable when Trunk Signaling Type is blank.

Incoming Disconnect only displays when Trunk Signaling Type is blank or **cont** and Direction is **incoming** or **two-way**.

Outgoing Disconnect only displays when Trunk Signaling Type is blank or **cont** and Direction is **outgoing** or **two-way**.

**ATMS Thresholds form**

Page Y of X

ATMS THRESHOLDS

TTL Type: 105-w-rl\_\_\_\_\_ Far End Test No: \_\_\_\_\_  
 TTL Vendor: \_\_\_\_\_ TTL Contact: \_\_\_\_\_  
 Trunk Vendor: \_\_\_\_\_ Trunk Contact: \_\_\_\_\_  
 Trunk Length: \_\_\_\_\_

|                          | MARGINAL |      | UNACCEPTABLE |      |
|--------------------------|----------|------|--------------|------|
|                          | Min      | Max  | Min          | Max  |
| 1004 Hz Loss:            | -2       | 21   | -2           | 21   |
|                          | -Dev     | +Dev | -Dev         | +Dev |
| 404 Hz Loss:             | 9        | 9    | 9            | 9    |
| 2804 Hz Loss:            | 9        | 9    | 9            | 9    |
| Maximum C Message Noise: | 55       |      | 55           |      |
| Maximum C Notched Noise: | 74       |      | 74           |      |
| Minimum SRL-HI:          | 0_       |      | 0_           |      |
| Minimum SRL-LO:          | 0_       |      | 0_           |      |
| Minimum ERL:             | 0_       |      | 0_           |      |

Allow ATMS Busyout, Error Logging and Alarming? y  
 Maximum Percentage of Trunks Which Can Be Removed from Service by ATMS: 0\_

**Screen 7-89. Tandem Trunk Group ATMS Thresholds form**

**Group Member Assignments form**

Page Y of X

TRUNK GROUP  
 Administered Members(min/max): xxx/yyy  
 Total Administered Members: xxx

| GROUP MEMBER ASSIGNMENTS | Port  | Code  | Sfx | Name  | Night | Mode  | Type  | Ans Delay |
|--------------------------|-------|-------|-----|-------|-------|-------|-------|-----------|
| 1:                       | _____ | _____ | -   | _____ | _____ | _____ | _____ | _____     |
| 2:                       | _____ | _____ | -   | _____ | _____ | _____ | _____ | _____     |
| 3:                       | _____ | _____ | -   | _____ | _____ | _____ | _____ | _____     |
| 4:                       | _____ | _____ | -   | _____ | _____ | _____ | _____ | _____     |
| 5:                       | _____ | _____ | -   | _____ | _____ | _____ | _____ | _____     |
| 6:                       | _____ | _____ | -   | _____ | _____ | _____ | _____ | _____     |
| 7:                       | _____ | _____ | -   | _____ | _____ | _____ | _____ | _____     |
| 8:                       | _____ | _____ | -   | _____ | _____ | _____ | _____ | _____     |
| 9:                       | _____ | _____ | -   | _____ | _____ | _____ | _____ | _____     |
| 10:                      | _____ | _____ | -   | _____ | _____ | _____ | _____ | _____     |
| 11:                      | _____ | _____ | -   | _____ | _____ | _____ | _____ | _____     |
| 12:                      | _____ | _____ | -   | _____ | _____ | _____ | _____ | _____     |
| 13:                      | _____ | _____ | -   | _____ | _____ | _____ | _____ | _____     |
| 14:                      | _____ | _____ | -   | _____ | _____ | _____ | _____ | _____     |
| 15:                      | _____ | _____ | -   | _____ | _____ | _____ | _____ | _____     |

**Screen 7-90. Tandem Group Member Assignments form**

## Tie trunk group

---

This form provides private access between DEFINITY ECS and another switch or network. The trunks are used to interconnect a satellite, tributary, and a main switch in an ETN. The trunk group can also be used to interface a 4ESS switch in support of MEGACOM, MEGACOM 800, and MEGACOM 800 DNIS.

### Administration commands

---

Use the following commands to administer the Tie trunk group form.

| Action  | Object      | Qualifier <sup>1</sup>   |
|---------|-------------|--|
| add     | trunk-group | 1—MAX (or 'next')  |
| change  | trunk-group | 1—MAX or TAC X...  |
| display | trunk-group | 1—MAX ['number' X]['to-number' X]['count' N] ['tac' assigned TAC]['print' or 'schedule'] |
| list    | trunk-group | ['print' or 'schedule']  |
| remove  | trunk-group | 1—MAX or TAC X...  |

1. Brackets [ ] indicate the qualifier is optional. Single quotes ( ' ') indicate the text inside the quote must be entered exactly as shown or an abbreviated form of the word may be entered. MAX is the maximum number available in your system configuration.

### Hardware requirements

---

A port is required on a TN722B, TN760D, TN767, or TN464D circuit pack for each trunk to be assigned in the Trunk Group. A TN760D provides four ports, a TN722B or TN767 provides 24 or 32 ports, and a TN464D provides 32 ports.

### Field descriptions

---

The fields on the following forms are described in [“Trunk Groups — General”](#).

## Tie trunk group form page 1

Page 1 of X

TRUNK GROUP

```

Group Number: xxx                Group Type: tie                CDR Reports: y
Group Name: Did - Incoming DTMF ANU  COR: 1_                TN: 1__                TAC: ____
Direction: two-way_                Outgoing Display? n                Trunk Signaling Type: ____
Dial Access? n                    Busy Threshold: 99_                Night Service: ____
Queue Length: 0__                Incoming Destination: ____
Comm Type: voice                    Auth Code? n
                                    Trunk Flash? n

BCC: 0
TRUNK PARAMETERS
Trunk Type (in/out): ____                Incoming Rotary Timeout(sec): 5_
Outgoing Dial Type: tone____                Incoming Dial Type: tone____
Digit Treatment: ____                Disconnect Timing(msec): 500_
                                    Digits: ____
Terminal Balanced? n                    Sig Bit Inversion: none
Incoming Dial Tone? y                    RA Trunk Loss: 0db
Bit Rate: 1200                Synchronization: ____                Duplex: full
Disconnect Supervision - In? y Out? n
Answer Supervision Timeout: 0__                Receive Answer Supervision? y
    
```

### Screen 7-91. Tie Trunk Group form (page 1)

#### Fields unique to this form

---

The following field is unique to the Tie trunk group form.

- **Line Length** — This field appears only when Trunk Signaling Type has a value of **tge**, **tgi**, or **tgu**. (Thus, this field only applies to TN497 ports.)



**NOTE:**

The value administered is not saved when the form is submitted unless one or more trunk members are administered.

#### Implementation notes

---

Answer Supervision Timeout defaults to **0**.

BCC displays when the Comm Type is **avd** or when ISDN-PRI is optioned on the System-Parameters Customer-Options form and Comm Type is **avd**, **rbavd**, or **data**.

Synchronization displays when Comm Type is **avd** or **rbavd**.

Outgoing Disconnect displays if Trunk Signaling Type is **blank** or **cont** and Direction is **outgoing** or **two-way**.

Trunk Type, Outgoing Dial Type, Incoming Dial Type, and Receive Answer Supervision do not display if Trunk Signaling Type is **tge**, **tgi** or **tgu**.

Line Length only displays if Trunk Signaling Type is **tge**, **tgi** or **tgu**.

When Trunk Signaling Type is **dis**, the valid values are:

disc/disc | disc/immed | immed/disc | immed/immed

When Trunk Signaling Type is “**cont**,” the valid values are:

|            |            |             |             |            |
|------------|------------|-------------|-------------|------------|
| auto/auto  | auto/cont  | auto/delay  | auto/immed  | auto/wink  |
| cont/auto  | cont/cont  | cont/delay  | cont/immed  | cont/wink  |
| delay/auto | delay/cont | delay/delay | delay/immed | delay/wink |
| immed/auto | immed/cont | immed/delay | immed/immed | immed/wink |
| wink/auto  | wink/cont  | wink/delay  | wink/immed  | wink/wink  |

Otherwise, the valid values are:

|            |             |             |            |
|------------|-------------|-------------|------------|
| auto/auto  | auto/delay  | auto/immed  | auto/wink  |
| delay/auto | delay/delay | delay/immed | delay/wink |
| immed/auto | immed/delay | immed/immed | immed/wink |
| wink/auto  | wink/delay  | wink/immed  | wink/wink  |

 **NOTE:**

For “immed/immed” trunks (on incoming trunks), the far-end switch seizes the trunk and then sends digits without waiting for acknowledgment from the receiving switch. When heavily loaded, the receiving switch may incur a short delay in attaching a Touch Tone Receiver to this call and, therefore, cause it to lose digits. Using wink-start trunks or increasing the dial-guard timer value on the far-end switch avoids this problem.

## Tie trunk group form page 2

```
change trunk-group 1                                     Page 2 of X

TRUNK FEATURES
  ACA Assignment? n
  Measured: none
  Internal Alert: n
  Maintenance Tests? y
  Data Restriction? n

  Used for DCS? n
  Suppress # Outpulsing? n
  Seizure When Maintenance Busy: neither-end

Incoming Tone (DTMF) ANI? y
  Connected to CO? n
  Per Call CPN Blocking Code: ___
  Per Call CPN Unblocking Code: ___
```

Screen 7-92. Tie Trunk Group form (Page 2)

## Administrable Timers form

```
ADMINISTRABLE TIMERS                                     Page Y of X

Incoming Disconnect(msec): 500
Incoming Dial Guard(msec): 70
Incoming Glare Guard(msec): 1500
Incoming Partial Dial(sec): 18
Outgoing Disconnect(msec): 500
Outgoing Dial Guard(msec): 1600
Outgoing Glare Guard(msec): 1500
Outgoing Rotary Dial Interdigit(msec): 800_
Outgoing End of Dial (sec): 10
Outgoing Seizure Response (sec): 5
Programmed Dial Pause (msec): 1500
Disconnect Signal Error(sec): 240
Incoming Incomplete Dial Alarm(sec): 255

END TO END SIGNALING
Tone (msec): 350
Pause: (msec): 150

OUTPULSING TIMING
PPS: 10
Make (msec): 40
Break (msec): 60
```

Screen 7-93. Tie Trunk Group Administrable Timers form

ADMINISTRABLE TIMERS

Incoming Glare Guard(msec): 1500\_    Outgoing Glare Guard(msec): 1500\_  
 Incoming Partial Dial(sec): 18\_    Outgoing Rotary Dial Interdigit(msec): 800\_  
 Outgoing End of Dial(sec): 10\_

OUTPULSING INFORMATION

PPS: 10    Make (msec): 40    Break (msec): 60

**Screen 7-94. Administrable Timer for TGE/TGI Type Trunk Group (two-way)**

**Implementation notes**

Incoming Dial Guard is administrable when Trunk Signaling Type is blank.

**ATMS Thresholds form**

ATMS THRESHOLDS

TTL Type: 105-w-rl\_\_\_\_\_    Far End Test No: \_\_\_\_\_  
 TTL Vendor: \_\_\_\_\_    TTL Contact: \_\_\_\_\_  
 Trunk Vendor: \_\_\_\_\_    Trunk Contact: \_\_\_\_\_  
 Trunk Length: \_\_\_\_\_

|                          | MARGINAL |      | UNACCEPTABLE |      |
|--------------------------|----------|------|--------------|------|
|                          | Min      | Max  | Min          | Max  |
| 1004 Hz Loss:            | -2       | 21   | -2           | 21   |
|                          | -Dev     | +Dev | -Dev         | +Dev |
| 404 Hz Loss:             | 9        | 9    | 9            | 9    |
| 2804 Hz Loss:            | 9        | 9    | 9            | 9    |
| Maximum C Message Noise: | 55       |      | 55           |      |
| Maximum C Notched Noise: | 74       |      | 74           |      |
| Minimum SRL-HI:          | 0_       |      | 0_           |      |
| Minimum SRL-LO:          | 0_       |      | 0_           |      |
| Minimum ERL:             | 0_       |      | 0_           |      |

Allow ATMS Busyout, Error Logging and Alarming? y  
 Maximum Percentage of Trunks Which Can Be Removed from Service by ATMS: 0\_

**Screen 7-95. Tie Trunk Group ATMS Thresholds form**



## Group Member Assignments form

Page Y of X

TRUNK GROUP

Administered Members(min/max): xxx/yy

Total Administered Members: xxx

GROUP MEMBER ASSIGNMENTS

|     | Port  | Code  | Sfx | Name  | Night | Mode  | Type  | Ans   | Delay |
|-----|-------|-------|-----|-------|-------|-------|-------|-------|-------|
| 1:  | _____ | _____ | -   | _____ | _____ | _____ | _____ | _____ | _____ |
| 2:  | _____ | _____ | -   | _____ | _____ | _____ | _____ | _____ | _____ |
| 3:  | _____ | _____ | -   | _____ | _____ | _____ | _____ | _____ | _____ |
| 4:  | _____ | _____ | -   | _____ | _____ | _____ | _____ | _____ | _____ |
| 5:  | _____ | _____ | -   | _____ | _____ | _____ | _____ | _____ | _____ |
| 6:  | _____ | _____ | -   | _____ | _____ | _____ | _____ | _____ | _____ |
| 7:  | _____ | _____ | -   | _____ | _____ | _____ | _____ | _____ | _____ |
| 8:  | _____ | _____ | -   | _____ | _____ | _____ | _____ | _____ | _____ |
| 9:  | _____ | _____ | -   | _____ | _____ | _____ | _____ | _____ | _____ |
| 10: | _____ | _____ | -   | _____ | _____ | _____ | _____ | _____ | _____ |
| 11: | _____ | _____ | -   | _____ | _____ | _____ | _____ | _____ | _____ |
| 12: | _____ | _____ | -   | _____ | _____ | _____ | _____ | _____ | _____ |
| 13: | _____ | _____ | -   | _____ | _____ | _____ | _____ | _____ | _____ |
| 14: | _____ | _____ | -   | _____ | _____ | _____ | _____ | _____ | _____ |
| 15: | _____ | _____ | -   | _____ | _____ | _____ | _____ | _____ | _____ |

### Screen 7-96. Tie Group Member Assignments form

#### Implementation notes

The Type column displays when Trunk Signaling Type is **blank** or **cont**. The Type column does not display if Trunk Signaling Type is **dis**.

The Ans Delay column displays when Trunk Signaling Type is **blank**, **cont**, or **dis**.

Mode, Type, and Ans Delay do not display if Trunk Signaling Type is **tge**, **tgi**, or **tgu**.

## WATS trunk group

---

This form provides access to and/or from a portion of the DDD network via dedicated trunks to and/or from a wide area telecommunications service (WATS) serving office.

### Administration commands

---

Use the following commands to administer the WATS trunk group form.

| Action  | Object      | Qualifier <sup>1</sup>   |
|---------|-------------|--|
| add     | trunk-group | 1—MAX (or 'next')  |
| change  | trunk-group | 1—MAX or TAC X..   |
| display | trunk-group | 1—MAX ['number' X]['to-number' X]['count' N]<br>'tac' assigned TAC]['print' or 'schedule'] |
| list    | trunk-group | ['print' or 'schedule']  |
| remove  | trunk-group | 1—MAX or TAC X..   |

- 
1. Brackets [ ] indicate the qualifier is optional. Single quotes ( ' ' ) indicate the text inside the quote must be entered exactly as shown or an abbreviated form of the word may be entered. MAX is the maximum number available in your system configuration.

### Hardware requirements

---

A port on a TN747B CO Trunk, or TN767 or TN464 DS1 Interface circuit pack is required for each WATS trunk to be assigned. A TN747 provides eight ports, a TN767 provides 24 ports, and a TN464D can provide either 24 or 32 ports.

### Field descriptions

---

The fields on the following forms are described in [“Trunk Groups — General” on page 7-115](#).



## WATS trunk group form page 2

Page 2 of X

TRUNK FEATURES

|                          |                                   |                      |
|--------------------------|-----------------------------------|----------------------|
| ACA Assignment? n        | Measured: none                    | Maintenance Tests? y |
|                          | Data Restriction? n               |                      |
| Abandoned Call Search? n |                                   |                      |
| Suppress # Outpulsing? n |                                   |                      |
| Charge Conversion: 1___  |                                   | Shuttle? y           |
| Decimal Point: none__    |                                   |                      |
| Currency Symbol: ___     |                                   | Start Position: 1    |
| Charge Type: units__     |                                   |                      |
|                          | Per Call CPN Blocking Code: ___   |                      |
|                          | Per Call CPN Unblocking Code: ___ |                      |

### Screen 7-98. WATS Trunk Group form (page 2)

#### Implementation notes

---

Shuttle displays when Country Code is **15** and Outgoing Dial Type is **rotary**.

Start Position displays when Shuttle is **y**.

#### Administrable Timers form

TRUNK GROUP Page Y of X

ADMINISTRABLE TIMERS

|                                   |  |
|-----------------------------------|--|
| Incoming Disconnect(msec): 500    | Outgoing Disconnect (msec): 500            |
|                                   | Outgoing Dial Guard(msec): 1600            |
| Incoming Glare Guard(msec): 1500  | Outgoing Glare Guard(msec): 1500           |
|                                   | Outgoing Rotary Dial Interdigit(msec): 800 |
| Ringling Monitor(msec): 5200      | Incoming Seizure(msec): 500                |
| Outgoing End of Dial(sec): 10     | Outgoing Seizure Response(sec): 5          |
| Programmed Dial Pause(msec): 1500 | Disconnect Signal Error(sec): 240          |
| Flash Length(msec): 540           |  |

END TO END SIGNALING

|                  |                   |
|------------------|-------------------|
| Tone (msec): 350 | Pause (msec): 150 |
|------------------|-------------------|

OUTPULSING INFORMATION

|         |                |                 |        |                   |
|---------|----------------|-----------------|--------|-------------------|
| PPS: 10 | Make(msec): 40 | Break(msec): 60 | PPM? y | Frequency: 50/12k |
|---------|----------------|-----------------|--------|-------------------|

### Screen 7-99. Administrable Timers for Ground Start WATS Trunk Group (two-way) with PPM

## Implementation note

---

Frequency only displays when PPM is **y**.

```
TRUNK GROUP                                     Page Y of X
ADMINISTRABLE TIMERS
  Incoming Disconnect(msec): 500                Outgoing Disconnect(msec): 500
                                           Outgoing Dial Guard(msec): 1600
  Incoming Glare Guard(msec): 1500            Outgoing Glare Guard(msec): 1500
                                           Outgoing Rotary Dial Interdigit(msec): 800
  Ringing Monitor(msec): 5200                  Incoming Seizure(msec): 500
  Outgoing End of Dial(sec): 10                Outgoing Seizure Response(sec): 5
  Programmed Dial Pause(msec): 1500
  Flash Length(msec): 540

END TO END SIGNALING
  Tone (msec): 350                             Pause: (msec): 150

OUTPUTSING INFORMATION
  PPS: 10   Make(msec): 40  Break(msec): 60  Analog PPM? y
```

### Screen 7-100. Administrable Timers for Loop Start WATS Trunk Group (two-way)

## Implementation notes

---

Outgoing End of Dial only displays if Receive Answer Supervision is **n**.

Outgoing Disconnect displays if Direction is **outgoing** or **two-way** and Trunk Type is **ground-start** or **loop-start**.

Outgoing Disconnect also displays if Direction is **outgoing** or **two-way**, Country Code is **15**, and Trunk Type is **2-wire-ac**, **2-wire-dc**, or **3-wire**.

**ATMS Thresholds form**

Page Y of X

ATMS THRESHOLDS

TTL Type: 105-w-rl\_\_\_\_\_ Far End Test No: \_\_\_\_\_  
 TTL Vendor: \_\_\_\_\_ TTL Contact: \_\_\_\_\_  
 Trunk Vendor: \_\_\_\_\_ Trunk Contact: \_\_\_\_\_  
 Trunk Length: \_\_\_\_\_

|                          | MARGINAL |      | UNACCEPTABLE |      |
|--------------------------|----------|------|--------------|------|
|                          | Min      | Max  | Min          | Max  |
| 1004 Hz Loss:            | -2       | 21   | -2           | 21   |
|                          | -Dev     | +Dev | -Dev         | +Dev |
| 404 Hz Loss:             | 9        | 9    | 9            | 9    |
| 2804 Hz Loss:            | 9        | 9    | 9            | 9    |
| Maximum C Message Noise: | 55       |      | 55           |      |
| Maximum C Notched Noise: | 74       |      | 74           |      |
| Minimum SRL-HI:          | 0_       |      | 0_           |      |
| Minimum SRL-LO:          | 0_       |      | 0_           |      |
| Minimum ERL:             | 0_       |      | 0_           |      |

Allow ATMS Busyout, Error Logging and Alarming? y  
 Maximum Percentage of Trunks Which Can Be Removed from Service by ATMS: 0\_

**Screen 7-101. WATS Trunk Group ATMS Thresholds form**

**Group Member Assignments form**

Page Y of X

TRUNK GROUP  
 Administered Members(min/max): xxx/yyy  
 Total Administered Members: xxx

GROUP MEMBER ASSIGNMENTS

|     | Port  | Code  | Sfx | Name  | Night | Mode  | Type  | Ans   | Delay |
|-----|-------|-------|-----|-------|-------|-------|-------|-------|-------|
| 1:  | _____ | _____ | -   | _____ | _____ | _____ | _____ | _____ | _____ |
| 2:  | _____ | _____ | -   | _____ | _____ | _____ | _____ | _____ | _____ |
| 3:  | _____ | _____ | -   | _____ | _____ | _____ | _____ | _____ | _____ |
| 4:  | _____ | _____ | -   | _____ | _____ | _____ | _____ | _____ | _____ |
| 5:  | _____ | _____ | -   | _____ | _____ | _____ | _____ | _____ | _____ |
| 6:  | _____ | _____ | -   | _____ | _____ | _____ | _____ | _____ | _____ |
| 7:  | _____ | _____ | -   | _____ | _____ | _____ | _____ | _____ | _____ |
| 8:  | _____ | _____ | -   | _____ | _____ | _____ | _____ | _____ | _____ |
| 9:  | _____ | _____ | -   | _____ | _____ | _____ | _____ | _____ | _____ |
| 10: | _____ | _____ | -   | _____ | _____ | _____ | _____ | _____ | _____ |
| 11: | _____ | _____ | -   | _____ | _____ | _____ | _____ | _____ | _____ |
| 12: | _____ | _____ | -   | _____ | _____ | _____ | _____ | _____ | _____ |
| 13: | _____ | _____ | -   | _____ | _____ | _____ | _____ | _____ | _____ |
| 14: | _____ | _____ | -   | _____ | _____ | _____ | _____ | _____ | _____ |
| 15: | _____ | _____ | -   | _____ | _____ | _____ | _____ | _____ | _____ |

**Screen 7-102. WATS Group Member Assignments form**

## Automatic Routing

# 8

---

This section contains the following DEFINITY ECS Automatic Routing features. Automatic Routing forms are located at the end of this chapter.

| <b>Feature</b>  | <b>Page</b>          |
|---|----------------------|
| <a href="#">AAR and ARS</a>   | <a href="#">8-3</a>  |
| <a href="#">AAR and ARS Overlap Sending</a>                           | <a href="#">8-20</a> |
| <a href="#">AAR and ARS Partitioning</a>                              | <a href="#">8-21</a> |
| <a href="#">Facility Restriction Levels and Traveling Class Marks</a> | <a href="#">8-24</a> |
| <a href="#">Alternate Facility Restriction Levels</a>                 | <a href="#">8-29</a> |
| <a href="#">Generalized Route Selection</a>                           | <a href="#">8-33</a> |
| <a href="#">Look-Ahead Routing</a>                                    | <a href="#">8-45</a> |
| <a href="#">Subnet Trunking</a>                                       | <a href="#">8-48</a> |
| <a href="#">Time of Day Routing</a>                                   | <a href="#">8-50</a> |

| <b>Form</b>                             | <b>Page</b>          |
|---|----------------------|
| <a href="#">Automatic Routing Forms</a> | <a href="#">8-54</a> |

## **Automatic Routing — General**

---

DEFINITY ECS provides a variety of automatic-routing features for public and private networks. Automatic Alternate Routing (AAR) and Automatic Route Selection (ARS) are the foundation for these automatic-routing features. They route calls based on the preferred (normally the least expensive) route available at the time the call is placed. Generally, AAR routes calls over a private network and ARS routes calls using the public network numbering plan. However, both AAR and ARS support public and private networks.

When you use AAR and ARS, you can also use the following additional features:

- AAR/ARS Overlap Sending
- AAR/ARS Partitioning
- Facility Restriction Levels (FRL) and Traveling Class Marks (TCM)
- Alternate Facility Restriction Levels (AFRL)
- Generalized Route Selection (GRS)
- Look Ahead Routing (LAR)
- Subnet Trunking
- Time of Day (TOD) Routing



## AAR and ARS

---

### AAR

AAR supports private networks. Private network calls originate and terminate at one or many customer locations without accessing the public network. When you dial an access code and phone number, AAR selects the most desirable route for the call and performs any necessary digit conversion. If the first choice is unavailable, another trunk group, if administered, is chosen automatically.

The numbers you call using AAR are normally private-network numbers. However, you can call a public-network number, a service code, an international number, operator access code, or an operator-assisted dialing number. With AAR and Subnet Trunking, you have a convenient way to place international calls to frequently-called foreign cities. Such calls route as far as possible over the private network, and then access the public network. This saves toll charges and allows you to use your private network as much as possible.

Certain domestic calls may reach a point on a private network where they can route no further because tie trunks to the next switch are unavailable. In this case, subnet trunking can delete the location code and insert the appropriate public-network code. Calls of this type route off of the private network to a central office (CO). The CO may be connected to either a private-network tandem or main switch. Toll charges, if any, are from the final ETN switch to the destination.

### ARS

ARS selects carriers automatically and routes calls inexpensively over the public network. When there are one or more long-distance carriers or services, DEFINITY ECS selects the most preferred route for the call. Long-distance carrier-code dialing may not be required on routes selected by the system. You assign long-distance carrier-codes and DEFINITY ECS translates them. The system can insert codes as needed to guarantee automatic carrier selection.

ARS can route calls to a variety of types-of-numbers (TON):

- Local dialing
- National dialing
- International dialing
- Operator-assisted dialing
- Service codes
- Inter-exchange carrier (IXC)

ARS can access a variety of types of public-network and private-network trunk groups including CO, FX, ISDN, tie, and WATS. See each trunk group type in other sections of this manual for additional information.

## How to administer AAR and ARS

### Required forms for AAR

| <u>Form</u>                             | <u>Field</u>  | <u>Page</u>                                    |
|---|---|--|
| Dial Plan Record                        | ■ Feature Access Code   | <a href="#">5-99</a>                           |
| Class of Restriction                    | ■ FRL<br>■ Calling Party Restriction<br>■ Partitioned Group Number<br>or<br>■ Time of Day Plan Number | <a href="#">5-72</a>                           |
| Feature Access Codes                    | ■ AAR Access Code<br>■ ARS Access Code  | <a href="#">5-113</a><br><a href="#">5-113</a> |
| AAR and ARS Digit Analysis Table        | ■ All   | <a href="#">8-54</a>                           |
| AAR and ARS Digit Conversion Table      | ■ All   | <a href="#">8-63</a>                           |
| Node Number Routing (optional)          | ■ All   | <a href="#">12-119</a>                         |
| Route Pattern                           | ■ All   | <a href="#">8-67</a>                           |
| Remote Home Number Plan Area (optional) | ■ All   | <a href="#">8-76</a>                           |
| Time of Day Routing Plan (optional)     | ■ All   | <a href="#">8-78</a>                           |
| Feature-Related System Parameters       | ■ AAR/ARS Dial Tone Required  | <a href="#">5-123</a>                          |

- Private Networking must be enabled on the System-Parameters Customer-Options form before you can use an AAR Feature Access Code.
- ARS networking must be enabled on the System-Parameters Customer-Options form before you can use an ARS Feature Access Code.

**Required forms for ARS**

| <b>Form</b>  | <b>Field</b>                 | <b>Page</b>           |
|--|------------------------------|-----------------------|
| Class of Restriction                               | ■ FRL                        | <a href="#">5-72</a>  |
|  | ■ Calling Party Restriction  |                       |
|  | ■ Restricted Call List       |                       |
|  | ■ Partitioned Group Number   |                       |
|  | OR                           |                       |
| Dial Plan Record                                   | ■ Time of Day Chart          |                       |
|  | ■ Area Code                  | <a href="#">5-99</a>  |
| Feature Access Codes                               | ■ ARS Prefix 1 Required      |                       |
|  | ■ ARS Access Code            | <a href="#">5-113</a> |
| Toll Analysis                                      | ■ AAR Access Code            | <a href="#">5-113</a> |
|  | ■ Dialed String              | <a href="#">5-299</a> |
| AAR and ARS Digit Analysis Table                   | ■ Min/Max                    |                       |
|  | ■ RCL                        |                       |
|  | ■ UCL (1-10)                 |                       |
|  | ■ Toll List                  |                       |
|  | ■ All                        | <a href="#">8-54</a>  |
| AAR and ARS Digit Conversion Table                 | ■ All                        | <a href="#">8-63</a>  |
| Route Pattern                                      | ■ All                        | <a href="#">8-67</a>  |
| Remote Home Numbering Plan Area (RHNPA) (optional) | ■ All                        | <a href="#">8-76</a>  |
| ARS Toll Table (optional)                          | ■ All                        | <a href="#">8-75</a>  |
| Time of Day Routing Plan (optional)                | ■ All                        | <a href="#">8-78</a>  |
| Feature-Related System Parameters                  | ■ AAR/ARS Dial Tone Required | <a href="#">5-123</a> |

## **Detailed description**

---

A detailed description of AAR and ARS follows. Included is information on dialing, digit analysis, digit conversion, and route pattern. Considerations and interactions that involve implementation are addressed.

More detailed information is provided in Expanded Technical Information. Included is an explanation of AAR dialing, ARS dialing, call processing, and electronic tandem networks (ETN). Finally, the following additional related features are addressed: AAR/ARS Partitioning, Facility Restriction Levels and Traveling Class Marks, Alternate Facility Restriction Levels, Generalized Route Selection, Look Ahead Routing, Overlap Sending, Subnet Trunking, and Time of Day Routing.

Review [Figure 8-1](#) for an overview of the automatic routing.

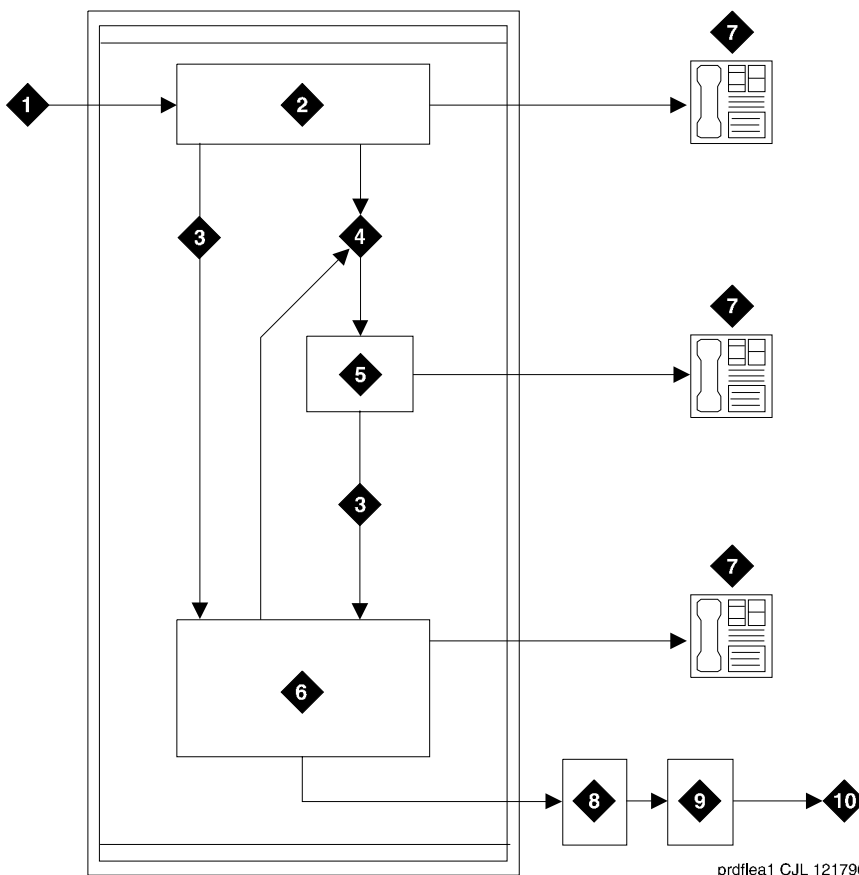

Figure Notes

1. Input from voice terminal, public network trunk, or private network trunk
2. Analyze digits to determine address type (First Digit Table)
3. Direct to AAR/ARS
4. Direct to Uniform Dial Plan (UDP)
5. Analyze digits using UDP to determine route
6. Delete and insert digits (AAR and ARS Digit Conversion Tables)
7. Terminate call at voice terminal
8. Analyze digits (AAR and ARS Digit Analysis Tables) and determine route pattern (Route Pattern, Node Number Routing, Extended Trunk Access forms)
9. Select outgoing trunk group and delete and insert digits
10. Output to public network trunk or private network trunk

Figure 8-1. Automatic Routing

## Dialing

Automatic routing starts when you dial a feature access code followed by the number to be called. For AAR, this access code is usually the digit 8. For ARS, this access code is usually the digit 9 in the US and 0 outside of the US.

As soon as you dial the AAR or ARS access code, the system checks to see if your voice-terminal extension has been origination restricted or outward restricted by its assigned Class of Restriction (COR). The system also checks to see if you have a controlled restriction of either outward or total. If any of these restrictions exist, intercept treatment is applied to the call. Otherwise, the AAR or ARS call continues and you can enter the number to be called.

A second dial tone may or may not be heard after the AAR or ARS access code is dialed, depending on system administration. For more detailed information, see Expanded Technical Information.

### Interdigit timeout

DEFINITY ECS uses a long interdigit timer and a short interdigit timer during the dialing process. Normally, a long, 10-second interdigit timer is used between each digit. This timer waits for another digit when the digits dialed are not a valid destination. If this timer runs out, you receive timeout and an intercept tone.

If the digits dialed point to a valid destination, but there is a similar string of digits that is of different length, the short, 3-second interdigit timer is started.

If dialing does not continue before the timers expire, the system assumes that no more digits are to follow, and appends # to indicate end of dialing. You also may override the timer by dialing #. This results in faster call processing.

When no length ambiguity exists and all digits are collected, the call is routed, and no timer or # is required.

## Digit analysis

Digit analysis compares the dialed number (or incoming digit string) with entries in the AAR or ARS Digit Analysis Table depending on which Dial Access Code was utilized. When DEFINITY ECS finds a dialed-string entry in the table that matches the incoming digit string, the AAR or ARS Digit Analysis Table maps the incoming digit string to a specific route pattern and call type. The selected route pattern and call type are used to route the call. The AAR or ARS Digit Analysis Table also shows the minimum and maximum number of digits required for the analysis of each incoming digit string. Node-number routing can also be specified on this form.

A dialing pattern can be mapped directly to a specific route pattern and call type. Or, it can be changed in the AAR or ARS Digit Conversion Table. During digit conversion, digits may be inserted or deleted from the digit string. For instance, private network numbers may be converted to other private network

numbers or public network numbers or extensions. This new dialed string is analyzed again in the appropriate analysis table for routing. Matching criteria are (most important first):

- Number of digits (between min and max)
- Most number of matching digits
- Exact match over wildcard match (from left to right)

## Digit conversion

When an access code and number are dialed, the dialed string is compared to entries in the `Matching Pattern` field of the ARS or AAR Digit Conversion Table. If all or part of the dialed string matches one of the Matching Patterns, the matching part of the dialed string is replaced by a new number from the Replacement String field. This new number then is used to route the call. The new number is analyzed using the AAR or ARS Digit Analysis Table or is routed directly to an extension. An intercept tone is supplied if a match is not found or if the call fails to route.

Review the following examples. These conditions are assumed for the examples: ARS Access Code = 9, AAR Access Code = 8, Home RNX (Private Network Office Code) = 222, Prefix 1 is required on all long-distance DDD calls, Dashes (-) shown in [Table 8-1](#) are for readability only. The dialed digits are mapped to the matching pattern that most closely matches the dialed number.

### Example:

If the dialed string is 957-1234 and matching patterns 957-1 and 957-123 are in the table, the match is on pattern 957-123. The call is routed as dialed.

Table 8-1. ARS Digit Conversion Examples

| Operation  | Actual Digits Dialed           | Matching Pattern     | Replacement String | Modified Address | Notes   |
|--|--------------------------------|----------------------|--------------------|------------------|---|
| DDD call to ETN  | 9-1-303-538-1345               | 1-303-538            | 362                | 362-1345         | Call routes via AAR for RNX 362   |
| Long-distance call to presubscribed carrier                                    | 9-10222+DDD                    | 10222                | (blank)            | (blank)          | Call routes as dialed with DDD # over private network   |
| Terminating a local DDD call to an internal station                            | 9-1-201-957-5567 or 9-957-5567 | 1-201-957-5 or 957-5 | 222-5              | 222-5567.        | Call goes to home RNX 222, ext. 5567  |
| Unauthorized call to intercept treatment                                       | 9-1-212-976-1616               | 1-XXX-976            | #                  | (blank)          | "#" means end of dialing. ARS ignores digits dialed after 976. User gets intercept treatment.   |
| International calls to an attendant  | 9-011-91-672530                | 011-91               | 222-0111#          | 222-0111         | Call routes to local switch (RNX 222), then to attendant (222-0111). Call can route to an announcement by replacing 0111 with an announcement extension. <sup>1</sup> |
| International call from certain European countries needing dial tone detection | 0-00-XXXXXXXX                  | 00                   | +00+ <sup>2</sup>  | 00+XXXX          | The first 0 denotes ARS, the second pair of 0s denotes an international call, the pluses denote "wait" for dial tone detection.                                       |

1. This method may also be used to block unauthorized IDDD calls.
2. This can be done via subnet trunking

## Route pattern

DEFINITY ECS selects a route pattern for a call as a result of the digit analysis performed on the number dialed. The AAR or ARS Digit Analysis Table analyzes up to 28 digits. An RHNPA Table **is used to screen 3 additional digits after an area code**. A route pattern is a sequence of trunk groups that are used to route the call. (More than one combination of dialed digits can point to the same route pattern.)



You relate a Dialed String (number dialed) to a Rte Pat (route pattern) on the AAR or ARS Digit Analysis Table. You set up the Rte Pat on the Route Pattern form. Usually, you arrange the trunk groups in a route pattern by preference. The least expensive route pattern is generally the preferred route. To select a route pattern, DEFINITY ECS considers preference order and FRL compatibility.

You also assign an FRL to a routing-pattern preference. FRLs are assigned to both trunk groups and voice terminals via the COR. The caller's FRL must be greater than or equal to the preference FRL. See the section on Facility Restriction Levels and Traveling Class Marks for additional information.

When AAR and ARS route calls over ISDN trunk groups, overlap sending can be administered. This allows you to send and receive digits one digit at a time instead of enbloc (digits are not sent until the entire group of digits is received). In countries with complex public-network numbering plans, this decreases call setup time significantly. When overlap receiving is enabled, this is especially significant for tandemed calls.

If AAR routes the call to another switch over a trunk with ISDN overlap sending, the system seizes the outgoing ISDN trunk and starts sending digits while DEFINITY ECS continues to collect (receive) the remaining incoming digits. After receiving the number of digits administered in the Max. digit field of the AAR Digit Conversion Table (or a timeout), the system sends an end-of-dial signal backward to the originating switch. With overlap sending, it also is no longer necessary to enter # to indicate end of dialing. Additional information is provided in the section on Overlap Sending.

Look-Ahead Routing allows you to maximize your route-pattern preferences. It allows you to continue to try to reroute an outgoing ISDN call when initial attempts fail because of congested trunks. You can indicate the next route-pattern preference or indicate that the current route-pattern preference should be attempted a second time before going to the next preference. Additional information is provided in the section on Look-Ahead Routing.

## **Expanded technical information**

---

The following paragraphs contain further information about AAR dialing and translations, ARS dialing and translations, and trunking facilities.

### **AAR dialing**

Typically, AAR simplifies dialing. You dial the AAR access code (normally 8) followed by a private network or public network number. AAR selects the route and performs whatever digit manipulation is necessary. In addition, AAR selects the most cost-effective public-network or private-network route. If the first-choice preference is not available, another preference is chosen automatically. For outgoing ISDN calls, route selection is dependent on Bearer Capability Class (BCC), Facility Restriction Level (FRL), and type of facility.

AAR allows you to dial a private network number to reach a specific public network. The call can be routed via a private network to an appropriate exit point, where digit insertion is used for conversion to the appropriate access code, country code, city code, and exchange.

You can administer DEFINITY ECS to include RN, RNX, and RXX dial plans, where R = 2 to 9, N = 2 to 9, and X = 0 to 9 (and any other forms). See the following table for default translations associated with AAR Digit Analysis.

**Table 8-2. AAR Digit Analysis Default Translations**

| Dialed String | Total Digits |      | Call Type |
|---------------|--------------|------|-----------|
|               | Min.         | Max. |           |
| 2             | 7            | 7    | aar       |
| 3             | 7            | 7    | aar       |
| 4             | 7            | 7    | aar       |
| 5             | 7            | 7    | aar       |
| 6             | 7            | 7    | aar       |
| 7             | 7            | 7    | aar       |
| 8             | 7            | 7    | aar       |
| 9             | 7            | 7    | aar       |

### ARS dialing

You can administer DEFINITY ECS to recognize different types of dialing patterns on outgoing calls and route the call accordingly. The following dialing patterns are supported.

- **Operator Assistance Calls** — The first digit following the ARS access code is a 0. If a 0 is dialed by itself to access an operator, a special interdigit timeout occurs, the route for dial 0 calls is selected and a 0# is outpulsed. If the user dials another 0, the route for 00 is selected, and a 00# is outpulsed. The call is routed to the toll operator (if one exists) instead of the local operator in this case.
- **DDD Calls with Prefix Digit 1 Required** — The `Pfx Mrk` (Prefix Mark) field (on the Route Pattern form) is administered as follows for each of the 6 possible routing choices on the form:

The digit 1 may or may not be required at the public network office to which the call is routing. (If 1 is dialed on 7-digit calls at a stand-alone system (non-ETN), the 1 is outpulsed by the system.) In the other cases, the 1 outpulsing requirements are indicated in the system. Since any given call may have a choice of routes, some of which may require a 1 and some of which may not, this indication is associated with each route. Five

choices are available and are identified in translations by a Prefix Mark. Digit 1 outpulsing only applies to calls administered as "fnpa" or "hnpa" in the ARS Digit Analysis table. The values and meanings of the Prefix Marks are as follows:

- Prefix Mark 0 — Suppress a user-dialed Prefix digit 1 for 10-digit FNPA calls, but leave a user-dialed Prefix digit 1 for the following types of calls:
  - 10-digit calls that are not administered as FNPA or HNPA types in the ARS Routing Table.
  - 7-digit HNPA calls
- Prefix Mark 1 — Send a 1 on 10-digit calls, but not on 7-digit calls.
- Prefix Mark 2 — Send a 1 on all toll calls (for example, all 10-digit calls and 7-digit toll calls).
- Prefix Mark 3 — Send a 1 on all toll calls and keep or insert the NPA to ensure that all toll calls are 10-digit calls. Note that a user-dialed Prefix digit 1 for a 7-digit call makes it a toll call and, hence, NPA is also inserted in this case.
- Prefix Mark 4 — Always suppress a user-dialed Prefix digit 1.



**NOTE:**

This capability is required, for example, when routing ISDN calls to an Lucent Technologies 4ESS. If the prefix digit 1 were not suppressed, then the 4ESS would reach calls.

Which of the five possible treatments of the 1 prefix digit should be administered on a given route is based on the characteristics of the distant office. Prefix Mark 0 prevents the system from sending a 1 prefix digit for 10-digit FNPA calls. However, the system leaves a user-dialed prefix digit 1 for 7-digit HNPA calls and 10-digit calls that are not administered as FNPA or HNPA types in the ARS Routing Table. In some areas, all toll calls must be dialed as 1+10 digits. Check with your local network provider.

Prefix Mark 1 causes the system to send a 1 prefix on all 10-digit FNPA calls.

With Prefix Marks 2 and 3, the decision is based on whether the call is a toll call. Toll Lists are provided in the system to furnish this information. A Toll List simply indicates if the office code associated with the call constitutes a toll call from the interconnecting office (not from the local system). Up to 32 Toll Lists are provided. The applicable list number, if any, for the call is assigned in the Routing Pattern.

Prefix Marks are only applicable on 7- or 10-digit DDD public network calls. Requirements for outpulsing a 1 are specified via Prefix Marks and go into effect when the call accesses is outpulsed. Digit 1 outpulsing only applies to calls administered as "fnpa" or "hnpa" in the ARS Digit Analysis table.

- **DDD Calls with Prefix Digit 1 Not Required** — The first digit of a long-distance call following the ARS access code may or may not be a 1 (dialing the 1 prefix before a 10-digit call is optional). In systems where the 1 prefix is dialed (even though not required), the prefix is ignored if no match is found with the “1” included. The default ARS translations include entries starting with “1.”
- **Operator Assisted and International Calls** — The first digits following the ARS access code are a 0 (operator), 00 (toll operator), and optionally followed by a 10-digit DDD number, or by 01 or 010 (international operator) for international dialing and optionally followed by international destination address digits. Because of the variable number of digits required for these calls, an interdigit timeout is used to recognize end of dialing.
- **International Direct Distance Dialing** — An international telephone number consists of a country code (CC) plus the national number (NN). The NN is simply the number used when calling within the country. In the North American Numbering Plan (NANP), NN is a 10-digit address. In the NANP, special prefix codes alert DEFINITY ECS that an international number is being dialed. These codes are outlined as follows:
  - 011 — Indicates that the caller is making a station paid direct international call and CC plus NN digits follow. The term IDDD (International Direct Distance Dialing) is normally associated with 011 plus (011+) station calls.
  - 01 — Indicates that the caller desires operator assistance in an international call, such as person-to-person, credit card, collect call, and so on, and CC and NN digits follow. The term ICDOS (International Customer-Dialed and Operator-Serviced) reflects the nature of 01+ dialing options.

A 01+ (ICDOS) call is similar to 0+ or 00+ (operator-assisted North American Network) call, whereas a 011+ (IDDD) call is similar to a 1+ call.
- **Special Service Codes** — The first digit following the ARS Access Code is a special system or service code. In North America, such codes consist of only three digits in the form N11 (where N = 2 to 9) with or without dialing the “1” prefix digit. These are recognized as complete addresses, and even if no further digits are dialed, are routed to the appropriate facility. The interdigit timeout determines whether the call is a 3- or 7-digit call. For example, if the user dials 911, the call routes to the police or emergency operator, and if the user dials 811-XXXX, the call is translated as a 7-digit call for the repair bureau corresponding to the last 4 digits (811 is a service code for repair).
- **Call Dialed with Inter-Exchange Carrier (IXC) Access** — The IXC Code, if dialed, is comprised of the first digits following the ARS Access Code, usually a 5- or 7-digit IXC code. IXC codes are defined in the Inter-Exchange Carrier Codes form on page [5-177](#). DEFINITY ECS decides the number of digits to collect based on the digits following the

code. The IXC code may be followed by a DDD or IDDD number. This gives you control over which carriers or which facilities are used for routing the call. The call may be routed based on administration of the IXC code in the ARS Digit Analysis Table.

DEFINITY ECS supports three general IXC access arrangements that are commonly referred to as Feature Group A, B, and D (FG A, FG B, FG D). From a caller's perspective, the major differences between use of the various groups are:

- To select an IXC, FG A and FG B require the dialing of 7 digits (NXX-XXXX or 950-0/1XXX, respectively) but FG D requires just 5 digits (10XXX).
- Single-stage dialing is supported for FG D, but FG A and FG B require 2-stage dialing. (Two-stage dialing means that there is a pause for dial tone between the 2 groups of dialed digits.) FG A and FG B calls are analyzed and routed just like normal calls.
- No customer identification digits are required for FG D.
- A touch-tone telephone is required to enter a Personal Identification Number code when using FG A or FG B. (These digits are not collected or analyzed by the switch.) A dial pulse or touch-tone telephone may be used with FG D.

See [Table 8-3](#) for default translations associated with ARS digit analysis.

**Table 8-3. ARS Digit Analysis Default Translations**

| Dialed String | Total Digits |      | Route Pattern | Call Type |
|---------------|--------------|------|---------------|-----------|
|               | Min.         | Max. |               |           |
| 0             | 1            | 1    | den           | op        |
| 0             | 8            | 8    | den           | op        |
| 0             | 11           | 11   | den           | op        |
| 00            | 2            | 2    | den           | op        |
| 01            | 9            | 17   | den           | iop       |
| 011           | 10           | 18   | den           | intl      |
| 10XXX0        | 6            | 6    | den           | op        |
| 10XXX0        | 16           | 16   | den           | op        |
| 10XXX1        | 16           | 16   | den           | fnpa      |
| 10XXX01       | 14           | 22   | den           | iop       |
| 10XXX011      | 15           | 23   | den           | intl      |

*Continued on next page*

**Table 8-3. ARS Digit Analysis Default Translations — Continued**

| Dialed String | Total Digits |      | Route Pattern | Call Type |
|---------------|--------------|------|---------------|-----------|
|               | Min.         | Max. |               |           |
| 1XXX555       | 11           | 11   | den           | fnpa      |
| 1XXX976       | 11           | 11   | den           | fnpa      |
| 18000555      | 11           | 11   | den           | fnpa      |
| 1809          | 11           | 11   | den           | fnpa      |
| 1900555       | 11           | 11   | den           | fnpa      |
| 411           | 3            | 3    | den           | svct      |
| 555           | 7            | 7    | den           | hnpa      |
| 611           | 3            | 3    | 1             | svcl      |
| 811           | 3            | 3    | 1             | svcl      |
| 911           | 3            | 3    | 1             | svcl      |
| 976           | 7            | 7    | den           | hnpa      |
| N             | 7            | 7    | 2             | hnpa      |
| 1N00          | 11           | 11   | den           | fnpa      |
| 1NX           | 11           | 11   | den           | fnpa      |

Legend:

- N - 2 through 9
- X - any digit (0 - 9)
- den - deny
- fnpa - foreign number plan area (10-digit call)
- hnpa - home number plan area (7-digit call)
- intl - international
- iop - international operator
- op - operator
- svcl - service (local)
- svct - service (toll)

## Trunking facilities

Automatic routing uses a combination of public and private trunking facilities. Off-net facilities include trunks such as CO, FX, and WATS. These trunks carry public network calls. On-net facilities include trunks such as tie, tandem, and private ISDN trunks. These trunks are dedicated to your private network.

DEFINITY ECS can serve as an electronic tandem network (ETN). An ETN is a hierarchical network of privately-owned trunk and switching facilities that provide a cost-effective alternative to toll calling between locations. Tandem trunks are used to interconnect two tandem nodes in an ETN.

An ETN consists of tandem switches, the intertandem tie trunks that interconnect them, the access- or bypass-tie trunks from a tandem switch to a main switch, and the capability to control call routing over these facilities. Within an ETN, each switching facility is identified by a unique private-network office code. Private-network office codes may be 1–8 digits.

Traveling Class Marks (TCM) are appended to AAR and ARS numbers outpulsed on ETNs. Remember, TCMs represent the caller's FRL or the FRL of the caller's access trunk group. Access trunks are used to connect a subtending main switch to a tandem node. Tie trunks are used to interconnect a satellite or tributary and the homing main switch. An ETN tandem node can, however, directly access main and tributary switches that are homed on another tandem node using bypass-access trunks.

## Considerations

---

- ARS and AAR can access the same trunk groups and share the same route patterns, toll lists, and RHNPA tables. ARS calls can be converted to AAR calls and vice-versa.
- Internal memory resources used for digit analysis are shared by ARS and AAR Digit Conversion and Toll Analysis. The Percent Full field on the ARS Digit Analysis and AAR Digit Analysis screens indicates how many of these resources are used for both AAR and ARS.

## Interactions

---

- Abbreviated Dialing  
FRL checking is bypassed on ARS and AAR calls made via a privileged Abbreviated Dialing Group List.
- Attendant Control of Trunk Group Access  
Attendant control of a trunk group, in effect, removes the trunk group from the route pattern. ARS and AAR do not access controlled trunk groups.
- CAS  
A CAS Attendant can extend a call out of a branch switch using ARS and AAR. When you dial the feature access code and number, the call is routed according to the AAR and ARS administration at the branch switch.

- CDR
  - A CDR account code may be required for an AAR call if it crosses over and becomes an ARS call.
  - An ARS or AAR call using a trunk group marked for CDR is indicated by the dialed access code and by a condition code. It is possible to record either the dialed number or the outpulsed number. If the dialed number is recorded, subnet trunking does not affect CDR.
  - Outpulsed digits can be recorded.
  - If CDR generation is administered for a trunk group assigned to a route pattern, data is collected for all calls routed through the trunk group.
  - If a CDR account code is to be dialed with an ARS or AAR call, it must be dialed before the ARS or AAR access code is dialed.
- Controlled Restriction, Origination Restriction, and Outward Restriction

These features prohibit access to ARS and AAR.
- Forced Entry of Account Codes

Prefix marks and other digits inserted from route patterns are not used to determine whether a call is a toll call. See Forced Entry of Account Codes below for more information.
- ISDN-BRI Stations

An ISDN-BRI station does not recognize the conference or transfer buttons until a call is ready to be routed. For calls that require an interdigit timeout, you must delay dialing for 3 seconds or dial a # to indicate that the call is ready to be routed. The routing operation is completed by the switch and then the ISDN-BRI station recognizes the conference or transfer buttons.
- Miscellaneous Trunk Restrictions

Miscellaneous Restrictions are not checked on ARS and AAR calls.
- Personal Central Office Line (PCOL) Trunk

A PCOL trunk group cannot be assigned to a route pattern.
- Ringback Queuing
  - Ringback Queuing can be used on ARS and AAR calls when they originate at a switch that provides the queuing. Incoming tie trunk calls do not queue on an outgoing trunk group.
  - Ringback Queuing is activated automatically when you have an Automatic Callback button, make an ARS or AAR call, and all trunks are busy.



- Toll Restriction

Toll Restriction is checked if calls are dialed as ARS calls; it is not checked on AAR calls even if they digit convert to ARS calls.

- Voice Terminal Display

- The voice terminal display shows the dialed digits (not outpulsed digits) on AAR and ARS calls and then may change to the name of the trunk group.
- On ARS calls, the called party shown on the display is that of the trunk group actually used. The Miscellaneous Call Identification field on the display shows ARS. By administering trunk groups, you can replace the dialed digits with the name of the trunk group and trunk access code (TAC).
- Outgoing AAR calls display the trunk name and TAC.
- An ISDN-BRI station may format these display fields differently, and the timing of display updates may be different.

## AAR and ARS Overlap Sending

DEFINITY ECS supports overlap sending for AAR and ARS calls that are routed over ISDN trunk groups. ISDN call-address information is sent one digit at a time instead of enbloc — in other words, all address information in one block. In countries with complex public-network numbering plans, this allows for a significant decrease in call setup time. When overlap receiving is enabled, this is especially significant for tandemed calls.

If AAR or ARS determines that the call is to be routed to another switch over a trunk with ISDN overlap sending, the system seizes the outgoing ISDN trunk and starts sending digits while DEFINITY ECS continues to collect (receive) the remaining incoming digits. After receiving the number of digits administered in the `Max` field of the AAR or ARS Digit Analysis form (or a timeout), the system sends an end-of-dial signal backward to the originating switch. It is no longer necessary to enter # to indicate end of dialing.

### How to administer AAR and ARS Overlap Sending

#### Required forms

| Form                 | Field                     | Page                  |
|----------------------|---------------------------|-----------------------|
| ISDN-PRI Trunk Group | ■ Digit Handling (in/out) | <a href="#">7-219</a> |
| ISDN-BRI Trunk Group | ■ Digit Handling (in/out) | <a href="#">7-198</a> |

## AAR and ARS Partitioning

AAR and ARS can be partitioned into 8 user groups within a single DEFINITY ECS. AAR and ARS Partitioning provides individual routing treatment for each of these user groups.

User groups share the same Partition Group Number (PGN). The PGN is not a restriction; it indicates the choice of routing tables used on a particular call. Each Class of Restriction (COR) is assigned a specific PGN or Time of Day specification. Different CORs may be assigned the same PGN.

### How to administer AAR and ARS Partitioning

#### Required forms

| <u>Form</u>                         | <u>Field</u>               | <u>Page</u>          |
|-------------------------------------|----------------------------|----------------------|
| Class of Restriction                | ■ Partitioned Group Number | <a href="#">5-72</a> |
| Time of Day Routing Plan (optional) | ■ All                      | <a href="#">8-78</a> |
| AAR and ARS Digit Analysis Table    | ■ Partitioned Group Number | <a href="#">8-54</a> |

- Different Digit Analysis tables must be administered for each partitioned user group.
- A PGN must be assigned to each COR table. A Time of Day Plan Number is assigned to the COR instead of the PGN if Time of Day Routing is used.

### Detailed description

This feature allows you to divide users into groups and restrict or allow different access to facilities depending upon the group. In motels, for instance, AAR and ARS Partitioning allows you to group employees and guests and give them different access to facilities. When a guest places an interstate call, the guest user-group's ARS tables can route the call to a telephone-billing information system that bills back or allocates long-distance charges. A similar call placed by an employee can route over a direct-distance dialing (DDD) trunk.

All partitioned user groups share the same pool of route patterns. The translation tables that specify the route-pattern number are unique for each partitioned user group. Route patterns may be shared among the user groups or may be dedicated to a particular user group. Once you activate AAR or ARS and dial enough digits for the system to search for the route pattern, the PGN of the caller's COR is used to select the table to look up the route pattern.

The following can use AAR and ARS Partitioning:

- Voice terminals
- Attendant consoles
- Remote-access users
- Data endpoints
- Incoming trunks

## Considerations

- The following situations may require AAR and ARS Partitioning:
  - User groups with different routing preferences for calls to a given area due to special billing needs
  - User groups that have dedicated use of a particular network facility
  - User groups in different businesses in one or more buildings serviced by a single system
  - Data users who require special facility types on outgoing calls
- Partition user groups are only used with AAR, and ARS, and UDP. There is no capability to access the partitioned user groups directly. Operation is transparent to the user.

## Interactions

- Bridged Call Appearance

If a Bridged Call Appearance is used for an AAR or ARS call, the system uses the bridged extension's PGN instead of the caller's PGN.
- Call Detail Recording (CDR)

The PGN used to route the call is not recorded in CDR.
- Call Forwarding All Calls

If a call terminates at a voice terminal that has Call Forwarding activate and the forwarded-to number uses AAR or ARS, the caller's COR is used to look up the PGN for the call.
- DCS

When a call routes over DCS, PGN information is not sent to the far-end switch. The far-end switch is only capable of using the incoming trunk's PGN to route the call.
- Remote Access

If a remote-access user activates ARS, the COR assigned to the barrier code dialed (or the Authorization Code, if required) is used to select the PGN for the call.

- Straightforward Outward Completion and Through Dialing

If the attendant assists or extends a call and activates ARS, the attendant's COR is used to select the PGN for the call if the individual extension number is assigned, otherwise it refers to the COR set on the console parameter.

- Time of Day Routing

TOD Routing allows different AAR and ARS Partitions to be used at different times of the day and different days of the week. If you wish to assign certain users to a particular partition at all times, you must use a default Time-Of-Day Routing Plan that points to the same PGN # at all times.

- Uniform Dial Plan

Since UDP calls expand the dialed digits into 7-digit numbers and then use AAR to route the call, these calls use partitioning. Once the call is handled by AAR, the caller's COR is used to select the PGN for the call.

## Facility Restriction Levels and Traveling Class Marks

---

Facility Restriction Levels (FRL) and Traveling Class Marks (TCM) allow certain calls to specific users, while denying the same calls to other users. For example, certain users may be allowed to use central office (CO) trunks to other corporate locations while other users may be restricted to less expensive private-network lines.

FRLs and TCMs provide up to 8 levels of restriction for users of AAR and ARS.

### How to administer FRLs and TCMs

---

#### Required forms

| Form                 | Field       | Page                 |
|----------------------|-------------|----------------------|
| Class of Restriction | ■ FRL       | <a href="#">5-72</a> |
| Route Pattern        | ■ FRL (0-7) | <a href="#">8-67</a> |

#### NOTE:

FRLs are important to system security. Assign the most restrictive (7) FRL consistent with the FRLs to be used on the COR form and the least restrictive (0) FRL on the Route Pattern form in order to help prevent unauthorized use of system features.

### Detailed description

---

FRLs and TCMs are transparent to the user. The appropriate values are predetermined and programmed into the system. Dialing procedures are unaffected.

Call routing for each call is determined by the dialed area code or office code (either public or private network) or by the administered dial string. Analysis of the called number yields a route pattern. More than one dialed string can point to the same pattern. Each route preference includes:

- Trunk group number
- Minimum FRL required to access the trunk group

Each facility, such as a trunk or voice terminal, that is capable of originating a call also has an associated FRL. Whether a call is allowed or not depends on 2 things: compatibility between FRLs and availability of an idle trunk.

Compatibility is determined by a comparison of the minimum FRL associated with the route preference and the originating-side FRL. Either can have a value of 0–7. Access to the associated trunk group is permitted if the originating-side FRL is greater than or equal to the minimum FRL of the preference. Note that lower originating-side FRLs can access to fewer routing preferences, whereas lower minimum FRLs on the Route Pattern permit greater access. Stated another way, a 0 originating-side FRL is the most restricted and a 7 is the least restricted. A 0 minimum FRL is the least restrictive, and a 7 is the most restrictive (when applied to the route pattern's FRL). Compatibility checking begins with the first-choice route (the first one in the pattern). Assuming that access is permitted, availability is checked; that is, is there an idle trunk in the group? If so, the call continues. If not, compatibility is checked on the next-choice route. The intercept treatment is not received unless all possible routes are inaccessible.

If the compatibility check fails on the next-choice or subsequent route, or if all accessible trunk groups are busy, the call may queue on the first routing preference or first compatible trunk group if trunk queueing is provided.

If the trunk group selected for a call is an intertandem tie-trunk group, then a TCM is outpulsed as the last digit. A TCM is equivalent to the originating-side FRL. At the next tandem switch, compatibility and availability checking are done, as before. In this case, the FRL assigned to the incoming intertandem tie-trunk group is used as the originating-side FRL (to compare with the minimum FRL). If it is sufficient, then the call continues and no comparison between the TCM and minimum FRL is made. If it is not sufficient, then the TCM is compared with the minimum FRL to see if the call is allowed to continue. If this fails to yield a route and if the TCM is higher than the tie-trunk FRL, then the TCM is used in another attempt to complete the call.

## Call-originating facilities

At a switch serving as the call-origination point, any of the following can be the originator of an ARS or AAR call:

- Voice terminal
- Remote Access user
- Attendant
- Incoming tie-trunk group from a subtending location
- Data terminal capable of keyboard dialing

At a tandem switch, either of the following can be the originator of an ARS or AAR call:

- Incoming intertandem tie-trunk group
- Incoming access tie-trunk group — links a remote main switch to a tandem switch

Each of these facilities is assigned an FRL via an associated COR, either directly or indirectly.

Voice terminals and all incoming tie-trunk groups use the FRL within the assigned COR. Attendants use the FRL within the COR assigned to the attendant group for extended calls. If Individual Attendant Access is assigned, the individual attendant's COR FRL is used. Data terminals use the FRL within the COR assigned to the associated data module.

Remote Access can be accessed via the following trunk groups: DID, ISDN, tie, dedicated CO, 800-service, or dedicated FX. The applicable originating FRL is contained in the COR assigned to the dialed barrier code. If a barrier code is not required on remote access calls, the applicable FRL is the default (none).

## **Call terminating facilities**

Any of the following trunk types can serve as the termination point for an ARS or AAR call:

- Tie trunk — excluding Release Link Trunks (RLT), but including Common Control Switching Arrangement (CCSA) and Enhanced Private Switched Communications Services (EPSCS) access trunks
- Wide Area Telecommunications Service (WATS)
- CO
- Foreign exchange (FX)
- Integrated Services Digital Network - Primary Rate Interface (ISDN-PRI)

Each of these outgoing trunk groups has an assigned COR that contains an FRL. However, this FRL is never used. Terminating-side FRLs are assigned in the route pattern, not to the outgoing trunk group.

## **Considerations**

---

- FRLs restrict certain users from placing selected calls while allowing other users to place the same calls.
- A COR is assigned to each trunk group. If the COR specifies an FRL, the FRL is ignored. The minimum FRL specified in the route pattern is the only FRL used on the terminating side of the call.
- On attendant-extended calls, the attendant-group FRL is used rather than the FRL of the calling party.



## Guidelines and examples

The following guidelines and examples illustrate some practical aspects of FRLs.

FRLs on the terminating end of a call are not checked unless the terminating facility is a trunk group in a route pattern. This simplifies assignments. At each switch, the trunk groups available to handle a given AAR or ARS call can be listed in any order within the route pattern. Access to each listed trunk group must be determined via an FRL. On a scale of 0–7, the relative value is determined and assigned. Decisions are normally based on the cost, or appropriateness, of using the facility. The same FRL value can be assigned to more than one trunk group if there is no reason to prefer one trunk group over another.

If some users within the system are not allowed to make outside calls, use some value other than 0 for the first-choice route. Then assign these users an FRL of 0 to deny access to any trunk group, because all trunk-group FRLs are greater than 0.

Each route pattern must be individually constructed. The same trunk group can be used in more than one pattern. The associated FRL is assigned within the pattern and is not associated with the trunk group itself. The same trunk group can have a different FRL in a different pattern.

Be consistent in FRL assignments. Do not use a range of 0–5 in one pattern and 2–7 in another pattern if all users can access the first-choice route. Admittedly, the trunk group with an FRL of 2 may be more expensive than the trunk group with an FRL of 0, but there is no reason to assign 2 to a trunk group that everyone can access. For ease of assignments, always use 0 for such a trunk group.

Establish COR for each FRL in a route pattern. Assign the appropriate COR to users who can access the routes restricted by the FRL. For example, a middle executive might be able to access all routes with an FRL of 5 or lower, whereas the president can access all routes. In this case, the executive is assigned a COR with an FRL of 5 and the president is assigned a COR with an FRL of 7.

Remote access users can access system features and services the same as an on-premises user. FRL assignment is via remote-access barrier codes. Up to 10 barrier codes, each with its own COR (and FRL), can be assigned. Although the COR defines other restrictions, 10 barrier codes are enough to provide a range of FRL assignments. Assign barrier code FRLs as if the user were on-premises. The simplest way to assign these FRLs is to duplicate the on-premises FRLs, then relate the appropriate barrier code to users who need remote access.

The following is an example of how FRLs can be assigned in a COR:

- FRL0 — 911 access only
- FRL1 — Local calls only
- FRL2 — FRL1 plus home area-code calls using WATS
- FRL3 — FRL2 plus use of local lines for all calls in the home area code
- FRL4 — FRL3 plus calls to all the USA, using WATS only
- FRL5 — FRL4 plus calls to all the USA, using local lines
- FRL6 — FRL5 plus international calls
- FRL7 — Reserved

## **Interactions**

---

- AAR and ARS  
FRLs apply only on ARS and AAR calls (including Uniform Dial Plan).
- Authorization Codes  
Authorizations Codes can be used to raise a user's FRL.
- Call Detail Recording  
If 15-digit CDR account codes are used, the FRL field in the CDR record is overwritten.
- Intercept Treatment  
The TCM containing the originating facility's FRL is sent over ISDN facilities in the SETUP message.

## Alternate Facility Restriction Levels

---

Alternate Facility Restriction Levels (AFRL) allows DEFINITY ECS to adjust facility restriction levels or authorization codes for lines or trunks. Each line or trunk is normally assigned an FRL. With this feature, alternate FRLs are also assigned. Attendants or System Administrators can change to the alternates, thus changing access to lines and trunks. For example, a company might want to use this feature to disable most long-distance calling at night to prevent unauthorized staff from making long-distance calls.

### CAUTION:

*AFRL impacts AAR and ARS call routing because it may change the routing preferences. Using AFRL on tandem and tie-trunk applications affects entire networks. Calls that may be part of a cross-country private network may be blocked.*

## How to administer AFRL

---

### Required forms

---

| Form                                 | Field                        | Page                 |
|--------------------------------------|------------------------------|----------------------|
| Alternate Facility Restriction Level | ■ Current Status             | <a href="#">8-29</a> |
|                                      | ■ Alternate FRL              |                      |
| Station                              | ■ Feature Button Assignments | <a href="#">6-28</a> |
| Attendant Console                    | ■ Feature Button Assignments | <a href="#">5-35</a> |

## Detailed description

---

AFRLs affect two types of users: the attendant or System Administrator (who enables and disables the AFRL feature) and a voice-terminal user (who places outgoing trunk calls).

## Attendant perspective

You can administer an ALT-FRL button to any attendant console or any station. Pressing the ALT-FRL button activates or deactivates AFRL. Pressing the ALT-FRL button on any console or station may affect the status of other buttons.

When AFRL is activate, the user may notice a sudden change in calling privileges. For example, the user may have been able to make long-distance calls but AFRL (which have been administered to add restrictions to the calling

parties) can no longer do so. When AFRL is active, you can be any one of 3 types of alterable FRL entities:

- An originating line
- An originating trunk (for example, an incoming trunk call)
- A dialed authorization code

### Terminal-user perspective

If you use AFRL to restrict calling at certain hours, make sure that users know about those restrictions.

### Trunk originator case

In this case, the originator is in reality an incoming trunk. Incoming trunk calls can be direct inward dialing (DID) calls to a station, incoming calls on access tie-trunks, or possibly intertandem tie-trunk calls. The FRL of the device is first used to determine if it is at a high enough level to select the outgoing device. If it is not, then the FRL associated with this signaling entity, called a Traveling Class Mark (TCM), is used. Tandem trunk groups are administered to pass along the FRL level associated with the other switch as part of the interoffice signaling protocol. This can be done inband as part of the addressing information which is sent between two switches using tone sending on the trunk itself, or can be done using special ISDN Q.931 messaging. In either case, the seizure of the outgoing trunk is not done until either the TCM is received or (in the case of inband signaling) an interdigit timeout occurs while waiting for the TCM digit.

If AFRLs are active, the FRL associated with the incoming trunk group is set to a new FRL. If after doing so, the originator is blocked from the trunk facility due to insufficient FRL, the TCM, if any, is used. The TCM, which is in reality just another FRL, is also set to a new FRL value. Therefore, the TCM information recorded in the billing data (CDR) is the AFRL value, not the original TCM.

Due to the application of AFRL on tandem and tie trunk applications, entire networks can be affected by the application of the AFRL feature. Use caution to engineer AFRLs as *now calls* that may be part of a cross-country switch network and that may be blocked from completion due to the engineering of a restrictive AFRL arrangement.

### Considerations

---

- Consider the impact on your operations when there are sudden changes in the calling privileges of your system users. Consider announcing changes and preparing your telecommunications department to handle inquiries.

## Guidelines and examples

The following examples should help you understand AFRLs and should illustrate some of their practical aspects.

### AFRL mapping

FRLs are used to determine the privileges that an originating party can have when making an outgoing trunk call. This party can be either a line or a trunk. An FRL is assigned to each device and/or device group through its associate COR.

When a device originates an outgoing trunk call, its FRL is compared to the FRL of either the terminating trunk group or (for AAR or ARS) the preference. If the FRL of the originator is greater than or equal to the terminating FRL, the call proceeds. Otherwise, the call is blocked. FRLs restrict outgoing calls by destination, by time of day, or by facility problem (such as trunk outages).

For example, a technician could remap FRLs less than 3 to 3 and FRLs greater than 3 to 7. Any attendant or station with an AFRL button can control whether the original FRL or the AFRL is used.

### Authorization codes

Authorization codes prevent unauthorized access to various facilities. You can use them, for example, to restrict access to certain trunk groups or to remote access trunk groups. When a user dials an authorization code, it is validated by the system. If it is not valid, the call routes to an assignable intercept. If the code is valid, the system determines an associated COR. This COR has an FRL associated with it. If AFRL is activated, it is the AFRL level and not the FRL that is used in mapping the AFRL.

For example, a user whose FRL is 1 attempts a toll call. AFRL is active and maps as shown in [Figure 8-2](#) (that is, FRL = 1 maps to AFRL=3). The desired trunk has an FRL of 7, and so the user is blocked. If Authorization Codes are enabled, the user is prompted to dial an authorization code to obtain greater calling privileges. As shown in [Figure 8-2](#), an Auth Code set to 1234567 has a COR set to 3 and, therefore, an FRL set to 5. This is still not high enough to permit access to the desired trunk except when the user presses the active AFRL button. Then the AFRL feature is active and maps the FRL of 5 to 7, thus allowing the call to complete.

| Authorization code to COR Table |     | COR to FRL Table |     | FRL to AFRL Table |      |
|---------------------------------|-----|------------------|-----|-------------------|------|
| Authorization Code              | COR | COR              | FRL | FRL               | AFRL |
| 1234567                         | 3   | 1                | 1   | 0                 | 3    |
| 1234568                         | 2   | 2                | 3   | 1                 | 3    |
| 1234569                         | 3   | 3                | 5   | 2                 | 3    |
| 2222222                         | 3   | 4                | 7   | 3                 | 3    |
|                                 |     |                  |     | 4                 | 7    |
|                                 |     |                  |     | 5                 | 7    |
|                                 |     |                  |     | 6                 | 7    |
|                                 |     |                  |     | 7                 | 7    |

Originator COR is 1  
 Trunk Desired COR is 4

Figure 8-2. Example of authorization codes with AFRLs

### Interactions

- AAR/ARS
  - ARFL can change route preferences and affect the cost of usage-sensitive calls.
- Facility Restriction Levels and Traveling Class Marks
  - AFRL sets up alternate levels to those normally provided by FRL.

## Generalized Route Selection

---

Generalized Route Selection (GRS) provides voice and data call-routing capabilities. You use it to select not only the least-cost routing, but also the most optimal routing over the appropriate facilities.

GRS is a capability built onto the AAR and ARS features. In AAR or ARS, routing is based on the dialed number, the FRL of the caller, the partition group number, and the time of day. GRS provides additional parameters in the routing decision. It enhances AAR and ARS and maximizes the chance of using the right facility to route the call. Also, if an endpoint incompatibility exists, it provides a conversion resource (such as a modem from a modem pool) to attempt to match the right facility with the right endpoint.

### How to administer GRS

---

#### Required forms

---

| Form          | Field             | Page                  |
|---------------|-------------------|-----------------------|
| Route Pattern | ■ IXC             | <a href="#">8-67</a>  |
|               | ■ BCC             |                       |
|               | ■ ITC             |                       |
|               | ■ BCIE            |                       |
|               | ■ Service/Feature |                       |
|               | ■ Band            |                       |
| Trunk Group   | ■ BCC             |                       |
| Access        |                   | <a href="#">7-150</a> |
| CO            |                   | <a href="#">7-168</a> |
| FX            |                   | <a href="#">7-193</a> |
| Tandem        |                   | <a href="#">7-257</a> |
| Tie           |                   | <a href="#">7-262</a> |

---

### Detailed description

---

GRS allows customers to use separate routes for voice and data calls. For data calls, DEFINITY ECS distinguishes between restricted and unrestricted digital transmissions. This allows the switch to route data calls onto the appropriate facilities. With GRS, you can integrate voice and data on the same trunk group.

GRS allows the system to use the ISDN Call-by-Call Service Selection feature to access public network services. It also provides interworking between ISDN and non-ISDN entities.

ISDN interworking is the mixture of ISDN trunks and non-ISDN trunks in a call. A mixture of these signaling procedures is required to provide end-to-end connectivity when different type trunking facilities are used.

ISDN services add 5 routing parameters that are specified on each trunk group preference of the route pattern. These parameters are:

- Bearer Capability Class (BCC) — Identifies the type of call, such as voice calls and different types of data calls. For all trunk groups, the BCC is checked to see if the route selected is compatible.
- Information Transfer Capability (ITC) — Identifies the type of data transmission (restricted, unrestricted, or both). For all trunk groups, the ITC is checked to see if the route selected is compatible.
- Network Specific Facility — Identifies the services and features to be used to complete a call.
- Band — Identifies the OUTWATS band (US only). WATS is a voice-grade service providing both voice and low-speed data transmission calls to defined areas (bands) for a flat rate charge.
- Inter-Exchange Carrier (IXC) — Identifies the specific common carrier, such as AT&T, to be used for a call.

In GRS, there are 5 BCCs. Customers may specify routing for each BCC according to their particular transmission needs. See the Expanded Technical Information portion of this section for more information on BCCs and ISDN BCC Parameters.

## Expanded technical information on BCC

### BCCs

BCCs are the mechanisms by which specialized routing is provided for the various type data calls and voice calls. Each trunk group preference in the AAR or ARS route patterns contains a BCC parameter. When a call is originated, a route is selected based on the BCC of the originating facility. BCCs are used to classify the type of traffic permitted on this trunk in the outgoing direction. Details on how a trunk group preference is determined are given in Guidelines and examples.

A set of ISDN bearer capability and low-layer compatibility parameters are defined by a BCC.



The system will determine the originating endpoint's BCC from one of the following:

- For an ISDN-BRI set, the switch determines the BCC by using information from the Bearer Capability Information Element (IE) and Low-Layer Compatibility IE in the ISDN SETUP message.
- For a non-BRI terminal, the switch creates a BCC by using information about the station administration for the terminal and information obtained by performing a terminal query.
- From the administered value of the incoming trunk. For a non-ISDN trunk group, the switch uses the administered BCC value.
- From the ISDN bearer capability and low-layer compatibility parameters, if the call is an ISDN trunk-originated call.

The BCC associated with the routing preference in the route pattern is administered by the system administrator. More than one BCC can be associated with each preference and the same facility can appear multiple times in a route pattern and in multiple route patterns.

The BCC of the originating endpoint (trunk or terminal) is matched with the BCCs of the routing preferences. An exact match is not always required. The system determines when conversion/insertion resources must be used to successfully complete a call via a compatible, but not identical, BCC.

GRS recognizes one or more of 5 BCCs for each trunk group preference in the route pattern (DCP/DMI mode is explained later). See [Table 8-4](#).

**Table 8-4. BCC Assignment**

| Endpoint                         | Voice/<br>Data Mode | BCC   | Comments                             |
|----------------------------------|---------------------|-------|--------------------------------------|
| Voice Terminal                   | Voice               | 0     |                                      |
| Data Line Circuit Pack           | 2                   | 2     |                                      |
| Voice Data Set                   | 2                   | 2     |                                      |
| Modular Processor Data Module    | 0,1,2               | 1,2,4 | See Note                             |
| Modular Processor Data Module-M1 | 1                   | 1     | For ACCUNET Switched 56 kbps Service |
| Modular Trunk Data Module        | 2                   | 2     |                                      |
| Digital Terminal Data Module     | 2                   | 2     |                                      |

*Continued on next page*

**Table 8-4. BCC Assignment — Continued**

| Endpoint                                  | Voice/<br>Data Mode | BCC   | Comments |
|---|---------------------|-------|----------|
| 510D Personal Terminal                    | 2                   | 2     |          |
| Digital Communications Protocol Interface | 0,2,3               | 2,3,4 | See Note |
| 7400A Data Module                         | 2                   | 2     |          |
| 3270T Data Module                         | 3                   | 3     |          |
| 3270C Data Module                         | 3                   | 3     |          |
| 3270A Data Module                         | 2,3                 | 2,3   | See Note |

**Legend**

| BCC | Type                       | DCP/DMI Mode |
|-----|----------------------------|--------------|
| 0   | Voice-Grade Data and Voice | None         |
| 1   | 56 kbps Data (Mode 1)      | 1            |
| 2   | 64 kbps Data (Mode 2)      | 2            |
| 3   | 64 kbps Data (Mode 3)      | 3            |
| 4   | 64 kbps Data (Mode 0)      | 0            |

 **NOTE:**

For all endpoints, the switch automatically determines its current operating mode when the data module originates. Before any call is originated, the default is Mode 2.

Since call origination from a data module determines the mode used on the call, you should press the Originate/Disconnect button once after changing data options. This way, the right mode is sure to be assigned to the next call.

## ISDN BCC parameters

The ISDN BCC Parameters are:

- Information Transfer Capability
- Low-Layer Compatibility
- DCP/DMI Mode

### Information Transfer Capability

The information to be transferred (or type of call) requires different transmission facilities. For example, transmission needs for voice calls and data calls are generally different. Voice and voice-grade data calls can be sent over analog trunks, while high speed data calls require digital trunks.

The Information Transfer Capability parameter in the Bearer Capability Information Element (BC IE) and Low-Layer Compatibility Information Element (LLC IE) have the following 4 values:

- Voice (speech)
- Voice-grade data (3.1 kHz transmission)
- Unrestricted digital transmission
- Restricted digital transmission.

With data calls, the switch distinguishes the information transfer capability (restricted or unrestricted) of the originating data endpoint (trunk or terminal). It uses the information transfer capability of the data endpoint to route the call to the appropriate facility. For BRI and PRI originating data endpoints, the information transfer capability is contained in the ISDN SETUP message. For non-ISDN data endpoints, the switch uses the information transfer capability specified by the system administrator. The default for the information transfer capability of an endpoint is *restricted*. This can be changed to restricted or unrestricted for each non-ISDN originating endpoint.

More than one Information Transfer Capability can be supported by one BCC. See [Table 8-5](#).

**Table 8-5. Assignment of BCC Based on Information Transfer Capability**

| DCP/DMI MODE    | Information Transfer Capability     | BCC | Comments   |
|-----------------|-------------------------------------|-----|--|
| —               | Speech, 3.1 kHz                     | 0   | Used for Voice/ Voice Grade Data.                          |
| M1              | Unrestricted/<br>Restricted Digital | 1   | Used for Mode 1 Data (56 kbps).                            |
| M2 <sup>1</sup> | Unrestricted/<br>Restricted Digital | 2   | Used for Mode 2 Data (async data speed up to 19.2 kbps).   |
| M3 <sup>1</sup> | Unrestricted/<br>Restricted Digital | 3   | Used for Mode 3 Data (64 kbps).                            |
| M0              | Unrestricted/<br>Restricted Digital | 4   | Used for Mode 0 Data <sup>2</sup> (64 kbps clear channel). |

1. Typically not used outside of North America.
2. Use BCC 4 for an unknown data mode that requires a 64-KBPS channel.

### Low-Layer Compatibility

The low-layer compatibility information element provides remote compatibility checking. This element is used with the bearer capability element and determines the mode of the originating caller. The low-layer compatibility information element is optional and sent only in case of data calls.

 **NOTE:**  
 DCP Mode 0 does not send an LLC IE.

### DCP/DMI Mode

The Digital Communications Protocol (DCP) and the Digital Multiplexed Interface (DMI) modes are data parameters of the originating data facility. These modes are not applicable to voice.

The mode values (0, 1, 2, and 3) are administered for data and Alternate Voice/Data (AVD) non-ISDN trunk groups. These mode values determine the BCC of the trunk groups.

### Determination of BCC at tandeming or terminating system

The BCC parameters received on the signaling channel (D-channel) determine the BCC for an incoming call from an ISDN trunk to a tandem or terminating switch. This includes the ITC (restricted or unrestricted) if the call is a data call.

The BCC for an incoming call from a non-ISDN trunk is determined as follows:

- If the incoming trunk is a voice trunk, then the BCC is defaulted to 0.
- If the incoming trunk is a data, AVD, or RBAVD (robbed-bit AVD) trunk, then the BCC and ITC are administrable.

## Guidelines and examples

---

The AAR/ARS route pattern contains an indication for each trunk group preference showing which BCC or BCCs can use that trunk group. A trunk group preference may have more than one BCC.

GRS uses a *look-ahead* algorithm when determining which preference in a route pattern to choose. GRS first attempts to find an exact match between the originator's BCC and the corresponding allowed BCC for any of the preferences in the route pattern. Therefore, if preference 1 does not have an exact match (even though there are available compatible members in preference 1), it is skipped over if a subsequent preference in the same pattern has an allowed BCC that exactly matches the originator's BCC.

After matching the BCCs, DEFINITY ECS matches the ITCs. The originator's ITC is matched to the route preference ITC.

- Unrestricted (unre) matches on "unr" or "both"
- Restricted (rest) matches on "rest" or "both"

### NOTE:

ITC matching only applies to data calls (BCC 1 through 4).

As an example of how GRS chooses a trunk group preference, assume preference 1 in a pattern has BCC 0 and BCC 2 set to yes, while preference 2 has BCC 1, BCC 3, and BCC 4 set to yes. A voice or Mode 2 data call accessing this pattern uses the first preference, while a Mode 1, Mode 3, or Mode 0 data call uses the second. (This is independent of the availability of trunks in the first preference.)

When an exact match is not found in any of the route-pattern preferences, calls are treated as follows:

- Calls With an Originating BCC of 0

A BCC 0-originated call (such as voice or analog modem) is not denied routing by GRS, even if the route pattern lacks a preference with BCC 0 set to yes. This allows you to use voice transfer to data when making a data call, without the need for data preindication.

- If a BCC 0-originated call accesses a route pattern for which there is no preference for BCC 0 set to yes, then GRS chooses a preference with BCC 2 set to yes (if one exists).

- If none exists, the next preferred order would be a preference with BCC 1 set to yes, followed by BCC 3, and finally, BCC 4.

Since each preference must allow at least one BCC to be passed, a BCC 0 (voice) originated call is never blocked by GRS. The call is of course still subject to other restrictions, such as FRL restrictions. The ITC does not help select a preference.

Since BCC 0 (voice) has no ITC, the switch selects an ITC from the route pattern when a BCC 0 call is being routed as a data call. [Table 8-6](#) shows how the ITC codepoint in the Bearer Capability IE is determined.

**Table 8-6. Determination of ITC Codepoint**

| Originating Endpoint's ITC | Routing Preference's ITC |              |               |                   | ITC codepoint in BC IE |
|----------------------------|--------------------------|--------------|---------------|-------------------|------------------------|
|                            | restricted               | unrestricted | both endpoint | both unrestricted |                        |
| voice                      | x                        |              |               |                   | restricted             |
| voice                      |                          | x            |               |                   | unrestricted           |
| voice                      |                          |              | x             |                   | unrestricted           |
| voice                      |                          |              |               | x                 | unrestricted           |

- Calls With an Originating BCC of 2
  - If a BCC 2 originated call accesses a route pattern for which no preference has BCC 2 set to yes, then GRS chooses a preference with BCC 0 set to yes (if one exists).
  - If none exists, the call is blocked with intercept treatment.

- Calls With an Originating BCC of 1, 3, or 4
 

A DCP/DMI Mode 0 (BCC 4), Mode 1 (BCC 1), or Mode 3 (BCC 3) originated call requires an exact match on at least one preference in a route pattern in order for GRS to allow the call to complete.

For example, a Mode 1 originated call completes only if the accessed route pattern has a preference with BCC 1 set to yes. The ITCs must also match.

When an ISDN trunk group preference is accessed, the BCC information is encoded and sent in the outgoing ISDN SETUP message to the distant-end as shown below. The BCC information sent to the far-end is important. The BCC information that the far-end receives in the SETUP message becomes the originating BCC for the far-end's incoming trunk call.

- If an exact match of the originator's BCC and ITC is found, then that Bearer Capability is encoded and sent in the ISDN SETUP message to the far-end. If the call is a data call, the system uses the ITC of the route pattern to encode the SETUP message as shown in [Table 8-7](#).

Table 8-7. Encoding of Setup message

| Originating Endpoint's ITC | Routing Preference's ITC |              |               |                   | ITC codepoint in BC IE |
|----------------------------|--------------------------|--------------|---------------|-------------------|------------------------|
|                            | restricted               | unrestricted | both endpoint | both unrestricted |                        |
| restricted                 | x                        |              |               |                   | restricted             |
| restricted                 |                          |              | x             |                   | restricted             |
| restricted                 |                          |              |               | x                 | unrestricted           |
| unrestricted               |                          | x            |               |                   | unrestricted           |
| unrestricted               |                          |              | x             |                   | unrestricted           |
| unrestricted               |                          |              |               | x                 | unrestricted           |
| voice <sup>1</sup>         | x                        |              |               |                   | restricted             |
| voice                      |                          | x            |               |                   | unrestricted           |
| voice                      |                          |              | x             |                   | unrestricted           |
| voice                      |                          |              |               | x                 | unrestricted           |

1. A voice originated call without data preindication that is routed to a route pattern with data preferences only.

- If an exact match is not found, but the call is allowed to proceed, then the BCC encoded in the SETUP message sent to the far-end is that of the route pattern.

For example, if a BCC 2 (for example, DTMF) endpoint originates a call and accesses a pattern that has one preference with only BCC 0 set to yes, then the switch automatically inserts a modem pool for this call. In effect, the modem pool is converting BCC 2 to BCC 0. The far-end cannot distinguish this call from a BCC 0-originated call that has no modem pool inserted. Therefore, BCC 0 is sent in the SETUP message. This may in turn determine routing decisions by the far-end. Additional routing decisions are made as shown in [Table 8-8](#) through [Table 8-12](#).

## BCC and ITC Determination on Calls from Endpoints to ISDN Trunks

Table 8-8. Calls from Endpoint to ISDN Trunks

| Originating BCC | Chosen BCC from the Route Pattern |       |       |       |       |
|-----------------|-----------------------------------|-------|-------|-------|-------|
|                 | BCC 0                             | BCC 1 | BCC 2 | BCC 3 | BCC 4 |
| BCC 0           | P                                 | PT    | PT    | PT    | PT    |
| BCC 1           | B                                 | P     | B     | B     | B     |
| BCC 2           | PM                                | B     | P     | B     | B     |
| BCC 3           | B                                 | B     | B     | P     | B     |
| BCC 4           | B                                 | B     | B     | B     | P     |

Legend

|    |  |
|----|--|
| B  | Block the call with intercept treatment  |
| P  | Allow the call and send the originating endpoint's BCC in the SETUP message. Use the ITC as shown in <a href="#">Table 8-9</a> |
| PT | Allow the call and send the BCC and ITC chosen from the route pattern in the SETUP message                                     |
| PM | Insert a pooled modem for the call and send the BCC and ITC chosen from the route pattern in the SETUP message                 |

If BCC 1, 2, 3, or 4 is chosen from [Table 8-8](#), [Table 8-9](#) is used to determine the appropriate ITC.

Table 8-9. Calls from Endpoints to ISDN Trunks

| Originating ITC | Chosen ITC from the Route Pattern |      |            |          |
|-----------------|-----------------------------------|------|------------|----------|
|                 | unr                               | rest | both endpt | both unr |
| unr             | P                                 | B    | P          | PU       |
| rest            | B                                 | P    | P          | PU       |

Legend

|    |   |
|----|---|
| B  | Block the call with intercept treatment                                     |
| P  | Allow the call and send the originating endpoint's ITC in the SETUP message |
| PU | Allow the call and send unrestricted in the SETUP message                   |



## BCC and ITC Determination on Calls from Trunks to ISDN

Table 8-10. Calls from Trunks to ISDN Trunks

| Originating BCC | Chosen BCC from the Route Pattern |       |       |       |       |
|-----------------|-----------------------------------|-------|-------|-------|-------|
|                 | BCC 0                             | BCC 1 | BCC 2 | BCC 3 | BCC 4 |
| BCC 0           | P                                 | PT    | PT    | PT    | PT    |
| BCC 1           | B                                 | P     | B     | B     | B     |
| BCC 2           | PT                                | B     | P     | B     | B     |
| BCC 3           | B                                 | B     | B     | P     | B     |
| BCC 4           | B                                 | B     | B     | B     | P     |

Legend

|    |   |
|----|---|
| B  | Block the call with intercept treatment   |
| P  | Allow the call and send the incoming trunk's BCC in the SETUP message. Use the ITC as shown in <a href="#">Table 8-11</a> |
| PT | Allow the call and send the BCC and ITC chosen from the route pattern in the SETUP message                                |

If BCC 1, 2, 3, or 4 is chosen from [Table 8-10](#), [Table 8-11](#) is used to determine the appropriate ITC.

Table 8-11. Calls from Trunks to ISDN Trunks

| Originating | Chosen ITC from the Route Pattern |      |            |          |
|-------------|-----------------------------------|------|------------|----------|
|             | unr                               | rest | both endpt | both unr |
| unr         | P                                 | B    | P          | PU       |
| rest        | B                                 | P    | P          | PU       |

Legend

|    |   |
|----|---|
| B  | Block the call with intercept treatment                               |
| P  | Allow the call and send the incoming trunk's ITC in the SETUP message |
| PU | Allow the call and send unrestricted in the SETUP message             |

The system does not insert pooled modem for any interworking trunk-to-ISDN trunk calls. The BCC and ITC of an incoming trunk are determined as follows:

- ISDN Trunk BCC and ITC are in the received SETUP message
- AVD Trunk BCC and ITC are the BCC and ITC values administered on the trunk group form
- RBAVD Trunk BCC and ITC are the BCC and ITC values administered on the trunk group form
- Data Trunk BCC and ITC are the BCC and ITC values administered on the trunk group form
- Voice Trunk BCC is 0.

### BCC and ITC Determination on Calls from ISDN Trunks to Endpoints (GRS not Involved)

Table 8-12. Calls from ISDN Trunks to Endpoints

| Originating BCC | Terminating Endpoint BCC |       |       |       |       |
|-----------------|--------------------------|-------|-------|-------|-------|
|                 | BCC 0                    | BCC 1 | BCC 2 | BCC 3 | BCC 4 |
| BCC 0           | P                        | P     | PM    | P     | P     |
| BCC 1           | P                        | P     | P     | P     | P     |
| BCC 2           | P                        | P     | P     | P     | P     |
| BCC 3           | P                        | P     | P     | P     | P     |
| BCC 4           | P                        | P     | P     | P     | P     |

Legend

|    |  |
|----|--|
| P  | Allow the call, and (1) if it is a voice originated call, let the calling user decide whether the terminating endpoint is the correct endpoint or not based on audible feedback (for example, data tone), or (2) if it is a data call, the data handshake procedure will establish or drop the call based on the compatibility of the endpoints. |
| PM | Insert a pooled modem and terminate the call to the endpoint. The ITC defaults to restricted in this case.   |



**NOTE:**

The system does not use ITCs when terminating to an endpoint.

## Look-Ahead Routing

---

Look-Ahead Routing (LAR) provides an efficient way to use trunking facilities. It allows you to continue to try to reroute an outgoing ISDN call that is not completing. When DEFINITY ECS receives a cause value that indicates congestion, LAR tells the system what to do next. For each routing preference, you can indicate if the next routing preference should be attempted or if the current routing preference should be attempted a second time. If the second attempt fails, the next routing preference is attempted.

LAR can be administered at either an origination switch or a tandem switch. However, it also can be turned off at different points in the network to reduce network load. You use LAR with AAR and ARS, GRS, UDP. You can also use it with the Feature Access Code ISDN Access Code. A LAR field is administered on the Route Pattern form.

### How to administer LAR

---

#### Required forms

---

| Form          | Field | Page                 |
|---------------|-------|----------------------|
| Route Pattern | ■ LAR | <a href="#">8-67</a> |

#### NOTE:

When LAR is used in a mixed network of DEFINITY ECS and pre-DEFINITY ECS switches, LAR ends at the pre-DEFINITY ECS switch and calls are rejected the normal way. However, if a LAR-triggering cause value is passed back in the network to a DEFINITY ECS that is enabled for LAR, LAR is attempted from that switch again.

### Detailed description

---

LAR can be administered for each ISDN route preference per Pattern Number. The maximum number of LAR attempts per call per switch is 2 times the number of route preferences in the route pattern. LAR can be administered at each intermediate node that the call may be tandemed through to allow all possible routes to be attempted. You can control LAR by:

- Administering it on a per route-preference basis
- Partitioning trunks
- Limiting the number of hop counts

## LAR activation

LAR is active when a call is rejected with a cause value in the range of #34–#47 and #3 (no route to destination). The range of #34–#47 indicates congestion and that resources are unavailable. The following cause values activate LAR:

| Cause Value | Cause Description                            |
|-------------|--|
| 3           | ■ No route to destination                    |
| 34          | ■ No circuit/channel available               |
| 38          | ■ Network out of order                       |
| 41          | ■ Temporary failure                          |
| 42          | ■ Switching equipment congestion             |
| 43          | ■ Access information discarded               |
| 44          | ■ Requested circuit or channel not available |
| 47          | ■ Resources unavailable                      |

### ⇒ NOTE:

When country code 13, protocol version a, is administered on the DS1 Circuit Pack form, only the cause values #10 and #89 activate LAR.

## LAR termination

LAR terminates when:

- Call is successfully routed
- Call is rejected with a non-LAR-triggering cause value
- No further route preference can be used to route the call

## LAR measurement

You can measure the number of LAR reroutes that are attempted and successful. A new form, Measurements LAR Route Pattern, displays LAR measurements for a particular route pattern. A route pattern must be selected for measurement before data collection. See *DEFINITY Enterprise Communications Server Release 6 System Monitoring and Reporting* for more information.

## Considerations

---

- LAR cannot be activated by dialing an ISDN TAC or via Extended Trunk Access (ETA).
- If LAR is enabled for an ISDN-PRI route preference and AAR, ARS, GRS, or ISDN Access Code is used, LAR can be active on all outgoing calls using that route preference. This includes: Abbreviated Dialing, ACCUNET

Service, Administered Connections, Call-by-Call Service Selection, Call Forwarding, Call Vectoring, Electronic Tandem Networks, Multimedia, Outgoing Call Management, and QSIG Networks.

## Interactions

---

- Automatic Circuit Assurance

LAR rerouting attempts are recorded as short holding time calls.
- Distributed Communications Systems

If a non-DCS trunk preference is selected for rerouting a DCS call, DCS feature transparency is lost. If LAR for a DCS call is done within the same DCS trunk group, feature transparency is not lost.
- Generalized Route Selection

LAR on a route preference does not change or impact GRS feature operation.
- QSIG Networks

If a non-Supplementary Services B (SS B) trunk preference is selected for rerouting a SS B call, QSIG feature transparency is lost. If LAR for a QSIG call is done through either the same or another SS B trunk group, feature transparency is not lost.
- Ringback Queuing

When a call originates and queues at the trunk group queue, the call can be placed in queue multiple times if LAR is active. The call originator can be called back each time the call is continued automatically.
- Satellite Hop Limit

Satellite Hop Limit always takes precedence over LAR. When the maximum hop limit is reached for a route preference, the last call routing attempt is denied and the call is rejected with a cause value of #28 — invalid number format. (This value does not activate LAR.)
- System Measurements

System resource use during LAR attempts are included in existing system measurements and performance reports. They include the following measurements: route pattern, call rate, call summary, performance summary, processor occupancy, trunk group, and call-by-call measurements. For more information about LAR system measurements, refer to *DEFINITY Enterprise Communications Server Release 6 System Monitoring and Reporting*.

## Subnet Trunking

---

Subnet Trunking modifies the number you dial so an AAR or ARS call can route over different trunk groups. These trunk groups frequently terminate in switches with different dial plans.

Subnet Trunking inserts digits, deletes digits, pauses, and/or waits for dial tone in digit outpulsing, as required, so calls route:

- To or through a remote switch
- Over Tie trunks to a private network switch
- Over CO trunks to the serving CO

Subnet Trunking is not required on calls terminating directly to a party at the local switch. AAR handles these calls.

Subnet Trunking is required on calls routing to or through a remote switch, regardless of the call's destination.

### How to administer Subnet Trunking

---

#### Required forms

---

| Form                              | Field                              | Page                  |
|-----------------------------------|------------------------------------|-----------------------|
| Route Pattern                     | ■ No. Del. Digits                  | <a href="#">8-67</a>  |
|                                   | ■ Inserted Digits                  |                       |
| Feature-Related System Parameters | ■ Off Premises Tone Detect Timeout | <a href="#">5-123</a> |
|                                   | ■ Interval                         |                       |

---

### Detailed description of Subnet Trunking

---

An AAR or ARS call may ultimately reach a point where it can no longer route on a private network. That is, the call reaches a point where another on-network switch is not available for the call. Assuming the call is not denied at this point, it routes to one of the following:

- Directly to a party at the local switch
- Directly to a WATS serving office
- Directly to a local CO or a FX CO

Calls accessing a local CO or FX CO directly from the terminating switch normally require Subnet Trunking only if access to a long-distance carrier is other than the carrier automatically provided by the CO. In this case, DEFINITY ECS inserts the appropriate dial access code into the digit string. Subnet Trunking is

needed only if the number is modified or if the call passes through some intermediate switch.

Subnet Trunking is used to provide added functionality to the system. For example, it can convert an AAR number into an international number. Also, it can modify a digit string so that a remote access trunk group can be used on calls.

ARS does not use Subnet Trunking to add or delete an area code; it handles it via code conversion.

AAR uses Subnet Trunking to convert an on-network number to a public network number. In this case, the conversion may include an Area Code insertion via Subnet Trunking.

Any of several special characters may be used with Subnet Trunking:

- Pause — Delays outpulsing of subsequent digits for 1.5 seconds
- Wait — Can be administered in one of two ways
  - In the first way, delays outpulsing of subsequent digits for a preprogrammed interval (from 5 to 25 seconds) or, if tone detectors are provided, until dial tone is received from the distant switch or the interval expires, whichever occurs first.
  - In the second way, dial tone must be received before any outpulsing is done.
- Convert-to-tone — Causes all remaining digits to be outpulsed using tone signaling.

## Time of Day Routing

---

Time of Day (TOD) Routing provides the most economical routing of ARS and AAR calls. This routing is based on the time of day and day of the week that each call is made. Up to 8 TOD routing plans may be administered, each scheduled to change up to 6 times a day for each day in the week.

With TOD Routing, you can take advantage of lower calling rates during specific times of the day and week. In addition, companies with locations in different time zones can use different locations that have lower rates at different times of the day or week. This feature is also used to change patterns during the times an office is closed in order to reduce or eliminate unauthorized calls.

### How to administer Time of Day Routing

---

#### Required forms

| Form                                  | Field   | Page                   |
|---------------------------------------|---|------------------------|
| Time of Day Routing Plan              | ■ All   | <a href="#">8-78</a>   |
| AAR and ARS Digit Analysis Table      | ■ All   | <a href="#">8-54</a>   |
| Node Number Routing (optional)        | ■ All   | <a href="#">12-119</a> |
| Class of Restriction                  | ■ Time of Day Plan Number   | <a href="#">5-72</a>   |
| Station (multi-appearance) (optional) | ■ Button/Feature Button Assignments<br>— man-overid<br>— clk-overid | <a href="#">6-28</a>   |
| Attendant Console (optional)          | ■ Feature Button Assignments<br>— man-overid<br>— clk-overid        | <a href="#">5-35</a>   |

- Time of Day Routing can only be used if AAR and ARS Partitioning and AAR or ARS are used. Also, it needs to be enabled on the System-Parameters Customer-Options form.

### Detailed description

---

TOD Routing uses the Time of Day Plan Number assigned by the COR feature. A Time of Day Routing Plan can be administered for each of the 8 Time of Day Plan Numbers. When you make an AAR or ARS call, the call is routed according to the Time of Day Routing Plan associated with your Time of Day Plan Number.

After a call passes through AAR or ARS Digit Conversion (with no matching pattern found) and toll analysis allows the call, the Time of Day Plan Number of the calling party is used to make the choice of an associated Time of Day



Routing form. A PGN is identified and AAR or ARS Partitioning selects the specific partition of the AAR or ARS Digit Analysis form and determines how the call is routed.

When TOD Routing is enabled, it applies to all AAR or ARS outgoing calls: voice terminals, attendants, data terminals, remote access users, incoming tie trunks, ISDN-PRI trunks, and trunks used for call forwarding to external numbers.

## Overriding the Time of Day Routing Plan

An attendant or a voice terminal user with console permission and a display can temporarily override the activating user's current routing plan. This can be accomplished by either of two methods:

- Immediate Manual Override
- Clocked Manual Override

Both types of override cannot be activated simultaneously. If either type is activated while the other is still in effect, the newly activated override goes into effect and the other override is automatically deactivated.

There is no indication via the management terminal that either type of override is activate. Also, since these overrides are temporary, they are not saved to translations.

## Guidelines and examples

Assume the following:

- Jim is the user at extension 1234.
- Extension 1234 is assigned a COR of 2.
- COR 2 is assigned a Time of Day Plan Number of 3.
- The Time of Day Routing Plan table for Time of Day Plan Number 3 is administered as shown in [Screen 8-1](#).

When Jim comes into work on Monday morning at 8:30 and at that time makes an ARS call (dials the ARS access code followed by the number of the person he is calling), the system looks at the Time of Day Plan Number assigned to Jim's COR to determine which Time of Day Routing Plan table is used.

Since Jim has a COR of 2 and COR 2 has a Time of Day Plan Number of 3, the system uses Time of Day Routing Plan 3 to route the call.

According to Time of Day Routing Plan 3, all calls made between 8:00 a.m. and 12:00 p.m. route according to the ARS Digit Analysis Table associated with PGN 2. Therefore, these tables are used to find a route pattern for the call.

If Jim makes a call between 12:00 p.m. and 1:00 p.m. on Monday, the same Time of Day Routing Plan table (number 3) is used and the call is routed according to PGN 1. See [Screen 8-1](#).

Page 1 of 1

TIME OF DAY ROUTING PLAN 3

| Act Time  | PGN # | Act Time   | PGN # | Act Time   | PGN # | Act Time   | PGN # | Act Time   | PGN # | Act Time |
|-----------|-------|------------|-------|------------|-------|------------|-------|------------|-------|----------|
| Sun 00:01 | 1     | __: __     | -     | __: __     | -     | __: __     | -     | __: __     | -     | __: __   |
| Mon 00:01 | 1     | __08: __00 | 2     | __12: __00 | 1     | __13: __00 | 2     | __17: __00 | 1     | __: __   |
| Tue 00:01 | 1     | __08: __00 | 2     | __12: __00 | 1     | __13: __00 | 2     | __17: __00 | 1     | __: __   |
| Wed 00:01 | 1     | __08: __00 | 2     | __12: __00 | 1     | __13: __00 | 2     | __17: __00 | 1     | __: __   |
| Thu 00:01 | 1     | __08: __00 | 2     | __12: __00 | 1     | __13: __00 | 2     | __17: __00 | 1     | __: __   |
| Fri 00:01 | 1     | __08: __00 | 2     | __12: __00 | 1     | __13: __00 | 2     | __17: __00 | 1     | __: __   |
| Sat 00:01 | 1     | __: __     | -     | __: __     | -     | __: __     | -     | __: __     | -     | __: __   |

Screen 8-1. Time of Day Routing Plan

## Interactions

- **Abbreviated Dialing**  
 For TOD Routing purposes, a user's own COR Time of Day Plan Number is used when accessing an Abbreviated Dialing privileged list. The call is processed the same as if the call had been dialed directly using AAR or ARS.
- **Attendant Extended Calls**  
 When an attendant extends a call and that call uses AAR or ARS to process the call, the call is routed according to the Time of Day Plan Number of the attendant's COR.
- **Authorization Codes**  
 If a user's FRL is changed using an Authorization Code, the COR FRL associated with the entered Authorization Code is used in route pattern selection.
- **AAR and ARS**  
 When Time of Day Routing is assigned, all AAR and ARS calls use the Time of Day Routing Plans for routing calls.
- **Bridged Call Appearance**  
 The COR Time of Day Plan Number of the primary extension applies to calls originated from a bridged call appearance of the primary extension.
- **Call Detail Recording**  
 Normal CDR records are generated. Information about the Time of Day Plan Number used to route the call is not provided.

- Call Forwarding

If you enable call forwarding and AAR or ARS routes an incoming call to the forwarded-to number, the COR Time of Day Plan Number of the caller is used to route the call.

- DCS

Care should be taken when making Time of Day Routing assignments in a DCS environment. Depending on a user's Time of Day Plan Number, a user may or may not be routed to a DCS trunk group. If a user is not routed to a DCS trunk group, feature transparency is lost.

When a call routes over a DCS trunk, the switch at the far end routes the call according to the COR Time of Day Plan Number of the incoming trunk.

- Individual Attendant Access

When an individual attendant access call is made, the individual attendant's COR Time of Day Plan Number is used for routing the call.

- Remote Access

When an AAR or ARS call is made via remote access, the COR Time of Day Plan Number of the barrier code and/or authorization code that was entered is used for routing the call.

- UDP

The caller's COR Time of Day Plan Number is used to route UDP calls.

This section contains the forms and associated instructions for implementing automatic routing. Included are:

- AAR and ARS Digit Analysis Table
- AAR and ARS Digit Conversion Table
- AAR and ARS Route Pattern form
- ARS Toll Table
- Remote Home Numbering Plan Area (RHNP) Table
- Time of Day Routing Plan

AAR and ARS are implemented using similar forms. When fields and their definitions are the same, they are not repeated. When they are different, the difference is noted. Examples of both forms are provided.

 **NOTE:**

For AAR administration, on the System-Parameters Customer-Options form, either the Private Networking or Uniform Dialing Plan option must be enabled.

For ARS administration, on the System-Parameters Customer-Options form, the Automatic Route Selection must be enabled as well as Time of Day Routing.

## **Automatic Routing Forms**

## AAR and ARS Digit Analysis Table

This form maps customer dialed strings to route patterns. When there is a Remote Home Numbering Plan Area (RHNPA) entry in `Rte Pat`, the RHNPA Table translates the next 3 digits.

If RHNPA translations are required for certain dialed strings, enter r1–r32 in the appropriate `Rte Pat` field on the AAR or ARS Digit Analysis Table. The RHNPA Table is used for translating 3-digit codes in the range 000–999. The RHNPA Table is used typically for the DDD of CO codes in a non-local NPA. For additional information, see [“RHNPA Table” on page 8-76](#).

### Administration commands

Use the following commands to administer the AAR and ARS Digit Analysis Table form.

| Action  | Object                               | Qualifier <sup>1</sup>  |
|---------|--------------------------------------|---|
| change  | aar analysis<br>ars analysis         | Enter digits between 0 to 9, 'x' or 'X' (dialed string) ['part' 1-8] ['min'(1-MAX)]   |
| display | aar analysis<br>ars analysis         | Enter digits between 0 to 9, 'x' or 'X' (dialed string) ['part' 1-8] ['min' (1-MAX)] ['print' or 'schedule']                                |
| list    | aar analysis<br>ars analysis         | ['start' string] ['count' 1-MAX] ['route'(1-MAX or r1-r32)], ['part' (1-8)], ['node' (1-MAX)], ['to-node' (1-MAX)], ['print' or 'schedule'] |
| list    | aar route-chosen<br>ars route-chosen | Enter dialed number, ['partition' (1-8)], ['print' or 'schedule']   |

- Some qualifiers are available with R5si and later configurations only. Brackets [] indicate the qualifier is optional. Single quotes ( ' ') indicate the text inside the quote must be entered exactly as shown or an abbreviated form of the word may be entered. MAX is the maximum number available in your system configuration.



- **Percent Full** — 3-character display-only field. Displays the percentage of the System's memory resources that have been used. A common pool of memory resources is shared between the ARS and AAR Analysis tables.  
  
 If this field display indicates that the System memory resources are in jeopardy of becoming full (100%), perform any of the following to free-up memory resources:
  - Delete unnecessary entries from any of the shared resources tables
  - Use RHNPA Tables for 6-digit screening. Use ARS analysis to screen on the area code. Then use the RHNPA Table to finish the 6-digit screening in the office code.
  - Reduce Dialed String field entries to shortest possible length that accomplishes the desired function.
- **Partitioned Group Number** — Enter the PGN to be associated with this table. Valid entries are 1 (default) to 8.
- **Dialed String** — Enter the dialed string of significant digits. Up to 18 ARS characters consisting of the digits 0 through 9 or \* are allowed. Use a wildcard letter (x or X) to substitute for any digit occurring in the dialed string at the character position where used.

 **NOTE:**

The user-dialed digits are matched to the Dialed String entry that most closely matches the dialed number (referred to as the longest match). For example, if a user dials 297-1234 and the AAR or ARS Analysis Table has dialed string entries of 297-1 and 297-123, the match is on the 297-123 entry. In addition, an exact match is made on dialed string entries of the same number of digits in cases where wildcard characters are used. For example, if 424 is dialed and the table has dialed string entries of 424 and X24, the match is on the 424 entry.

An example of dialed string entries and associated Min and Max entries is provided in the following table. RNxs 200 through 299 can be assigned on the AAR Analysis Table in the following ways:

| Dialed String | Min. # of Digits | Max. # of Digits |
|---------------|------------------|------------------|
| 2             | 7                | 7                |
|               | or               |                  |
| 20            | 7                | 7                |
| 21            | 7                | 7                |
| 22            | 7                | 7                |
| ...           | ...              | ...              |
| 29            | 7                | 7                |

- **Min** — Enter the minimum number of digits needed to validate and route the call. Default is blank.
- **Max** — Enter the maximum number of digits to collect, between **Min** and **28**. Default is blank.
- **Rte Pat** (Route Pattern) — Enter the route pattern number or a pointer to an associated Remote Home Number Plan Area (RHNPA) form (**r1** to **r32**) to be used to route the call once all identifying digits have been received, **nod** to use node number routing, **n/a** to indicate that routing is not applicable to this PGN, **den** to block the call, or blank (default).
- **Call Type** (for AAR only) — Enter **aar** for regular AAR calls. Enter **intl**, or **pubu** if the administered route pattern contains preferences which are public network ISDN trunks requiring Type of Number (TON) encodings "international" or unknown respectively. Enter **lev0**, **lev1**, or **lev2** or leave blank (default) to specify Private Numbering Plan (PNP) number formats. See the ISDN Protocol Table below for the Numbering Plan Identifier (NPI) and Type of Numbering based on Call Type.

| Call Type | Numbering Plan Identifier | Type of Numbering   |
|-----------|---------------------------|---------------------|
| aar       | E.164(1)                  | national(2)         |
| intl      | E.164(1)                  | international(1)    |
| pubu      | E.164(1)                  | unknown(0)          |
| lev0      | PNP(9)                    | local(4)            |
| lev1      | PNP(9)                    | Regional Level 1(2) |
| lev2      | PNP(9)                    | Regional Level 2(1) |

- **Call Type** (for ARS only) — Valid call types are:

| Call Type | Description  | China # 1 Call Type |
|-----------|--|---------------------|
| alrt      | alerts attendant console for emergency   | normal              |
| emer      | emergency call   | normal              |
| fnpa      | 10-digit North American Numbering Plan (NANP) call (11 digits with Prefix Digit "1") | attendant           |
| hnpa      | 7-digit NANP call  | normal              |
| intl      | public-network international number  | toll-auto           |



| Call Type | Description                           | China # 1<br>Call Type |
|-----------|---------------------------------------|------------------------|
| iop       | international operator                | attendant              |
| loc1      | public-network local number           | normal                 |
| lpvt      | local private                         | normal                 |
| nat1      | non-NANP                              | normal                 |
| npvt      | national private                      | normal                 |
| nsvc      | national service                      | normal                 |
| op        | operator                              | attendant              |
| pubu      | public-network number (E.164)-unknown | normal                 |
| svcl      | national(2)                           | toll-auto              |
| svct      | national(2)                           | normal                 |

- **Node Number** — The number of the destination node if node number routing or DCS are used.
- **ANI Rq** — Enter **y** if ANI is required on incoming R2-MFC or Russian MF ANI calls. Default is **n**. This field only applies if the `Request Incoming ANI (non-AAR/ARS)` field on the Multifrequency-Signaling-Related System Parameters form is **n**.

## AAR and ARS Digit Analysis Default Translations

[Table 8-1](#) lists the AAR and ARS Digit Analysis Default Translations.

[Table 8-2](#) lists the ARS Digit Analysis Default Translations.

Table 8-1. AAR Digit Analysis Default Translations

| Dialed String | Total Digits |      | Call Type |
|---------------|--------------|------|-----------|
|               | Min.         | Max. |           |
| 2             | 7            | 7    | aar       |
| 3             | 7            | 7    | aar       |
| 4             | 7            | 7    | aar       |
| 5             | 7            | 7    | aar       |
| 6             | 7            | 7    | aar       |
| 7             | 7            | 7    | aar       |
| 8             | 7            | 7    | aar       |
| 9             | 7            | 7    | aar       |

 **NOTE:**

Any dialed digit-string not accounted for on the table is considered invalid and the call is routed to intercept. These default translations are used for call processing regardless of whether or not AAR or ARS has been optioned for on the switch.

The translations shown in [Table 8-2](#) appear only once in the switch's memory but are displayed in sorted order (including additions) on each of the 8 possible ARS Digit Analysis Tables.

 **NOTE:**

For service outside of North America, these defaults should be deleted. You can delete the defaults by entering **change ARS analysis 0**. Then blank out all of the Dialed Strings with spaces.

Table 8-2. ARS Digit Analysis Default Translations

| Dialed String | Total Digits |      | Route Pattern | Call Type |
|---------------|--------------|------|---------------|-----------|
|               | Min.         | Max. |               |           |
| 0             | 1            | 1    | den           | op        |
| 0             | 8            | 8    | den           | op        |
| 0             | 11           | 11   | den           | op        |
| 00            | 2            | 2    | den           | op        |
| 01            | 9            | 17   | den           | iop       |
| 011           | 10           | 18   | den           | intl      |
| 10XXX0        | 6            | 6    | den           | op        |
| 10XXX0        | 16           | 16   | den           | op        |
| 10XXX01       | 14           | 22   | den           | iop       |
| 10XXX011      | 15           | 23   | den           | intl      |
| 1XXX555       | 11           | 11   | den           | fnpa      |
| 1XXX976       | 11           | 11   | den           | fnpa      |
| 1800555       | 11           | 11   | den           | fnpa      |
| 1809          | 11           | 11   | den           | fnpa      |
| 1900555       | 11           | 11   | den           | fnpa      |
| 411           | 3            | 3    | den           | svc       |
| 555           | 7            | 7    | den           | hnpa      |
| 611           | 3            | 3    | 1             | svc       |
| 811           | 3            | 3    | 1             | svc       |
| 911           | 3            | 3    | 1             | svc       |
| 976           | 7            | 7    | den           | hnpa      |
| N             | 7            | 7    | 2             | hnpa      |
| 1N00          | 11           | 11   | den           | fnpa      |

*Continued on next page*

Table 8-2. ARS Digit Analysis Default Translations  
— *Continued*

---

| Total Digits  |      |      |               |           |
|---------------|------|------|---------------|-----------|
| Dialed String | Min. | Max. | Route Pattern | Call Type |
| 1NX           | 11   | 11   | den           | fnpa      |

---

Legend:

- N - 2 through 9
  - X - any digit (0 - 9)
  - den - deny
  - fnpa - foreign number plan area (10-digit call)
  - hnpa - home number plan area (7-digit call)
  - intl - international
  - iop - international operator
  - op - operator
  - svc - service
-

## AAR and ARS Digit Conversion Table

This form converts private-network numbers to other private-network or to public-network ARS numbers. It is essential for converting home AAR numbers into extension numbers. Using this table, you can:

- Steer some AAR calls to other switches in the private network
- Change the dialed string to a public-network number and route the call via the ARS feature
- Block or intercept certain private-network calls to the attendant group
- Route unauthorized public-network calls to an attendant or give them intercept tone

The form allows for the replacement of all or part of a dialed string with a modified string and/or change of analysis type. The modified string represents an alternative equivalent address and results in call analysis according to the network type. This table is accessed during call-processing.

Digit conversion enhances the capabilities of the AAR and ARS features so that outgoing public-network calls and private-network calls can be changed to local, private, or public network destinations. The calls are then analyzed by the UDP, AAR, or ARS features and routed according to the associated route patterns.

### Administration commands

Use the following commands to administer the AAR and ARS Digit Conversion Table form.

| Action  | Object                                       | Qualifier <sup>1</sup>   |
|---------|--|--|
| change  | aar digit-conversion<br>ars digit-conversion | Enter digits between 0 to 9 'x' or 'X'                                       |
| display | aar digit-conversion<br>ars digit-conversion | Enter digits between 0 to 9 'x' or 'X'<br>['print' or 'schedule']            |
| list    | aar digit-conversion<br>ars digit-conversion | Enter ['start' matching pattern]['count'<br>(1-MAX)] ['print' or 'schedule'] |

1. Brackets [ ] indicate the qualifier is optional. Single quotes ( ' ) indicate the text inside the quote must be entered exactly as shown or an abbreviated form of the word may be entered. MAX is the maximum number available in your system configuration.

**Form Instructions**

---

| Page 1 of 2                |     |     |     |                    |     |      |     |     |
|----------------------------|-----|-----|-----|--------------------|-----|------|-----|-----|
| AAR DIGIT CONVERSION TABLE |     |     |     |                    |     |      |     |     |
| Percent Full: ____         |     |     |     |                    |     |      |     |     |
| Matching Pattern           | Min | Max | Del | Replacement String | Net | Conv | ANI | Req |
| _____                      | __  | __  | __  | _____              | __  | -    | -   | -   |
| _____                      | __  | __  | __  | _____              | __  | -    | -   | -   |
| _____                      | __  | __  | __  | _____              | __  | -    | -   | -   |
| _____                      | __  | __  | __  | _____              | __  | -    | -   | -   |
| _____                      | __  | __  | __  | _____              | __  | -    | -   | -   |
| _____                      | __  | __  | __  | _____              | __  | -    | -   | -   |
| _____                      | __  | __  | __  | _____              | __  | -    | -   | -   |
| _____                      | __  | __  | __  | _____              | __  | -    | -   | -   |
| _____                      | __  | __  | __  | _____              | __  | -    | -   | -   |
| _____                      | __  | __  | __  | _____              | __  | -    | -   | -   |
| _____                      | __  | __  | __  | _____              | __  | -    | -   | -   |
| _____                      | __  | __  | __  | _____              | __  | -    | -   | -   |
| _____                      | __  | __  | __  | _____              | __  | -    | -   | -   |
| _____                      | __  | __  | __  | _____              | __  | -    | -   | -   |
| _____                      | __  | __  | __  | _____              | __  | -    | -   | -   |
| _____                      | __  | __  | __  | _____              | __  | -    | -   | -   |
| _____                      | __  | __  | __  | _____              | __  | -    | -   | -   |
| _____                      | __  | __  | __  | _____              | __  | -    | -   | -   |

Screen 8-3. AAR Digit Conversion Table

| Page 1 of 2                |     |     |     |                    |     |      |     |     |
|----------------------------|-----|-----|-----|--------------------|-----|------|-----|-----|
| ARS DIGIT CONVERSION TABLE |     |     |     |                    |     |      |     |     |
| Percent Full: ____         |     |     |     |                    |     |      |     |     |
| Matching Pattern           | Min | Max | Del | Replacement String | Net | Conv | ANI | Req |
| _____                      | __  | __  | __  | _____              | __  | -    | -   | -   |
| _____                      | __  | __  | __  | _____              | __  | -    | -   | -   |
| _____                      | __  | __  | __  | _____              | __  | -    | -   | -   |
| _____                      | __  | __  | __  | _____              | __  | -    | -   | -   |
| _____                      | __  | __  | __  | _____              | __  | -    | -   | -   |
| _____                      | __  | __  | __  | _____              | __  | -    | -   | -   |
| _____                      | __  | __  | __  | _____              | __  | -    | -   | -   |
| _____                      | __  | __  | __  | _____              | __  | -    | -   | -   |
| _____                      | __  | __  | __  | _____              | __  | -    | -   | -   |
| _____                      | __  | __  | __  | _____              | __  | -    | -   | -   |
| _____                      | __  | __  | __  | _____              | __  | -    | -   | -   |
| _____                      | __  | __  | __  | _____              | __  | -    | -   | -   |
| _____                      | __  | __  | __  | _____              | __  | -    | -   | -   |
| _____                      | __  | __  | __  | _____              | __  | -    | -   | -   |
| _____                      | __  | __  | __  | _____              | __  | -    | -   | -   |
| _____                      | __  | __  | __  | _____              | __  | -    | -   | -   |
| _____                      | __  | __  | __  | _____              | __  | -    | -   | -   |
| _____                      | __  | __  | __  | _____              | __  | -    | -   | -   |

Screen 8-4. ARS Digit Conversion Table Form

 **NOTE:**

When the form is accessed via a **display** or **change** command, the entries are sorted separately in the order of the matching pattern. Specific digits are sorted before the characters “\*,” “X,” or “X.”

- **Percent Full** — 3-character display-only field. Displays the percentage of the used system’s memory resources. A common pool of memory resources is shared between the ARS and AAR Digit Conversion tables.

If this field indicates that the system memory resources are in jeopardy of becoming full (100%), perform any of the following to free-up memory resources:

- Delete unnecessary entries from any of the shared resources tables
- Use RHNPA Tables for 6-digit screening
- Reduce `Dialed String` entries to shortest possible length that accomplishes the desired function

- **Matching Pattern** — Enter a 1–18-digit string to be matched against a dialed number. Matching Pattern entries must be unique within the table. The string may contain the digits 0–9 or a \* and wildcard characters “x” or “X.” These are used to match any digit in the range of 0–9 or \*. If a Prefix Digit is required for 10-digit DDD numbers, then the Prefix Digit “1” must be present in the Matching Pattern string for the match to succeed.

If the associated `Replacement String` has an entry, `Matching Pattern` must also have an entry.

- **Min** — The minimum number of digits in the dialed string
- **Max** — Enter the maximum number of digits to collect, between `Min` and **28**.
- **Del** — The number of digits to delete from the beginning of the dialed string
- **Replacement String** — Enter a 0–18-digit dialed string that replaces the deleted portion of the dialed number. The dialed string may contain the digits 0–9 or \*, a “#” character, or be blank. The “#” character, when used, must be at the end of the digit-string and is used to indicate end-of-dialing.

 **NOTE:**

A blank `Replacement String` has the effect of just deleting the leading digits from the dialed string. Because the “#” character in the `Replacement String` indicates the end-of-dialing, any digits dialed after the inserted portion of the string are ignored. Deletion of digits and blank replacements are used to crossover from ARS to AAR.

8 Automatic Routing Forms  
AAR and ARS Digit Conversion Table

Page 8-66

- **Net** — The network in which to analyze the resulting number. Enter **ext**, **aar**, or **ars**. The resulting digit-string is then analyzed as an extension number, an AAR address, or an ARS address respectively.
- **Conv** — Enter **y** or **n**. To allow further conversion enter **y**.
- **ANI Req** — Enter **y** if ANI is required on incoming R2-MFC or Russian MF ANI calls. Default is **n**. This field only applies if the `Request Incoming ANI (non-AAR/ARS)` field on the Multifrequency-Signaling-Related System Parameters form is **n**.



## Route Pattern form

---

The digit translations performed by the AAR and ARS Digit Analysis and RHNPA Tables cause a specific route pattern to be selected for routing the call. The route pattern contains a sequence of trunk groups on which an attempt is made to route the call.

The Route Pattern form implements one route pattern. Each route pattern can contain alternate trunk groups. The maximum number of route patterns and alternate trunk groups allowed depends on the configuration and memory available in your system.

The route patterns specified on the Route Pattern form are used by the following features: AAR, ARS, GRS, and Call-by-Call Service Selection.

Before a call is routed, DEFINITY ECS checks the Facility Restriction Level (FRL) compatibility to ensure:

- Calling party's FRL is greater than or equal to the routing preference's FRL
- Calling party's BCC matches the BCC specified for the routing preference (ISDN calls only)
- Facility type is okay for the call type
- There is an unused circuit (trunk port) available in the selected trunk group

When all checks are complete and compatibility is ensured, digits are outpulsed over the selected trunk group member.

## Administration commands

---

Use the following commands to administer the Route Pattern form

| Action  | Object        | Qualifier <sup>1</sup>  |
|---------|---------------|---|
| change  | route-pattern | 1-MAX   |
| display | route-pattern | 1-MAX [print]   |
| list    | route-pattern | Enter ['trunk' (1-MAX)] ['service'/feature name string] ['print' or 'schedule'] |

---

1. Brackets [ ] indicate the qualifier is optional. Single quotes ( ' ') indicate the text inside the quote must be entered exactly as shown or an abbreviated form of the word may be entered. MAX is the maximum number available in your system configuration.

**Form Instructions**

```

change route-pattern 1                                     Page 1 of X
                                     Pattern Number: 1_

  Grp.  FRL NPA Pfx Hop Toll No. Del Inserted          IXC
  No.   Mrk Lmt List Digits Digits
1: _____ user
2: _____ user
3: _____ user
4: _____ user
5: _____ user
6: _____ user

  BCC VALUE  TSC CA-TSC  ITC  BCIE Service/Feature          Numbering
  0 1 2 3 4 W  Request
1: y y y y y n y none_____ both ept  outwats-bnd_____ BAND: _____
2: y y y y y n n          rest          _____
3: y y y y y n n          rest          _____
4: y y y y y n n          rest          _____
5: y y y y y n n          rest          _____
6: y y y y y n n          rest          _____
    
```

Screen 8-5. Route Pattern form (Page 1 of X)

Make assignments as required for the following fields on the form:

- **Pattern Number** — This is a display-only field when the form is accessed using an administration command such as **change** or **display**.
- **Grp No.** — Enter the desired trunk-group number to specify which trunk-group will be associated with the entries on this line of the form.
- **FRL** — Enter the FRL **0–7** to be assigned this routing preference (this line of parameters on the form). 0 is the least restrictive and 7 is the most restrictive. Trunk-group FRLs are changeable from pattern to pattern. The calling party's FRL must be greater than or equal to this FRL to access the associated trunk-group.

Valid entries are 0 to 7.

 **NOTE:**

For system security reasons, Lucent recommends using the most restrictive FRL possible.

- **NPA** — This entry is not required for AAR. For ARS, enter the NPA of the distant-end (terminating endpoint). For WATS trunks, the NPA is the same as the home NPA unless the LEC wants 10 digits for local NPA calls. For tie trunks, the NPA field is left blank. Valid entries are 3-digits in the form: first digit (**2–9**), second digit (**0–9**), third digit (**0–9**). Default is blank.
- **Prefix Mark** — Not required for AAR. For ARS, enter a number from **0–4** or blank (default) as indicated below. This specifies whether the prefix digit 1 is outpulsed.

For a WAT -trunk, the Prefix Mark is the same as the local CO trunk. Prefix Mark operations only apply to FNPA or HNPA call types (ARS). For tie trunks, leave field this blank.

- 0 Indicates that the Prefix digit 1 is never outpulsed for 10-digit user-dialed FNPA calls, but leaves a user-dialed Prefix digit 1 for 7-digit HNPA calls. Prefix Mark 0 also leaves 1s on 10-digit calls that are not administered as FNPA- or HNPA-types.

 NOTE:

FNPA and HNPA are North American Numbering Plan terms.

- 1 Indicates that the Prefix digit 1 is outpulsed if and only if the call is a 10-digit call. Select Prefix Mark 1 for those HNPAs that require users to dial 1 to indicate a toll-call.
- 2 Indicates that the Prefix digit 1 is outpulsed for all toll calls, 7- and 10-digit. Prefix Mark 2 must refer to a Toll Table. See *Toll List* definition.
- 3 Indicates that the Prefix digit 1 is outpulsed for all toll-calls. These calls are always outpulsed as 10-digit numbers, even if they are within the HNPA. Prefix Mark 3 must refer to a Toll Table. See *Toll List* definition.
- 4 Indicates that the user-dialed Prefix digit 1 is always suppressed.

 NOTE:

This capability is required, for example, when routing ISDN calls to an Lucent Technologies 4ESS. If the prefix digit 1 were not suppressed, then the 4ESS would reject such calls.

- **Hop Lmt** — Controls the number of hops for each preference. A blank in this field indicates that there is no limit to the number of hops for this preference. Enter a number from **1–9** to limit the number of hops if using the tandem hop feature. Enter a number from **1–32** if using the transit feature. DEFINITY ECS blocks a hop equal to or greater than the number you enter.
- **Toll List** — Not required for AAR. For ARS, enter a number that references the ARS Toll Table associated with the terminating NPA of the trunk group. This field must be completed if *Prefix Mark* is **2** or **3**. Default is blank.
- **No. Del. Digits** — Enter the total number of digits to be deleted from the dialed string when selecting this trunk-group for call-routing. Default is blank.

Any nonblank entry in this field (including 0) causes any user-dialed IXC code to be deleted in addition to the number of digits specified.



**NOTE:**

Use 0 (zero) in this field to suppress user-dialed IXC codes. This capability is useful when the call is routed via ISDN trunks to a 4ESS office. The 4ESS will reject a call if the IXC code is sent along with the address digits.

- **Inserted Digits** — Enter the actual digits to be inserted. Up to 52 digits may be outpulsed. This includes 36 digits which you enter here plus up to 18-digits originally dialed. When they are used, special symbols count as two digits each. The special characters used in route patterns are described below.

| Special Character | Description  |
|-------------------|--|
| *                 | digit * (See note below <sup>1</sup> .)  |
| #                 | digit # (See note below <sup>1</sup> .)  |
| ,                 | 1.5 second pause   |
| +                 | Wait for dial tone up to the Off Premises Tone Detection Timer and then either outpulse or intercept tone based on <i>Out Pulse Without Tone y/n</i> (Feature-Related System Parameters form). Outpulsed DTMF digits are sent at the rate specified by the End-to-End Signaling Tone and Pause parameters (Trunk Group Administrable Timers form). |
| %                 | Start End-to-End Signaling. Send digits as DTMF inband tones at the rate specified by the End-to-End Signaling tone and Pause parameters (Trunk Group Administrable Timers form).  |
| !                 | Wait for dial tone without timeout and then outpulse DTMF digits at the rate specified by the End-to-End Signaling Tone and Pause parameters (Trunk Group Administrable Timers form).  |
| &                 | Wait for ANI (used for Russian pulse trunks to indicate where to wait for ANI prompt and send in-band ANI)   |

1. If the outgoing trunk is signaling type "mf," the signal administered as the "end-of-digit" in the Outgoing Group column of the System-Parameters Multifrequency-Signaling form is inserted, and not the "\*" or the "#."



**NOTE:**

Do not use a comma "," (1.5 second pause) as the first character in the string unless absolutely necessary. Misuse of the character can result in calls, such as Abbreviated Dialing or Last Number Dialed, not completing to the far end.

When an asterisk "\*" is translated in the route pattern and the signal "end-of-dial" is translated on the Multifrequency-Signaling form, the MFC tone for the "end-of-digits" is sent out to the CO in place of the asterisk "\*."

- **IXC** — Displays when ISDN-PRI or ISDN-BRI Trunks are enabled on the System-Parameters Customer-Options form. For ISDN Preference trunks, enter the last two-to-four digits to represent an equal access inter-exchange carrier (IXC) code number (such as 10XX or 10XXX).

 **NOTE:**

This length should match the format established on the IXC Codes form.

This field is used by all calls that route via an IXC, and is used also for Call Detail Recording (CDR). If an IXC is not specified, a call is transmitted by the presubscribed common carrier.

 **NOTE:**

The IXC field must be **none** for non-ISDN trunk groups and for Bellcore NI-2 Operator Service Access. If you need to send an IXC code for a non-ISDN trunk group, then enter this IXC value in *Inserted Digits*.

- **BCC Value** (required by GRS feature) — Displays when ISDN-PRI or ISDN-BRI Trunks are enabled on the System-Parameters Customer-Options form. Enter **y** (default) or **n** in the appropriate BCC column (0, 1, 2, 3, 4, or W) to specify whether the BCC is valid for the associated route. The following defines the BCC values:

| BCC Value | Description                      |
|-----------|----------------------------------|
| 0         | Voice-Grade Data and Voice       |
| 1         | 56-kbps Data (Mode 1)            |
| 2         | 64-kbps Data (Mode 2)            |
| 3         | 64-kbps Data (Mode 3)            |
| 4         | 64-kbps Data (Mode 0)            |
| W         | 128 to 1984-kbps Data (Wideband) |

- **TSC** — Enter **y** to allow incoming Non-Call-Associated TSC requests to be tandemed out and to allow the establishment of Call-Associated TSCs associated with B-channel connections of that preference. To achieve feature transparency, DCS+ calls should be routed via a route pattern that has an ISDN-PRI Used for DCS trunk-group as a first preference.

- **CA-TSC Request** — Appears when **TSC** is **y**. A CA-TSC uses the call reference value of the call control data packets to exchange user-information messages associated with an ISDN B-channel connection. CA-TSCs are a finite system and trunk group resource. There is a trade-off between the two possible entries — a small time-lag with the first and usage generated by the second. Valid entries are:

|           |  |
|-----------|--|
| as-needed | (Recommended for most situations.) CA-TSC is not established along with the B-channel call. If a CA-TSC is needed due to feature activation somewhere in the lifetime of this B-channel call, then the CA-TSC is established at that time and remains active for the duration of the call. |
| at-setup  | Causes a CA-TSC to be established at the same time as the initial B-channel connection is established. In other words, a CA-TSC is set up for each and every B-channel call <b>whether CA-TSC is ever needed</b> .   |
| none      | Disallows the establishment of CA-TSCs associated with B-channel connections of the current preference (tandeming of NCA-TSC setup requests, however, are still permitted).  |

 **NOTE:**

With **as-needed**, the need to establish the CA-TSC causes a slight delay in the invocation of the Call-Associated feature. This delay is not present with **at-setup** because the CA-TSC is established already at call-setup and is ready to be used immediately upon feature invocation.

- **ITC** (Information Transfer Capability) — Used to administer the type of traffic (restricted, unrestricted, or both) that is allowed to be carried by this routing preference. If entering **rest** (restricted), then only calls originating from restricted endpoints may access this route pattern. If entering **unre** (unrestricted), then only calls originating from unrestricted endpoints may access this route pattern. If entering **both**, then calls originating from both restricted and unrestricted endpoints may access the route pattern.

This field must be **unre** or **both** if **BCC W** is **y**.

- **BCIE** (Bearer Capability Information Element) — Used to determine how to create the ITC codepoint in the BCIE of the setup message. This field only applies to ISDN trunks and is displayed and administrable only if **ITC** is **both**. Valid entries are **ept** (endpoint) and **unr** (unrestricted). Default is **ept**.

- **Service/Feature** (required by the Call-by-Call Service Selection feature) — Displays when ISDN-PRI or ISDN-BRI Trunks is enabled on the System-Parameters Customer-Options form. Enter up to 15 characters that represent the Service/Feature carried by a call in this route pattern. Default is blank. Valid entries are:
  - accunet
  - i800
  - inwats
  - lds
  - mega800
  - megacom
  - multiquest
  - operator
  - outwats-bnd
  - sdn
  - sub-operator
  - wats-max-bnd
- **Band** (required by the Call-by-Call Service Selection feature) — Displays when ISDN-PRI or ISDN-BRI Trunks is enabled on the System-Parameters Customer-Options form. Enter a number that represents the OUTWATS band number. This field displays when Services/Features is **outwats-bnd**. The default is blank.
- **Numbering Format** — Displays when ISDN-PRI or ISDN-BRI Trunks is enabled on the System-Parameters Customer-Options form. This field specifies the format of the routing-number used for the trunk group administered for the preference. You can leave the field blank (default) or you can enter one of the following values from [Table 8-3](#) if the trunk group specified for preference is ISDN:

**Table 8-3. Numbering Format Values**

| Route Pattern Format | Numbering Plan Identifier | Type of Numbering   |
|----------------------|---------------------------|---------------------|
| blank                | E.164(1)                  | 1-MAX               |
| natl-pub             | E.164(1)                  | national(2)         |
| intl-pub             | E.164(1)                  | international(1)    |
| locl-pub             | E.164(1)                  | local/subscriber(4) |

*Continued on next page*

Table 8-3. Numbering Format Values — *Continued*

| Route Pattern Format | Numbering Plan Identifier       | Type of Numbering   |
|----------------------|---------------------------------|---------------------|
| pub-unk              | E.164(1)                        | unknown(0)          |
| lev0-pvt             | Private Numbering Plan - PNP(9) | local(4)            |
| lev1-pvt             | Private Numbering Plan - PNP(9) | Regional Level 1(2) |
| lev2-pvt             | Private Numbering Plan - PNP(9) | Regional Level 2(1) |
| unk-unk              | unknown(0)                      | unknown(0)          |



**NOTE:**

To access Bellcore NI-2 Operator Service Access, Inserted Digits must be **unk-unk**.

- **LAR** — Enter the routing-preference for Look Ahead Routing. The choices are described below.

| LAR Value | DEFINITY ECS Actions   |
|-----------|--|
| next      | Go to the next routing-preference and attempt the call again                             |
| rehu      | Rehunt within the current routing-preference for another trunk to attempt the call again |
| none      | Look Ahead Routing is not enabled for the preference                                     |

**Implementation Notes**

The number of pages displayed depends upon the amount of system memory. Also, many of the fields only display under certain conditions. See field definitions for those conditions.



## ARS Toll Table

This form assigns ARS Toll Tables used by Subnet Trunking. Use it to specify whether calls to CO codes listed on the table are toll or non-toll calls. You specify non-toll calls based on the last 2 digits of the distant-end of the trunk group.

### Administration commands

Use the following commands to administer the ARS Toll Table form.

| Action  | Object   | Qualifier <sup>1</sup>                                    |
|---------|----------|---|
| change  | ars toll | n:xxx (1-MAX:office code) n:xyy: n(1-MAX); ':' ;x(2-MAX); |
| display | ars toll | n:xxx (1-MAX:office code) ['print' or 'schedule']         |

1. Brackets [ ] indicate the qualifier is optional. Single quotes ( ' ') indicate the text inside the quote must be entered exactly as shown or an abbreviated form of the word may be entered. MAX is the maximum number available in your system configuration.

### Form Instructions

ARS TOLL TABLE: \_\_\_ Page 1 of 1

OFFICE CODES: x00-x99

|       |       |       |       |       |       |       |       |       |       |
|-------|-------|-------|-------|-------|-------|-------|-------|-------|-------|
| 00: y | 10: y | 20: y | 30: y | 40: y | 50: y | 60: y | 70: y | 80: y | 90: y |
| 01: y | 11: y | 21: y | 31: y | 41: y | 51: y | 61: y | 71: y | 81: y | 91: y |
| 02: y | 12: y | 22: y | 32: y | 42: y | 52: y | 62: y | 72: y | 82: y | 92: y |
| 03: y | 13: y | 23: y | 33: y | 43: y | 53: y | 63: y | 73: y | 83: y | 93: y |
| 04: y | 14: y | 24: y | 34: y | 44: y | 54: y | 64: y | 74: y | 84: y | 94: y |
| 05: y | 15: y | 25: y | 35: y | 45: y | 55: y | 65: y | 75: y | 85: y | 95: y |
| 06: y | 16: y | 26: y | 36: y | 46: y | 56: y | 66: y | 76: y | 86: y | 96: y |
| 07: y | 17: y | 27: y | 37: y | 47: y | 57: y | 67: y | 77: y | 87: y | 97: y |
| 08: y | 18: y | 28: y | 38: y | 48: y | 58: y | 68: y | 78: y | 88: y | 98: y |
| 09: y | 19: y | 29: y | 39: y | 49: y | 59: y | 69: y | 79: y | 89: y | 99: y |

### Screen 8-6. ARS Toll Table

- **ARS TOLL TABLE** — Enter the ARS Toll Table number. Up to 8 forms may be required for each table, one for each 100-block, 2 to 9.
- **OFFICE CODES** — Enter a 100-block — 200–299 through 900–999. A separate form is required for each 100-block.
- **00:** through **99:** — Enter **n** beside each CO code to be designated as non-toll. These fields represent the last 2 digits of the codes within the 100-block. If no changes are made, the codes are implemented as toll-type codes (default).

## RHNPA Table

---

The Remote Home Numbering Plan Area (RHNPA) Table assigns additional 3-digit screenings (for instance, on the prefix or nxx numbers) and associated route pattern numbers for up to 32 RHNPA Tables (r1–r32). One form is required for each 100-block of codes in the range 000–999. RHNPA Tables can be used with any call-type and a choice of up to 12 route patterns is provided for each 100-block of codes.

RHNPA Tables typically are used for the DDD prefixes.

The ARS Digit Analysis Table performs translations on the first 3 digits of the dialed string. The RHNPA Table performs translations on the next 3-digit dialed string.

### Example

The `Rte Pat` fields on the ARS Digit Analysis Table are set to r1, r10 and r32. These point to the respective RHNPA Tables 1, 10, or 32. Therefore, the next 3 digits dialed represent a CO code in the FNPA. These digits are translated by the RHNPA Table and routed via the assigned route pattern to the CO.

The RHNPA Table can also be used for AAR analysis.

## Administration commands

---

Use the following commands to administer the RHNPA Table form.

| Action  | Object | Qualifier <sup>1</sup>  |
|---------|--------|---|
| change  | rhnpa  | Enter RHNPA and office code n:xyy n(1-MAX) x(0-MAX) y(0-MAX) y(0-MAX)                       |
| display | rhnpa  | Enter RHNPA and office code n:xyy n(1-MAX) x(0-MAX) y(0-MAX) y(0-9) ['print' or 'schedule'] |

- 
1. Brackets [ ] indicate the qualifier is optional. Single quotes ( ' ' ) indicate the text inside the quote must be entered exactly as shown or an abbreviated form of the word may be entered. MAX is the maximum number available in your system configuration.

**Form Instructions**

|   |             |
|---|-------------|
| RHNPA TABLE: ___  | Page 1 of 1 |
| CODE: x00 - x99   |             |
| Pattern Choices   |             |
| 1: ___ 3: ___ 5: ___ 7: ___ 9: ___ 11: ___                                      |             |
| 2: ___ 4: ___ 6: ___ 8: ___ 10: ___ 12: ___                                     |             |
| Code-Pattern Choice Assignments (from 1(en12 above)                             |             |
| 00: 1__ 10: 1__ 20: 1__ 30: 1__ 40: 1__ 50: 1__ 60: 1__ 70: 1__ 80: 1__ 90: 1__ |             |
| 01: 1__ 11: 1__ 21: 1__ 31: 1__ 41: 1__ 51: 1__ 61: 1__ 71: 1__ 81: 1__ 91: 1__ |             |
| 02: 1__ 12: 1__ 22: 1__ 32: 1__ 42: 1__ 52: 1__ 62: 1__ 72: 1__ 82: 1__ 92: 1__ |             |
| 03: 1__ 13: 1__ 23: 1__ 33: 1__ 43: 1__ 53: 1__ 63: 1__ 73: 1__ 83: 1__ 93: 1__ |             |
| 04: 1__ 14: 1__ 24: 1__ 34: 1__ 44: 1__ 54: 1__ 64: 1__ 74: 1__ 84: 1__ 94: 1__ |             |
| 05: 1__ 15: 1__ 25: 1__ 35: 1__ 45: 1__ 55: 1__ 65: 1__ 75: 1__ 85: 1__ 95: 1__ |             |
| 06: 1__ 16: 1__ 26: 1__ 36: 1__ 46: 1__ 56: 1__ 66: 1__ 76: 1__ 86: 1__ 96: 1__ |             |
| 07: 1__ 17: 1__ 27: 1__ 37: 1__ 47: 1__ 57: 1__ 67: 1__ 77: 1__ 87: 1__ 97: 1__ |             |
| 08: 1__ 18: 1__ 28: 1__ 38: 1__ 48: 1__ 58: 1__ 68: 1__ 78: 1__ 88: 1__ 98: 1__ |             |
| 09: 1__ 19: 1__ 29: 1__ 39: 1__ 49: 1__ 59: 1__ 69: 1__ 79: 1__ 89: 1__ 99: 1__ |             |

Screen 8-7. RHNPA Table (Page 1 of 1)

- **RHNPA TABLE** — Enter the applicable table number from 1–32. Up to 8 forms may be required for each table, one for each 100-block, 2 to 9.
- **CODE** — Enter the desired 100-block; that is, 000 through 099, 100 through 199, 200 through 299,...800 through 899, 900 through 999. A separate form is required for each 100-block.
- **Pattern Choices** — Enter a pattern number representing the route patterns that can be accessed by the RHNPA's identified on this form. Each form on each RHNPA Table may have 12 different route patterns (Pattern Choices). A Pattern choice listed on one form automatically defaults to the other forms of the same RHNPA Table. If one pattern is used most often (that is, accessed by the greatest number of CO codes in this block), assign that as Pattern Choice 1. Otherwise, the correlation between Pattern Choice Numbers and route patterns is completely arbitrary.
- **Code-Pattern Choice Assignments (from 1-12 above)** — Enter a Pattern Choice number from the list above in the field associated with each CO Code. The Code fields represent the last 2-digits of the codes within the 100-block. This field points to the Pattern Choice above, which contains the route pattern to be used.

## Time of Day Routing Plan

---

Use this form to assign Time of Day Routing Plans. Using this form, you can route AAR and ARS calls based on the time of day each call is made. Up to 8 Time of Day Routing Plans can be administered, each scheduled to change up to 6 times a day, for each day in the week.

The calling party's FRL must be greater than or equal to the FRL assigned in the route pattern. The route pattern is selected by matching on the Time of Day Routing Plan the PGN# with the Partitioned Group Number field on the AAR or ARS Digit Analysis Table. Then, the AAR or ARS Digit Analysis Table selects the route pattern.

### NOTE:

The following optional features must be enabled on the System-Parameters Customer-Options form before this form can be administered: Automatic Route Selection (ARS) or Private Networking, AAR/ARS Partitioning, and Time of Day Routing.

## Administration commands

---

Use the following commands to administer the Time of Day Routing Plan form.

| Action  | Object      | Qualifier <sup>1</sup>                      |
|---------|-------------|---|
| display | time-of-day | ['print' or 'schedule']                     |
| display | time-of-day | 1-MAX (plan number) ['print' or 'schedule'] |
| change  | time-of-day | [time of day routing plan (1-MAX)]          |

- 
1. Brackets [ ] indicate the qualifier is optional. Single quotes ( ' ' ) indicate the text inside the quote must be entered exactly as shown or an abbreviated form of the word may be entered. MAX is the maximum number available in your system configuration.

**Form Instructions**

| TIME OF DAY ROUTING PLAN x |       |      |         |      |         |      |         |      |         |      |         | Page 1 of 1 |         |
|----------------------------|-------|------|---------|------|---------|------|---------|------|---------|------|---------|-------------|---------|
| Act                        | PGN   | Act  | PGN     | Act  | PGN     | Act  | PGN     | Act  | PGN     | Act  | PGN     | Act         | PGN     |
| Time                       | #     | Time | #       | Time | #       | Time | #       | Time | #       | Time | #       | Time        | #       |
| Sun                        | 00:00 | 1    | ___:___ | -    | ___:___ | -    | ___:___ | -    | ___:___ | -    | ___:___ | -           | ___:___ |
| Mon                        | 00:00 | 1    | ___:___ | -    | ___:___ | -    | ___:___ | -    | ___:___ | -    | ___:___ | -           | ___:___ |
| Tue                        | 00:00 | 1    | ___:___ | -    | ___:___ | -    | ___:___ | -    | ___:___ | -    | ___:___ | -           | ___:___ |
| Wed                        | 00:00 | 1    | ___:___ | -    | ___:___ | -    | ___:___ | -    | ___:___ | -    | ___:___ | -           | ___:___ |
| Thu                        | 00:00 | 1    | ___:___ | -    | ___:___ | -    | ___:___ | -    | ___:___ | -    | ___:___ | -           | ___:___ |
| Fri                        | 00:00 | 1    | ___:___ | -    | ___:___ | -    | ___:___ | -    | ___:___ | -    | ___:___ | -           | ___:___ |
| Sat                        | 00:00 | 1    | ___:___ | -    | ___:___ | -    | ___:___ | -    | ___:___ | -    | ___:___ | -           | ___:___ |

Screen 8-8. Time Of Day Routing Form (Page 1 of 1)

- **Time of Day Routing Plan** — Specifies the TOD routing plan number. Up to 8 of these plans can be administered. This is a display-only field when the form is accessed using an administration command such as **add** or **change**.
- **Act Time** — Specifies the time of day the route pattern (identified by PGN #) is effective. The time is represented in military time (24:00 hours per day). List times for the same day in increasing order. Valid entries are **00:00–23:59**; default is **00:00**. There must be at least one entry for each day.
- **PGN #** — Enter a PGN that points to the appropriate AAR or ARS Digit Analysis Tables. The AAR or ARS Digit Analysis Tables should have the same PGN #. This is how you point to the route pattern that should be active for the activation time. There must be at least one entry for each day.

The AAR or ARS Digit Analysis Table selected and the route pattern used is based on the dialed string. Default is 1.

**NOTE:**

It is possible to point to an AAR or ARS Digit Analysis Table associated with a PGN that has a different FRL than the FRL assigned to the caller's facility. Proceed with caution when making these assignments.

Before a call is routed, DEFINITY ECS checks to see that the Calling party's FRL is greater than or equal to the routing preference's FRL.



## Call Center

# 9

---

This section contains the following DEFINITY ECS Call Center features. Call Center forms are located at the end of this chapter.

**Table 9-1. Call Center features**

| <b>Feature</b>                               | <b>Page</b>          |
|--|----------------------|
| <a href="#">Abandoned Call Search</a>        | <a href="#">9-3</a>  |
| <a href="#">Add/Remove Skills</a>            | <a href="#">9-5</a>  |
| <a href="#">Agent Call Handling</a>          | <a href="#">9-7</a>  |
| <a href="#">Auto-Available Split</a>         | <a href="#">9-22</a> |
| <a href="#">Automatic Call Distribution</a>  | <a href="#">9-25</a> |
| <a href="#">Basic Call Management System</a> | <a href="#">9-40</a> |
| <a href="#">Best Service Routing™</a>        | <a href="#">9-44</a> |
| <a href="#">Call Management System</a>       | <a href="#">9-58</a> |
| <a href="#">Call Prompting</a>               | <a href="#">9-60</a> |
| <a href="#">Call Vectoring</a>               | <a href="#">9-63</a> |
| <a href="#">Expert Agent Selection</a>       | <a href="#">9-72</a> |
| <a href="#">Inbound Call Management</a>      | <a href="#">9-81</a> |
| <a href="#">Information Forwarding</a>       | <a href="#">9-89</a> |
| <a href="#">Look-Ahead Interflow</a>         | <a href="#">9-98</a> |

---

*Continued on next page*

**Table 9-1. Call Center features — Continued**

| <b>Feature</b>                             | <b>Page</b>           |
|--|-----------------------|
| <a href="#">Multiple Call Handling</a>     | <a href="#">9-104</a> |
| <a href="#">Queue Status Indications</a>   | <a href="#">9-110</a> |
| <a href="#">Reason Codes</a>               | <a href="#">9-112</a> |
| <a href="#">Redirection on No Answer</a>   | <a href="#">9-116</a> |
| <a href="#">Universal Call ID</a>          | <a href="#">9-130</a> |
| <a href="#">VDN of Origin Announcement</a> | <a href="#">9-146</a> |
| <a href="#">Voice Response Integration</a> | <a href="#">9-152</a> |
| <a href="#">VuStats</a>                    | <a href="#">9-161</a> |

| <b>Forms</b>                      | <b>Page</b>           |
|-----------------------------------|-----------------------|
| <a href="#">Call Center Forms</a> | <a href="#">9-192</a> |

| <b>Related feature or form</b>  | <b>Page</b>           |
|---|-----------------------|
| <a href="#">“Announcements/Audio Sources”</a>   | <a href="#">5-26</a>  |
| <a href="#">Calling Party/Billing Number</a>  | <a href="#">4-246</a> |
| <a href="#">“CallVisor Adjunct-Switch Application Interface”</a>  | <a href="#">4-250</a> |
| <a href="#">“Class of Restriction”</a>  | <a href="#">4-264</a> |
| <a href="#">“Hunt Groups”</a>   | <a href="#">4-365</a> |
| <a href="#">“Malicious Call Trace”</a>  | <a href="#">4-422</a> |
| <a href="#">Recorded Announcement</a>   | <a href="#">4-500</a> |
| <a href="#">“Service Observing”</a>   | <a href="#">4-539</a> |
| <a href="#">CALLMASTER II and III voice terminals</a>   | <a href="#">6-141</a> |
| <a href="#">500, 2500, K2500, 7101A, 7102A, 7103A, 7104A, 8110, DS1FD, DS1SA, and VRU voice terminals</a> | <a href="#">6-47</a>  |



## Abandoned Call Search

---

Abandoned Call Search allows the switch to identify abandoned calls if the central office (CO) does not provide timely disconnect supervision. An abandoned call is one in which the calling party hangs up before the call is answered. Note that Abandoned Call Search is suitable only for older COs that do not provide timely disconnect supervision. Most COs provide timely disconnect supervision and do not require Abandoned Call Search.

Before an incoming Automatic Call Distribution (ACD) split rings a hunt group member or agent, the system checks to make sure that the calling party has not abandoned the call. If the calling party has abandoned the call, the call does not ring the hunt group member or agent.

If a call has been abandoned, the system determines if the calling party is still connected to the ground-start trunk at the CO. To do this, the system flashes (that is, opens the tip-ring loop for 150 to 200 ms) the CO end of the trunk. If the calling party is still connected, the CO does not respond. If the calling party has abandoned the call, the CO sends the system a disconnect signal within 800 ms. The system interprets this as an abandoned call, releases the trunk, and the call does not ring the hunt group member or agent.

Outside of the U.S., a flash of this duration may be handled differently. See [“Trunk Flash” on page 4-603](#) for more information.

### How to administer Abandoned Call Search

---

#### Required forms

---

| Form        | Field                   | Page                  |
|-------------|-------------------------|-----------------------|
| Trunk Group | ■ Abandoned Call Search | <a href="#">7-115</a> |
| — CO        |                         | <a href="#">7-168</a> |
| FX          |                         | <a href="#">7-193</a> |
| WATS        |                         | <a href="#">7-268</a> |

You administer Abandoned Call Search on a per-trunk-group basis. Administer each ground-start CO, FX, and WATS trunk group either having Abandoned Call Search or not having it. Abandoned Call Search is not supported for tie trunks.

## Considerations

---

### NOTE:

Abandoned Call Search works with ground-start analog trunks that *do not* provide disconnect supervision and that *do* react to a 500-ms break.

Some older COs can take as long as two minutes to notify the switch of a disconnect. Thus, the switch must determine within one second whether the call has been abandoned, before extending the call. Even with Abandoned Call Search or disconnect supervision, there is a small probability that a call will be extended to the destination hunt group after the caller has hung up. Abandoned Call Search and disconnect supervision significantly reduce that probability.

Abandoned Call Search allows agents and hunt group members to answer more calls because time is not wasted on abandoned calls. In addition, call-handling statistics that the Call Management System (CMS) generates are more accurate because it is clear when a call is abandoned.

However, be aware that Abandoned Call Search adds an overhead of up to one second to each call delivered to an agent.

## Interactions

---

None.

## Add/Remove Skills

---

Add/Remove Skills allows an agent using Expert Agent Selection (EAS) to add or remove skills. A skill is a numeric identifier in the switch that refers to an agent's specific ability. For example, an agent who is able to speak English and Spanish could be assigned a Spanish-speaking skill with an identifier of 20. The agent then adds skill 20 to his or her set of working skills. If a customer needs a Spanish-speaking agent, the system routes the call to an agent with that skill.

Each agent can have up to 20 skills active at any one time. Agents can dial feature access codes (FACs) to add or remove a skill. Or a supervisor with console permission can enter an agent's login ID and add or remove an agent's skill. If a supervisor adds or removes a skill for an agent, the agent receives a change notification.

To determine if they need to add or remove a skill, agents and supervisors can use queue-status indications, VuStats, or Call Management System (CMS) or Basic Call Management System (BCMS) information. When adding a skill, the agent must specify the skill priority level (1 — 16).

On voice terminals with displays, the system prompts the agent through the process of adding or removing a skill and displays the updated set of skills.

### How to administer Add/Remove Skills

---

#### Required forms

| Form                       | Field  | Page                  |
|----------------------------|--|-----------------------|
| Class of Restriction (COR) | ■ Add/Remove Agent Skills                        | <a href="#">5-72</a>  |
| Feature Access Code (FAC)  | ■ Add Agent Skills                               | <a href="#">5-113</a> |
|                            | ■ Remove Agent Skills                            |                       |
| Language Translations      | ■ 41-44 on Page 5                                | <a href="#">5-193</a> |
| Hunt Group                 | ■ Skill  | <a href="#">5-158</a> |
| Class of Service           | ■ Administer console permissions for supervisors | <a href="#">5-81</a>  |

### Considerations

---

- A skill cannot be removed from an agent's skill set if the agent is on a call for that skill or in the After-Call-Work (ACW) state for that skill.
- With EAS, agents cannot remove their Direct Agent Skill.

## Interactions

---

- Auto-Available Splits (AAS)

If an agent adds a skill that is administered as Auto-Available, on the Agent Login ID form, you must set the AAS field to **y** for that agent's login ID.

- BCMS

BCMS begins tracking a new skill as soon as it is added. When an agent removes a skill, the real-time agent information specific to that skill is removed from the real-time reports, but it still appears on the historical reports.

- EAS-PHD

When EAS-PHD is set as an option, agents cannot remove their Direct Agent Skill. In an EAS environment, agents must have at least one skill assigned to them during a login session. With EAS-PHD, agents can specify up to 20 skills.

If EAS-PHD is not enabled, agents can specify only 4 skills.

- VuStats

Because VuStats displays information gathered by BCMS whether BCMS is enabled or not, the BCMS interaction above applies to VuStats.

## Agent Call Handling

---

Agent Call Handling allows you to administer functions that Automatic Call Distribution (ACD) agents use to answer and process ACD calls.

You define the following agent capabilities:

- Agent login and logout
- Agent answering options: Automatic Answer (zip tone) or Manual Answer
- ACD work modes: Auxiliary Work (AUX Work), Auto-In, Manual-In, or After Call Work (ACW)
- Timed ACW
- Agent request for supervisor assistance
- ACD call disconnect (Release button)
- Stroke counts
- Call work codes
- Forced entry of stroke counts and call work codes

[“Agent capacity and related limits” on page 9-15](#) describes agent-capacity planning.

### NOTE:

All of these agent capabilities are also supported through the CallVisor Adjunct/Switch Applications Interface (ASAI). For information, see [“CallVisor Adjunct-Switch Application Interface” on page 4-250](#).

## How to administer Agent Call Handling

---

### Required forms

---

| Form                      | Field   | Page                  |
|---------------------------|---|-----------------------|
| Feature Access Code (FAC) | ■ Feature Access Codes for ACD features                         | <a href="#">5-113</a> |
| Hunt Group                | ■ Forced Stroke Count or Call Work Code<br>■ Timed ACW Interval | <a href="#">5-158</a> |
| Vector Directory Number   | ■ VDN Timed ACW Interval  | <a href="#">9-214</a> |

---

*Continued on next page*

**Required forms — Continued**

| <b>Form</b>                   | <b>Field</b>                           | <b>Page</b>           |
|-------------------------------|--|-----------------------|
| Station<br>(multi-appearance) | ■ Button/Feature Button Assignments    | <a href="#">6-28</a>  |
|                               | — manual-in                            |                       |
|                               | — auto-in                              |                       |
|                               | — aux-work                             |                       |
|                               | — after-call                           |                       |
|                               | — assist                               |                       |
|                               | — release                              |                       |
|                               | — work-code                            |                       |
|                               | — stroke-cnt                           |                       |
|                               | ■ Active Station Ringing (DCP, Hybrid) |                       |
|                               | ■ Idle/Active Ringing (CALLMASTER)     |                       |
| ■ VuStats                     |  |                       |
| Stations (all)                | ■ Auto Answer                          | <a href="#">6-28</a>  |
| Attendant Console             | ■ Feature Button Assignments           | <a href="#">5-35</a>  |
|                               | — after-call                           |                       |
|                               | — assist                               |                       |
|                               | — auto-in                              |                       |
|                               | — aux-work                             |                       |
|                               | — manual-in                            |                       |
|                               | — release                              |                       |
|                               | — work-code                            |                       |
|                               | — stroke-cnt                           |                       |
|                               | ■ Auto Answer                          |                       |
| Agent LoginID<br>(EAS only)   | ■ All                                  | <a href="#">9-193</a> |

## Detailed description

---

This section describes agents capabilities. For details on procedures that agents follow when using these capabilities, see *DEFINITY Enterprise Communications Server Generic 1, Generic 3, and System 75 Automatic Call Distribution (ACD) Agent Instructions*.

### NOTE:

This information applies generally to ACD; see [“Expert Agent Selection” on page 9-72](#) for additional EAS procedures.

## Agent login and logout

To receive ACD calls, an agent must log into the system. An agent can be logged into multiple splits. If a hunt group is measured by Call Management System (CMS) or Basic Call Management System (BCMS) or is a skill, an agent must enter a login ID; otherwise, the login ID is optional.

### Login

To log in, an agent goes off-hook and dials the login feature access code (FAC), followed by the split number and the log-in ID, if required. If login is successful, the agent automatically enters Auxiliary Work mode for that split. The Auxiliary Work button lamp for that split, lights steadily and the agent hears the confirmation tone.

If the split is measured, the system sends messages to CMS or BCMS that the agent (identified by login ID) has logged in and has entered Auxiliary Work mode.

Login is canceled and the agent receives intercept tone if any of the following occur during login:

- The agent dials an invalid login FAC or split number (that is, the number of a split that does not exist or to which the agent is not assigned).
- The agent is already logged into the maximum number of splits.
- The agent dials a split number for a split that he or she is already logged into.

### Logout

The agent should log out when he or she leaves for an extended period of time and is unavailable for ACD calls. If the split is measured by CMS or BCMS and an agent logs out, a message is sent to the CMS or BCMS so that the agent's status is no longer measured. If an agent is logged into multiple splits, he or she should log out of each split.

When temporarily unavailable for calls, an agent should use Auxiliary work mode, rather than logging out. CMS or BCMS can continue tracking the agent's auxiliary work time.

To log out of a split, an agent goes off-hook and dials the logout FAC followed by the split number. If logout is successful, the agent hears confirmation tone and work-mode button lamps darken. The logout is canceled and the agent receives an intercept if any of the following occur during logout:

- The agent dials an invalid logout FAC or split number.
- The agent dials a split number for a split that he or she is not logged into.

If an agent is using a handset in Automatic Answer mode, the agent can log out simply by hanging up or turning off the headset. (This does not mean pressing the release button on a CALLMASTER voice terminal.) This does not apply to quick-disconnect. If the agent pulls the handset to log out, the agent is automatically logged out of all splits that he or she has logged into.

## Agent answering options

An agent can answer ACD calls by using either a headset, handset, or speakerphone. You can assign an agent as either Automatic Answer or Manual Answer.

### NOTE:

Use Automatic Answer with a headset. See [“Considerations” on page 9-17](#) for more information.

## Automatic Answer

The information in this section applies to ACD and EAS environments.

An agent assigned to Automatic Answer hears zip tone and connects directly to incoming calls without ringing.

### NOTE:

You can administer Automatic Answer to apply only to ACD calls or to apply to all calls terminating to the agent's set. If all calls are Automatic Answer and the agent receives direct-extension calls, he or she should always activate Call Forwarding, or Send All Calls when leaving temporarily or for an extended period, so that calls do not terminate to an unstaffed station.

## Manual Answer

An agent assigned to Manual Answer hears ringing, and then goes off-hook to answer the incoming call.

## ACD work modes

At any given time, an agent can be in one of four work modes:

- Auxiliary Work (AUX)
- Auto-In
- Manual-In



- After Call Work (ACW)

An agent can change work modes at any time.

To enter any work mode, an agent presses the button or dials the FAC for that mode, depending on what you have administered. If the agent has no active or held calls, the work-mode button lamp lights steadily and CMS or BCMS is informed of the agent's mode change. If the agent has active or held calls, the lamp flashes until all calls are dropped, then the new work mode's lamp lights steadily and CMS or BCMS is informed of the agent's mode change.

The attempt is canceled and the agent receives an intercept if the agent:

- Tries to enter a work mode for an invalid split
- Tries to enter the work mode for a split of which he or she is not a member
- Dials an invalid FAC

### Auxiliary work mode

An agent should enter Auxiliary Work mode for a split whenever taking a temporary break. This makes the agent unavailable for ACD calls to that split and removes them from the most-idle-agent queue. CMS and BCMS can continue to track the agent.

The agent is no longer available to answer other ACD calls to that split. However, the agent may be available for ACD calls to other splits that the agent is logged into, depending on the agent's state in those splits. The agent is still available for non-ACD calls. CMS or BCMS are notified whenever an agent in Auxiliary Work mode receives an incoming non-ACD call or makes an outgoing call. When an agent logs into a split, he or she automatically enters Auxiliary Work mode for that split.

#### NOTE:

Agents in vector-controlled splits can go into Auxiliary Work mode even if they are the last agent and calls are queued to that split.

### Auto-In mode

In Auto-In mode, the agent automatically becomes available for answering new ACD calls upon disconnecting from an ACD call.

### Manual-In mode

In Manual-In mode, the agent automatically enters ACW mode for that split upon disconnecting from an ACD call and is not available for any ACD calls. To become available for ACD calls, the agent must manually reenter either Auto-In mode or Manual-In mode.

## After Call Work mode

An agent should enter ACW mode when he or she needs to perform ACD-related activities, such as filling out a form as a result of an ACD call. The agent is unavailable for ACD calls to all splits while in ACW mode. Switch administration determines whether the agent remains in the Most Idle Agent queue while in ACW.

When an agent is in the Manual-In mode and disconnects from an ACD call, he or she automatically enters ACW mode. Although no longer available for ACD calls, the agent is still available for non-ACD calls. CMS or BCMS is notified whenever an agent in ACW mode receives an incoming non-ACD call or makes an outgoing call.

## Timed After Call Work

With Timed ACW administered, an Auto-In agent is immediately placed in ACW mode for a specific length of time after completing the currently-active ACD call. When the Timed ACW interval expires, the agent automatically returns to the Auto-In work mode. If the agent activates ACW while not on a call, the agent is placed in ACW (not timed) mode regardless of whether the agent is in Auto-In or Manual-In mode.

Use Timed ACW to allow agents to rest between incoming ACD calls, or to pace agents when they have to complete work from the previous call within an allotted time. In addition, if you have Home Agent, use Timed ACW to allow agents additional time to dial a FAC to place themselves in a different work mode after the current ACD call is completed.

## Timed ACW and VDN

You can administer Timed ACW for all calls to a split/skill and/or to a VDN. Any completed calls to the split/skill or to the VDN, including direct agent calls, are followed by a timed ACW when the answering agent is in Auto-In work mode. If a VDN call routes to a split/skill, the Timed ACW interval for the VDN overrides the Timed ACW interval for the hunt group. VDN override applies to VDN-Timed ACW.

## Cancelling Timed ACW

When an agent activates Auto-In or Manual-In mode during Timed ACW, the agent becomes available and timed ACW is cancelled. An agent can change to Manual-In mode before or during a call. The system cancels Timed ACW and applies ACW (not timed) mode when the call is released. The agent remains in ACW until he or she requests another mode. When the agent releases an ACD call, the ACW lamp (if provided) lights. At the end of the administered Timed ACW interval, the ACW lamp goes dark and the Auto-In lamp lights.

Timed ACW also is canceled when an agent presses the ACW button or dials the ACW FAC.

If an agent activates Auxiliary Work mode during Timed ACW, the agent is placed in that mode and Timed ACW is cancelled.

## Agent request for supervisor assistance

To request assistance from the split supervisor, an agent, with or without an active ACD call, presses the Assist button or puts the call on hold and dials the Assist FAC plus the split number. The agent must be logged into the split. Assist generates 3-burst ringing at the supervisor's station. If a split supervisor is not assigned, the agent receives intercept tone.

Attendants should press the Start button before pressing the Assist button. This allows them to later transfer the call. This rings like a priority call at the supervisor's set.

When the agent presses the Assist button, the following happens:

1. If the agent is active on an ACD call, the ACD call is automatically placed on hold and a call is placed to the split supervisor. If the agent is not active on an ACD call, a call is automatically placed to the supervisor.
2. CMS or BCMS is notified of the request and the supervisor's display shows that the call is a request for assistance. This rings like a priority call at the supervisor's set.
3. The caller hears silence or music on hold.
4. After the agent has talked to the supervisor, the agent can drop the assist call and return to the ACD call, set up a conference call with the supervisor and the calling party, or transfer the call to the supervisor.

When the agent puts the call on hold and dials the Assist FAC plus the split number, the system handles the request as if the agent pressed the Assist button, except that the Assist call does not follow the supervisor's coverage path.

## Stroke counts

Stroke counts allow you to record in CMS the number of times that a particular customer-related event occurs. For example, agents could press a button each time a customer requests information on a certain item.

Stroke counts are reported to CMS in real time. The system does not store stroke counts. Use stroke counts only when CMS is connected and you have defined ACD splits to be measured by CMS.

Stroke counts allow agents to record up to nine administrator-defined events on a per-call basis. You can assign 10 Stroke Count button types. Stroke Count 0 is reserved for tracking Audio Difficulty or poor transmission quality.

For troubleshooting purposes, CMS records the equipment location of the trunk that the agent was using when he or she pressed the Audio Difficulty button.

Make sure that agents are aware that pressing this does not improve audio transmission quality.

To enter a stroke count, an ACD agent presses a Stroke Count button while off-hook. The system validates that the agent is either active on an ACD call or in the ACW mode for an ACD split. If yes, the feature lamp lights steadily for two seconds to indicate activation and the stroke count is sent to CMS. If not, the feature lamp flutters and no message is sent.

## Call work codes

Call work codes are up to 16-digit sequences that ACD agents enter to record such customer-related information as account codes, social security numbers, or phone numbers. You define the codes for your site. Codes that agents enter are sent to CMS for storage for splits measured by CMS and only when the link to the CMS is up. Agents must have multiappearance voice terminals (for example, CALLMASTER) to enter call work codes.

To enter call work codes, the agent must be off-hook and either:

- On an ACD call
- In ACW mode after disconnecting from a call while in Manual-In mode
- In Timed ACW after disconnecting from a call while in Auto-In mode
- In Auto-In mode and pending for ACW mode

The sequence of event is as follows:

1. The agent select Call Work Code (CWC) button.
2. The CWC lamp lights steadily and a C: prompt appears on the agent's display. The agent must wait for the ready indication before entering the call work code or the caller hears the touch-tone digits being dialed.
3. Agent enters up to 16 digits on the dial pad. The agent can press \* to erase digits.
4. The agent presses # to send the code entry to CMS.
5. The Call Work Code lamp goes dark and the display returns to normal.
6. If the agent presses any feature button or hangs up during digit collection, the code entry is cancelled and data is sent to CMS. The CWC lamp goes dark and the display is cleared.

Call work codes may be used by as many as 100 agents simultaneously. If 100 agents are simultaneously using this function, and another agent attempts to enter a call work code, the agent receives a display message to try again later.

## Forced entry of stroke counts and call work codes

You can administer a split so that agents must enter a stroke count and/or a call work code before becoming available for another call using Manual-In mode.

 **NOTE:**

Multiappearance voice terminals or an attendant console are required for agents to enter stroke counts or call work codes.

To enter a stroke count and/or call work code, the agent must be on a call, or in ACW mode after releasing a call in Manual-In mode.

After releasing a call, the agent automatically enters ACW mode and cannot return to Manual-In mode until entering a stroke count or call work code. If the agent presses the Manual-In button or FAC before entering a stroke count or a call work code, the Manual-In lamp flutters or intercept tone is given.

Once the agent enters a stroke count or call work code and presses the Manual-In button or FAC, he or she returns to Manual-In mode and the Manual-In lamp lights.

Any of the agent's splits can have Forced Entry assigned. If the agent goes into Auxiliary Work mode in any split, the Forced Entry requirement for all other splits is removed.

## Expanded technical information

### Agent capacity and related limits

Agent Sizing adds an overriding capacity limit to the number of logged-in ACD agents. It can be used to limit the number of logged-in ACD agents to a number less than (or equal to) the maximum supported by the system configuration.

The logged-in ACD agents limit applies to ACD agents in traditional (or non-EAS) ACD splits or in Expert Agent Selection (EAS) skills. Auto-Available Split/Skill (AAS) agent ports are logged in and counted when they are first assigned, while the non-AAS agents are counted when they actually log in. Each logged-in agent is counted as a single agent independent of the number of splits or skills logged in to for the Logged-in ACD agents limit. AAS and non-AAS agents are counted towards this limit whether they are BCMS/CMS measured or not.

The agent sizing limit is administered by authorized Lucent Technologies personnel via the Logged-in ACD Agents option on the System-Parameters Customer-Options form. The maximum number of allowed logged-in ACD agents is set to correspond to the configuration you purchase.

For agent sizing, if you have agents working in shifts, you should purchase enough agent capacity to allow for a smooth shift change. If agents on a subsequent shift are logging in before agents in the previous shift have logged out, agents could be denied login because too many agents are currently logged in. Additionally, the non-ACD and/or non-agent (AAS/VRU) use of Hunt Group resources must be considered. Call Center managers need to be aware of their logged-in ACD agent and other related limits when adding agents to handle a

traffic peak or when planning a special campaign. Some of the resource utilization is displayed dynamically on the Display Capacities form.

Note that under certain configurations, the limit set in the Logged-In Agents field cannot be reached due to some other system limit being reached. In particular, note that the ECS R5r and later configurations with EAS only supports up to 500 agents logged in if each has the maximum 20 skills assigned due to the 10,000 Hunt Group member limit.

In addition to the logged-in ACD agents limit, the number of agents supported is dependent on the upper limits that the system platform supports. The following limits must also be considered.

- Maximum Hunt Group members
  - Non-ACD members include hunting groups with or without queues, Message Center Service groups, INTUITY/AUDIX groups and Remote AUDIX groups (see [“Hunt Group” on page 5-158](#)). Each line or port in a group is counted once when assigned.
  - ACD members (also called agent-split pairs or agent-skill pairs with EAS). For agents in multiple splits/skills, each combination (pair) is counted as a member (e.g., an EAS agent logged into 4 skills or a non-EAS agent assigned to 4 splits counts as 4 members). Non-EAS ACD members are counted when assigned (note that many more splits can be assigned to an agent than can be logged into but each agent-split pair is still counted towards the limit). EAS ACD members are counted when they log in.
- Hunt Group members per group — Count of non-ACD or ACD members within a group/split/skill. Counting is done as above for maximum Hunt Group members.
- Additional traditional ACD (non-EAS) agents limits:
  - Maximum logged-in agents system limit
  - Maximum splits an agent can log into
- Additional EAS limits:
  - ACD members (skill pairs) administered — Limits skill assignments to agents (each AAS port is counted as one skill pair)
  - Agent Login IDs Administered — Limits number of AAS ports and EAS agents that can be pre-assigned
  - Agent Login IDs Logged-In (staffed) system limit — Upper limit on the number of EAS agents (and AAS ports) that can be logged-in simultaneously
  - Skills per Agent — The maximum number of skills a particular agent can be assigned

- Call Management System (CMS) logged in ACD members (agent-split/skill pairs) limits assigned. Both a Lucent Technologies setup and customer-administered limit is assigned in CMS. These limits are related to the CMS memory/hardware configuration equipped and are passed over the link to the DEFINITY switch to reduce/set the externally measured logged-in ACD member component of the Hunt Group member limit to that supported by CMS.
- BCMS internally measured ACD agents system limit. Non-EAS ACD agents counted when assigned while EAS agents are counted when logged in.

When the maximum number of ACD agents are logged in or any of the other above limits are reached, an agent who attempts to log in hears reorder tone or is otherwise denied log in. Also with EAS, an agent logging in may not have all the assigned skills logged in if the ACD member limit is reached.

The administrator of a non-EAS system also can be blocked from adding agents to splits via the Hunt Group form or the administrator of an EAS system can be blocked from assigning additional Login IDs or skills to an agent via the Login ID form if the relevant system limits are reached.

## Considerations

---

Release button

Agents using Automatic Answer are logged out of all splits when they disconnect from an ACD call by hanging up. Therefore, agents should use the Release button, if provided. This button is in addition to the fixed Release button on the attendant console.

## Timed ACW

To prevent agents from canceling Timed ACW by pressing the Manual-In or ACW buttons, do not assign these buttons to the agents' voice terminals. Timed ACW cannot be assigned to AAS, adjunct-controlled, AUDIX, Remote AUDIX, or Message Center splits. In addition, VDN-Timed ACW does not apply to calls routed to a converse split by way of the *converse-on* vector command. Timed ACW assigned to a converse split hunt group applies.

BCMS and CentreVu CMS track Timed ACW as standard ACW work states. Time spent in Timed ACW is not specifically identified.

## Nonvector-controlled splits

For nonvector-controlled splits, the last available agent in a split cannot enter Auxiliary Work mode if any calls remain in the split queue. (However, the agent can log out.)

When the last available agent tries to enter Auxiliary Work mode, the following occurs:

- The Auxiliary Work button flashes indicating the change is pending.
- New calls on the ACD split either receive busy tone or redirect to coverage. Calls in the queue continue to route to the last available agent until the queue is empty.
- At the last available voice terminal or console, the Auxiliary Work button lamp flashes until the queue is empty. The terminal then enters Auxiliary Work mode and the associated lamp lights steadily.

### **Agents logged into multiple splits**

If an agent is logged into multiple splits, the agent may become unavailable for calls to one split because of activity at another split. For example, if an agent enters After Call Work mode for one split, the agent becomes unavailable for calls to other splits.

An agent should not log into a split while a call is on hold at his or her extension.

### **Agents with Automatic Answer**

Agents who use Automatic Answer should use a headset. The agent hears zip tone through the headset and automatically connects to a call.

If either the incoming trunk group or the agent's extension is data-restricted, the agent does not hear zip tone. Therefore, do not assign data-restriction to a headset user's extension.

It is not recommended that you use Automatic Answer with a handset or speakerphone. The handset or speakerphone must be off-hook (handset lifted or speakerphone turned on) all the time for the agent to hear zip tone.

If automatic answer is assigned for all calls, when a non-ACD call arrives, non-ACD Auto-Answer agents hear Incoming Call ID tone, not ringing.

### **CALLMASTER terminals**

Calls for CALLMASTER digital voice terminals and attendant stations are announced by double tones. The tones that are doubled are zip (Auto-Answer ACD agent calls) and Incoming Call ID (for End of VDN of Origin announcements and all other Auto-Answer calls). The user hears part of the first tone and all of the second tone.



## Agents assigned to hunt-group and ACD calls

Do not use agents for hunt-group calls and ACD split calls simultaneously. Otherwise, all of the calls from one split (either ACD or hunt-group) are answered first.

The oldest call-waiting termination is supported only for agents who are servicing ACD calls only.

## Interactions

---

- **Abbreviated Dialing**

Assign Abbreviated Dialing buttons to make agent login easier. You can program an Abbreviated Dialing button to dial access code, split number, and/or agent login ID. With DEFINITY switches (R4 or later) you can use Autodial feature buttons to assign log and logout feature buttons.
- **Auto-Available Split (AAS)**

An AAS cannot be administered for Timed ACW.
- **Bridging**

ACD split/skill calls are not bridged.

Station calls are bridged and agents are able to bridge onto them. If an agent bridges onto a call, the call is considered a non-ACD extension-in call. The agent is not available for an ACD call unless the agent is a member of a many-forced, one-forced, or one-per-skill MCH split/skill. The agent can put the call on hold and become available to receive ACD calls even in non-MCH splits/skills if only bridged appearances are active.
- **Call Coverage**

If an ACD call routes to an agent as a result of covering to a VDN (where the VDN is the last coverage point in the coverage path), Timed ACW applies as administered for the VDN or split/skill.
- **Call Forwarding**

If an ACD call routes to an agent after being call-forwarded to a VDN, Timed ACW applies as administered for the VDN or split/skill.
- **Call Pickup**

When an ACD agent answers a call via Call Pickup, the call is treated as an incoming non-ACD call. The agent can put the call on hold and become available for additional calls.
- **Call Work Codes**

The call work code 100-agent limit is shared with Reason Codes. Therefore, no more than 100 agents can simultaneously enter either a call work code or reason code.

- CallVisor ASAI Adjunct

If a split/skill hunt group has CallVisor ASAI as the controlling adjunct, you cannot administer Timed ACW for the split/skill. Additionally, if an ACD call is routed to an agent in an adjunct-controlled split/skill, the agent is not placed in Timed ACW when the call ends.

- CentreVu CMS

Timed ACW is reported on CMS reports in the same way as any other ACW. CMS gives exception notification only on ACW intervals that are longer than the defined threshold.

- Conference

If an agent receives an ACD call through a VDN and then conferences in other agents, the agents added to the call use the Timed ACW interval associated with the number dialed to conference them.

An ACD agent on conference with more than three parties may cause inaccurate CMS measurements.

- Expert Agent Selection

When EAS is active, all ACD hunt groups are assigned as vector-controlled skills. Agents log in using Logical Agent IDs. Skills can be preassigned to login IDs, however, assignment on the Login ID form does not actually assign a non-AAS login ID to the skills until the ID is logged in. When the login ID is logged in, each skill is counted as a hunt-group member towards the system hunt-group member limit, the per-group member limit, and each agent is counted as a logged-in ACD agent.

- Multiple Call Handling

If MCH calls are on hold at an agent's terminal and the agent completes a call that normally is followed by Timed ACW, the agent is not placed in ACW. If no MCH calls are on hold, but one is alerting at the station when the Timed ACW call completes, the agent is placed in ACW.

MCH affects when agents can enter different work modes and when calls are delivered to agents in Manual-In or Auto-In work modes. See [“Multiple Call Handling” on page 9-104](#) for detailed information.

- Transfer

If an agent receives an ACD call through a VDN and then transfers the call to another agent, the second agent uses the Timed ACW interval assigned to the number that was dialed to transfer the call.

For an EAS agent, this is the Timed ACW interval associated with his or her Direct Agent skill. For an agent receiving a call transferred to a second VDN, this is the VDN Timed ACW interval of the second VDN. The agent who originally transferred the call uses the ACW associated with the VDN or split/skill that first received the call.

- VDN Override

If a VDN has VDN Override set to no and the vector routes a call to a second VDN, the first VDN's Timed ACW interval is used for Timed ACW. If VDN Override is set to yes, the second VDN's Timed ACW interval is used.

If no interval is set for the second VDN, no Timed ACW is associated with the call.

- Voice Response Integration

If an ACD call routes on a *converse* vector command, any VDN-Timed ACW associated with the call is ignored for agents in the converse split/skill. However, if the converse split/skill has an administered Timed ACW interval, the answering agent associated with the split/skill is placed in Timed ACW when *converse* vector command processing completes.

## Auto-Available Split

---

Auto-Available Split (AAS) allows members of an ACD split to be in Auto-In work mode continuously. An agent in Auto-In work mode becomes available for another ACD call immediately after disconnecting from an ACD call.

Use AAS to bring ACD-split members back into Auto-In work mode after a system restart. Although not restricted to such, this feature is intended to be used for splits containing only nonhuman members — for example, recorders or voice-response units (VRUs).

### How to administer AAS

---

#### Required forms

---

| Form                     | Field | Page                  |
|--------------------------|-------|-----------------------|
| Hunt Group               | ■ AAS | <a href="#">5-158</a> |
| Agent LoginID (EAS only) | ■ AAS | <a href="#">9-193</a> |

ACD must be set as a system option and the ACD field on the Hunt Group form must be set to **y**.

### Detailed description

---

- Agent login with AAS

With AAS, ACD splits generally operate as usual. The major difference is in how work modes are handled.

For ACD splits with AAS, agents are automatically logged in under the following circumstances:

- Call Management System (CMS) completes an Agent Move request into an Auto-Available split.
- A maintenance-busied-out port, which is defined as an agent in an Auto-Available split, is released.
- The system reinitializes and requires agents to log in again.
- You administer a split on the Hunt Group form as AAS = y.
- You administer an agent into an existing AAS split.

Once an agent is logged into an Auto-Available split, it is immediately moved to the Auto-In work mode and subsequent requests to change out of that mode are denied.

- Agent logout with AAS

For ACD splits with AAS, agents are automatically logged out under the following circumstances:

- CMS completes an Agent Move request out of an Auto-Available split.
- The Auto-Available agent's port is unavailable because maintenance is being performed.
- You administer a split as AAS = n.
- You remove an agent from an existing AAS split.
- Redirection on No Answer (RONA) redirects a call that the agent has not answered after an administered number of rings.

## Considerations

---

- AAS is intended primarily for non-BX.25 and non-ASAI PBX adjuncts such as Conversant VIS, that require extra help in getting PBX ports back online after a restart. AUDIX is incompatible with AAS because it uses BX.25 messages to automatically activate its ACD agent ports after a PBX restart.
- Because AAS is intended for nonhuman agents, do not administer an Auto-Answer terminal as a member of an AAS.
- AAS is not intended for any agent port hardware that can change its work mode state since a request to move to any state other than AUTO-IN is denied; however, administration of such terminals is not blocked.

## Interactions

---

- Auto-Answer

Do not administer an Auto-Answer terminal as a member of an AAS.

Auto-Answer was originally implemented for human agents. Currently, if a nonanalog terminal is administered as Auto-Answer and that terminal is logged into a split, when the terminal goes on-hook, the terminal is logged out.

Agents at analog terminals defined as Auto-Answer who are logged into a split must dial a log-out FAC to log out. If a terminal is a member of an AAS, a log-out FAC is denied. To log the agent out, you must either remove the terminal from the split when it is not active on a call or busy-out the terminal.

If an agent in an AAS with an Auto-Answer terminal goes off-hook, his or her terminal is logged into any Auto-Available splits of which it is a member. To log out of the AAS splits, the agent goes on-hook, is placed in AUX work mode, and then presses the RELEASE button on nonanalog

sets or disconnects on analog sets. Because agents are not placed immediately in Auto-In work mode, they may place personal or emergency calls rather than answering ACD calls that may be in queue.

- **CMS**

For each agent, AAS notifies CMS of any login, logout, or change into the Auto-In work mode. In a non-EAS environment, an AAS agent is identified to CMS with a login ID equivalent to the agent's administered extension. With EAS, the AAS login ID and port are assigned on the Login ID form.

With CMS Move Agent, you can move a member from one AAS split to another while that member is logged in.

## Automatic Call Distribution

---

Automatic Call Distribution (ACD) allows incoming calls to connect automatically to specific splits. An ACD split is simply a hunt group that is designed to receive a high volume of similar calls. Calls to a specific split are automatically distributed among the agents, or hunt group members, assigned to that split. Calls queue to the split until an agent is available.

An ACD agent can be a voice-terminal extension, individual attendant extension, or, in an Expert Agent Selection (EAS) environment, an agent login ID. An agent can be logged into multiple splits. However, in a non-EAS environment, agents can be logged into only one split if that split is administered for Multiple Call Handling (MCH).

You can assign a supervisor to each split. The split supervisor can listen in on agent calls, monitor the split queue status, and assist agents on ACD calls. Although split supervisors can assist agents on ACD calls, the supervisors do not normally receive ACD calls unless they are also members of the split.

If you have Call Management System (CMS) or Basic Call Management System (BCMS), you can measure and create reports on the status of ACD agents, splits, and trunks. See [“Agent Call Handling” on page 9-7](#) and [“Call Management System” on page 9-58](#) or [“Basic Call Management System” on page 9-40](#) before setting up your ACD splits. See [“Agent Call Handling” on page 9-7](#) for detail on administering agent functions and operations.

[Figure 9-26](#) shows an a typical ACD arrangement.

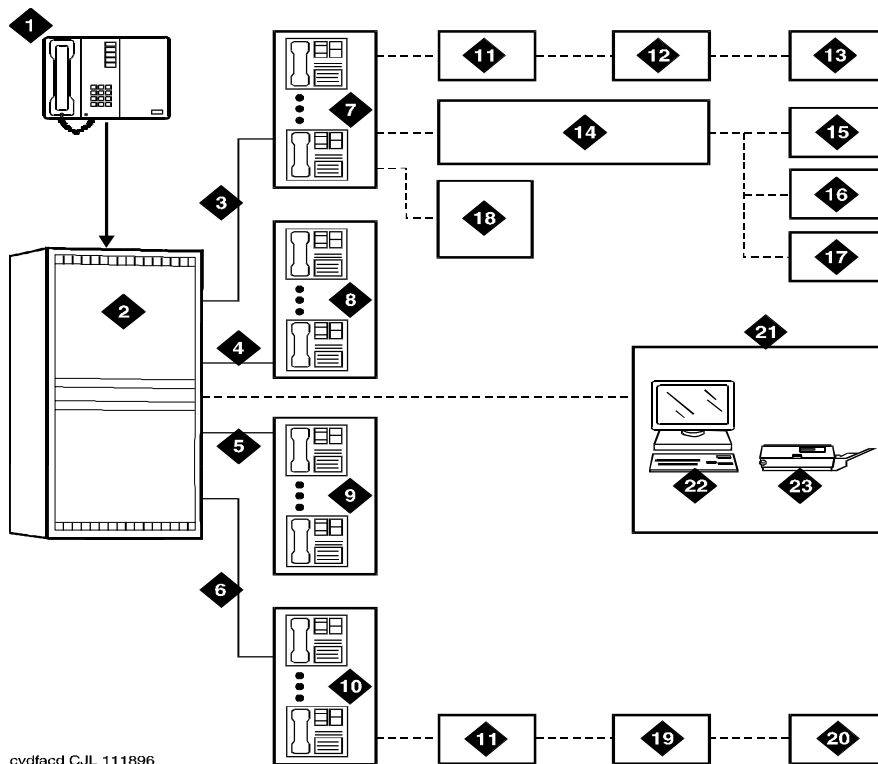

cydface C.JL 111896

**Figure Notes**

- |   |  |
|---|--|
| 1. Incoming calls                           | 13. Announcement 2                           |
| 2. ACD switch                               | 14. Intraflow (Call Coverage)                |
| 3. Trunk group 1                            | 15. Split 2 Personal Travel (3rd choice)     |
| 4. Trunk group 2                            | 16. Split 3 Group Travel (2nd choice)        |
| 5. Trunk group 3                            | 17. Split 4 General Information (1st choice) |
| 6. Trunk group 4                            | 18. Supervisor (with Service Observing)      |
| 7. Split 1 Business Travel (10 agents)      | 19. Announcement                             |
| 8. Split 2 Personal Travel (8 agents)       | 20. Disconnect                               |
| 9. Split 3 Group Travel (5 agents)          | 21. Call Management System (CMS)             |
| 10. Split 4 General Information (15 agents) | 22. Terminal                                 |
| 11. Queues                                  | 23. Printer                                  |
| 12. Announcement 1                          |  |

**Figure 9-1. Typical ACD Arrangement**



## **How to administer ACD**

---

### **Required forms**

---

| <b>Form</b>                       | <b>Field</b>  | <b>Page</b>           |
|-----------------------------------|---|-----------------------|
| Trunk Groups                      | <ul style="list-style-type: none"> <li>■ Incoming Destination</li> </ul>  | <a href="#">7-115</a> |
| CO                                |   |                       |
| FX                                |   |                       |
| Tie                               |   |                       |
| WATS                              |   |                       |
| Class of Restriction              | <ul style="list-style-type: none"> <li>■ Can Be Service Observer? (optional)</li> <li>■ Can Be Service Observed? (optional)</li> </ul>  | <a href="#">5-72</a>  |
| Attendant Console                 | <ul style="list-style-type: none"> <li>■ Headset, Auto Answer</li> </ul>  | <a href="#">5-35</a>  |
| Station                           | <ul style="list-style-type: none"> <li>■ Headset, Auto Answer</li> <li>■ Button Assignments - Work-Mode, Queue Status, Call Info</li> </ul>   | <a href="#">6-28</a>  |
| Hunt Group                        | <ul style="list-style-type: none"> <li>■ All</li> </ul>   | <a href="#">5-158</a> |
| Feature-Related System-Parameters | <ul style="list-style-type: none"> <li>■ Service Observing (optional)                             <ul style="list-style-type: none"> <li>— Service Observing Warning Tone</li> <li>— Service Observing by FAC</li> </ul> </li> <li>■ Most Idle Agent                             <ul style="list-style-type: none"> <li>— MIA Across Splits or Skills</li> <li>— ACW Agents on MIA List</li> </ul> </li> <li>■ Call Management System                             <ul style="list-style-type: none"> <li>— ACD Login Identification Length</li> </ul> </li> </ul> | <a href="#">5-123</a> |
| Feature Access Code (FAC)         | <ul style="list-style-type: none"> <li>■ Automatic Call Distribution page</li> <li>■ Announcement Access Code</li> <li>■ Service Observing Listen Only or Listen/Talk Access Code (optional)</li> </ul>   | <a href="#">5-113</a> |
| Announcements/ Audio Sources      | <ul style="list-style-type: none"> <li>■ All</li> </ul>   | <a href="#">5-26</a>  |

- Trunk Group forms — In the Group Number field, assign consecutive Group Numbers to trunk groups when you are using two or more trunk groups to support ACD applications.
- Hunt Group form — When the ACD field is set to y, complete the fields that apply. In the AAS field, enter **y** to enable Auto-Available Split. See [“Auto-Available Split” on page 9-22](#) for more information.

## Detailed description

You can administer an ACD split to use one of three methods to select an available agent:

- Direct Department Calling
- Uniform Call Distribution
- Expert Agent Distribution

### Direct Department Calling

If you administer a split for Direct Department Calling (DDC), an incoming call is routed to the first available agent extension in the administered sequence. If the agent is not available, the call routes to the next available agent, and so on. Incoming calls are always routed to the first agent in the sequence, so calls are not evenly distributed among agents. DDC is not available with EAS.

### Uniform Call Distribution

Uniform Call Distribution (UCD) uses the Most-Idle Agent (MIA) algorithm to route calls. The MIA algorithm creates a queue of agents who are available to receive calls. An incoming call is routed to the agent who has waited the longest time in the queue. When an agent receives a call, the agent is removed from the queue for the split/skill to which the call was delivered. If MIA Across Splits/Skills is active, the agent is also removed from all other agent queues. Otherwise, the agent remains in the MIA queue for any other splits/skills that he or she is logged into.

The agent is returned to the agent queue (or queues if MIA Across Splits/Skills is active), based on how you administer the following:

- If forced Multiple Call Handling applies, the agent is placed in the queue when the call stops alerting.
- If ACW Agents on MIA List is enabled, the agent is queued when the call completes.
- If ACW Agents on MIA List is disabled, the agent is queued when ACW completes.

UCD distributes calls evenly among agents logged in to a particular split/skill. UCD with MIA Across Splits/Skills distributes calls evenly among agents logged into the same splits/skills.

## Expert Agent Distribution

Expert Agent Distribution (EAD) is available only with Expert Agent Selection (EAS). EAD also uses the MIA algorithm to route calls but maintains a queue of idle agents by agent skill level.

When you are using EAS Preference Handling Distribution (EAS-PHD), the agent can enter the MIA queue at one of 16 levels. The lower the level, the higher the level of expertise; so an agent with skill level 1 is the most qualified to answer a call to that skill. Without EAS-PHD, agents enter the MIA queue as either level 1 or level 2 agents.

When agents with a lower skill level become idle, they enter the MIA queue in front of agents with a higher skill level. See [“Expert Agent Selection” on page 9-72](#) for more information about EAS Call Distribution.

## Queuing and announcements

You create a queue for an ACD split by setting Queue to **y** on the Hunt Group form. When all agents are active on calls or in After-Call Work mode, the queue allows incoming calls to wait for an idle agent. The next available agent is automatically connected to the call in the split queue.

For non-vector-controlled splits, calls do not queue to splits in these cases:

- No agents are logged in
- All logged-in agents are in Auxiliary Work mode
- No queue slots are available

The caller gets a busy signal (or busy coverage, if administered) unless a call comes in via an automatic-in central office (CO) facility. In this case, the caller hears ringback from the CO and the system continues trying to place the call in the queue.

You can assign two announcements to each split and administer a second announcement to repeat. When an incoming call is directed to an ACD split, the call is either directed to an agent or is automatically connected to the first announcement. See [“Announcement rules” on page 9-32](#) in this section for information on how announcements are affected by call forwarding and call coverage.

### First announcement

After a call enters a split queue, the caller hears ringing and the first announcement delay interval begins. If an agent becomes available during the first announcement delay interval, the call is connected to the agent. Otherwise, the interval expires and the system tries to connect the incoming call to the first announcement, with one of the following results:

- If the first announcement is available, the caller hears ringing, then the first announcement.
- If the announcement is busy and has no queue, the caller hears ringing and the first announcement delay interval is reset. The system tries to access the announcement again when the interval expires.
- If the announcement is busy and has a queue, then:
  - If the queue is full, the caller hears ringing and the first announcement delay interval is reset. The system tries to access the announcement again when the interval expires.
  - If the queue is not full, the call enters the announcement queue and the caller hears ringing, then the first announcement. The system then tries to connect the call to an agent.
- If the announcement is not busy, but is still unavailable, the second-announcement delay interval begins and the system attempts to connect the call to the second announcement.

If there is no first or second announcement, the call remains in queue until answered or removed from the queue.

### Forced first announcement

The first-announcement delay interval defines how long a call remains in queue before the call is connected to the first announcement. If this interval is 0 seconds, the incoming call is automatically connected to the first announcement. This is a forced first announcement — the call is not routed to an agent until after the caller hears the first announcement.

With a forced first announcement, the following occurs:

- If a first announcement is available, the caller hears ringing and then the first announcement. The system then tries to connect the call to an agent.
- If the announcement is busy and has no queue, the system waits 10 seconds and then tries to access the announcement.
- If the announcement is busy and has a queue, then:
  - If the queue is full, the system waits 10 seconds, then tries to access the announcement.
  - If the queue is not full, the call enters the announcement queue and the caller hears ringing, then the first announcement. The system then tries to connect the call to an agent.
- If the announcement is not busy but is still unavailable (for example, it may have been deleted), then the system tries to connect the call to an agent.

After a forced first announcement, the caller always hears ringback (or music-on-hold, if administered) until the call is answered or is connected to a second delay announcement. After a first or second delay announcement, the caller hears music-on-hold, if administered.

## Second announcement

After the first announcement, the second-announcement delay interval begins and the caller hears ringing (if there is no forced first announcement), or music, if provided. If an agent becomes available during the interval, the call is connected. Otherwise, the interval expires and the system tries to connect the incoming call to the second announcement, resulting in one of the following:

- If the second announcement is available, the caller hears ringing or music, then the second announcement.
- If the announcement is busy and has no queue, the caller hears ringing and the second-announcement delay interval is reset. The system tries to access the announcement again when the interval expires.
- If the announcement is busy and has a queue, then:
  - If the queue is full, the caller hears ringing (only if the first announcement has not been heard) and the second-announcement delay interval is reset. The system tries to access the announcement again when the interval expires.
  - If the queue is not full, the call enters the announcement queue and the caller hears ringing (only if the first announcement has not been heard), then the second announcement. The system then connects the call to an agent.
- If the announcement is not busy but is still unavailable, the call remains in queue until answered or removed from the queue.

After the second announcement, the caller hears music, if provided, or silence and then:

- If you administered the split to repeat the second announcement, the system tries to connect the call to the second announcement after the delay expires.
- If you administered the split not to repeat the second announcement, the call remains in the queue until answered or removed from the queue.

## Forced disconnect

You can connect an incoming call directly to an announcement and then disconnect the call after the announcement has completed in one of two ways:

- Administer an announcement extension as the incoming destination. The caller is directed to the announcement and is disconnected, without being queued for a split.
- Administer an announcement extension as a point in a split's coverage path. Calls that have been in the queue for a long time are forced to go directly to the announcement and are disconnected.

## Announcement rules

The following rules govern announcements a caller hears:

- Calls that reach a split directly always hear a forced first announcement, if assigned, regardless of subsequent call coverage, call forwarding, night service, or busy signal processing. If these calls queue long enough, they hear first and second announcements.
- Calls that reach a split via call coverage receive a second announcement only, if administered. The assumption is that a caller has likely heard a first announcement at the original split or station before being redirected.
- Calls that reach a split via call forwarding receive first and second announcements at the destination split, if administered. These calls can receive a forced first announcement at the original split, if administered, but not at the split they are forwarded to.

## Entering the queue

When a forced first announcement is not assigned, the system tries to connect an incoming call to an available agent. If an agent is available, the call is connected to the agent. If all agents are active (either on an ACD call or in ACW mode), the call enters the split queue.

If no queue is assigned, or if no queue slots are available and the incoming facility is a CO trunk, the caller hears ringing. The system continues trying to queue the call until a queue slot becomes available, or until the call is abandoned or an agent becomes available. When you have administered Intraflow and Interflow with Call Coverage and Call Forwarding All Calls, the caller hears a busy tone or the call is redirected in any of these cases:

- No split queue is assigned.
- The queue is full.
- No agents are logged in.
- All logged-in agents are in AUX work mode, and the incoming facility is a digit-oriented facility (digits are sent to the PBX as in DID, incoming wink, or immediate tie trunks)

### NOTE:

Central office trunk (non-DID) calls receive ringback from the CO, so the PBX cannot give these callers a busy signal. The system tries to put such calls into queue until successful or until the call is abandoned.

## Priority queuing

Priority queuing allows priority calls to be queued ahead of calls with normal priority. You can implement priority queuing in two ways:

- Assign Priority Queuing to a calling party's Class of Restriction (COR).
- Assign Priority on Intraflow to an ACD split. This allows calls from the split, when intraflowed into another split, to be queued ahead of nonpriority calls. For more information, see ["Information Forwarding" on page 9-89](#).

## Queue status indications

You can assign queue status indications on agents' or supervisors' terminals or consoles for ACD calls in queue. For more information, see ["Queue Status Indications" on page 9-110](#).

## Direct Agent Calling



### NOTE:

Direct Agent Calling requires CallVisor Adjunct-Switch Application Interface (ASAI) or EAS. Both originating and called party Class of Restrictions (CORs) must be set to allow Direct Agent Dialing. See ["Expert Agent Selection" on page 9-72](#) for information on Direct Agent Announcements.

Direct Agent Calling (DAC) causes a call to a particular ACD agent to be treated as an ACD call. Agents can enter After Call Work mode for direct agent calls and CMS and BCMS correctly measure these calls as ACD calls.

If an agent is available to answer an ACD call, the direct agent call is delivered to the agent. An agent in Automatic Answer mode hears a zip tone.

An agent with a multifunction voice terminal or who is on-hook and not available to answer an ACD call hears a ring-ping. An agent with a single-line voice terminal and who is off-hook and not available hears the call-waiting tone, even when Call Waiting Termination is not assigned. The ring-ping or call waiting tone is given only once per call when the direct-agent call is queued. The lit work mode button lamp for the split on the agent's voice terminal flashes, indicating that a direct agent call is waiting. Flashing starts when the call queues and stops when all direct agent calls are removed from the queue (that is, they are answered, abandoned, or sent to coverage).

While on a direct-agent call, the agent becomes unavailable for subsequent ACD calls. If the agent logs off by unplugging the headset, he or she can still answer a direct-agent call in the queue by logging back in and becoming available. Agents who have direct-agent calls waiting are not allowed to log off using a FAC. If the agent is in Manual In mode or pushes the After Call Work (ACW) button while on a direct-agent call, the agent goes to ACW mode.

Generally, direct-agent calls are queued and served in first-in, first-out order before other calls, including priority calls. However, if you administer a skill level for Call Handling Preference, direct-agent calls must be assigned the highest priority for them to be delivered before other ACD calls. Otherwise, calls with a higher skill level are distributed before direct-agent calls.

Note that you can use Multiple Call Handling (MCH) to allow agents to answer a direct agent call with another ACD call active.

Direct-agent calls follow the receiving agent's coverage and call forwarding paths, if these features are administered. Once a call goes to coverage or is forwarded, the call is no longer treated as a direct-agent call, and CMS is informed that the call has been forwarded.

## **Considerations**

---

### **Maximum Number of Agents**

If an agent is assigned to more than one split, each assignment applies to the maximum number of agents. When computing the number of agents measured by BCMS, count one agent as one agent regardless of the number of splits that the agent will be logged into. For CMS sizing, count one agent for each agent in each split measured by CMS; one agent logged into three splits counts as three agents.

Using the Number of Agents System Capacity screen, you can view the Used, Available, and System Limit counts.

### **MIA Across Splits/Skills**

MIA Across Splits/Skills distributes calls more equally to agents with multiple splits or skills. When agents handle a call for one split or skill, they go to the back of all their idle agent lists.

With MIA Across Splits/Skills, agents may not receive calls from all of their splits/skills. If, for example, split 20 has a very short average agent idle time and split 22 has a very long average agent idle time, agents with both of these skills may never become the most-idle for skill 22 because they continuously take calls for split 20.

### **Announcements**

Announcements can be analog, aux trunk, DS1, or integrated. Integrated announcements use the 16-channel announcement board and queuing is based on whether one of the 16 channels is available. When a channel becomes available, any announcements on the board can be accessed, including the announcement already being played. A caller may be in queue for an announcement because a channel is not available, even though that



announcement is not being used. The maximum queue length for all digital announcements is shown in the Capacities Table in the *DEFINITY Enterprise Communications Server Release 6 System Description Pocket Reference*. Queues for analog and aux trunk announcements are on a per-announcement basis. You can also install multiple Integrated Announcement boards to allow for more announcements.

If a delay announcement is used, answer supervision is sent to the distant office when the caller is connected to the announcement. Charging for the call, if applicable, begins when answer supervision is returned.

## Storing and retrieving messages

Leave Word Calling messages can be stored for an ACD split and retrieved by a split member, a covering user of the split, or a system-wide message retriever. The message retriever must have a voice terminal display and proper authorization. You can also assign a remote Automatic Message Waiting lamp to a split agent's terminal to indicate when a message has been stored for the split.

## Class of Restriction

Each ACD split and each individual agent is assigned a COR. You can use Miscellaneous Restrictions to prohibit selected users from accessing certain splits. You can use Miscellaneous Restrictions or restrictions assigned through the COR to prevent agents from being accessed individually. Unless you administer such restrictions, each agent can be accessed individually as well as through the split.

An agent with origination and termination restriction can receive ACD calls and use the assist function. A terminal in a COR with termination restriction can receive ACD calls.

If you are using Service Observing, administer a COR for observers and agents being observed.

## Trunk groups and ACD splits

- If you assign an ACD split extension as the incoming destination of a trunk group and that split's extension is later changed, you must also change the trunk group's incoming destination to a valid extension.
- Calls incoming on a non-DID trunk group can route to an ACD split instead of to an attendant. Calls incoming on any non-DID trunk group can have only one primary destination; therefore, the trunk group must be dedicated to the ACD split or a VDN.

- For MEGACOM 800 Service with DNIS over a wink/wink-tie trunk, if all agents are logged out or in AUX work mode, incoming MEGACOM calls receive a busy signal if no coverage path is provided (unlike other automatic-in trunk groups, which receive ringback from the central office).
- CO switches usually drop calls that remain unanswered after two to three minutes. Therefore, if an incoming CO call queues to a split without hearing an announcement or music, and the caller hears CO ringback for two to three minutes, the CO drops the call.

### Agent considerations

- Agents should not be used for hunt group calls and ACD split calls simultaneously. Otherwise, all calls from one split (either ACD or hunt group) are answered first. For example, if ACD calls are answered first, none of the hunt-group calls are answered until all of the ACD calls are answered.
- Agents with multiappearance voice terminals can receive only one ACD call at a time unless Multiple Call Handling is active. Without MCH, a voice terminal is available for an ACD call only if all call appearances are idle. The agent may, however, receive non-ACD calls while active on an ACD call.

### Vector-controlled splits

- You can enhance ACD by using Call Prompting, Call Vectoring and Expert Agent Selection. For detailed information on vector-controlled splits, see the *DEFINITY Enterprise Communications Server Call Vectoring/EAS Guide*. Vector-controlled splits/skills should not be called directly via the split/skill extension (instead of via a VDN mapped to a vector that terminates the call to a vector controlled split/skill). However, if split/skill extensions are called, the calls do not receive any announcements, are not forwarded or redirected to coverage, and do no intraflow/interflow to another hunt group.
- The oldest-call-waiting termination, which is available with Call Vectoring, is supported for agents who are servicing ACD calls only.

### Changing hunt groups from ACD to non-ACD

Before you change a hunt group from ACD to non-ACD, all agents in that hunt group must be logged out. When you change a hunt group from ACD to non-ACD, the system places all agents in that hunt group in busy state. If any voice terminals in the hunt group have an Auxiliary Work button, the button lamp lights. To become available for calls, the agent presses the Auxiliary Work button or dials the Hunt Group Busy Deactivation FAC followed by the hunt-group number.

## Interactions

---

- Attendant Call Waiting

An attendant can originate or extend a call to an ACD split. Attendant Call Waiting cannot be used on such calls. However, such calls can enter the split queue.

- Attendant Intrusion

Attendant Intrusion does not work with ACD split extensions because an ACD extension has many agent extensions. It is not possible to determine which agent extension to intrude upon.

- Automatic Callback

Automatic Callback calls cannot be activated toward an ACD split.

- Call Coverage

Calls can redirect to or from an ACD split. A vector-controlled split cannot be assigned a coverage path.

For a call to an ACD split to be redirected to call coverage on the Busy coverage criterion, one of the following conditions must exist:

- All agents in the split are active on at least one call appearance and the queue, if there is one, is full.
- No agents are logged in.
- All agents are in Auxiliary Work mode.

If the queue is not full, a call enters the queue when at least one agent is on an ACD call or in ACW mode. Queued calls remain in queue until the Coverage Don't Answer Interval expires before redirecting to coverage. If any split agent becomes available, the call is directed to the agent.

Calls that redirect on the Don't Answer coverage criterion are reported to BCMS/CMS as intraflowed calls.

If a call is queued for an ACD split and redirects via Call Coverage directly to an announcement, the call is dropped after the announcement.

Calls to a split that are directed to an agent's voice terminal do not follow the agent's call coverage path. If an agent activates Send All Calls it does not affect the distribution of ACD calls. An ACD split call directed to an agent's station follows the split's call coverage path, once the agent's Don't Answer interval is met.

- Call Forwarding All Calls

Call Forwarding All Calls activated for an individual extension does not affect the extension's ACD functions.

When activated for the split extension, calls directed to the split are forwarded from the split. Calls receive no announcements associated with that split (other than a forced first announcement, if administered). The

system reports to BCMS or CMS that calls are queued on the split. The system reports to CMS when the call is removed from the queue and forwarded.

Calls can be forwarded to an off-premises destination to activate Intraflow and Interflow. See [“Information Forwarding” on page 9-89](#) in this book for more information.

- Data Call Setup

Voice-terminal or data-terminal dialing can be used on calls to or from a member of an ACD split.

- Data Restriction

If the trunk group used for an ACD call has data restriction activated, agents with Automatic Answer activated do not hear the usual zip tone.

- DCS

CMS cannot measure ACD splits on a DCS network as if they were one switch. Agents for a split must be all on the same switch. If a call to an ACD split is forwarded to a split at another DCS node, the caller does not hear the forced first announcement at the second split.

If an ACD split is in night service, with a split at second DCS node as the night service destination, a call to the first split is connected to the second split's first forced announcement.

- Dial Intercom

An agent with origination and termination restriction can receive ACD calls and can make and receive dial intercom calls.

- Hold

If an agent puts an ACD call on hold, information is reported to the CMS via Personal Call Tracking. CMS records the amount of time the agent actually talks on the call.

- Individual Attendant Access

Individual attendant extensions can be assigned to ACD splits. Unlike voice-terminal users, individual attendants can answer ACD calls as long as there is an idle call appearance and no other ACD call is on the console.

- Internal Automatic Answer (IAA)

Internal calls directed to an ACD split are eligible for IAA. You cannot administer IAA and ACD Automatic Answer simultaneously on the same station.

- Intraflow and Interflow

Intraflow and Interflow, when used with Call Forwarding All Calls or Call Coverage, allows splits to be redirected to other destinations on and outside the system. For more information, see [“Information Forwarding” on page 9-89](#).

- Multiappearance Preselection and Preference

All assigned call appearances must be idle before an ACD call is directed to a voice terminal.
- Night Service – Hunt Group

When Hunt Group Night Service is activated for a split and the night-service destination is a hunt group, a caller hears the first forced announcement at the original split. The call is redirected to the night-service destination hunt group. If all agents in the hunt group are busy, the caller hears whatever you have assigned.
- Terminating Extension Group

A TEG cannot be a member of an ACD split.
- Transfer

Calls cannot be transferred to a busy split. The transfer fails and the agent transferring the call is re-connected to the call. If an agent presses the Transfer button, dials the hunt-group extension number, and then disconnects while the split is busy, the call is disconnected.
- Voice Terminal Display

For calls dialed directly to an ACD split extension, the identity of both the calling party and ACD split are shown on the voice terminal display.

## Basic Call Management System

---

Basic Call Management System (BCMS) provides real-time and historical reports to assist you in managing agents, ACD splits (hunt groups), VDNs, and trunk groups. You can display BCMS reports on the Management Terminal or print them on the printer associated with the Management Terminal. In addition, you can schedule historical reports to print on the system printer.

BCMS provides the following reports:

- Real Time Reports
  - Split Status
  - System Status
  - VDN Status
- Historical Reports
  - Agent
  - Agent Summary
  - Split
  - Split Summary
  - Trunk Group
  - Trunk Group Summary
  - VDN
  - VDN Summary

For a detailed description of BCMS and the reports it provides, see *DEFINITY Enterprise Communications Server Release 6 Basic Call Management System (BCMS) Operations*.

## How to administer BCMS

---

### Required forms

| Form                                  | Field  | Page                  |
|---------------------------------------|--|-----------------------|
| System Parameters<br>Customer-Options | ■ BCMS   | <a href="#">5-277</a> |
|                                       | ■ BCMS Service Level   |                       |
|                                       | ■ ACD  |                       |
|                                       | ■ BCMS/VuStats Login ID  |                       |
| Agent LoginID                         | ■ When BCMS is being used with EAS, complete all fields for each agent           | <a href="#">9-193</a> |
| BCMS/VuStats Login ID                 | ■ When BCMS is being used without EAS, enter a Login ID and Name for each agent. | <a href="#">9-200</a> |
| Feature-Related<br>System Parameters  | ■ BCMS Parameters  | <a href="#">5-123</a> |
|                                       | ■ BCMS/VuStats Measurement Interval  |                       |
|                                       | ■ ACD Login Identification Length  |                       |
|                                       | ■ BCMS/VuStats Abandoned Call Timer  |                       |
|                                       | ■ System Printer Extension   |                       |
|                                       | ■ Lines Per Page   |                       |
| Hunt Groups                           | ■ Measured   | <a href="#">5-158</a> |
|                                       | ■ Acceptable Service Level   |                       |
| Trunk Groups                          | ■ Measured   | <a href="#">7-115</a> |
| Vector Directory<br>Number (VDN)      | ■ Measured   | <a href="#">9-214</a> |
|                                       | ■ Acceptable Service Level   |                       |

All agents should log off before any changes are made to the BCMS/VuStats Login ID form.

Measurements can be turned off for a split while agents are logged in, but agents must be logged off to start measurements for a split.

**Interactions**

---

For information about how BCMS records redirected and conferenced calls, see *DEFINITY Enterprise Communications Server Basic Call Management System (BCMS) Operations*.

- **Move Agents From CMS**

If agents are moved from one split to another split by the CMS adjunct, measurements are stopped for the agent's "from" split and started for the agent's "to" split.

If the adjunct CMS attempts to move an agent that is not being measured by BCMS into a split that is being measured by BCMS, and the move would exceed the maximum number of measured agents, the switch rejects the move. Otherwise, internal BCMS measurements are started for the agent. If the adjunct CMS moves an agent from a split that is measured by BCMS to a split that is not BCMS-measured, internal measurements for the agent stop.

- **Night Service**

When night service is activated for a split, new calls go to the alternate destination. BCMS does not record these calls as OUTFLOW. If the destination is a measured split, BCMS treats the calls as new incoming calls (that is, BCMS does not record them as INFLOW).

- **System Measurements**

The system can produce BCMS reports, adjunct CMS reports, and switch traffic measurements simultaneously.

BCMS measurements are not determined in the same way as trunk group and hunt group measurements although some of the information is similar. Therefore, the two reports may represent data differently.

**Table 9-2. System Capacity**

|  | <b>R6vs/csi/si</b> | <b>R6r</b>       |
|--|--------------------|------------------|
| Maximum agents displays by Monitor BCMS Split command            | 100 <sup>1</sup>   | 100 <sup>1</sup> |
| Maximum BCMS terminals   | 3                  | 4                |
| Maximum active maintenance commands for system                   | 1                  | 5                |
| Maximum BCMS terminals in monitor mode at same time <sup>2</sup> | 1                  | 3                |



1. The Monitor Split command will only display status for the first 100 agents logged into the split regardless of how many additional agents log in to the split.



**9** Call Center  
*Basic Call Management System*

*Page 9-43*

2. BCMS monitoring, being a maintenance command, is limited by the active maintenance commands limit, reduced by 2 in the "r" system configuration (since 2 active command slots are reserved for the INADs and SAT logins respectively).
-

## Best Service Routing™

---

Best Service Routing™ (BSR) allows DEFINITY® ECS to compare specified splits or skills, identify the split or skill that will provide the best service to a call, and deliver the call to that resource. If no agents are currently available in that split or skill, the call is queued. To respond to changing conditions and operate more efficiently, BSR monitors the status of the specified resources and adjusts call processing and routing as appropriate.

BSR is available in single and multi-site versions. Single-site BSR compares splits or skills on the DEFINITY ECS where it resides to find the best resource to service a call. Multi-site BSR extends this capability across a network of DEFINITY switches, comparing local splits or skills, remote splits or skills, or both, and routing calls to the resource that will provide the best service.

Best Service Routing is summarized in this chapter. For complete information on how to get the most from BSR, see Chapter 9, “Best Service Routing” in the *DEFINITY® ECS Release 6 Call Vectoring/Expert Agent Selection (EAS)* manual.

### Benefits of Best Service Routing

---

Both single- and multi-site BSR intelligently compare specific resources to find the one that can best service a call. In addition, multi-site BSR allows you to integrate a network of call centers for better load balancing and optimal agent utilization. Depending on your specific application, BSR can yield a variety of other benefits as shown below.

**Table 9-3. Best Service Routing benefits**

---

| <b>You can benefit by...</b>   | <b>As a result of...</b>   |
|--------------------------------|--|
| Improved customer satisfaction | <ul style="list-style-type: none"><li>■ Lower average speed of answer (ASA), thus more calls handled<sup>1</sup></li><li>■ Greater probability that expert agents will be available for a specific call type (for centers with Expert Agent Selection)</li><li>■ Lower abandonment rate</li></ul> <p>By balancing the load between locations in a network, BSR reduces extremes in wait times between the locations.</p> |

---

*Continued on next page*

**Table 9-3. Best Service Routing benefits — Continued**

| You can benefit by...   | As a result of...  |
|---|--|
| Increased revenue   | <ul style="list-style-type: none"> <li>■ Lower average speed of answer (ASA), thus more calls handled</li> <li>■ Lower abandonment rate</li> <li>■ Lower network cost</li> <li>■ Greater probability that high-revenue generating agents will be available for a specific call type (for centers with Expert Agent Selection)</li> </ul>   |
| Improved productivity   | <ul style="list-style-type: none"> <li>■ Increased agent occupancy rates<br/>                     Improve your service without adding staff, or reduce staff while maintaining your current level of service.</li> <li>■ Faster delivery of interflowed calls<br/>                     Agents at one location in a network are less likely to sit idle while calls wait in queue at another location.</li> </ul> |
| Increased operating flexibility, easier staffing and scheduling | <ul style="list-style-type: none"> <li>■ Larger pool of agents available to take calls in a split or skill<br/>                     Spikes in call volume at a single call center can be distributed across all centers. Temporarily understaffed centers can be supported by the other centers in the network.</li> </ul>   |
| Improved service levels   | <ul style="list-style-type: none"> <li>■ Lower average speed of answer (ASA), thus more calls handled</li> </ul>   |
| Increased performance   | <ul style="list-style-type: none"> <li>■ Less messaging and processing required per call</li> </ul>  |
| Operating separate sites as an integrated “virtual call center” | <ul style="list-style-type: none"> <li>■ DEFINITY ECS’s ability to compare resources and queue a call to the best one</li> <li>■ DEFINITY ECS’s enhanced information forwarding capabilities</li> </ul>  |

1. A location’s ASA may be low because the location is underutilized and agents are frequently sitting idle. When BSR is implemented at such a location, ASA may rise because of the rise in incoming call volume.

## Before you Start

For single-site BSR applications, your switch must meet the requirements shown below (except for LAI). To use multi-site BSR applications, both the switches involved and the network connecting them must meet all the requirements described in this section.

### CAUTION:

*To ensure your network meets the requirements for BSR support presented below, contact your Account Executive about BSR network certification.*

## Switch requirements

Your switch has to meet *all* of the requirements shown below to support Best Service Routing. Check the settings shown below before you try to use BSR.

**Table 9-4. Requirements to use Best Service Routing**

| Form   | Page | Field                                | Must be set to...                |
|--|------|--------------------------------------|----------------------------------|
| Software Version                                   | 1    | Memory Resident                      | G3V6i.03 or<br>G3V6r.03          |
| System-Parameters<br>Customer-Options <sup>1</sup> | 1    | G3 Version                           | V6 or higher                     |
|  | 2    | ISDN-BRI Trunks?                     | Y                                |
|  |      | ISDN-PRI Trunks?                     | Y                                |
|  | 3    | Vectoring (G3V4<br>Advanced Routing) | Y                                |
|  |      | Vectoring (Best<br>Service Routing)  | Y                                |
| Lookahead Interflow<br>(LAI) <sup>2</sup>          |      | Y                                    |                                  |
| Feature-Related<br>System Parameters               | 8    | Adjunct CMS Release                  | R3V6 or higher,<br>or left blank |

1. ISDN connectivity is only necessary if you want to use multi-site BSR. One or both of these fields must be set to "Y." Multi-site BSR operates over both BRI and PRI trunks.
2. Lookahead Interflow is only necessary if you want to use multi-site BSR. For status poll and interflow calls used in multi-site BSR applications, set up trunks as you would for LAI. See [Chapter 9, "Look-Ahead Interflow"](#), for more information. Information Forwarding is not required for polling calls

 **NOTE:**

If you begin using BSR and then decide to turn it off, you will not be able to set Vectoring (Best Service Routing) to “N” until you remove all BSR commands from vectors.

## Network requirements

To support BSR, networks must meet both the criteria for LAI call control operation over switched networks (see [“Look-Ahead Interflow” on page 9-98](#)) and the following criteria:

- The network must support end-to-end transport of codeset 0 user data, either as a User-to-User Information Element (UUI IE) or by QSIG Manufacturer Specific Information (MSI IE), in the ISDN SETUP and DISCONNECT messages. (For more information, see [“Information Forwarding” on page 9-89](#).)

Private networks can be configured for either QSIG (transport via MSI packaged in a codeset 0 Facility IE) or non-QSIG (transport via a codeset 0 UUI IE). Currently, public networks do not support QSIG and user data can only be transported via the UUI IE when supported by the network. Future public network offerings may support QSIG, possibly by Virtual Private Network.

- DEFINITY ECS must support the ISDN country protocol.
- The network byte limit for user information contents (the user data portion) must be large enough to carry the data needed for the customer application.

 **NOTE:**

Some public network providers may require service activation and/or fees for user information transport.

- Response time for ISDN signaling should be fast enough that an entire consider series can execute within a single ring cycle.

Enhanced information forwarding has been tested with several major carriers. To find out if these capabilities work with your carrier, check with your account team for the most current information.

If testing has not been done to verify operation over the public networks involved with the preferred specific configuration, use of private ISDN trunking between the nodes should be assumed until successful testing has been completed.

## How to administer Best Service Routing

BSR administration varies, depending on whether your switch is configured for single- or multi-site BSR.

## Single-site BSR

### Required forms for administering single-site BSR

| Form                                  | Field  | Page                  |
|---------------------------------------|--|-----------------------|
| System Parameters<br>Customer-Options | ■ G3 Version   | <a href="#">5-277</a> |
|                                       | ■ Vectoring (G3V4 Advanced Routing)                      |                       |
|                                       | ■ Vectoring (Best Service Routing)                       |                       |
| Feature-Related<br>System Parameters  | ■ Adjunct CMS Release                                    | <a href="#">5-123</a> |
| VDN                                   | ■ BSR Available Agent Strategy                           | <a href="#">9-214</a> |
| Call Vector                           | ■ Complete a form for each vector that uses BSR commands | <a href="#">9-207</a> |

## Multi-site BSR

### Required forms for administering multi-site BSR

| Form                                     | Field   | Page                  |
|--|---|-----------------------|
| System Parameters<br>Customer-Options    | ■ G3 Version  | <a href="#">5-277</a> |
|  | ■ Vectoring (Best Service Routing)  |                       |
|  | ■ Vectoring (G3V4 Advanced Routing)   |                       |
|  | ■ Lookahead Interflow (LAI)   |                       |
| Feature-Related<br>System Parameters     | ■ Adjunct CMS Release   | <a href="#">5-123</a> |
| Trunk Group<br>(ISDN-BRI) <sup>1</sup>   | ■ Outgoing Display  | <a href="#">7-198</a> |
|  | ■ Supplementary Service Protocol  |                       |
|  | ■ UII Treatment   |                       |
| Trunk Group<br>(ISDN-PRI)                | ■ Outgoing Display  | <a href="#">7-219</a> |
|  | ■ Supplementary Service Protocol  |                       |
|  | ■ UII Treatment   |                       |
| Best Service Routing<br>Application Plan | ■ Complete one form for each BSR application  | <a href="#">9-197</a> |
| VDN                                      | ■ BSR Application   | <a href="#">9-214</a> |
|  | ■ BSR Available Agent Strategy  |                       |
| Call Vector                              | ■ Complete a form for each vector (primary, status poll and interflow vectors) in a BSR application | <a href="#">9-207</a> |

- 
1. Settings in the fields Codeset to Send TCM, Lookahead and Send Codeset 6/7 LAI IE? on the ISDN trunk forms do not affect BSR.

Multi-site BSR requires that Look-Ahead Interflow (LAI) be enabled. See [“How to administer Look-Ahead Interflow” on page 9-99](#) for a list of required forms and fields. Since BSR can forward information such as VDN name, in-VDN time, and collected digits with interflowed calls, also see [“Administering User-to-User Information Transport” on page 9-90](#) for instructions.

## Detailed description

---

To use Best Service Routing on a single switch, you simply use special commands and command elements that are part of the DEFINITY ECS call vectoring language. As a result, BSR for a single location can be easily added to existing vectors without modifying other parts of DEFINITY ECS.

Multi-site applications work similarly, but additional administration is required. Since steps in a multi-site BSR vector will contact one or more remote locations, you need to define these locations, tell DEFINITY ECS how to contact each one, and set up VDNs and vectors to handle communications between the sending switch and each remote switch.

Three VDN/vector pairs must be used in every multi-site BSR application. The Primary VDN/vector pair, on the sending switch, contacts the specified remote switches, collects information, compares the information, and delivers or queues the call to the resource that is likely to provide the best service. Two VDN/vector pairs are needed on each remote switch. A Status Poll VDN/vector pair provides information about the best resource at its location in response to inquiries from BSR applications on other switches. Finally, an Interflow VDN/vector pair is needed to receive and process the calls interflowed from BSR applications on other switches.

## Call surplus situations

Every BSR application compares a set of predetermined resources (splits or skills) and selects the “best” resource to service the call. In a call surplus situation (no agents available), the best resource is the split or skill with the lowest Expected Wait Time (EWT). For purposes of calculating the best resource in a call surplus situation, BSR allows you to adjust the EWT figure for any split or skill. The actual EWT for calls in queue isn't changed, of course; only the figure used in the calculations performed by the BSR feature is changed. You don't have to enter adjustments, but the ability to adjust the EWT for splits or skills allows you to program preferences in vectors. Because of agent expertise, for example, or the availability or cost of tie trunks, you might prefer that some resources *not* service a call unless doing so significantly decreases the call's time in queue.

## Agent surplus situations

In an agent surplus situation (one or more agents available to take incoming calls), BSR will deliver a new call according to the BSR Available Agent Strategy specified on the VDN form. The “best” resource will be the split or skill that meets the criteria defined by the strategy you’ve chosen for that VDN. BSR can use any of the five strategies shown in the table below to select an agent when agents are available.

**Table 9-5. BSR Available Agent Strategies**

| If BSR Available Agent Strategy is set to... | The call will be delivered to...   |
|--|--|
| 1st-found                                    | the first available agent. BSR will not consider any other resources as soon as it finds an available agent.   |
| ucd-mia                                      | the agent who has been idle the longest. BSR will compare all the splits or skills specified in the vector before delivering the call.   |
| ead-mia                                      | the agent with the highest skill level relevant to the call who has been idle the longest. BSR will compare all the splits or skills specified in the vector before delivering the call. |
| ucd-loa                                      | the least-occupied agent. <sup>1</sup> BSR will compare all the splits or skills specified in the vector before delivering the call.   |
| ead-loa                                      | the agent with the highest skill level relevant to the call who is the least occupied. BSR will compare all the splits or skills specified in the vector before delivering the call.     |

1. LOA is a new agent selection method available as an option on DEFINITY ECS R6.3 and later switches. For more information, please see the *CentreVu® Advocate User Guide* (585-215-855).

When agents are available in one or more of the specified resources, BSR does not consider EWT adjustments in selecting an agent for a call.

**⇒ NOTE:**

The BSR Available Agent Strategy assigned to a VDN should match the agent selection method used in the splits or skills considered by a BSR application.



## Vector commands for single-site BSR

The following table shows the vector commands and command elements used in single-site BSR applications.

**Table 9-6. Vector commands and command elements for single-site BSR**

| Commands and command elements |                             | Use this ...  |
|-------------------------------|-----------------------------|---|
| Commands                      | <i>consider split/skill</i> | to obtain the Expected Wait Time or agent data needed to identify the best local resource. One <i>consider</i> step must be written for each split or skill you want to check. <sup>1</sup> |
|                               | <i>queue-to</i>             | with the <i>best</i> keyword to queue calls to the best resource identified by the <i>consider</i> sequence.  |
|                               | <i>check</i>                | with the <i>best</i> keyword to queue calls to the best resource identified by the <i>consider</i> sequence if the resource meets certain conditions.                                       |

*Continued on next page*

Table 9-6. Vector commands and command elements  
 for single-site BSR — *Continued*

| Commands and command elements |                      | Use this ...  |
|-------------------------------|----------------------|---|
| Key word                      | <i>best</i>          | in <i>queue-to</i> , <i>check</i> , and <i>goto</i> commands that refer to the resource identified as best by a series of consider steps  |
| Conditional                   | <i>wait-improved</i> | to prevent calls from being queued to an additional split or skill when the reduction in Expected Wait Time isn't enough to be useful. "Wait improved" means that a call's EWT must be improved by a specific amount (a figure you specify in seconds) over its current EWT or DEFINITY ECS won't queue it to the additional split or skill.  |
| User adjustment               | <i>adjust-by</i>     | to specify your preferences for the splits or skills that might handle calls in a particular vector. Any time a <i>consider</i> step returns EWT for a local split or skill, you can increase this value. <sup>2</sup> As a result, this split or skill is less likely to service a call unless its EWT is significantly shorter than that of any other available split or skill.<br><br>For example, you may prefer that the main split or skill in a vector handle as many calls as possible but want to use another split or skill as a backup. You can write the <i>consider</i> step that checks the backup split or skill to increase the returned EWT by a set amount. |



1. Since the *consider* command is designed to compare two or more resources, *consider* commands are typically written in sequences of two or more with the sequence terminating in a *queue-to best* step. This set of *consider* commands and a *queue-to best* step is called a consider series.
2. Of course, DEFINITY ECS doesn't increase the actual wait time in a split or skill. It only adjusts EWT in the calculations used to identify the "best" split or skill to which to queue a call.

## Vector commands for multi-site BSR

The following table summarizes the vector commands and command elements that support multi-site BSR applications.

**Table 9-7. Vector commands and command elements for multi-site BSR**

| Commands and command elements |                             | Use this...   |
|-------------------------------|-----------------------------|---|
| Commands                      | <i>consider split/skill</i> | to obtain the Expected Wait Time or agent data needed to identify the best local resource. One <i>consider</i> step must be written for each split or skill you want to check. <sup>1</sup>   |
|                               | <i>consider location</i>    | to obtain the Expected Wait Time or agent data needed to identify the best resource at a remote switch. One <i>consider</i> step must be written for each location you want to check. Routing information is obtained from the BSR Application plan for the active VDN. |
|                               | <i>reply-best</i>           | to return data to another switch in response to a status poll   |
|                               | <i>queue-to</i>             | with the <i>best</i> keyword to queue calls to the best resource identified by the <i>consider</i> sequence.  |
|                               | <i>check</i>                | with the <i>best</i> keyword to queue calls to the best resource identified by the <i>consider</i> sequence if the resource meets certain conditions.   |

*Continued on next page*

Table 9-7. Vector commands and command elements  
 for multi-site BSR — *Continued*

| Commands and command elements |                      | Use this...  |
|-------------------------------|----------------------|--|
| Key word                      | <i>best</i>          | in <i>queue-to</i> , <i>check</i> , and <i>goto</i> commands that refer to the resource identified as best by a series of <i>consider</i> steps  |
| Conditional                   | <i>wait-improved</i> | to prevent calls from being queued to an additional split or skill—local or remote—when the reduction in Expected Wait Time isn't enough to be useful. "Wait improved" means that a call's EWT must be improved by a specific amount (a figure you specify in seconds) over its current EWT or DEFINITY ECS won't queue it to the additional split or skill. |
| User adjustment               | <i>adjust-by</i>     | control long-distance costs and limit trunk usage. Any time a vector polls a local or remote resource, you can increase the EWT returned by that resource by a preset amount. <sup>2</sup> You might want to set this adjustment to reflect factors such as the availability of tie trunks or agent expertise at remote locations.                           |



1. Since the *consider* command is designed to compare two or more resources, *consider* commands are typically written in sequences of two or more with the sequence terminating in a *queue-to best* step. This set of *consider* commands and a *queue-to best* step is called a *consider* series.
2. Of course, DEFINITY ECS doesn't increase the actual wait time in a split or skill. It only adjusts EWT in the calculations used to identify the "best" split or skill to which to queue a call.

## Interactions

---

- Agent Terminal Display  
If collected digits are forwarded with an interflowed call, the forwarded digits are displayed to the answering agent (unless they're overridden with newly collected digits).
- Best Service Routing (BSR)/LAI

Restrictions and interactions that apply to LAI also apply to BSR status poll and interflow calls. See the *DEFINITY® ECS Release 6 Call Vectoring/Expert Agent Selection (EAS) Guide* (555-230-521) or the [“Look-Ahead Interflow”](#) chapter in this manual for more information.

- BCMS

BCMS does not report accumulated in-VDN time.

BCMS does not log LAI attempts and therefore will not log BSR status polls, which are treated as LAI attempts.

- Call Vectoring

The following considerations apply to ALL vectors when BSR is enabled on your switch.

**route-to VDN:** If a call is routed to a new VDN, any “best” resource data defined by a series of consider steps in the previous VDN will be initialized (cleared)

**goto vector:** If a *goto vector* command is executed, any “best” resource data produced by a series of consider steps in the original VDN will remain with the call and can be used in the subsequent vector.

**best keyword:** The *best* keyword cannot be used as a replacement for split/skill in the following vector commands:

- *converse-on split/skill*
- *messaging split/skill*

The *best* keyword can be used in the following commands, but only with the conditionals listed:

- *goto step* or *goto vector* commands using the *expected-wait* or *wait-improved* conditionals
- *check* commands using the *unconditional*, *expected-wait*, or *wait-improved* conditionals

**Consider command:** Don't use other commands within a series of *consider* steps, since these may delay the execution of the series.

Splits or skills used in *consider* commands must be vector controlled.

**Converse command:** Collected digits forwarded with the call will be passed to VRU via the "digits" data passing type.

- Direct Department Calling

BSR will function when the considered splits use DDC call distribution. Once the best resource is determined, the actual call distribution will follow the split's DDC setting regardless of the BSR Available Agent Strategy. DDC may not be used as a BSR Available Agent Strategy.
- Expert Agent Selection

EAS is required to use the EAD-MIA or EAD-LOA Available Agent Strategy. EAS VDN skills (1st, 2nd, 3rd) can be used in *consider skill* commands.
- Facility Restriction Levels

The FRL applies to status poll and interflow calls in the same way it works with the "route-to number" command.
- ISDN

Best Service Routing and globally supported information transport are fully functional over ISDN PRI or ISDN BRI trunking facilities.
- Lucent Distributed Networking via QSIG - Manufacturers Specific Information (MSI)

BSR will not function with systems from other vendors (unless that vendor develops a corresponding capability that works with DEFINITY ECS).
- Multi-Split/Skill Queuing

A call may be queued up to 3 times by *queue-to* or *check* commands in the same vector. One vector may therefore contain up to 3 series of *consider* steps. Each series must be followed by a *queue-to best* step. Each consider series will select the best remote resource from the options you specify and queue the call to that resource.
- Network Access

BSR operates over public, private, or virtual private (for example, SDN) ISDN-BRI and -PRI networks that meet the criteria explained in ["Network requirements" on page 9-47](#). Best Service Routing requires that the network support transport of user-to-user data via MSI or UUI as a codeset 0 Information Element. The numbers administered on the BSR Application Plan form are expected to access VDNs via ISDN trunks.

Administration or call processing will not prevent access to other types of routing numbers, but BSR is only intended to support the types of applications described in this section. Attempts to use the BSR feature for any other purposes may not work.
- Operating Support System Interface (OSSI)

The new administration commands, conditionals, keywords and forms are available via OSSI.

- QSIG

LAI, BSR, and information forwarding function over QSIG trunk facilities if the remote locations are DEFINITY systems. BSR and information forwarding require R3V6.3 or later switch software.
- Redirection on No Answer (RONA)

Calls redirected to a VDN by RONA can be subsequently processed and BSR or LAI applications. When the RONA feature redirects a call to a VDN, any best resource data defined in a previous vector will be initialized (cleared).
- Service Observing

You can observe a call in BSR or LAI processing as long as the call is still connected through the local DEFINITY ECS. All current restrictions on Service Observing still apply.
- Transfer

If a call is transferred to a VDN, any best resource data defined in previous vector processing will be initialized (cleared). In fact, transferred calls do not forward any of the information that is forwarded with interflows (previously collected digits, In-VDN time, etc.).
- Trunk Access Code (TAC)

Use of routing numbers (status poll or interflow) that utilize TACs is not recommended since the required in-band outpulsing slows the setup operation significantly.
- VDN Override

VDN Override applies to the BSR Application Number and the Available Agent Strategy option assigned on the VDN form. It also applies to the VDN name forwarded via Information Forwarding. When a *consider* step is executed, the application number and available agent strategy assigned to the active VDN for the call will be used.
- VDN Return Destination

The best resource data for a call is initialized when the call first leaves vector processing and therefore will not be available should the call return to vector processing.
- VuStats

No enhancements have been added for BSR.

## Call Management System

Call Management System (CMS) allows you to collect and monitor ACD facilities and personnel. You can create reports on the status of agents, splits, trunks, vectors, and vector directory numbers. You can store historical CMS reports or display real-time reports at a terminal.

Unlike Basic Call Management System (BCMS), the CMS resides on an adjunct computer that connects to the switch via a data link. See [Figure 9-1](#) for a typical ACD CMS configuration.

This section describes how to administer the interface between DEFINITY and CMS. See *CentreVu Call Management System Release 3 Version 5 Administration* for more information on CMS.

### How to administer the DEFINITY/CMS Interface

#### Required forms

| Form   | Field                              | Page                  |
|--|------------------------------------|-----------------------|
| Feature-Related System Parameters                                    | ■ Adjunct CMS Release              | <a href="#">5-123</a> |
|  | ■ Automatic Call Distribution      |                       |
|  | ■ ACD Log-in Identification Length |                       |
|  | ■ Minimum Agent Login ID           |                       |
|  | ■ Password Length                  |                       |
| Processor Interface Data Module (R5si and later configurations only) | ■ All (for one CMS link)           | <a href="#">6-246</a> |
| Processor/Trunk Data Module (PDM)                                    | ■ All (for one CMS link)           | <a href="#">6-243</a> |
| X.25 Data Module (R5r and later configurations only)                 | ■ All (for one CMS link)           | <a href="#">6-249</a> |
| Processor Channel Assignment   | ■ All (for one CMS link)           | <a href="#">5-248</a> |
| Interface Links  | ■ All (for one CMS link)           | <a href="#">5-179</a> |
| Hunt Group   | ■ Measured                         | <a href="#">5-158</a> |
| Trunk Group (All)  | ■ Measured                         | <a href="#">7-115</a> |
| Vector Directory Number (VDN)  | ■ Measured                         | <a href="#">9-214</a> |
| Packet Gateway Board (PGATE) (R5r and later configurations only)     | ■ All                              | <a href="#">5-246</a> |



- Feature-Related System Parameters form — In ACD Log-in Identification Length, enter the number of digits the agent must dial to log into the ACD split. Enter the appropriate Adjunct CMS Release number.
- Processor Interface Data Module form — Assign a physical channel and maintenance extension. For the PDM data module, assign a digital line port. For the X.25 data module, assign DTE/DCE as **dte** and Baud Rate as **9600**.
- Processor Channel Assignment form — Enter the CMS link number from the Interface Links Form. Enter the appropriate Interface Channel and Remote Proc Chan. Leave the Machine ID field blank.
- Communication Interface Link form — Enter in Destination Digits the extension assigned to the PDM data module. Set the Prot field **bx25**. Set the DTE/DCE field to **dte**.
- Complete the form that applies (Hunt Group, Trunk Group, and VDN Forms) when the Measured field is set to either external or both. See the *DEFINITY Enterprise Communications Server Release 6 System Description Pocket Reference* for the maximum number of hunt groups, trunk groups, agents, and VDNs that can be measured.
- Packet Gateway (PGATE) form — Enter the board location.

## Considerations

---

CMS measurements may be inaccurate on calls to splits that intraflow to the attendant group.

## Interactions

---

None.

## Call Prompting

---

See the *DEFINITY Enterprise Communications Server Release 6 Call Vectoring/EAS Guide* for a detailed description of Call Prompting and its uses. The guide contains information that is critical to the effective and efficient use of this feature.

Call Prompting uses specialized vector commands to process incoming calls based on information collected from the caller or from an ISDN-PRI message. It can be used in various applications to better handle incoming calls. The following list gives a brief description of some Call Prompting applications.

- Automated Attendant — Allows the caller to enter the extension of the party that he or she would like to reach. The call is routed to that extension.
- Data In/Voice Answer (DIVA) Capability — Allows the caller to hear an announcement based on the digits that he or she enters, or to be directed to a hunt group or another system extension.
- Data Collection — Allows the caller to enter data that can be used by a host/adjunct to assist in call handling. This data, for example, may be the caller's account number.
- CINFO (Caller Information Forwarding) Routing — Allows a call to be routed based on digits supplied by the network in an ISDN-PRI message.
- Message Collection — Gives the caller the option of leaving a message or waiting in queue for an agent.

## How to administer Call Prompting

---

### Required forms

| Form                                  | Field  | Page                  |
|---------------------------------------|--|-----------------------|
| System Parameters<br>Customer-Options | ■ Vectoring (Prompting)  | <a href="#">5-277</a> |
|                                       | ■ Vectoring (CINFO)  |                       |
|                                       | ■ ISDN-PRI — for CINFO only  |                       |
|                                       | ■ This form describes other vectoring options that may be required depending upon the application. |                       |
| Feature-Related System<br>Parameters  | ■ Prompting Timeout  | <a href="#">5-123</a> |
| Vector Directory Number               | ■ All  | <a href="#">9-214</a> |

*Continued on next page*

**Required forms**

| Form                        | Field  | Page                  |
|-----------------------------|--|-----------------------|
| Announcements/Audio Sources | ■ Complete all fields for each extension that provides a Call Prompting announcement | <a href="#">5-26</a>  |
| Hunt Group                  | ■ Vector   | <a href="#">5-158</a> |
| Call Vector                 | ■ Complete a form for each Call Prompting vector                                     | <a href="#">9-207</a> |
| Station (multi-appearance)  | ■ Button/Feature Button Assignments - callr-info                                     | <a href="#">6-14</a>  |
| Attendant Console           | ■ Feature Button Assignments -callr-info   | <a href="#">5-35</a>  |

If Vectoring (Basic) is not enabled on the System-Parameters Customer-Options form, the Call Prompting feature cannot queue calls or make conditional checks based on queue or agent status, time of day, or day of week.

CINFO requires the AT&T Intelligent Call Processing (ICP) service, ISDN-PRI, and Vectoring (Prompting).

You can administer any display-equipped voice terminal or attendant console with a Caller Information CALLR-INFO button. The button displays digits collected for the last *collect digits* command.

You must have Call Vectoring software for CMS to use Call Prompting (with or without Call Vectoring) with CMS.

**Considerations**

Call prompting, with the exception of CINFO, competes with several features for ports on the call classifier - detector circuit pack or equivalent.

**Interactions**

The following interactions apply specifically to Call Prompting. For general Call Vectoring interactions that may affect Call Prompting applications see [“Call Vectoring” on page 9-63](#).

- Authorization Codes

If authorization codes are enabled, and a *route-to* command in a prompting vector accesses AAR or ARS, if the VDN's FRL does not have the permission to use the chosen routing preference, then the system does not prompt for an authorization code and the *route-to* command fails.

- CallVisor ASAI

ASAI-provided digits can be collected by the Call Vectoring feature via the *collect* vector command as dial-ahead digits. CINFO is passed to CallVisor ASAI.

- Hold

With the exception of CINFO, if a call is put on hold during the processing of a *collect* command, the command restarts, beginning with the announcement prompt, when the call is taken off hold. All dialed-ahead digits are lost. Similarly, if a call to a vector is put on hold, vector processing is suspended when a *collect* command is encountered. When the call becomes active, the *collect* command resumes.

- Inbound Call Management (ICM)

You can use Call Prompting to collect information that may later be used by an adjunct to handle a call.

- Transfer

If a call to a VDN is transferred during a *collect* command, the *collect* command restarts when the transfer is complete, and all dialed-ahead digits are lost. Similarly, if a call to a vector is transferred, vector processing is suspended when a *collect* command is encountered. When the transfer is complete, the *collect* command resumes. This is not true when a *collect* command collects CINFO digits. In this case vector processing is not suspended. Attendant extended calls do suspend vector processing in the same way as transferred calls.

## Call Vectoring

---

Call Vectoring processes incoming and internal calls according to a programmed set of commands. These commands, called vector commands, determine the type of processing that calls receive. For example, vector commands can direct calls to on-premise or off-premise destinations, to any hunt group, split, or skill, or to a specific call treatment such as an announcement, forced disconnect, forced busy, or delay. Vectors can queue or route calls based on a variety of different conditions.

There are many different applications for Call Vectoring. However, it primarily is used to handle the call activity of ACD splits/skills.

For more information about administering call vectoring, see [“Best Service Routing™” on page 9-44](#) and [“Look-Ahead Interflow” on page 9-98](#).

See the *DEFINITY Enterprise Communications Server Call Vectoring/EAS Guide* for a detailed description of Call Vectoring and its uses. The guide contains information that is critical to the effective and efficient use of this feature.

## How to administer Call Vectoring

---

### Required forms

| Form                                  | Field   | Page                  |
|---------------------------------------|---|-----------------------|
| System Parameters<br>Customer-Options | ■ Vectoring (Basic)   | <a href="#">5-277</a> |
|                                       | ■ Vectoring (G3V4 Enhanced)   |                       |
|                                       | ■ Vectoring (G3V4 Advanced Routing)   |                       |
|                                       | ■ Vectoring (ANI/II-Digits Routing)   |                       |
| Vector Directory Number               | ■ All   | <a href="#">9-214</a> |
| Announcements/Audio<br>Sources        | ■ Complete all fields for each extension that provides a vectoring announcement | <a href="#">5-26</a>  |
| Hunt Group                            | ■ Vector  | <a href="#">5-158</a> |
|                                       | ■ ACD   |                       |

**Required forms**

| Form                              | Field  | Page                  |
|-----------------------------------|--|-----------------------|
| Call Vector                       | <ul style="list-style-type: none"> <li>■ Complete a form for each vector</li> </ul>  | <a href="#">9-207</a> |
| Feature-Related System Parameters | <ul style="list-style-type: none"> <li>■ Vector Disconnect Timer</li> <li>■ Music/Tone on Hold</li> <li>■ Port</li> <li>■ Music (or Silence) on Transferred Trunk Calls</li> </ul> | <a href="#">5-123</a> |
| Vector Routing Table              | <ul style="list-style-type: none"> <li>■ All</li> </ul>  | <a href="#">9-219</a> |

Do not change a vector while it is processing calls since calls already in the vector could experience problems. Instead, add a new vector and change the VDN to point to the new vector.

You cannot enter a VDN extension in the fields listed in [Table 9-8](#).

**Table 9-8. VDN extension cannot be entered in these fields.**

| Form                        | Field  |
|-----------------------------|--|
| Announcements/Audio Sources | <ul style="list-style-type: none"> <li>■ Extension Number</li> </ul>   |
| Call Coverage Answer Group  | <ul style="list-style-type: none"> <li>■ Group Member Assignments</li> </ul>                                       |
| Call Coverage Paths         | <ul style="list-style-type: none"> <li>■ Coverage Point Assignments, other than the last coverage point</li> </ul> |
| Console Parameters          | <ul style="list-style-type: none"> <li>■ CAS Back-up Extension</li> </ul>  |

*Continued on next page*

**Table 9-8. VDN extension cannot be entered in these fields. — *Continued***

| Form                                       | Field   |
|--|---|
| Feature-Related System Parameters          | <ul style="list-style-type: none"> <li>■ ACA Long Holding Time Originating Extension</li> <li>■ ACA Short Holding Time Originating Extension</li> <li>■ Extensions With System wide Retrieval Permission</li> <li>■ Controlled Outward Restriction Intercept Treatment</li> <li>■ Controlled Termination Restriction (Do Not Disturb)</li> <li>■ Controlled Station-to-Station Restriction</li> </ul> |
| Hospitality                                | <ul style="list-style-type: none"> <li>■ Extension of PMS Log Printer</li> <li>■ Extension of Journal/Schedule Printer</li> <li>■ Extension of PMS</li> <li>■ Extension to Receive Failed Wakeup LWC Messages</li> </ul>  |
| Hunt Group and Agent LoginID with EAS      | <ul style="list-style-type: none"> <li>■ Supervisor Extension</li> <li>■ Member Extensions</li> </ul>   |
| Intercom Group                             | <ul style="list-style-type: none"> <li>■ Member Extensions</li> </ul>   |
| Listed Directory Numbers                   | <ul style="list-style-type: none"> <li>■ LDN Extensions</li> </ul>  |
| Loudspeaker Paging and Code Calling Access | <ul style="list-style-type: none"> <li>■ Extension Numbers Assigned to Codes</li> </ul>   |
| Pickup Groups                              | <ul style="list-style-type: none"> <li>■ Member Extensions</li> </ul>   |
| Remote Access                              | <ul style="list-style-type: none"> <li>■ Remote Access Extension</li> </ul>   |
| Station Forms                              | <ul style="list-style-type: none"> <li>■ Hunt to Station</li> </ul>   |
| Terminating Extension Group                | <ul style="list-style-type: none"> <li>■ Member Extensions</li> </ul>   |

You can enter a VDN extension in the following fields.

| Form                      | Field   |
|---------------------------|---|
| Abbreviated Dialing Lists |   |
| Call Coverage Paths       | <ul style="list-style-type: none"> <li>■ allow it as the last coverage point only</li> </ul>          |
| Hunt Group                | <ul style="list-style-type: none"> <li>■ Night Destination</li> </ul>                                 |
| Listed Directory Numbers  | <ul style="list-style-type: none"> <li>■ Night Destination</li> </ul>                                 |
| Trunk Groups              | <ul style="list-style-type: none"> <li>■ Night Destination</li> <li>■ Incoming Destination</li> </ul> |

You cannot enter a VDN extension as auxiliary data for the following buttons:

- Bridged Appearance (brdg-app)
- Data Call Setup (data-ext)

You can enter a VDN extension as auxiliary data for the following buttons:

- Remote Message Waiting Indicator (aut-msg-wt)
- Facility Busy Indication (busy-ind)
- Manual Message Waiting (man-msg-wt)
- Manual Signaling (signal)

## Interactions

---

- AP Demand Print
 

A VDN cannot be used as an argument to the feature access code for AP Demand Print.
- Attendant Control of Trunk Group Access
 

If a *route-to* step in a vector dials a controlled trunk group, vector processing continues at the next step.
- Attendant Recall
 

Attendant Recall to a VDN is blocked.
- AUDIX Interface
 

A *route-to* step in a vector may call the AUDIX extension. If a voice port can be seized to that adjunct, vector processing is terminated. The system sends a message to AUDIX requesting retrieval of messages for the originating extension (not the VDN).

AUDIX may also be accessed by the *queue-to main split* and *check-backup split* commands. Also, the messaging step may use an AUDIX hunt group in its operation.



- Authorization Codes

If authorization codes are enabled, and if a *route-to* command in a prompting vector accesses AAR or ARS and the VDN's FRL does not have the permission to utilize the chosen routing preference, then no authorization code is prompted for and the *route-to* command fails.
- Automatic Alternate Routing (AAR)/Automatic Route Selection (ARS)

Any *route-to* command in a vector can dial an AAR/ARS FAC followed by other digits. It cannot dial only the FAC.
- Automatic Callback

Automatic Callback cannot be used for calls placed to a VDN.
- Bridged Call Appearance

VDN extensions cannot be assigned to bridged appearance buttons. A *route-to* command to an extension with bridged appearances updates bridged appearance button lamps.
- Busy Verification of Terminals and Trunks

Busy verification of VDNs is denied and intercept tone is returned.
- Call Coverage

A VDN may be administered as the last point in a coverage path.
- Call Forwarding

Calls can be forwarded to a VDN. Calls placed by a *route-to* command to an extension that has call forwarding activated are forwarded.

An attendant or voice terminal with console permission cannot activation/deactivation call forwarding for a VDN.

An attendant or voice terminal with console permission cannot activation/deactivation call forwarding for a vector-controlled hunt group.
- Call Detail Recording

You can administer the Feature Related System Parameters form so that the VDN extension is used in place of the Hunt Group or Agent extension. This overrides the "Call to Hunt Group - Record" option of CDR for Call Vectoring calls.

If a vector interacts with an extension or group that has Call Forwarding All Calls active, normal Call Forwarding/CDR interactions apply.

For incoming calls to a VDN, the duration of the call is recorded from the time answer supervision is returned.

  - If answer supervision is returned by the vector, and the call never goes to another extension, then the VDN extension is recorded as the called number in the CDR record.

- If the call terminates to a hunt group, then the VDN, hunt group, or agent extension is recorded as the called number as per the administration described above.
- If the call terminates to a trunk, then the following two CDR records are generated:
  - An incoming record with the VDN as the called number and the duration from the time answer supervision was provided to the incoming trunk.
  - An outgoing record containing the incoming trunk information as the calling number and the dialed digits and the outgoing trunk information as the called number.

Outgoing vector calls generate ordinary outgoing CDR records with the originating extension as the calling number.

No Ineffective Call Attempt records are generated for Call Vectoring *route-to* commands that are unsuccessful.

- Call Detail Recording — Account Code Dialing

If a *route-to number* command in a vector specifies an CDR account code, vector processing continues at the next step.

- Call Park

Calls cannot be parked on a VDN.

- Call Waiting Termination

If an extension is busy and has call waiting termination administered, the *route-to with cov n* operation is considered unsuccessful and vector processing continues at the next step. *Route-to with cov y* is successful (call will wait) and vector processing terminates.

- Class of Restriction

Each VDN in the system has a COR associated with it. This VDN COR is used to determine the calling permissions/restrictions, the AAR/ARS PGN, and the priority queuing associated with a vector.

- Code Calling Access

A VDN cannot be used as the argument to the code calling access feature access code.

If a *route-to number* command in a vector specifies the code calling feature access code, vector processing continues at the next step.

- Conference

A call to a VDN can be included as a party in a conference call only after vector processing terminates for that call.

- Data Restriction

Music will play on calls from data restricted extensions when the call receives music as the result of a wait-time vector step.

- Facilities Restriction Level

If a *route-to* command dials an external number via AAR/ARS, the FRL associated with the VDN COR is used to determine the accessibility of a routing preference in an AAR/ARS pattern.
- Facility Busy Indication

The facility busy lamp indication for a VDN is always off. A facility busy button may be used to call a VDN.
- Facility Test Calls

If a *route-to number* command in a vector specifies a Facility Test Call, vector processing continues at the next step.
- Forced Entry of Account Codes

If a COR requiring entry of account codes is assigned to a VDN, the *route-to number* commands executed by the associated vector are unsuccessful and vector processing continues at the next step.
- Individual Attendant Access

A call sent to an attendant by a *route-to number* command can wait in the attendant priority queue. The call is removed from vector processing.
- Integrated Directory

VDN names and extensions are not available in the Integrated Directory feature.
- Intercept Treatment

A VDN cannot be used for Intercept Treatment.
- Inter-PBX Attendant Calls

A *route-to number* command in a vector can dial the Inter-PBX Attendant. If the call attempts to access a controlled trunk group, vector processing continues at the next step.
- Intraflow and Interflow

The functionality of intraflow and interflow may be obtained using the *check-backup split* and *goto* Call Vectoring commands.

Calls may intraflow from an ACD split which is not vector-controlled into one that is vector-controlled.
- Leave Word Calling

LWC messages cannot be stored, canceled, or retrieved for a VDN.
- Night Service

A VDN can be administered as a night service destination.

*Route-to* commands that route to destinations with night service activated redirect to the night service destinations.
- Priority Calling

A VDN cannot be used with the priority calling access code. Intercept tone is supplied to the user. If a *route-to number* in a vector specifies the priority calling access code, vector processing continues at the next step.

- Property Management System Interface

VDNs cannot be used with the following features and functions: Message Waiting Notification, Check-In, Check-Out, Room Status, and Automatic Wakeup.

- Recorded Announcement

The first announcement extension, second announcement extension, first announcement delay, second announcement delay, and recurring second announcement do not exist for a vector-controlled hunt group.

- Redirection on No Answer

If an ACD split/skill or Direct Agent call is not answered after an administered number of rings, RONA can redirect that call to a VDN for alternate treatment.

- Ringback Queuing

External call attempts made via *route-to* commands with coverage no are not queue via Ringback Queuing when all trunks are busy. External call attempts made via *route-to* commands with coverage yes are.

- Send All Calls

If the destination of a *route-to with coverage no* command has the Send All Calls feature active, calls are not redirected. If there is an idle appearance, the call terminates and vector processing stops. If not, vector processing continues at the next step.

If the Send All Calls button is pressed after a vector call is terminated, button activation is denied.

- Time of Day Routing

Since a *route-to number* command in a vector can specify the AAR or ARS access codes, the TOD routing algorithm can be used to route the call.

- Timed After Call Work (ACW)

A Timed ACW interval can be assigned to a VDN.

- Timed Reminder

The attendant Timed Reminder is not available for calls placed, transferred, or extended to a VDN. Vectoring causes all other timers to be ignored.

- Transfer

Calls can be transferred to a VDN.

- Traveling Class Mark

A TCM is sent when a *route-to* command dials a seven-digit ETN or 10-digit DDD number via AAR/ARS. This TCM is the FRL associated with the VDN COR.

## Expert Agent Selection

---

See the *DEFINITY Enterprise Communications Server Release 6 Call Vectoring/EAS Guide* for a detailed description of Expert Agent Selection. The guide contains information that is critical to the effective and efficient use of this feature.

Use Expert Agent Selection (EAS) to route incoming Automatic Call Distribution (ACD) calls to the agent who is best qualified to handle the call, that is, the agent with the specialized skills or experience required to best meet the caller's needs.

In addition, EAS provides the following capabilities:

- You assign all agent functions to the agent login ID and not to a physical voice terminal. Therefore, EAS agents can login to and work at any voice terminal in the system.
- Using the agent login ID, a caller places a call directly to a specific agent. These calls can be treated and reported as ACD calls.

EAS ensures the best possible service to the caller.

## How to administer EAS

---

### Required forms

| Form                                  | Field                                   | Page                  |
|---------------------------------------|---|-----------------------|
| System Parameters<br>Customer-Options | ■ ACD                                   | <a href="#">5-277</a> |
|                                       | ■ Expert Agent Selection (EAS)          |                       |
|                                       | ■ EAS-PHD                               |                       |
|                                       | ■ Vectoring (Basic)                     |                       |
| Agent LoginID                         | ■ All                                   | <a href="#">9-193</a> |
| Hunt Group                            | ■ Skill                                 | <a href="#">5-158</a> |
|                                       | ■ ACD                                   |                       |
|                                       | ■ Vector                                |                       |
|                                       | Set all three fields to y. <sup>1</sup> |                       |
|                                       | ■ Group Type (ucd/ead)                  |                       |
| Vector Directory Number               | ■ 1st/2nd/3rd Skill (optional)          | <a href="#">9-214</a> |
| Class of Restriction                  | ■ Direct Agent Calling                  | <a href="#">5-72</a>  |

*Continued on next page*

**Required forms — Continued**

| Form                              | Field   | Page                  |
|-----------------------------------|---|-----------------------|
| CDR System Parameters             | <ul style="list-style-type: none"> <li>■ Record Called Agent Login ID Instead of Group or Member</li> </ul>   | <a href="#">5-63</a>  |
| Call Vector                       | <ul style="list-style-type: none"> <li>■ All</li> </ul>   | <a href="#">9-207</a> |
| Feature-Related System Parameters | <ul style="list-style-type: none"> <li>■ Expert Agent Selection (EAS) Enabled</li> <li>■ Minimum Agent-LoginId Password Length</li> <li>■ Direct Agent Announcement Extension/Delay</li> <li>■ Message Waiting Lamp Indicates Status For</li> </ul> | <a href="#">5-123</a> |

- 
1. If the Message Center field is set to AUDIX on the Hunt Group form, the Skill and ACD fields must be set to y, but the Vector field can be set to either y or n.
- 

EAS must be both optioned on the System Parameters Customer-Options form, and enabled on the Feature-Related System Parameters form. Once EAS is optioned, you can complete most of the EAS-related administration prior to enabling the feature.

When EAS is optioned on the System-Parameters Customer-Options form, Skill Hunt Groups replace splits. In addition, help messages, error messages and field titles change from "Split" to "Skill" on various forms.

Any EAS agent Login ID must be part of the station numbering plan.

Physical aspects of the voice terminal, such as the set type and button layout, are associated with the voice terminal and not the Login ID. On the Station form with the EAS featured optioned, when a work-mode button is selected, no "Gp" information can be entered. The assist and queue status buttons require that "Group" be entered.

**How to administer Direct Agent Announcement**

Direct Agent Announcement (DAA) enhances Direct Agent Calling capabilities for CallVisor Adjunct-Switch Application Interface (ASAI) and Expert Agent Selection (EAS). It plays an announcement to Direct Agent callers waiting in a queue. The following forms should be administered for DAA.

You must also have enabled either Expert Agent Selection (EAS) or ASAI Adjunct Routing (or both).

### Required forms

| Form                                  | Field                                 | Page                  |
|---------------------------------------|---------------------------------------|-----------------------|
| System-Parameters<br>Customer-Options | ■ ACD                                 | <a href="#">5-277</a> |
|                                       | ■ Vectoring (Basic)                   |                       |
|                                       | ■ Expert Agent Selection (EAS)        |                       |
|                                       | OR                                    |                       |
| Feature-Related<br>System Parameters  | ■ Direct Agent Announcement Delay     | <a href="#">5-123</a> |
|                                       | ■ Direct Agent Announcement Extension |                       |
| Announcements/Audio<br>Sources        | ■ All                                 | <a href="#">5-26</a>  |

### Detailed administration for EAS

In general, EAS uses vectors to route calls to agents with the required skills. To administer EAS you must:

- Assign skills to VDNs on the Vector Directory Number form.
- Create vectors that will route a call to the correct skill.
- Assign skills with priority levels to agents on the Agent Login ID form.

### VDN administration

You can administer up to three VDN skill preferences on the Vector Directory Number form in the 1st Skill, 2nd Skill and 3rd Skill fields. These fields indicate the skills that are required to handle calls to this VDN. All of the VDN skills on the VDN form are optional. For example, only the first and third, or only the second and third VDN skills might be assigned. Vector steps can then refer back to these fields to route calls. For example, *queue-to main skill 1st* routes calls the skill administered as 1st on the VDN form.

### Vector administration

When a call routes to a VDN, the VDN directs the call to the vector that is specified on the Vector Directory number form. The vector then queues the call to the skill specified in a vector step. You can write vectors that route calls either to specific skill numbers or to the skill preferences administered on the Vector Directory Number form.



## Agent administration

Assign skills to each agent. In addition, assign a skill level to each skill for the agent. When a vector routes incoming calls to a skill, the call is delivered to an available agent with the skill assigned. If no agents are available, the call is queued until it can be answered by an agent who has the skill required to handle the call.

## Detailed description

### Call distribution

The call distribution method and Call Handling Preference administration determine which agent will receive an incoming call.

#### Call Distribution Method

EAS can use either Uniform Call Distribution (UCD) or Expert Agent Distribution (EAD) routing as the call distribution method. Both methods use the Most-Idle Agent (MIA) algorithm to route calls. The MIA algorithm creates a queue of agents who are available to receive calls. With UCD routing, the queue is a single list of all available agents. When an agent becomes available, he or she is added to the bottom of the list. With EAD routing, the MIA queue is maintained by agent skill level. When an agent becomes available he or she is added to the bottom of the list of agents who have this skill assigned at the same level. Thus when a new call arrives, it is delivered to an available agent at the highest level (most expert).

#### Call Handling Preference administration

Call Handling Preference administration on the Agent Login ID form can route calls based either on greatest need or on agent skill level.

[Table 9-9](#) summarizes how a call is routed based on greatest need or agent skill level administration with either UCD or EAD distribution.

**Table 9-9. Call Handling Preference Call Distribution**

|  | EAD with Skill Level  | EAD with Greatest Need  | UCD with Skill Level  | UCD with Greatest Need  |
|--|---|---|---|---|
| Agents are available. When a new call arrives it is delivered to:                                  | Most-idle agent with the highest skill level for the calls' skill.                        | Most-idle agent with the highest skill level for the call's skill.  | Most-idle agent with the call's skill.  | Most-idle agent with the call's skill.                              |
| Agents are not available, calls are in queue. When an agent becomes available, he or she receives: | Highest priority oldest call waiting for agent's highest level skill with calls in queue. | Highest priority oldest call waiting for any of the agent's skills. | Highest priority oldest call waiting for the agent's highest level skill with calls in queue. | Highest priority oldest call waiting for any of the agent's skills. |

### MIA Across Splits/Skills

In addition, both UCD and EAD can be used in conjunction the MIA Across Splits/Skills option. With MIA Across Splits/Skills, when an agent answers a call from any skill, the agent is removed from the MIA queue for all the skills he or she is logged into.

See, [“Automatic Call Distribution” on page 9-25](#) for more information about UCD, EAD, and MIA Across Splits/Skills.

### Additional Agent Login ID Capabilities

The following capabilities are also associated with agents' login IDs.

- Auto-Answer — When EAS is optioned, auto answer settings can be assigned to agents on the Agent LoginID form. An agent's auto answer setting will apply to the station where the agent logs in. If the auto answer setting for that station is different, the agent's setting overrides the station's.
- Calls — to call an EAS Agent, the caller dials the Login ID extension. The call is extended to the physical extension where the agent with that Login ID is logged in. Calls to the Login ID reach the agent independent of the voice terminal the agent is currently using. For example, when agents use multiple phones because they have multiple offices or rotate desks, login IDs allow these agents to be reached independent of their current location.

- Name — calls to the Login ID display the name associated with the Login ID and not the name associated with the voice terminal. This is also true for calls made from a voice terminal with an agent logged in.
- Coverage — when the agent is logged out, or when calls go to coverage because the agent is busy, or does not answer, calls to the Login ID go to the coverage path associated with the agent and not the voice terminal. When an agent is logged out, calls go to the agent's busy coverage destination.
- Restrictions — calls to the Login ID or from the agent use the restrictions associated with the agent and not the voice terminal.

Voice terminals are fully functional when an agent is not logged in. The restrictions, coverage, and name revert to the voice terminal administration when the agent logs out.

## Direct Agent Calling

Calls to an agent's Login ID are treated as Direct Agent calls if the caller and the agent have the "Direct Agent Calling" class of restriction. Direct Agent calls can be originated by stations or trunks. If the caller or agent does not have the proper COR, the call is treated as a normal non-ACD (personal) call.

Direct Agent Calls are treated as ACD calls. For example they receive zip tone answer, queuing, after call work and are measured by BCMS and CMS.

Any of the agent's skills can be his or her Direct Agent skill. When greatest need is optioned as the Call Handling Preference, the agent will always get Direct Agent calls before any skill calls. This is because Direct Agent calls have a higher priority than skills calls. However, when skill level is optioned as the Call Handling Preference, the agent will get direct agent calls first only if the direct agent skill has the agent's highest skill level. Otherwise calls from a skill with a higher level will be distributed before Direct Agent calls. If the Direct Agent skill and another skill are the same skill level, the agent will always receive Direct Agent calls before the other skill calls because Direct Agent calls have a higher priority.

A *route-to* vector command with an EAS Login ID as the destination is treated as a Direct Agent call if the VDN and agent have the COR and the Direct Agent field is set to "y".

## Considerations

---

Station User records cannot be shared between TTI ports and EAS LoginID extensions. This causes a reduction in the number of possible EAS LoginID extensions allowed by the System depending on the number of administered TTI ports. For example, if 2,000 TTI ports are administered, the maximum number of allowable EAS LoginIDs is reduced by 2,000.

EAS agent Login IDs are also tracked for personal calls. CMS uses the first skill an EAS Agent is logged into to track personal calls. If the first logged-into skill is unmeasured, CMS credits the agent Login ID with the personal call, but no skill hunt group is credited with the personal call.

The system can have either splits or skill hunt groups but not both simultaneously. Non-ACD hunt groups can exist with either splits or skill hunt groups. Skill hunt groups are required when using EAS.

## Interactions

---

Unless otherwise specified, the feature interactions for skill hunt groups are the same as for vector-controlled splits.

- Abbreviated Dialing  
Abbreviated dialing can be used to log in/out EAS agents. Abbreviated dialing lists/buttons can only be administered for stations.
- Add/Remove Skills  
In the EAS environment, agents have the ability to add and remove skills during a login session by dialing a FAC. Other voice terminal users with console permissions can add or remove an agent's skill on behalf of the agent. (Note that the ability to add and remove skills depends on whether a user has a class of restriction (COR) that allows adding and removing skills.)
- Administration Without Hardware  
EAS Login ID extensions are extensions without hardware. Login ID extensions require space in the dial plan.
- Agent Work Mode States  
With EAS, agents can only be in a single work mode at any one time for all their skills.
- Assist  
The Assist feature can be used with a skill hunt group (for example, where there is one supervisor per skill hunt group). When assist is selected, a call is placed to the supervisor associated with the skill for the active call.
- AUDIX  
Calls to the EAS agent Login ID can cover to AUDIX.
- Auto-Available Splits  
If a skill hunt group is administered as an Auto-Available Skill (AAS) the EAS Login IDs assigned to this skill must also be administered as Auto-Available. When the switch reinitializes, these Login IDs are automatically logged in with the Auto-In work-mode. If any switch features attempt to change the work-mode to anything except to Auto-In, this attempt is denied. This feature is not intended for human agents.

- Automatic Answering with Zip Tone

The Automatic Answer option can only be administered for a physical extension.
- Call Forwarding

Skill hunt groups (since they are vector-controlled) cannot be call forwarded. EAS agent Login IDs cannot be forwarded, but the physical extension where the EAS agent is logged in can be forwarded.
- Call Park

Calls cannot be parked on the skill hunt group extension.
- Call Pickup

Skill hunt group extensions and EAS Login ID extensions cannot be members of a call pickup group.
- Class of Restriction (COR)

Skill hunt groups do have a class of restriction. This is used if the skill hunt group extension is called directly.

The COR for an EAS agent Login ID overrides the physical extension's COR of the voice terminal an EAS agent logs into.
- Class of Service (COS)

EAS agents do not have a COS associated with their Login ID. Therefore, the COS of the voice terminal is not affected when an EAS agent logs into that terminal.
- Directed Call Pickup

An EAS agent can use the Directed Call Pickup feature to pick up a call and/or have his or her calls picked up by another terminal user. The Class of Restriction of the agent will override the Class of Restriction of the station where the agent is logged in.

If both the station's COR and the logged-in agent's COR allow the call to be picked up using Directed Call Pickup, the user picking up the call can use either the station's extension or the agent's loginID.
- Displays - Voice Terminal

When an EAS agent logs in, the display for originators who call the Login ID shows the Login ID and agent name (as administered via the Agent Login ID form). Calls that the agent originates show the Agent Login ID and agent name at the receiving terminal's display. However, the user can display the name of the physical terminal where the EAS agent is logged in. To do this, the user must be active on a call with the agent, and must have a terminal with an alphanumeric display and an inspect button. When the inspect button is pressed during a call to or from the EAS agent, the physical terminal name of the agent is displayed.

Calls to the physical extension show the physical extension's number and name on the originator's display.

- Leave Word Calling

EAS agents can retrieve LWC messages left for the Login ID of the agent using the message retrieval button.
- Look Ahead Interflow

VDN skills are not sent to another ACD/PBX when a call interflows using Look Ahead Interflow. If skills have the same meaning on both ACDs, then a Look Ahead Interflow command to a VDN with the same skills assigned can provide a mapping of the skills.
- Message Waiting Lamp

The Message Waiting Lamp by default tracks the status of messages waiting for the logged in EAS agent LoginID rather than messages for the physical terminal. The operation of the Message Waiting Lamp can be changed so that it tracks the status of messages waiting for the physical terminal where the agent is logged in. See [“Feature-Related System Parameters” on page 5-123](#) for more information.
- Queue Status Indications

Physical extensions can be administered with Queue Status Indicator buttons and lamps for skill hunt groups. Queue Status Indicators can be administered for all skills needed by agents using that physical extension, given that enough buttons are available.
- Service Observing

The Service Observing feature is activated in the EAS environment by dialing either the physical extension of the terminal where an EAS agent is logged in or the Login ID of the agent.
- VuStats

VuStats displays can show an agent’s skill assignments and can show some measurements by skill.

## **Inbound Call Management**

---

Inbound Call Management (ICM) allows you to integrate DEFINITY features with host-application processing and routing, and automate delivery of caller information to agents' displays. You can create a sophisticated system to handle inbound calls for applications such as telemarketing and claims processing.

To implement ICM, you integrate DEFINITY features such as Automatic Call Distribution (ACD), Expert Agent Selection (EAS) Call Vectoring, Direct Agent Calling, and Call Prompting with an application on a host processor. The host application, or adjunct, can be a CallVisor/PC, CONVERSANT voice system, Telephony Services Server serving a local-area network, or a vendor application using the CallVisor Adjunct/Switch Applications Interface (ASAI). A CallVisor ASAI link between the switch and adjunct allows the adjunct to control incoming call processing and routing.

In addition, you can automate ACD agent terminal displays and associate them with new and transferred calls, and assist calls to a supervisor. You can display incoming call information such as Calling Party Number (CPN), Billing Number (BN), and Dialed Number Identification Service (DNIS). Or, you can set up the adjunct to retrieve caller information from a database and display it on a particular agent's screen, based on the service dialed.

See ["Detailed description" on page 9-83](#) for more information on applications. See *DEFINITY Communications System Generic 3 CallVisor ASAI Planning* for information on vendor application partners.

### **How to administer ICM**

---

Display the System-Parameters Customer-Options and ensure that the ACD option is enabled. If you are using CallVisor ASAI or Call Vectoring, ensure appropriate ASAI Capability Groups options or the Vectoring (Basic) and/or Vectoring (Prompting) options are enabled.

### Required forms

| Form                                  | Field                             | Page                  |
|---------------------------------------|-----------------------------------|-----------------------|
| System-Parameters<br>Customer-Options | ■ ACD                             | <a href="#">5-277</a> |
|                                       | ■ Vectoring (Basic)               |                       |
|                                       | ■ Vectoring (Prompting)           |                       |
|                                       | ■ ASAI Capability Groups          |                       |
| Trunk Group (ISDN-PRI)                | ■ Per Call CPN/BN                 | <a href="#">7-219</a> |
| Hunt Groups                           | ■ Group Type                      | <a href="#">5-158</a> |
|                                       | ■ ACD                             |                       |
|                                       | ■ Queue                           |                       |
|                                       | ■ Vector                          |                       |
|                                       | ■ Measured                        |                       |
|                                       | ■ Supervisor Extension            |                       |
|                                       | ■ Controlling Adjunct             |                       |
|                                       | ■ Queue Length                    |                       |
|                                       | ■ Calls Warning Threshold         |                       |
|                                       | ■ Calls Warning Port              |                       |
| ■ Time Warning Threshold              |                                   |                       |
| ■ Time Warning Port                   |                                   |                       |
| Class of Restriction                  | ■ Direct Agent Calling (optional) | <a href="#">5-72</a>  |
| Call Vector                           | ■ All                             | <a href="#">9-207</a> |
| Station (agent stations)              | ■ All                             | <a href="#">6-28</a>  |
| Agent LoginID (EAS only)              | ■ All                             | <a href="#">9-193</a> |

- **Trunk Group form** — Administer the Per Call CPN/BN field for the appropriate ISDN-PRI trunk group. The corresponding information is sent with a call-offered event report to the adjunct.
- **Hunt Group form** — Complete a Hunt Group form for each split that the ICM adjunct will monitor.



- **Call Vector** form — If you are using Call Vectoring, an ASAI link interface extension number is required for **adjunct routing** vector commands. This extension is the same as the one you enter on the Station form.

See [“Automatic Call Distribution” on page 9-25](#), [“Call Vectoring” on page 9-63](#), [“Call Prompting” on page 9-60](#) and [“CallVisor Adjunct-Switch Application Interface” on page 4-250](#) and any other features you are implementing for ICM for additional administration requirements.

## Detailed description

### Applications

The following are some typical ICM applications:

- The system passes calling party/billing number (CPN/BN) information and the call is routed to an adjunct application for screen pop and supervisory transfers, with screen duplication.
- The system sends to the adjunct application both caller and prompter information about all incoming calls to a particular number. According to caller information in a database, the application directs the switch to route the call. For example, the call could be routed to a preferred agent, to best customer treatment, or to accounts receivable.
- The system uses Call Prompting to obtain a customer account number and then passes this information to the adjunct for call routing or screen pop.
- The system connects the caller to a voice response unit (VRU), along with caller CPN/BN and DNIS information. The caller then interacts with the VRU to direct how the call is handled. The system can verify a caller's identity and provide access to database information such as claims status or account balance.
- With Direct Agent Calling, an adjunct application can transfer a call to a specific ACD agent and have the call treated as an ACD call and tracked on Call Management System (CMS).
- An adjunct application can attach information used by another application to an ICM call using User-to-User Information fields. The adjunct transfers the call, along with the application-specific information, over primary rate interface (PRI) trunk to a CallVisor ASAI application at another switch. For example, an application at one switch can determine a caller's account or claim number and pass this information to a special list on another switch, where an application will transfer the call.

See *DEFINITY Communications System Generic 3 CallVisor ASAI Technical Reference* for additional application scenarios.

### Agent data screen delivery applications

You can use the CONVERSANT voice system to deliver appropriate display data about callers to agents. You can pass information such as CPN/BN, DNIS, and Lookahead Interflow information, digits collected from Call Prompting, and which agent is selected to a CONVERSANT voice system. CONVERSANT delivers the appropriate data screen to the agent who takes the voice call. CONVERSANT can transfer or duplicate data screens for transferred or conferenced calls. A simplified configuration of this type of application is shown in [Figure 9-2](#). CONVERSANT VIS is used as an example — other adjunct processors have similar capabilities but should be verified for a particular application. If the host supports ASAI, CONVERSANT is not needed.

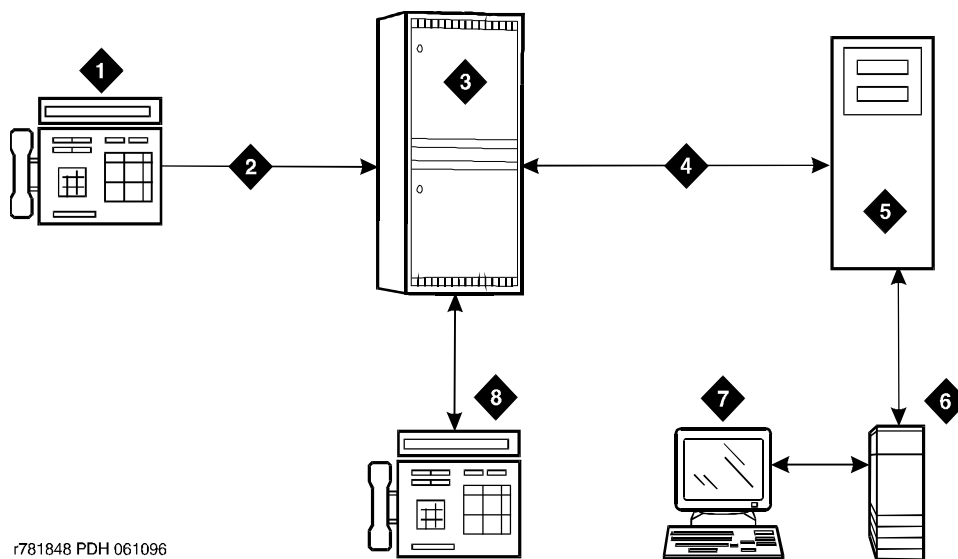

r781848 PDH 061096

#### Figure Notes

- |                   |                         |
|-------------------|-------------------------|
| 1. Voice terminal | 5. CONVERSANT           |
| 2. ISDN-PRI       | 6. Host                 |
| 3. DEFINITY ECS   | 7. Agent data terminal  |
| 4. ASAI           | 8. Agent voice terminal |

Figure 9-2. Simplified ICM Configuration for Data Screen Delivery

General processing for this type of application occurs as follows.

1. The CONVERSANT voice system or host requests notification for events such as call offered, call ended, call connected, call dropped, call transfer, and alerting.
2. The switch notifies CONVERSANT with event reports when the call arrives, when the agent answers, when the call drops, and so on.
3. CONVERSANT sends information to the host application so that it can send a data screen to the agent's data terminal.

CONVERSANT can determine when a call drops before being answered and can track abandoned calls or use CPN/BN information for callbacks.

### **Integration with speech processing adjuncts**

ICM can be used to provide integration with VRUs. The advantages of using ICM with CallVisor ASAI in addition to tip/ring interfaces are as follows:

- Data-screen integration is provided on transferred calls.
- Answer notification is provided on internal calls (CallVisor ASAI capabilities let you know what happens with the call).
- ISDN network information such as CPN/BN and DNIS is delivered to agents (call prompting for this information is not necessary).

A simplified configuration of this application is shown in [Figure 9-3](#).

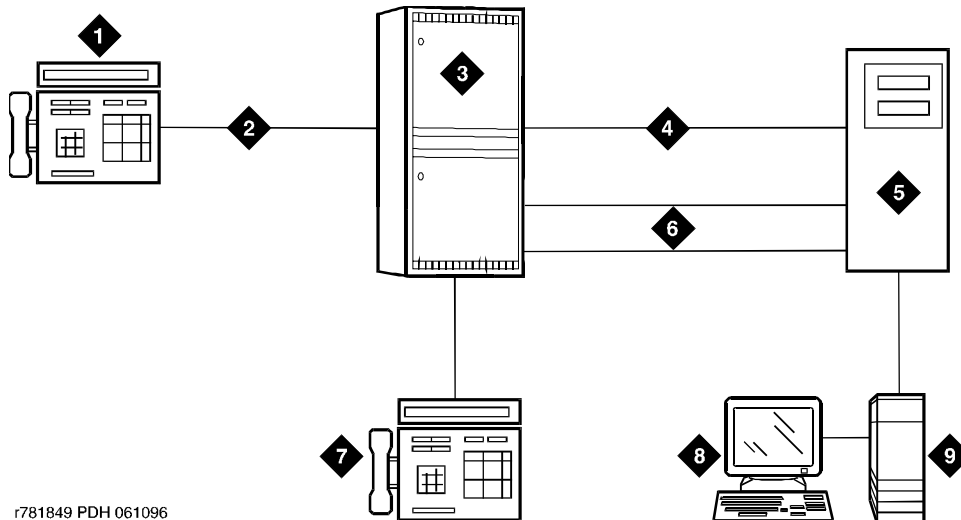

r781849 PDH 061096

### Figure Notes

- |                   |                         |
|-------------------|-------------------------|
| 1. Voice terminal | 5. Speech processor     |
| 2. ISDN-PRI       | 6. Tip/ring lines       |
| 3. DEFINITY ECS   | 7. Agent voice terminal |
| 4. ASAI           | 8. Agent data terminal  |
|                   | 9. Host                 |

Figure 9-3. Simplified ICM Configuration for Speech Processor Integration

General processing for this type of application occurs as follows

1. The switch uses CallVisor ASAI link to pass incoming call information to the CONVERSANT voice system.
2. The ACD split or EAS skill on the switch distributes the call to an available voice line.
3. After digits are collected via a DTMF keypad, CONVERSANT transfers the call back to an ACD split or specific agent on the switch via CallVisor ASAI.
4. If the call is transferred to a split agent, the switch uses CallVisor ASAI link to pass an event report on which agent receives the call.
5. CONVERSANT forwards the agent ID to the host application, which delivers a data screen to the agent.

6. Agents can display collected digits on their data terminals. Except for the dialed number, information from a CONVERSANT voice system cannot be carried with the call and displayed on a voice terminal. For example, digits collected in a CONVERSANT voice system adjunct cannot be passed to the switch for display.
7. If the collected digits are the extension where the call is being routed, these routing digits are passed to the switch as the destination in the CallVisor ASAI third-party make-call request. CONVERSANT uses the request to set up various types of calls.

## Host/adjunct call routing

The host or CONVERSANT adjunct uses incoming call information to route the call to a split, vector, particular agent, or location off the switch. CONVERSANT can also direct the system to handle the call as a priority call. Routing can be based on the caller's area code or country code, digits collected via Call Prompting, dialed number or service, agent availability, or information in a customer database.

To implement this type of call routing, make sure that calls come into a vector that contains an *adjunct routing* vector command. This command causes the switch to initiate the route CallVisor ASAI capability. Vector processing occurs while the caller waits. A default split or answering position can also be specified in the vector, in case CONVERSANT does not respond in the administered amount of time (determined by the announcement/wait steps). Announcement and wait steps are needed to give the host time to respond.

For adjunct routing, if the call queues to a split or leaves vector processing, a route-end request is sent to CONVERSANT.

## Considerations

---

Administrators and planners must consider:

- ICM traffic
- Rated switch capacity
- CallVisor ASAI interface traffic
- Rated capacity of the adjunct application processor

Lucent Technologies Technical Design Center can provide planning assistance.

In addition, you must consider the following:

- CallVisor ASAI and BX.25 CPN/BN-ANI are not supported simultaneously.
- Direct Agent Calls (DACs) are allowed only if the caller and the receiving agent have a Class of Restriction (COR) that allows Direct Agent Calling.

- DACs cannot go through vectors.
- DACs cannot be made over a DCS link. If the receiving agent is not an internal extension, the call is denied.

## Interactions

---

- Call Prompting  
Digits collected by Call Prompting are passed with current call information to a CONVERSANT adjunct.
- Direct Agent Calling  
Direct Agent Calling allows an adjunct to direct a call to a particular ACD agent and have the call treated as an ACD call. Calls that enter the switch as ACD calls and are routed to a particular agent via adjunct routing, or are transferred via a third-party make-call request, are treated as ACD calls for the duration of the call. See [“Automatic Call Distribution” on page 9-25](#) for more information on Direct Agent Calls.
- Priority Calling  
CallVisor ASAI allows both Priority Calling and Direct Agent Calling for the same call.

## Information Forwarding

---

Whenever DEFINITY ECS interflows a call over ISDN trunk facilities (for example, PRI or BRI) by means of a *route-to* (with Lookahead Interflow active), *queue-to best*, or *check best* command, the following information is sent with the call via user-to-user information transport (via UUI IE or QSIG MSI) and can be used by adjuncts or displayed at the receiving switch:

- ASAI user information
- the name of the active VDN (LAI DNIS)
- other LAI information (a time stamp showing when the call entered the current queue, the call's priority level in its current queue, and the type of interflow)
- any collected digits (this does not include dial-ahead digits). These digits are available for processing at remote vectors and/or displaying to the agent.
- the number of seconds that the call has already spent in vector processing (called "in-VDN time")
- Universal Call ID (UCID)

### NOTE:

Sending of information depends on priority settings and activated features.

Forwarding of the last three items, collected digits, in-VDN time, and UCID is new in DEFINITY ECS G3V6.3.

## Interactions

---

- Best Service Routing  
Best Service Routing-related data is sent in addition to the associated ASAI user data and UCID. For more information, see *Call Vectoring/Expert Agent Selection* (555-230-521).

## User-to-User Information Transport

---

In the past, lookahead interflow transported the LAI Information Element (IE) in codeset 6 or 7, which functioned over non-QSIG private networks, but only over certain public networks.

Now, call centers can transport application information (including the LAI information) over many more public ISDN networks because of using User to User Signaling (UUS) Supplementary Services that incorporate user-to-user information (codeset 0 UUI). Information passes over QSIG private networks using manufacturer specific information (MSI—codeset 0 Facility IE) in various messages.

This feature

- enables multiple DEFINITY applications to share the contents of the UUI IE or MSI
- allows for backwards compatibility with pre-R6.3 DEFINITY software.

For more information about how to administer user-to-user information transport, see the Information Forwarding chapter in the *Call Vectoring/Expert Agent Selection (EAS)* guide, 555-230-521.

## Support of new features

Information transport supports these call center features:

- Enhanced Look-Ahead Interflow—routes calls from busy call centers to centers that are less busy.



### NOTE:

Look-Ahead Interflow information can be forwarded using information transport or the traditional codeset 6/7 LAI IE.

- Best Service Routing—routes calls to the best available agents wherever they are.
- Universal Call ID—provides a means to collect and trace call data from multiple call centers.

For information about enhanced lookahead interflow, see [Look-Ahead Interflow on 9-98](#). For information about Best Service Routing, see [Best Service Routing™ on 9-44](#). For information about Universal Call ID, see [Universal Call ID on 9-130](#).

## Administering User-to-User Information Transport

---

This section outlines the procedure to administer your incoming and outgoing trunk groups to send user data over your network. Before administering the trunk group, review these guidelines:

- If you are using shared UUI (any Supplementary Service other than **b**), then you must administer the UUI *Treatment* for the trunk groups (both outgoing and incoming at the remote end) as **shared**. Use this option when you want to forward information to R6.3 or later DEFINITY switches in non-QSIG networks.
- With QSIG (Supplementary Service **b**), you need to administer Shared UUI to include ASAI user information with MSI transport. If UUI *Treatment* is the default **service-provider**, DEFINITY forwards the ASAI user data (if provided) in a non-shared codeset 0 UUI IE while forwarding the other data as MSI.



 **NOTE:**

You do not need to complete this procedure if you do not intend to send user data over the network.

[Table 9-10](#) lists the form and fields needed to administer information transport on trunk groups.

**Table 9-10. Forms needed to administer information transport**

| Form needed                   | Fields needed                      | Why is this field needed?  | Is field optional?   | Page   |
|-------------------------------|------------------------------------|--|--|--|
| ISDN Trunk Group (BRI or PRI) | UUI IE Treatment                   | Set field to either <ul style="list-style-type: none"> <li>■ <b>shared</b> (for trunk groups connected to DEFINITY R6.3 or later if you want shared data).</li> <li>■ <b>service-provider</b> (for trunk groups connected to pre-DEFINITY R6.3 switches or if you want service provider functionality).</li> </ul> | Y<br><br>However, this field cannot be blank.  | for BRI <a href="#">7-208</a><br><br>for PRI <a href="#">7-233</a> |
|                               |                                    | Maximum Size of UUI IE Contents  | Set according to what the network supports. 128 (default) is recommended for private networking. | Y<br><br><a href="#">7-208</a><br><a href="#">7-233</a>            |
|                               | Shared UUI Feature Priority fields | Set the priority for each type of user data (such as UCID, ASAI, and other application information). Only needed for non-QSIG trunk groups.  | Y<br><br>If blank, info not sent.  | <a href="#">7-211</a><br><a href="#">7-236</a>                     |

To administer Shared UUI information transport:

1. In the command line, enter **change trunk-group n** and press RETURN.  
The Trunk Group administration form comes up. *n* is the number of the trunk group you want to administer.
2. Go to page 2 of the form.
3. In the UUI Treatment field, enter **shared** and press RETURN.

 **CAUTION:**

*If the trunk group is connected to a pre-DEFINITY 6.3 switch or if you want service provider functionality, do not enter **shared**. Instead, leave the default **service-provider** in this field. You cannot use*

*Shared UUI unless the trunk group is connected to a DEFINITY 6.3 (or later) switch.*

The `Maximum Size of UUI IE Contents` field appears.

If you enter **shared** and the `Send Codeset 6/7 LAI trunk group` option is on, you send the LAI information twice (unless the LAI Name and Other LAI data items' priorities are blank with non-QSIG—with QSIG, both are always sent), and you may exceed the maximum ISDN message size.

4. If you want to change the default size of 128 in the `Maximum Size of UUI IE Contents` field, then enter the number for the maximum UUI size. If you want to keep the default size, go to Step 5.

You must administer the trunk groups to send the appropriate amount of user information over the connected network. For example, if the public network only supports 32 bytes of user information, and you enter a number larger than 32, the network may reject the entire UUI IE.

DEFINITY accepts a range from 32 to 128.

5. Go to page 4 (the `Shared UUI Feature Priorities` page which comes up only when the `UUI Treatment` field is set to **shared**).

Notice that all feature names (whether enabled or not) appear on this page. The default values were assigned when Shared UUI was enabled.

6. Either leave the default settings, or reassign numbers from 1 to 6 (1 is the highest priority) to each feature. For more information about user needs, see *Determining User Information Needs* in the next section.

 **NOTE:**

If you leave a feature field blank, that feature will not transport in the UUI IE. If the public network supports less than 82 bytes, you need to choose what feature information you want to send, and give that feature field a higher priority.

7. Press **ENTER** to save your changes.

## Determining User Information Needs

The network byte limit on user information contents (the user data part of the UUI IE) must be large enough to carry the data needed for the customer application.

If you want to forward information over a network that does not support at least 82 bytes of user data, you must determine the space required for the application and adjust priorities accordingly. For more information, see “Determining User Information Needs” in the Information Forwarding chapter of the *Call Vectoring/Expert Agent Selection (EAS)* guide, 555-230-521.

## Considerations

---

- Enhanced information forwarding has been tested with several major carriers. To find out if these capabilities work with your carrier, check with your account team for the most current information. If testing has not been done to verify operation over the public networks involved with the preferred specific configuration, use of private ISDN trunking between the nodes should be assumed until successful testing has been completed.
- Any switch that acts as tandem node *must* have priorities assigned to the Shared UUI features for non-QSIG trunk groups. Even if this switch does not create anything, the priorities must be set correctly to pass the information along. For more information, see the Troubleshooting section.
- The `Send codeset 6/7 LAI` trunk group option operates independently of the `UUI IE Treatment` trunk group option. However, if you turn both of these options on, you'll send the same information twice and possibly exceed the maximum ISDN message size. DEFINITY provides a warning message when both options are administered. There are two ways to correct when the user data exceeds the maximum message size, either:
  - put a blank in the priority fields for `VDN Name` and `Other LAI Information` on the Shared UUI Feature Priorities form, or
  - disable the `Send codeset 6/7 LAI` option.
- For non-QSIG or QSIG trunk groups to DEFINITY R6.3 (or later) switches that require information forwarding, the `UUI IE Treatment` should be **shared** and the `Send Codeset 6/7 LAI IE` should be **n**. For more information, see the *DEFINITY ECS Call Vectoring/Expert Agent Selection (EAS)* guide, 555-230-521.
- Information transported via the Shared UUI is DEFINITY-proprietary; the information will not work with non-DEFINITY switches unless these switches adhere to the proprietary encoding.

## Troubleshooting

---

The following troubleshooting hints should be reviewed when information is not forwarded, even though you received no error messages while administering the Shared UUI feature, and all software and connections meet the minimum requirements:

- If DCS is used, make sure *all* ISDN trunks between DEFINITY switches used for DCS or remote AUDIX are configured in the D-channel mode.
- For each ISDN trunk administered with the Shared UUI option, make sure the UUI size does not exceed the UUI IE size that the network can support.
- For all non-QSIG ISDN trunks, make sure the `UUI IE Treatment` field is set to **shared**.

- Make sure trunk group options are set correctly for the application and configuration.
- Applications may fail on networks supporting limited UUI transport. Administration determines which application's UUI will be transported in these cases. If a given application is failing, first check the administration to determine if the application in question has the highest priority. This applies to tandem nodes as well as originating nodes.

Applications that originate UUI on tandem nodes can request that assigned priorities at the tandem node be applied to the resulting UUI. Therefore, it is possible for a tandem node to erase UUI information received from the originator.

In other words, passing UUI through a tandem node transparently as required for UUS Service 1, does not apply to DEFINITY's proprietary shared UUI procedures.

## Intraflow and Interflow

---

Intraflow and Interflow allow you to redirect ACD calls from one split to another split when the splits are not vector-controlled. Intraflow redirects calls to other splits within the system using Call Coverage or Call Forwarding All Calls. Interflow redirects calls to an external split or location using Call Forwarding All Calls.

### Intraflow

---

Use Call Coverage with Intraflow to redirect ACD calls from one split to another *conditionally*, according to the coverage path's redirection criteria. For example, you can define a split's coverage path to automatically redirect incoming ACD calls to another split when a terminal is busy or unanswered. You can redirect calls to less busy splits, for more efficient call handling.

Use Call Forwarding with Intraflow to *unconditionally* forward a split's calls.

### Interflow

---

Interflow allows you to redirect ACD calls from a split on one switch to a split on another switch or external location. Use Call Forwarding All Calls with Interflow to *unconditionally* forward calls directed to a split extension to an off-premises location. Calls can be forwarded to destinations off the PBX (that is, phone numbers on the public telephone network). You cannot use Call Coverage with Interflow. If a coverage point station or split is forwarded/interflowed, it is taken out of the coverage path.

For details on how to forward calls to an external extension, see [“Call Forwarding” on page 4-224](#). See [“Call Vectoring” on page 9-63](#) and [“Look-Ahead Interflow” on page 9-98](#) for information on advanced Interflow capabilities. See [“Call Coverage” on page 4-146](#) for information on Call Coverage redirection criteria.

## How to administer Intraflow and Interflow

### Required forms

| Form                              | Field  | Page                  |
|-----------------------------------|--|-----------------------|
| Feature-Related System Parameters | <ul style="list-style-type: none"> <li>■ Coverage — Don't Answer Interval for Subsequent Redirection</li> </ul>        | <a href="#">5-123</a> |
| Feature Access Code (FAC)         | <ul style="list-style-type: none"> <li>■ Call Forwarding Activation</li> <li>■ Call Forwarding Deactivation</li> </ul> | <a href="#">5-113</a> |
| Hunt Group                        | <ul style="list-style-type: none"> <li>■ Inflow Threshold</li> <li>■ Priority on Intraflow</li> </ul>                  | <a href="#">5-158</a> |
| Coverage Paths                    | <ul style="list-style-type: none"> <li>■ Don't Answer</li> <li>■ Busy</li> <li>■ Number of Rings</li> </ul>            | <a href="#">5-94</a>  |

### Detailed description

Assign an inflow threshold for each split receiving Intraflow and Interflow calls. This threshold prevents a split from receiving new ACD calls if the oldest call in the queue has been there longer than the threshold. If an ACD call is forwarded or redirected through Call Coverage, but cannot be routed to another split or coverage path point, it remains in queue at the original split even though coverage tone may be heard.

For a split with Intraflow and Call Coverage assigned, you can also assign Priority on Intraflow. When an ACD call intraflowing from a split with Priority on Intraflow to a covering split enters the split's queue, that call is placed ahead of nonpriority calls but behind other priority calls already in the queue. All priority calls are answered before any nonpriority calls.

Calls intraflowed via Call Coverage to a covering split are never connected to the first delay announcement at the covering split. Calls redirected via Call Forwarding receive the delay first announcement at the forwarded-to split, but never receive a forced first announcement.

As an illustration of how Intraflow works, assume the following:

- A call is intraflowed from split 1 to split 2 via Call Coverage.
- Split 1 is assigned priority on intraflow.
- Split 2 has a queue with three priority calls and four nonpriority calls.
- Split 2 has an inflow threshold of 90 seconds and the oldest call in queue at split 2 has been in queue for 60 seconds.

- Split 2 has been assigned a second delay announcement and has a second delay announcement interval of 45 seconds.
- Music-on-Hold is provided.

When the call is intraflowed from split 1 to split 2, the call is placed in the split 2 queue as the fourth priority call, ahead of the four nonpriority calls. The call stays in the queue for 45 seconds and is still not answered. Then the call is connected to the second delay announcement for split 2. After the announcement, the caller hears music until an agent answers the call.

You can assign a Coverage ICI button to an agent's multiappearance voice terminal. The agents use the button to identify a call that is intraflowed from another split. When an agent receives such a call, the button lamp lights.

## Considerations

---

The same coverage path can be used for as many splits as desired. You should administer redirection criteria for a split's coverage path so that calls are redirected under Busy or Don't Answer conditions. Do not use All or Send All Calls as redirection criteria.

## Interactions

---

- Call Coverage

All splits with the same coverage path are automatically assigned the same Don't Answer Interval. The default Don't Answer Interval is 2.

If Intraflow via Coverage is active, the Coverage Don't Answer Interval associated with Call Coverage begins when a call enters the split queue.

If the Coverage Don't Answer interval expires before either of the two delay-announcement intervals expires, a call is redirected to coverage. If either of the delay-announcement intervals expires before the Coverage Don't Answer interval, the call is connected to a delay announcement, if available.

If no coverage point is available to handle a call, a call remains in queue and may then be connected to a delay announcement.
- Temporary Bridged Appearance

If an ACD call is routed to a split agent but is intraflowed to another split before being answered, the Temporary Bridged Appearance at the agent's terminal or console is no longer maintained.

## Look-Ahead Interflow

---

Use Look-Ahead Interflow to balance the load of ACD calls across multiple locations. With Look-Ahead Interflow, you can optionally route a call to a backup location based on your system's ability to handle the call within parameters defined in a vector. In turn, the backup system can accept or deny the call also based on parameters defined in a vector.

DEFINITY 6.3 release includes an enhanced Look-Ahead Interflow that

- results in First in First Out (FIFO) or near FIFO call routing via a new conditional
- uses less computer processing resources during Look-Ahead Interflow than pre-DEFINITY 6.3 software.
- provides enhanced, globally-supported information forwarding over public or private ISDN (for example, PRI and BRI) networks using non-QSIG or QSIG protocols. For more information, see [Information Forwarding](#) on [9-89](#).

### NOTE:

The rest of this section assumes you will read the *DEFINITY Enterprise Communications Server Call Vectoring/EAS Guide (555-230-521)* for a detailed description of Look-Ahead Interflow and its uses. The guide contains information that is critical to the effective and efficient use of this feature.



## How to administer Look-Ahead Interflow

### Required forms

| Form                                  | Field  | Page                  |
|---------------------------------------|--|-----------------------|
| System Parameters<br>Customer-Options | ■ Vectoring (Basic)                                    | <a href="#">5-277</a> |
|                                       | ■ ISDN-PRI   |                       |
|                                       | ■ Lookahead Interflow                                  |                       |
| Trunk Group (ISDN)                    | ■ Outgoing Display                                     | <a href="#">7-219</a> |
|                                       | ■ Codeset to Send TCM, Lookahead                       |                       |
|                                       | ■ Supplementary Service Protocol                       |                       |
|                                       | ■ UII Treatment  |                       |
| Feature-Related<br>System Parameters  | ■ Interflow-Qpos EWT Threshold                         | <a href="#">5-141</a> |
| ISDN Numbering -<br>Public/Unknown    | ■ Ext Len  | <a href="#">7-95</a>  |
|                                       | ■ Ext Code   |                       |
|                                       | ■ CPN Prefix   |                       |
| Call Vector                           | ■ Complete a form for each Look-Ahead Interflow vector | <a href="#">9-207</a> |

See [“Call Vectoring” on page 9-63](#) for associated Call Vectoring administration.

- System-Parameters Customer-Options — For full functionality, options must be enabled at both the sending and receiving switches. If Look-Ahead Interflow is not optioned on the receiving switch, interflow still results on a look-ahead basis. However, the forwarded Dialed Number Identification Service (DNIS) (sending switch VDN name) information is ignored and tandem Look-Ahead Interflow is not provided.
- Trunk Group Form (ISDN) — If you do not want the call originator’s display to update on each Look-Ahead Interflow call attempt, look-ahead calls should be routed over trunk groups with the `Outgoing Display` field set to `n`.
- Feature-Related System Parameters Form — Administer the `Interflow-Qpos EWT Threshold` field when working with enhanced Look-Ahead Interflow. Any calls that will be answered before this threshold will not be interflowed (therefore saving CPU resources).
- ISDN Numbering - Public/Unknown Form — Administer a CPN Prefix for each Vector Directory Number (VDN) that maps to a vector used to place Look-Ahead Interflow calls. If you do not, a Look-Ahead Interflow DNIS of all blanks displays on the answering agent’s voice terminal.

For private network non-QSIG connectivity with direct facilities between DEFINITY systems, administer Look-Ahead Interflow DS1/E1 circuit packs with Country Protocol Option 1 independent of the country where the system is located.

## Considerations

---

- LAI has been tested with several major carriers. To find out if these capabilities work with your carrier, check with your account team for the most current information. If testing has not been done to verify operation over the public networks involved with the preferred specific configuration, use of private ISDN trunking between the nodes should be assumed until successful testing has been completed.
- All calls routed over ISDN facilities by a **route-to number with cov n** or **route-to digits with cov n** vector command on a switch where Look-Ahead Interflow is enabled are treated as Look-Ahead Interflow call attempts.

A vector may route a call over an ISDN facility to a destination that is not a VDN. The sending switch processes this call as a Look-Ahead Interflow call even though it is not. ISDN processing at the receiving switch causes the call to always be accepted. However, the DNIS and any other information in the Look-Ahead Interflow information forwarded with the call are ignored.

- Until the lookahead attempt is accepted by the receiving switch, the caller continues to hear any feedback applied by the sending switch vector and will remain in any split/skill queues.
- **Route-to number with coverage y** or **route-to digits with coverage y** commands never result in a Look-Ahead Interflow call attempt. The sending end assumes the call is always going to be accepted. This command always completes the call. Moreover, the command should not be used if the vector at the receiving switch might deny the call, since the caller in this case would be given a busy signal or would be disconnected. Use this command with coverage y only when you want unconditional interflow (with Look-Ahead Interflow active) and the terminating switch is set up accordingly.
- Audible feedback may be provided to the caller before interflow is attempted. Therefore, another audible feedback from the receiving switch may confuse the caller. For example, a caller hearing ringback on the sending switch may be confused if music is applied suddenly when the call interflows to the receiving switch.

## Interactions

---

- AAR/ARS

ISDN facilities used to provide Look-Ahead Interflow to a VDN on another switch in a private network can use the AAR feature if private facilities are to be used for call routing.

- Agent Terminal Display

If collected digits are forwarded with an interflowed call, the forwarded digits are displayed to the answering agent (unless they're overridden with newly collected digits).

- Attendant Control of Trunk Group Access

Calls will not route over a trunk with Attendant Control of Trunk Group Access set.

- Authorization Codes

Authorization Codes must not be required for interflow routing. Assign a high enough FRL to the VDN so that the route desired for routing interflow calls can be used without requiring an Authorization Code entry. If a route choice is encountered that requires a higher FRL, the interflow is considered an invalid destination (rejected for Look-Ahead Interflow or not available for standard interflow) without the application of recall dial tone.

- BCMS

BCMS does not log LAI attempts, nor does it report accumulated in-VDN time.

- Call Detail Recording — Sending Switch

No Ineffective Call Attempt or Outgoing Call CDR records are generated for vector *route-to* commands that are unsuccessful including denied Look-Ahead Interflow attempts.

If a local (on-switch) call to a VDN generates a Look-Ahead Interflow call attempt that is accepted, and answer supervision is returned from the receiving switch, then one Outgoing Call CDR record is generated with the originating extension as the calling number.

If an incoming (off-switch) call to a VDN generates a Look-Ahead Interflow call attempt that is accepted, and no answer supervision is returned from the receiving switch, then one incoming CDR record is generated. The VDN is the called number, and the duration is from the time answer supervision was provided to the incoming trunk.

If an incoming (off-switch) call to a VDN generates a Look-Ahead Interflow call attempt that is accepted, and answer supervision is returned from the receiving switch, then two incoming CDR records are generated:

- An incoming record with the VDN as the called number and the duration as the time since answer supervision was provided to the incoming trunk. This is generated if the call is initially answered in the sending switch before interflow takes place.

— An outgoing record containing the incoming trunk information as the calling number and the dialed digits and the outgoing trunk information as the called number.

■ Call Detail Recording — Receiving Switch

On the receiving switch, an incoming Look-Ahead Interflow call is treated like any other incoming vector call.

If answer supervision is returned by the vector, and the call is never terminated to another destination, then the VDN extension is recorded as the called number in the CDR record.

If the call terminates to a hunt group, then the VDN, hunt group, or agent extension is recorded as the called number. If the `Record VDN in Record` field of the Feature Related System Parameters is `y`, then the VDN extension overrides the `Call to Hunt Group - Record` administration option for vector calls.

■ Call Prompting

Digits collected at the sending switch, no matter how they are collected (caller-entered, ASAI provided, CINFO provided, etc.) are forwarded with interflowed calls and available at the remote switch via information forwarding. For more information, see [Information Forwarding](#).



**NOTE:**

Dial-ahead digits are not forwarded with the call. There is a maximum of 16 forwarded digits.

■ Centralized Attendant Service

A centralized attendant can be a Look-Ahead Interflow destination.

■ Display - 27 Character

The VDN name (part of the LAI information forwarded with calls) can be up to 15 characters long. Any characters over this limit will be dropped.

■ Facilities Restriction Level and Traveling Class Marks

The FRL for interflow over ARS/AAR route choices is assigned to the original VDN used for the incoming call.

■ Incoming Call Management

The adjunct routing capabilities of vectoring can be used at the sending switch to determine if a call should be interflowed. Adjunct routing at the receiving switch can be used to tandem the call to a far-end switch.

If the call terminates to a trunk (tandem), then two CDR records are generated:

— An incoming record with the VDN as the called number and the duration as the time since answer supervision was provided to the incoming trunk.

- An outgoing record containing the incoming trunk information as the calling number and the dialed digits and the outgoing trunk information as the called number.
- Lucent Distributed Networking - Manufacturers Specific Information (MSI)  
LAI (whether enhanced or not) may not function with systems from other vendors (unless that vendor develops a corresponding capability that works with DEFINITY ECS).
- Network Access  
LAI operates over public, private, or virtual private (for example, SDN) ISDN-BRI and -PRI networks that meet minimum network requirements.  
The sending of a Look-Ahead Interflow codeset 6/7 information element is counted toward Message Associated User-to-User Information (MA-UUI) counts.
- QSIG  
LAI and information forwarding function over QSIG trunk facilities if the remote locations are DEFINITY systems. You may get LAI call control functionality with other vendors if DEFINITY is the starting point.
- Redirect on No Answer (RONA)  
Calls redirected to a VDN by RONA can be subsequently processed and routed by LAI applications.
- Service Observing  
You can observe a call in LAI processing via VDN observing throughout the life of the call (as long as the call is still connected through the local DEFINITY ECS). All current restrictions on Service Observing still apply. Incoming calls can be service observed at the remote switch.
- Trunk-to-Trunk Transfer  
Interflowed calls may be transferred by a receiving switch to another trunk connection.
- VDN Override  
The name of the active VDN for a call is displayed at the remote answering agent.

## Multiple Call Handling

---

Multiple Call Handling (MCH) allows agents to receive an ACD call while other types of calls are alerting, active, or on hold.

### How to administer MCH

---

#### Required forms

---

| Form       | Field                    | Page                  |
|------------|--------------------------|-----------------------|
| Hunt Group | ■ ACD                    | <a href="#">5-158</a> |
|            | ■ Multiple Call Handling |                       |

The MCH column on the List Hunt Group form contains the value that you enter in Multiple Call Handling.

### Detailed description

---

#### Applications

Use Multiple Call Handling in applications where you want agents to take additional calls without dropping the active call. Examples of applications include:

- An agent and a caller may need to wait on a call for information. MCH allows the agent to put the call on hold and handle other ACD calls until information is available.
- ACD calls may be more important to your business than non-ACD calls. Use MCH to interrupt agents on non-ACD calls with an ACD call.
- In an EAS environment, calls from one skill may be more important than calls from another skill. Use MCH to interrupt an agent who has a call from the less-important skill with a call from the more-important skill.

You can use MCH in an Expert Agent Selection (EAS) or non-EAS environment.

- With EAS, you can administer any combination of MCH and non-MCH skills for an agent. If an EAS agent is a member of both MCH and non-MCH skills, he or she can handle multiple simultaneous ACD or Direct Agent Calls only in the MCH skills.
- Without EAS, agents can be logged into only one split if it is an MCH split. Similarly, a non-EAS agent logged in to a non-MCH split cannot log into an MCH split.

## MCH example

In this example, an agent is logged into 4 skills, each with a different MCH option. [Table 9-11](#) shows how calls are delivered when an unrestricted-line appearance is available and the agent is in Auto-In or Manual-In work mode (AUX work mode is not pending).

**Table 9-11. MCH Call Delivery Example**

| Condition  | Calls Delivered?                |                                 |                                     |                                      |
|--|---------------------------------|---------------------------------|-------------------------------------|--------------------------------------|
|  | Skill 1<br>(MCH=<br>on-request) | Skill 2<br>(MCH=<br>one-forced) | Skill 3<br>(MCH=one<br>- per-skill) | Skill 4<br>(MCH=<br>many-<br>forced) |
| No calls on set                                  | yes                             | yes                             | yes                                 | yes                                  |
| One active extn call                             | no                              | yes                             | yes                                 | yes                                  |
| Skill 1 call active                              | no                              | yes                             | yes                                 | yes                                  |
| Skill 2 or 4 call active                         | no                              | no                              | yes                                 | yes                                  |
| Skill 3 call active                              | no                              | no                              | no                                  | yes                                  |
| Extn call held, no other action                  | no                              | yes                             | yes                                 | yes                                  |
| Skill 1, 2, or 4 call held, no other action      | no                              | no                              | yes                                 | yes                                  |
| Skill 3 call held, no other action               | no                              | no                              | no                                  | yes                                  |
| Extn call held, then AI/MI selected              | yes                             | yes                             | yes                                 | yes                                  |
| Skill 1,2,3, or 4 call held, then AI/MI selected | yes                             | yes                             | yes                                 | yes                                  |

Agents and supervisors in on-request MCH splits or skills can use Queue Status, VuStats, and BCMS/CMS reports to determine if a call is waiting that must be answered immediately.

## MCH settings

### On request

In on-request splits or skills, the following is true.

- If an agent goes into Auto-In or Manual-In work mode, but there are no calls in the queue, the agent is placed at the bottom of the MIA queue or at the bottom of their skill level in the EAD queue, or is made available in the DDC queue.

- Agents must select Auto-In or Manual-In work mode for each new ACD call they take while a call is on hold.
- The agent can take additional ACD calls as long as there is an available line appearance.

Use on-request MCH in conjunction with a feature such as VuStats, which agents can use to see when the split queue is getting full and take additional calls.

### One forced

An agent who is idle or active on a non-ACD call is automatically interrupted with an ACD call from this split or skill when no other ACD call for any of the agent's splits or skills are alerting, active, or held. In addition, the following must also be true:

- The agent is in Manual-In or Auto-In work mode.
- The agent is the most idle or next available.
- An unrestricted line appearance is available.
- AUX work or Move from CMS are not pending.

As long as an ACD call is active or held, the agent does not automatically receive an additional call from the one-forced split or skill. An agent in a one-forced split/skill in Auto-In or Manual-In work mode is unavailable for that split/skill from the time that an ACD call rings until all ACD calls are abandoned, redirected, or dropped. However, the agent can request another ACD call from a one-forced split or skill by placing the active call on hold and selecting Manual-In or Auto-In work mode.

If an agent with multiple skills is active on an ACD call for a group with one-forced MCH, the agent could be forced to take an ACD call for one of his or her other skills, depending on that skill's MCH settings.

Because one-forced MCH forces an ACD call to alert an agent who is not on an ACD call, use it when you want ACD calls to take precedence over other calls.

### One per skill

You must have EAS to use one-per-skill MCH. An agent with no ACD calls for this skill is automatically interrupted with a single ACD call from this skill under the same conditions listed for one-forced.

If a one-per-skill call is active or held, the agent does not automatically receive additional calls from that skill. However, the agent can request another ACD call from a one-per-skill in the usual way.

If an agent with multiple skills is active on an ACD call for a one-per-skill group, the agent could be forced an ACD call for one of his or her other skills if those skills are many-forced or one-per-skill MCH.



Use one-per-skill MCH when calls from one skill are of higher priority than other ACD calls.

### **Many forced**

Agents are automatically interrupted with an ACD call under the same conditions listed for one-forced. As soon as an agent answers an alerting ACD call, the agent immediately becomes available to receive another ACD call from a many-forced split or skill.

Agents in many-forced groups in Auto-In or Manual-In work mode are unavailable only when an ACD call is ringing.

Use many-forced MCH when agents must answer important or urgent calls, even when they must put equally important calls on hold. It can also be used to force Direct Agent calls to an agent.

## **Considerations**

---

- Agents can receive multiple calls only when in Auto-In or Manual-In work mode. All forced MCH calls are delivered with ringing at the agent's station, not with zip tone. Requested MCH calls are delivered with ringing or zip tone.
- Agents can toggle between Auto-In and Manual-In work mode.
- If an agent selects ACW or AUX work mode with calls on hold, the work mode is pending until all calls complete or until a Manual-In call completes. New ACD calls are not delivered when AUX work is pending. When an ACD or Direct Agent call with pending ACW completes, the agent enters ACW. When an agent is active on a non-ACD call with ACW pending, the agent can receive forced MCH calls.
- If an agent is either in Auto-In work mode and active on an ACD or Direct Agent call, or in Auto-In or Manual-In work mode and active on a non-ACD call and a Manual-In ACD or Direct Agent call abandons from hold, the agent is pending for ACW work mode and the after-call button lamp flashes.
- If an agent reconnects to an ACD or Direct Agent call on hold, his or her work mode changes to the call's work mode (Auto-In or Manual-In).
- Do not use forced MCH with DDC distribution because the first agent continues to receive calls until all line appearances are busy.

## Interactions

---

- Automatic Hold

To answer a ringing ACD call, an agent in a many-forced, one-forced, or one-per-skill split/skill pushes the line-appearance button. If automatic hold is administered, the active call is automatically placed on hold. Otherwise, the agent must first push hold.

- Call Work Codes and Stroke Counts

Agents handle multiple ACD calls simultaneously with MCH can enter CWCs and Stroke Counts. When an agent does so with multiple calls on the station, the code/count is associated with the last call the agent handled. If an agent enters a code/count during an active call with calls on hold, the code/count is associated with the active call.

If an agent with on-request MCH is active on a call that requires forced entry of CWC or stroke counts and places the call on hold without entering a code/count, he or she cannot request another call.

If agents with many-forced MCH are in a split/skill with forced entry of CWC or stroke counts, they are forced to handle an ACD call even if they have not entered a code/count.

- Direct Agent Calling

Agents can handle multiple Direct Agent calls if their direct agent skills have MCH. The queue-status indicator is not lit when a Direct Agent call queues to a split/skill. Agents are notified that calls are waiting with a ringing and a flashing current-work-mode lamp.

- Move Agent While Staffed

An agent with a move pending can place a call on hold and request another ACD call. All calls and ACW must complete before the pending move occurs.

- Non-ACD calls

If an agent activates Auto-In or Manual-In work mode with calls on hold, he or she can answer or originate a non-ACD call. With on-request MCH, the agent is temporarily unavailable for ACD or Direct Agent calls. With forced MCH, a call can be delivered. If an agent in ACW reconnects to an AUXIN/AUXOUT call, the agent remains in ACW.

- Queueing

When an agent is available, the agent is placed at the end of the queue for Uniform Call Distribution (UCD) hunt groups or at the bottom of the skill type for Expert Agent Distribution (EAD) hunt groups, or is made available for Direct Department Calling (DDC) hunt groups. When the agent becomes the most available according to group type (UCD, EAD, or DDC), he or she receives a queued ACD or Direct Agent call.

If the last agent on a forced MCH split is pending for AUX work mode in a nonvector-controlled split, the agent must empty the queue before going to AUX work mode. The agent continues receiving ACD calls until the queue is emptied.

- Redirection on No Answer

If an agent has a call active or on hold and the RONA timer expires for another ringing ACD call, RONA redirects the alerting call back to the split/skill or administered VDN. The agent is not taken out of service when the call redirects, but is placed at the bottom of the Most Idle Agent (MIA) or Expert Agent Distribution (EAD) queue.

- Restricted line appearance

If you administer last-available line appearance as Restricted Last Appearance for an agent's terminal, the agent does not receive additional ACD calls because the appearance is reserved for making conference or transfer calls.

## Queue Status Indications

---

Queue Status Indications allows you to assign queue-status indicators for Automatic Call Distribution (ACD) calls based on the number of calls queued and time in queue. You can assign these indications to lamps on agent, supervisor, or attendant terminals or consoles to help users monitor queue activity.

In addition, you can define auxiliary queue warning lamps to track queue status. On voice terminals and consoles with displays, you can display the number of calls queued and time in queue of a split's oldest call.

### How to administer Queue Status Indications

---

#### Required forms

---

| Form                          | Field  | Page                  |
|-------------------------------|--|-----------------------|
| Hunt Groups                   | ■ Queue Length   | <a href="#">5-158</a> |
|                               | ■ Calls Warning Threshold (per split or attendant group) |                       |
|                               | ■ Time Warning Threshold (per split or attendant group)  |                       |
|                               | ■ Time Warning Port (per split)                          |                       |
|                               | ■ Calls Warning Port (per split)                         |                       |
| Station<br>(multi-appearance) | ■ Button/Feature Button Assignments                      | <a href="#">6-14</a>  |
|                               | — q-calls  |                       |
|                               | — q-time   |                       |
| Attendant Console             | ■ Feature Button Assignments                             | <a href="#">5-35</a>  |
|                               | — atd-qcalls   |                       |
|                               | — atd-qtime  |                       |
|                               | — q-calls  |                       |
|                               | — q-time   |                       |
| System Capacity               | ■ Queue Status Buttons                                   |                       |

---

## Detailed description

---

There are two types of Queue Status Indications:

- Number of queued calls (NQC)  
The system report the total number of calls, excluding direct agent calls (DACs), in queue at a hunt group.
- Oldest queued time (OQT)  
The system reports the time in queue of the oldest call in a split queue.

You can also use auxiliary queue warning lamps to provide both types of indications. Install the lamps at any location convenient to split agents.

If a queue status threshold is reached, the lamp next to the associated button flashes. If calls are queued but the threshold is not reached, the lamp lights steadily. If no calls are queued, the lamp goes dark.

If agents at voice terminals and consoles with displays press either the OQT or NQC button, the following information is briefly displayed:

- Split name (or extension, if name is not assigned)
- Oldest queued time
- Number of queued calls

You can use Queue Status Indications to provide status information for attendant groups or other hunt group types (DDC and UCD). With attendant groups, the button names (AQT and AQC) are different than for split queues, the display shows OPERATOR instead of split name or extension, and all status information applies to the attendant group queue.

If you need to know how many queue status buttons you've administered, or how many your system will allow you to administer, check page 5 of the System Capacity form.

## Interactions

---

- Attendant and Voice Terminal Displays Timer  
The timer and the queue status information can be displayed at the same time. On 1-line displays, the timer is displayed in the last eight display positions and the number of queued calls is not displayed. On 2-line displays, the timer is displayed on the first line and the queue status information is displayed on the second line.
- CMS  
When you use CMS to move an agent from one split to another, all buttons associated with the first split, including NQC and OQT buttons, become associated with the second split.

## Reason Codes

---

Reason Codes allows agents to enter a numeric code that describes their reason for entering Auxiliary (AUX) work mode or for logging out of the system. Reason codes give call center managers detailed information about how agents spend their time. Use this data to develop more precise staffing forecasting models or use it with schedule-adherence packages to ensure that agents are performing scheduled activities at the scheduled time.

You can administer the codes so that entry is forced or optional. Ten reason codes are available, including a default code. You can assign two system-wide names to each code — one for entering AUX work mode and one for logging out.

You can use VuStats to display the reason code name or number. Use VuStats or CMS to gather historical and real-time reason-codes statistics.

You must have Expert Agent Selection (EAS) enabled to use reason codes.

### How to administer Reason Codes

---

#### Required forms

| Form                                    | Field   | Page                  |
|---|---|-----------------------|
| System Parameters<br>Customer-Options   | ■ ACD   | <a href="#">5-277</a> |
|   | ■ EAS   |                       |
|   | ■ Reason Codes  |                       |
| Attendant Console                       | ■ RC  | <a href="#">5-35</a>  |
| Feature-Related<br>System Parameters    | ■ EAS   | <a href="#">5-123</a> |
|   | ■ Aux Work Reason Code Type                                 |                       |
|   | ■ Logout Reason Code Type                                   |                       |
|   | ■ CMS Release (Release 5 and later configurations, or none) |                       |
| Feature Access Code<br>(FAC) (optional) | ■ Aux Work Reason Code Type                                 | <a href="#">5-113</a> |
|   | ■ Logout Reason Code Type                                   |                       |
| Language Translations                   | ■ Line 49   | <a href="#">5-193</a> |
| Reason Code Names                       | ■ All   | <a href="#">5-193</a> |
| Station                                 | ■ RC  | <a href="#">6-28</a>  |

## Detailed description

### Forced reason codes

If you have administered forced reason codes, agents cannot enter AUX work mode or log out until they enter a code. Agents can enter codes 1 — 9, but not default code 0.

If an agent enters an invalid code or fails to enter a code within the administered timeout interval, the change is denied and the agent remains in the current work mode. If the agent dialed a FAC, the agent hears an intercept tone. If the agent pressed the AUX button, the AUX lamp flutters and then goes dark (or lights steadily if the agent was already in AUX with a different reason code).

### Requested reason codes

If you have administered requested reason codes, agents need not enter a code to enter AUX work mode or log out. Agents can enter the codes 0 — 9. If an agent enters an invalid code or fails to enter a code within the timeout interval, the agent enters AUX work mode or logs out with default code 0.

### Entering AUX work mode

An agent can enter an AUX reason code in one of three ways:

- Pressing an AUX work button with an assigned code
- Pressing an AUX work button with no assigned code and responding to the prompt for a reason code
- Dialing an AUX work FAC and responding to the dialtone prompt for a reason code

If there are no calls ringing, active, or held at the voice terminal, agents enter AUX work mode immediately and the AUX lamp lights steadily. Otherwise, the AUX lamp blinks until the agent completes all calls at the terminal.

If a button for AUX work is associated with the reason code that the agent entered, the button lamp lights. If no such AUX button exists, the system lights the first AUX button lamp with no administered reason code.

You can assign an AUX button without a reason code to an agent's voice terminal. This allows agents with a limited number of buttons to use all 10 reason codes.

### Logging out

To log out with a reason code, the agent dials the logout FAC, hears a second dial tone and enters a reason code. The agent hears confirmation tone and is logged out.

## Default code

Default code 0 is used when the system puts an agent into AUX work mode or logs the agent out without the involvement of the agent. For example:

- When an agent logs in and is put into AUX mode
- When an agent makes or receives a non-ACD call from the available state
- When a call is redirected as a result of Redirection on No Answer (RONA) and the agent is logged out or put into AUX mode
- When agent skill assignments are changed while an agent is staffed (the system automatically logs the agent out and back in)
- When an agent forces a logout without entering a code (for example, by pulling the headset)
- When an agent who is requested to enter a reason code fails to enter a valid code within the 10-second timeout period
- When an agent with requested reason codes enters # or \*

## Considerations

---

- If an agent in Auto-In or Manual-In work mode dials the logout FAC but fails to enter a reason code and logout reason codes are forced, the agent is returned to the available state. ACD calls are delivered even if the agent has left the voice terminal. To prevent this, be certain that agents enter AUX or ACW work mode before logging out.
- When an agent changes to AUX work mode and the AUX Work Reason Code Type is set to none, the agent is put into AUX work mode with the default reason code even if you have administered a different reason code for the AUX button. Setting AUX Work Reason Code in this way allows you to complete button administration before activating the feature.
- Do not administer AUX buttons without a reason code for hybrid station sets.
- When an agent in AUX work mode is active on a non-ACD call, the agent cannot immediately change the reason code. A change is pending until the call drops.
- There is a limit to the number of agents who can simultaneously be entering either a reason code or a Call Work Code. See the *DEFINITY Enterprise Communications Server Release 6 System Description Pocket Reference* for this limit.



## Interactions

---

- **Abbreviated Dialing**

You can program FACs for AUX work mode or logout with or without an associated Reason Code on automatic-dial buttons or in abbreviated-dial lists. At the reason code prompt, when an agent selects an abbreviated-dial or automatic-dial button, the first digit of the button is taken as the reason code.
- **Agents in Multiple Skills**

When an agent who is assigned to multiple skills enters AUX work mode with a reason code, the agent enters AUX work for all of his or her skills with the same reason code.
- **ASAI**

ASAI allows a host to log an agent out and place an agent in AUX work mode with a reason code. The host can query the agent's current work mode and receive the reason code associated with the AUX work mode.
- **Auto-Available Split**

The system logs AAS agents out for Redirection on No Answer with the default reason code.
- **Basic Call Management System**

Statistics about AUX work mode by reason code are not available in BCMS reports.
- **CMS**

CMS tracks time in AUX work mode by reason code and displays reason codes for agents currently in that mode. When an agent is moved from CMS while the agent is staffed, the system logs the agent out using the default code, and then logs the agent back in again. If an agent is in AUX work mode when moved, the agent is returned to AUX work mode with the same reason code when the move is completed.
- **Direct Agent Calling**

When a Direct Agent call is queued for an agent in AUX work mode with a reason code, the appropriate AUX button lamp flutters to alert the agent to the queued call. If there is no AUX button lamp, agents receive an audible alert (ring-ping or call-waiting tone). If there is an AUX button with no assigned reason code administered, then that lamp flutters.
- **Redirection on No Answer**

When a call is redirected via RONA, an agent is placed into AUX work mode with the default code or is logged out with the default code if the agent is in an auto-available skill.

## Redirection on No Answer

---

Redirection on No Answer (RONA) redirects a ringing ACD split or skill call or Direct Agent Call after an administered number of rings. RONA prevents an unanswered call from ringing indefinitely. The call can redirect either to the split or skill to be answered by another agent or to a VDN for alternative call handling. Direct Agent Calls route to the agent's coverage path, or to a VDN if no coverage path is administered.

You must have ACD enabled to use RONA. Administer RONA for each ACD split hunt group as required. RONA can be used in Auto-Available Splits (AAS), or in splits and skills with agents operating in Manual-In work mode. You can administer RONA for vector-controlled or nonvector-controlled splits or skills.

Do not administer RONA for splits controlled by adjuncts or AUDIX or for auto-answer agents assigned splits or skills because calls must ring at a terminal to be redirected.

### How to administer RONA

---

#### Required forms

| Form                    | Field                                | Page                  |
|-------------------------|--------------------------------------|-----------------------|
| Hunt Group              | ■ ACD                                | <a href="#">5-158</a> |
|                         | ■ AAS                                |                       |
|                         | ■ Vector                             |                       |
|                         | ■ Controlling Adjunct                |                       |
|                         | ■ Message Center                     |                       |
|                         | ■ Redirect On No Answer (Rings)      |                       |
|                         | ■ Redirect to VDN                    |                       |
| Station (multifunction) | ■ Button Assignments<br>— noans-alrt | <a href="#">6-14</a>  |

You must set Controlling Adjunct to **none**.

### Detailed description

---

When RONA is invoked for a call, the system:

- Places an agent in AUX work mode, and thus unavailable to receive calls from other splits or skills. In an AAS, the agent is logged out.

- Redirects split or skill calls back to the split or skill or administered VDN.  
Redirected calls are queued at the highest priority so that they are distributed before any other split or skill calls. See [“RONA Routing Sequences” on page 9-118](#) for more information about call redirection.
- Sends a message to CMS.  
When a RONA timeout occurs, the Noans-alm lamp for the split/skill lights steadily. The supervisor presses the Noans-alm button to display the login ID or the extension and name of the last agent timed out with RONA.
- Records the redirection in BCMS or CMS. See [“Using BCMS/CMS reports with RONA” on page 9-119](#) for additional information.

## Application examples

### VRU applications

Typically, RONA is used with VRU applications in AAS configurations. RONA detects VRU failures and provides alternate operation. For example, an adjunct port failure is not detected by ACD call processing. RONA detects the failure, takes the port out of service, and provides notification of the failure.

Use Call Vectoring for flexible call handling in case of a VRU failure. Assign RONA a converse split connected to the Conversant or to equivalent VRU ports. Whenever RONA times out on a ringing call delivered via the *converse-on* command to a VRU port, the agent is logged out and the call is redirected back to the converse split.<sup>1</sup> With a complete VRU failure, all VRU ports are eventually logged out and vector processing for the *converse-on* command bypasses that step for new calls.

The [Screen 9-1](#) vector shows how to provide automatic backup for a complete VRU failure.

```
CALL VECTOR
01 wait-time 0 secs hearing ringback
02 converse-on split... (VRU returns the digit "1" as a return code
    followed by additional digits for the application)
03 collect 1 digits after announcement none
04 goto step 6 if digits = "1"
05 goto vector xxx (for backup when the VRU fails)
06 collect 2 digits after announcement none
07 ...
```

### Screen 9-1. Call Vector

---

1. RONA can't redirect a call to an administered VDN from a *converse* step.

In [Screen 9-1](#), the application works as expected as long as the VRU returns the digit string, which includes a return code of 1. In this case, the condition in Step 4 is satisfied and the program branches to Step 6, which provides normal application processing.

On the other hand, if all VRU ports in an AAS split are logged out by a RONA timeout, the *converse-on* command step (Step 2) is skipped, and no digits are collected by Step 3 (after the 10-second timeout). The condition in Step 4 is not satisfied and vector processing proceeds to Step 5, which branches to vector xxx to connect the call to an agent.

### Other applications

You can use RONA for applications that involve human agents with manual answering and other adjunct applications, such as Home Agent. For example, a call may not be answered because an agent left without entering AUX work mode or logging out. You can use RONA to make the nonanswering agent unavailable and redirect calls to another agent or to the RONA VDN.

## RONA Routing Sequences

[Table 9-12](#) and [Table 9-13](#) describe how RONA redirects split or skill calls and Direct Agent calls.

**Table 9-12. RONA Routing Sequence for Direct Agent Calls**

| Redirection Destination | Explanation   |
|-------------------------|---|
| Coverage path           | Direct Agent calls redirect to a coverage path, if one exists. Priority calls do not route to coverage.   |
| RONA VDN                | If no coverage path exists but a VDN is administered for RONA, Direct Agent calls redirect to the VDN.  |
| VDN return destination  | For external calls, if neither a coverage path nor a RONA VDN are administered, then Direct Agent calls redirect to the VDN Return Destination extension. |
| None                    | Calls continue ringing.   |

**Table 9-13. RONA Routing Sequence for Split/Skill Calls**

| Redirection Destination | Explanation  |
|-------------------------|--|
| RONA VDN                | If a RONA VDN is administered, calls redirect to the VDN.  |
| Requeue to split/skill  | If a RONA VDN is not administered, calls redirect to the split or skill.   |
| Coverage path           | In nonvector-controlled splits, if calls cannot requeue to the split, they redirect to the split's coverage path if one is administered.                         |
| VDN return destination  | For external calls, if a split coverage path or a RONA VDN is not administered and calls can not requeue, they redirect to the VDN Return Destination extension. |

### Using BCMS/CMS reports with RONA

You can use BCMS and CMS reports to determine which agents had RONA timeouts and how calls were redirected.

With R3V2 and later releases of CMS, the exception report lists agents who were timed out and made unavailable. With BCMS and earlier releases of CMS, you can determine which agents were in AUX work mode or logged-out with AAS.

With R3 CMS, you can use the real-time "Split Status" report to see which agents are in AUX work mode, but you need a custom report to see logged-out agents.

With BCMS, use SAT to create a list of unstaffed agents for the split to see which agents are logged out (for AAS applications). With EAS, list agent-loginid specifying unstaffed and AAS = yes.

With BCMS, agents' changes to AUX work mode appears in the BCMS Split (AGENT) Status report. In an AAS split, agents log out, so they do not appear in the Split Status report. When the call is requeued, the System Status report shows only the AVG ANSW SPEED time and AVG ABAND TIME time for the requeued call. The Historical Split and System reports show both a FLOWOUT (primary split) and FLOWIN (redirected split) for requeued calls, while the VDN report shows only a FLOWOUT.

Direct Agent calls are recorded as ACD split calls but the flowout is recorded only if an agent's coverage path requeues the call to a split.

Since BCMS does not report exceptions, RONA events are not reported. If you have BCMS, use the RONA split lamp indicator for RONA event indication.

## Returning AAS agents to service

When RONA redirects a call that was directed to an AAS, the agent is logged out. To return an AAS agent to service, readminister the agent as a member of the AAS split to be logged in again in one of the following ways:

- For ACD splits, remove the agent from the split and then resubmit the split Hunt Group form with the agent added to it. Alternatively, administer the agent in a different location in the split members list on the Hunt Group form. Use the *list unstaffed-agents* command to get a list of all AAS agents that have been logged out, not just AAS agents that were logged out because of a RONA timeout.
- For EAS skills, readminister the Agent LoginID form so that the AAS agent is automatically logged in. To determine which EAS agents are logged out, use the *list agent-loginid* command.
- For ACD splits and for EAS skills, you can busy-out the AAS agent station with the *G3-MT busyout station* command and release it with the *release station* command. Releasing the AAS agent station automatically logs the agent in. If all AAS agent ports on the circuit pack had a RONA timeout, busy-out and release the entire circuit pack.
- Use CMS Move Agents to move up to 32 agents at a time into a dedicated unused split/skill and then move the agents back into the AAS split/skill. You can set this up using the timetable on a manual-scheduled basis to activate when the VRU has been restored to service after a failure.
- Use ASAI to log the logged-out agents back in via ASAI login request messages.

## Considerations

---

- RONA can timeout while an agent is actually at the terminal if the agent does not answer soon enough or has selected another work mode while a call is ringing. RONA handles the call as usual, making the agent unavailable. With ACD splits, agents at multifunction terminals know that they have been made unavailable when they see the AUX-Work lamp lit. They press the Auto-In or Manual-In button to become available.
- Specify a coverage path or VDN for redirection for nonvector-controlled splits or for Logical Agent IDs with EAS Direct Agent Calls to ensure that calls are always redirected.

## Interactions

---

- AAS

Use AAS with RONA for VRU ACD non-ASAI adjunct-controlled split applications. Assign AAS only to ACD hunt groups. When all lines in a vector-controlled AAS split are logged out, the split is considered unavailable, and vector processing skips the step in the vector for new calls.

If RONA occurs on the last VRU port in an AAS split, the call is not requeued to the converse split, but is processed by the next vector step.

Any calls queued to a split that has been taken out of service may be left at this split. When the system reinitializes, all busied-out ports are automatically logged back into the AAS splits. New calls cause a RONA timeout if the adjunct or agent still does not answer after the system reinitializes.

- Abandoned Call Search

Abandoned Call Search, if defined for a trunk, is reapplied to call on that trunk that RONA requeued whenever the calls are routed to another agent.

- Agents in multiple splits

When a RONA timeout occurs, an ACD split agent is placed in AUX work mode with notification to CMS for all splits that the agent is logged into. The agent is responsible for becoming available in each split. In an AAS, agents are logged out of all splits that they are logged into. You must log agents back into the AAS splits.

- Agent logout

An agent can log out from a multifunction set while an ACD call subject to RONA is ringing the set. However, if the agent logs out before RONA times out, RONA timing is canceled, and RONA redirection and notification occur immediately.

- Agent work modes

If an agent presses the ACW button with an ACD call ringing, the change request is pending. If the agent has a pending change to ACW before a RONA timeout occurs on a ringing ACD call, RONA timing continues. At timeout, the call is redirected, CMS is notified, and the agent is placed in AUX work (overriding the pending ACW request).

If an agent presses the AUX-Work button with an ACD call ringing, the change request is pending. With ACD splits, since the RONA time-out changes the state to AUX-Work, there is no conflict with the pending AUX-Work change request. With AAS splits, an agent-initiated AUX-Work change is denied per existing operation.

- ASAI

RONA applies to vector-processed calls that are routed by an adjunct to an ACD split or agent as a Direct Agent Call.

You can assign RONA to ASAI adjunct-monitored splits and adjunct-monitored calls. An event report is not sent to the ASAI adjunct when a RONA timeout puts an agent into AUX work mode.

The adjunct makes an agent query (as part of the value query capability group) to determine the agent's state. Once the call is queued to the split, the adjunct receives a call-queued event report if event reporting is active for the domain (VDN or nonvector-controlled split).

An adjunct-monitored split can be assigned as an auto-available split. The logout event for an AAS split is sent to the adjunct when RONA timeout logs an agent out.

You cannot assign RONA to an adjunct-controlled split. An adjunct-controlled split cannot be an AAS.

ASAI CONVERSANT VRU applications are configured with nonvector-controlled splits using manual-answer operation on analog lines to CONVERSANT ports. The ASAI link provides event notification for the ACD split for enhanced services. In addition, you can log in and log out the ports as required. (AAS splits are not used for this application because the ASAI link controls the login or logout).

You can assign RONA to these splits to detect failure conditions in the same manner as non-ASAI VRU applications. RONA does not notify CONVERSANT of AUX work mode changes. ASAI CONVERSANT cannot query to determine the states of its ports. You must restore ports manually after a failure via CONVERSANT management screens. Complete failure is automatically restored when CONVERSANT reinitializes. [Table 9-14](#) describes ASAI events that the switch sends the adjunct for various stages of the RONA call. Also included are the ASAI associations (assuming that they are active) for which the events are provided. For the split to have Notification association active, the split must not be vector-controlled or adjunct-controlled.



Table 9-14. RONA/ASAI Events

| Stage of Call                                  | ASAI Event   | ASAI Associations  |
|--|--|--|
| 1. RONA timeout                                | Logout (for AAS)   | Domain (agent) control   |
| 2. Call redirected to split                    | Call redirected  | Domain (station) control (for agent ext call is leaving)                                       |
|  | Call queued (only if the call queues)  | Domain (station) control, (for new agent & for internal originator) call control, notification |
| 3. Call redirected to VDN processing           | Call redirected  | Domain (station) control (for agent ext that call is leaving)                                  |
|  | Call redirected (only if call is redirected to a VDN with Notification active) | Notification   |
|  | Call offered to Domain   | Notification (VDN)   |
| 4. Call delivered to agent                     | Alerting   | Domain (station) control, (for new agent & for internal originator) call control, notification |
| 5. Call routed to split's coverage path        | Call redirected followed by existing operation of ASAI Events                  | Domain (station) control (for agent ext that call is leaving)                                  |
| 6. Infinite feedback to caller                 | Call redirected  | Domain (station) control (for agent ext that call is leaving)                                  |
| 7. Continue vector processing                  | Call redirected followed by existing ASAI events                               | Domain (station) control (for agent ext that call is leaving redirecting to VDN)               |
| 8. Call routed to direct agent's coverage path | Call redirected followed by existing operation of ASAI events                  | Domain (station) control (for agent ext that call is leaving)                                  |

When a call is redirected via ASAI Redirect Call, the RONA timer is canceled.

- Attendant return call

If an attendant extends a call to an ACD split or VDN for which the return call timer is not activated, the call does not interact with RONA. The Attendant Return Call Timer is not set if an attendant extends the call to another attendant.

- AUDIX Transfer

RONA applies to a call transferred by AUDIX to an ACD split.

A redirected call to AUDIX does not go to split or agent coverage after it is transferred out of AUDIX. If RONA times out on this type of call, the call cannot be redirected.

- Automatic answering

If an agent with automatic answering receives a call with zip tone instead of ringing, RONA timing is canceled.

- Call Coverage

Direct Agent calls are redirected to the agent's coverage path if a path is administered. A temporary bridged call appearance is not maintained for a call directed to an ACD hunt group or VDN, or for a Direct Agent call.

When a call is redirected to an ACD split or direct agent logical ID as a point in the coverage path via Expert Agent Selection (EAS), the Coverage Subsequent Redirection/CFWD No Answer timer is started on the call.

Covered calls go to the next point in the split's coverage path.

If no other point is available to accept the call, the call remains queued or continues to ring the current coverage point. When RONA times out at the coverage point, the following occurs:

- RONA does not reset the Subsequent Redirection/CFWD No Answer timer. The timer that expires first controls the call.
- If the coverage point for a covered call is a direct agent logical agent ID whose split has RONA, and if RONA times out first, the call is sent to the next point in the split's coverage path, not to the agent's coverage path. The Subsequent Redirection/CFWD No Answer timer is reset when the call is redirected to the next coverage point.
- If RONA was applied to an ACD call that was a previously redirected coverage call (that is, the RONA split was a point in the coverage path), RONA is used to requeue the call as specified for a noncovered call. However, the call is not designed to go to split coverage or forwarding. The Subsequent Redirection/CFWD No Answer timer is reset if RONA requeues the call to the RONA split. Both the RONA timer and Subsequent Redirection/CFWD No Answer timer are reapplied.
- If RONA applies to an ACD call that was a previously-redrafted coverage call (for example, the RONA split was the second point in the coverage path), the call is redirected to the next coverage point in the principal's coverage path if the call cannot be requeued to the RONA split. The Subsequent Redirection/CFWD No Answer timer is reset.

- If no other point in the coverage path exists or other points are unavailable, the split-covered call that cannot be requeued or the direct-agent-covered call receives call-cannot-be-redirection handling.

- Call Detail Recording (CDR)

When an agent is assigned to be recorded on the CDR record as the called number, the RONA redirected-to answering destination is recorded as the final called number. You can administer CDR to record the VDN, the hunt group, or the answering agent as the called number.

- Call Forwarding All

If an adjunct Direct Agent call is made to an agent's extension that has Call Forwarding All assigned and it is redirected by RONA, the call follows the agent's coverage path.

A call forwarded via Call Forwarding to a split or logical agent ID with RONA is sent to the principal's coverage path instead of going to the split's coverage path (if the call cannot be requeued) or to the agent's coverage path (for a Direct Agent call) on RONA redirection.

- Call Pickup

A member of an agent's pickup group can pick up an ACD call that is being timed for RONA. RONA is cancelled.

- Call Vectoring

RONA applies to vector-controlled ACD splits when calls are queued via the *queue-to main split*, or *converse-on split*, or *check-backup split* commands. Also, RONA applies to nonvector-controlled and vector-controlled ACD splits when calls are routed to the split via a *route-to* or a *messaging split* command. Basic Call Vectoring handles an AAS with all agents logged out as unavailable and skips the relevant step, just as it does for a split with all queue slots busy. With an *adjunct routing* or *route-to with coverage* step that routes to a vector-controlled split with all agents logged out, the call is given a busy tone just as when the call cannot queue to a nonvector controlled split according to the existing operation.

Vector events are generated for a RONA timeout when *converse-on* processes a call or results in a RONA redirection failure, and when a vector step is skipped because all AAS agents are logged out.

Do not assign vector-controlled splits coverage, forwarding, or night service, because Call Vectoring provides these functions. These functions do not apply to RONA-redirection calls involving vector-controlled splits.

- Calling/Called Number Display

A call to a split that RONA redirects is similar to a direct call to the split. If the call goes to coverage, the destination display looks like it does for a normal covered call.

9 Call Center

*Redirection on No Answer*

Page 9-126

An internal or DCS caller to an ACD hunt group or VDN sees displayed the hunt-group or VDN name and extension. This display remains when the call rings an agent. A Direct Agent call (with EAS) initiated at a voice terminal displays the agent name and logical ID when the call rings the agent's terminal. If the ACD-split or Direct Agent call goes to coverage, the name remains, but the extension or logical ID portion changes to "cover." This also happens when RONA redirects a call.

- Delay announcements

Delay announcements assigned to non-vector-controlled splits are applied to requeued RONA calls as usual for redirected calls.

- Direct Agent Calling

RONA applies to Direct Agent calls from splits with RONA assigned. RONA timing applies when a Direct Agent call (from an adjunct or voice terminal) is delivered to and rings an agent with manual answering. Agents are placed in AUX work mode or logged out even if they are the last agent in the split and ACD split calls are queued. Direct agent calls that are queued for an agent remain queued and are not delivered because the agent is unavailable. Don't-answer (DA) coverage continues for the queued calls.

If an agent with a coverage path is made unavailable by a RONA time-out on a non-covered Direct Agent call, the call follows the agent's coverage path. With EAS, the agent's logical extension coverage path for Direct Agent calls is used. If the agent has no coverage path or if the path is unavailable, the call cannot be redirected and the caller hears previously-provided feedback.

If Direct Agent call comes from a split that has forwarding or night service, the call is forwarded, precluding RONA timing. If the agent has forwarding or Send-All-Calls, the Direct Agent call is forwarded (ACD calls only) or goes to coverage, precluding RONA timing.

- Direct Department Calling

RONA applies to DDC-type hunt-group ACD calls.

- Home Agent

RONA applies to Home Agent lines that terminate on the CONVERSANT Home Agent system as a means to detect port failures. Home Agent lines use Manual Answer and are not present in AAS. Once RONA notification is made, you can correct the failure and restore service manually on CONVERSANT.

- Inbound Call Management (ICM)

RONA applies to ICM-managed calls that ring an agent in an ACD split with RONA assigned.

- Message Center/Server Service

You can assign RONA to Message Center/Server ACD splits.

- Multiple Call Handling (MCH)

If an MCH agent has a call active or on hold and the Redirection on No Answer timer expires for another ringing ACD call, the ringing call is redirected to the split/skill or administered VDN. When the call redirects, the agent is not made unavailable, but is placed in the Most Idle Agent (MIA) queue.

- Music-on-Hold access — Music on Transferred trunk call

Trunk callers who are transferred to another destination continue to hear administered music (or silence), not ringback, while the call rings. This applies while the transferred call queues to a split.

If the trunk call (an ACD call or Direct Agent call) is transferred to a split with RONA, timeout applies to the call, but the caller continues to hear the previous feedback instead of ringback.

- Night Service

When Night Service is activated, calls (including RONA calls) for the hunt group redirect to the night station extension. If the night service split has RONA assigned, RONA timing is reapplied to the redirected call.

- Queue status indications

Calls that RONA requeues are counted in the queued calls total. When a RONA call is queued, the call's call-wait time is reset, so RONA does not affect the oldest call waiting (OCW) time.

- Queuing

When redirected to a split, RONA timed-out ACD calls in a nonvector-controlled split are queued at the highest priority. These calls are distributed before any other calls, except Direct Agent calls.

- Stations

RONA applies to ACD split or direct agent ACD calls that ring at multifunction or hybrid stations with Manual Answering in an ACD hunt group.

RONA applies to Off-Premises Station (OPS) lines in an ACD split.

- Voice Response Integration (VRI)

You can assign RONA to converse splits. RONA timing applies to calls that a *converse-on* command queues and delivers. RONA timing is canceled if a call is delivered to an agent in another split to whom the system previously tried to queue a call.

RONA interacts with a converse split that is an AAS like any other AAS.

If RONA must redirect a call to an agent port in a converse split and the queue is full or all AAS agents are logged out, the call is processed by the next vector step while the caller continues to hear the previous vector feedback.

## Interactions with other ringing call timers

Several features time the ringing when an ACD call is delivered to an agent. You can use RONA's timer in conjunction with other timers.

### NOTE:

The timer that expires first applies to the call. RONA is canceled if any of the other timers expires first, except in the case of coverage timers.

When a coverage timer expires, RONA timing is canceled only when the call goes to coverage. If RONA times out first, the other timers continue timing or are stopped and may later be reset. The timers that may interact with RONA are listed in [Table 9-15](#) and [Table 9-16](#). [Table 9-16](#) indicates what happens to the timer if RONA times out first

**Table 9-15. Timer Description**

| Timer       | Description   |
|-------------|---|
| Split DA    | Split Call Coverage Don't Answer (nonvector-controlled) |
| Covering DA | Covering Point DA - Subsequent Redirection No Answer    |
| Agent DA    | Agent DA Coverage (Direct Agent Calls)                  |
| NATO        | DID/CO Trk No Answer Timeout                            |
| WAST        | Wait Answer Supervision Timer                           |

**Table 9-16. RONA/Timer Interaction**

| Timer       | RONA Timeout | Restarted After Redirection?                     |
|-------------|--------------|--|
| Split DA    | Stopped      | If queued or delivered to another agent          |
| Covering DA | Stopped      | If redirects to covering point                   |
| Agent DA    | Stopped      | If covers to Direct Agent with coverage          |
| NATO        | Continues    | N/A  |
| WAST        | Stopped      | If ringing destination or RONA redirection fails |

If you want RONA notification and redirection, set the number of rings (or equivalent time) for a RONA timeout to shorter than other timeout periods. DA timers start when a call is placed in queue and continue when the call rings the

station. Since RONA starts only when the call is ringing, the RONA interval is usually set to two or three rings, while the DA interval is set to 10 or more rings.

Since queue time is variable, assign a coverage timeout period that is greater than the longest expected queue time plus three or four rings (the time the call could ring the agent).

The NATO timer starts when the call seizes the incoming trunk. The timer could thus be timing before the call is queued by vector processing. Therefore, set the NATO timer to greater than the longest expected time before the call rings the agent (including time before and after being queued) plus three or four rings.

The WAST timer starts when the call rings the agent. Set the RONA timer to a slightly shorter interval (fewer than 10 rings) than the WAST 50-second interval.

## Universal Call ID

---

Universal Call ID (UCID) is a unique tag assigned to a call.

In simple call scenarios, the tag stays with that call within a DEFINITY-based network connected by ISDN lines. In complex call scenarios, the tag often merges with other tags.

### ⇒ NOTE:

The UCID data element is “universal” because it does not just identify a call on one particular DEFINITY switch; a UCID uniquely identifies a call across a network of DEFINITY switches.

## What is UCID’s purpose?

---

The purpose of UCID is to tag a call with a unique identifier.

UCID provides a way to track calls across multiple DEFINITY switches and Voice Response Units (INTUITY CONVERSANT for DEFINITY R6.3).

Call centers can use UCID to track call history. Because UCID can uniquely identify every call in a network of any size, it is possible to track call-related data from multiple sources (DEFINITY and INTUITY CONVERSANT) and multiple sites. For example, you can combine data from many locations and print reports that enable you to track a call throughout its lifecycle. For information about such reports, refer to the CentreVu<sup>®</sup> Call Management System R3V6 Reports manual 585-215-851.

### ⇒ NOTE:

Although UCID is intended for call centers, a DEFINITY ECS configured to create UCIDs will assign one to *every* call—not just to Automatic Call Distribution (ACD) calls.

In the near future, a client tool will use UCIDs to present a unified call record.

## What does UCID look like?

---

The Universal Call ID is an 8-byte data element that displays as a 20-character number. It looks something like this:

01035051001071518260

## How Does UCID Work?

---

For every new call that comes into or is originated by a DEFINITY or CONVERSANT product, the product creates a UCID. Depending on the call scenario, the UCID will either remain unique to that call or merge with other UCIDs.



## What creates UCIDs?

Both DEFINITY ECS and CONVERSANT can create UCIDs once the capability has been enabled. In other words, neither product automatically creates UCIDs until the feature is enabled.

## When are UCIDs created?

Once DEFINITY ECS or CONVERSANT is administered to create UCIDs, these products assign a UCID to each call. For incoming calls over ISDN trunks, DEFINITY ECS determines whether or not the call already has a UCID. If so, the switch preserves the existing UCID and does not create a new one. If the call does not have a UCID, the switch creates one when call processing begins. For incoming calls over non-ISDN trunks, DEFINITY ECS creates a UCID for the call because non-ISDN trunks do not support the transmission of UCID.

For outgoing calls, DEFINITY ECS creates a UCID when the caller goes off-hook.

## How are UCIDs transmitted?

How DEFINITY ECS transmits UCIDs depends on the sending and receiving equipment. See [Table 9-17](#) for an overview.

**Table 9-17. UCID Transmission**

| Sender             | Receiver           | Connection   | UCID contained in  |
|--------------------|--------------------|--|--|
| DEFINITY ECS       | DEFINITY ECS       | ISDN (BRI or PRI) trunks using QSIG service protocol       | codeset 0 Facility IE as manufacturer specific information (MSI) IE <sup>1</sup> |
| DEFINITY ECS       | DEFINITY ECS       | ISDN (BRI or PRI) trunks using Shared UUI service protocol | codeset 0 shared user-to-user information (UUI) IE <sup>1</sup>                  |
| DEFINITY ECS       | INTUITY CONVERSANT | ASAI   | various ASAI messages  |
| INTUITY CONVERSANT | DEFINITY ECS       | ISDN-PRI   | codeset 0 shared UUI IE <sup>1</sup>   |
| DEFINITY ECS       | CentreVu CMS       | BX.25  | SETUP5 CMS message   |
| DEFINITY ECS       | CTI adjunct        | ASAI   | various ASAI messages  |

1. Refer to [Information Forwarding](#) section.

## How are UCIDs tracked?

---

The way a network maintains and tracks a UCID depends on the call path. To illustrate UCID transport throughout a call's life cycle, this section describes several call scenarios:

- Station-to-station Calls
- Incoming Trunk Calls
- Outgoing Trunk Calls
- Simple Transfer or Conference
- Complex Transfer *and* Conference

### Station-to-Station Calls

This scenario describes what happens when Phone I calls Phone II (both phones are on the same switch).

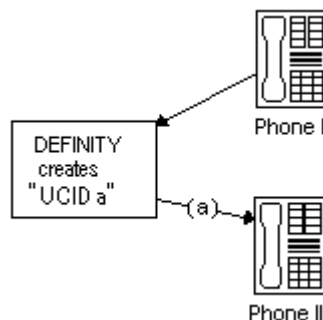

DEFINITY creates a new UCID (such as UCID "a") for any call originated by an internal station user.

## Incoming Trunk Calls

UCID is assigned to an incoming call.

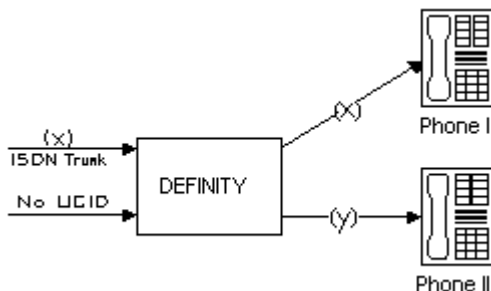

DEFINITY either

- receives UCID “x” information from an incoming call over an ISDN trunk.
- creates UCID “y” for incoming calls that do not already have a UCID.

There is one CMS call history record for each incoming call.

## Outgoing Trunk Calls

UCID is associated with the outgoing trunk call from Phone I.

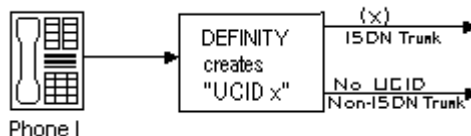

DEFINITY creates a UCID (such as UCID “x”) for an outgoing trunk call and then sends it over an outgoing shared UUI or QSIG ISDN trunk.

DEFINITY creates a UCID (such as UCID “x”) for an outgoing trunk call even if the trunk (such as a non-ISDN trunk) does not support the transmission of a UCID.

## Simple Transfer or Conference

This scenario describes a simple transfer or conference call scenario.

When an incoming trunk or station call is received by the station user at Phone I and transferred to or conferenced with another station user or outside party:

1. DEFINITY creates a UCID for the incoming call if it needs one.

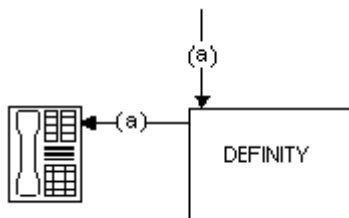

2. DEFINITY creates a new UCID for the temporary conference or transfer portion of the call.

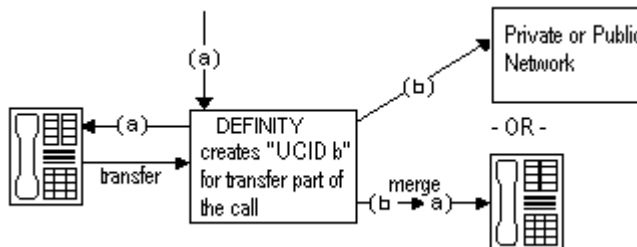

3. DEFINITY merges the temporary portion of the call with the original call when the conference or transfer is completed within the DEFINITY switch. This is when the overriding UCID (such as UCID "a"), becomes the UCID for all parties within the DEFINITY.

**⇒ NOTE:**

If the outgoing trunk does not support the sending of UCIDs, then the UCID of the outgoing call at the receiving switch will be "null".

If the call is transferred to another switch, only the UCID for the transfer (UCID "b") gets passed on. This is because the DEFINITY cannot merge UCIDs if the call is not completed within the switch.

**⇒ NOTE:**

If, during the conference or transfer, the incoming call drops before the operation is complete, the two UCIDs will not appear to be associated because no merge of the two parts of the call was done.

### Complex Conference

The following complex call scenario illustrates when a station user adds an incoming call to an existing conference.

In this scenario,

1. Phones I, II, and III are in the same conference call with UCID "x".
2. The person at Phone III receives an incoming call from Phone IV (this call has UCID "y" associated with it).

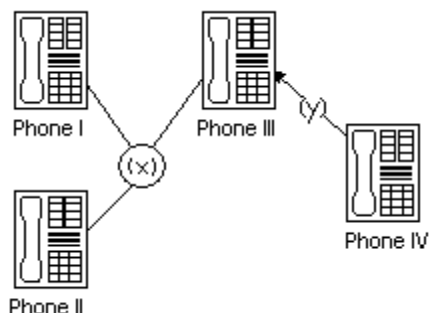

3. The person at Phone III puts the conference call on hold and answers the incoming call from Phone IV.
4. The person at Phone III decides to add Phone IV into the conference call.
5. The person at Phone III
  - a. presses the Conference button
  - b. presses the call appearance button to return to the conference call
  - c. presses the Conference button again.

This brings the conference call into the call between Phones III and IV.

6. UCID "y" overrides UCID "x" because the DEFINITY views Phone IV as the primary party in the conference initiated by step 5.

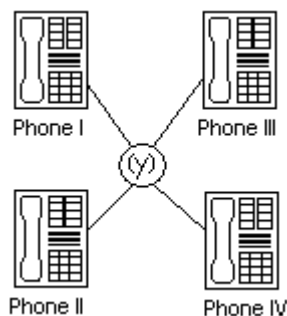

7. The UCIDs associated with each segment of the complex conference are sent to CMS if the parties in the call are measured (for this example, if the parties are ACD agents in a measured split/skill).

## DEFINITY before INTUITY CONVERSANT

The following scenarios describe what happens to UCID information when a call comes in to DEFINITY before it goes to INTUITY CONVERSANT. In this configuration, the INTUITY CONVERSANT serves as a Voice-Response Unit (VRU) that controls the routing of incoming ACD calls.

### ⇒ NOTE:

This configuration is more common than a call coming in to INTUITY CONVERSANT before reaching DEFINITY.

This section describes two scenarios:

- Simple call tracking
- CONVERSANT transfers a call

### Simple call tracking

The following call scenario describes when a call comes in to DEFINITY before INTUITY CONVERSANT.

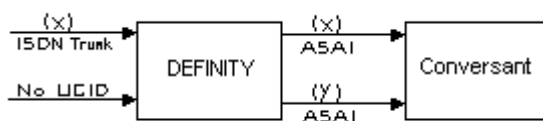

When DEFINITY is before INTUITY CONVERSANT:

1. DEFINITY ECS receives an incoming call over an ISDN trunk.
2. DEFINITY does one of two things:
  - If the incoming call has a UCID (such as UCID “x”), then DEFINITY passes it along.
  - If the incoming call does not have an associated UCID, DEFINITY creates a new one (such as UCID “y”).
3. DEFINITY passes the UCID to INTUITY CONVERSANT through an ASAI connection (via the activation of split/skill or VDN “event notification” by the INTUITY CONVERSANT).
4. UCID information is sent to CMS if trunk, VDN(s), and/or split/skill(s) involved in the call are measured.

### INTUITY CONVERSANT Transfers a Call

The following call scenario involves a CONVERSANT behind DEFINITY configuration when CONVERSANT initiates a call transfer after the call is answered by a port on the INTUITY CONVERSANT that serves as an ACD agent.

1. Call is directed to INTUITY CONVERSANT VRU port (typically by call vectoring) with UCID information (UCID "x" or UCID "y").

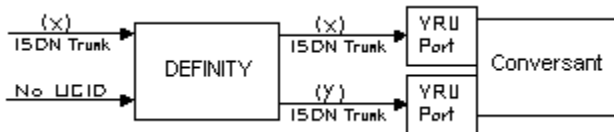

2. INTUITY CONVERSANT determines the call's destination and transfers the call (via an ASAI "third-party transfer" operation).

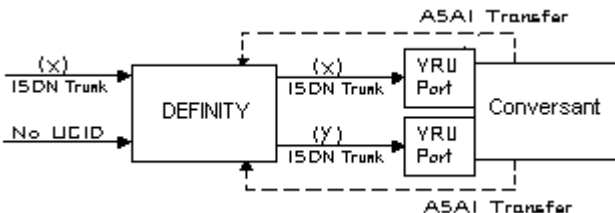

3. DEFINITY ECS temporarily creates a new UCID (such as UCID "a" or UCID "b") for the transfer portion of the call (the original UCID is quickly merged into the call).

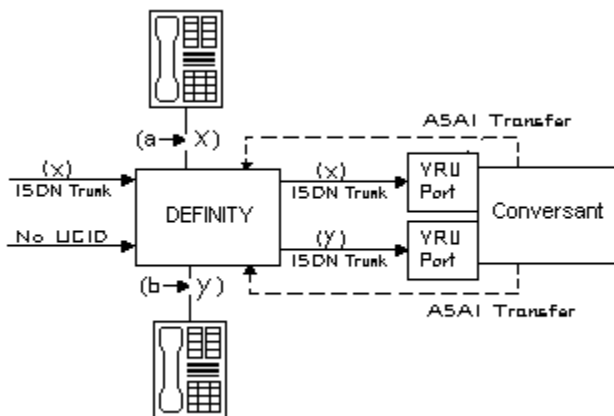

4. The UCIDs of the transfer segment and merged call are returned to INTUITY CONVERSANT in ASAI acknowledgment messages.

- DEFINITY sends UCID information to CMS if trunk, VDN(s), and/or split/skill(s) involved in the call are measured.

### INTUITY CONVERSANT before DEFINITY

This scenario illustrates a system configuration where a call comes in to INTUITY CONVERSANT before reaching DEFINITY. In this configuration, INTUITY CONVERSANT provides voice response services and/or call screening so that the number of incoming calls to the DEFINITY ECS is reduced.

**⇒ NOTE:**

This configuration is less common than the DEFINITY before INTUITY CONVERSANT configuration.

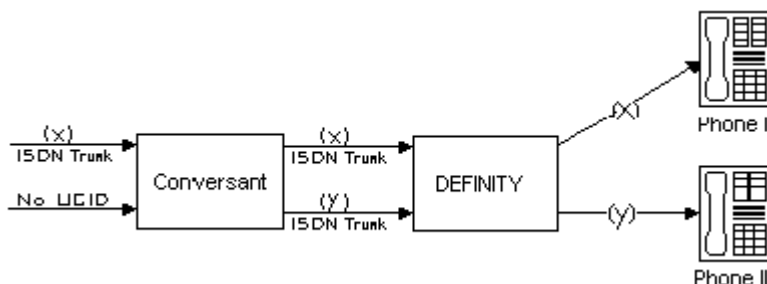

### When INTUITY CONVERSANT is before DEFINITY

- INTUITY CONVERSANT receives an incoming call with UCID "x".

or

INTUITY CONVERSANT creates a new UCID "y" and associates it with the incoming call (if the call has no UCID already associated with it).

**⇒ NOTE:**

For INTUITY CONVERSANT to recognize an incoming UCID (such as UCID "x") from an ISDN trunk, special INTUITY CONVERSANT scripting is required. When INTUITY CONVERSANT receives a call from the public network, it automatically creates a new UCID because it cannot recognize whether or not the call already has a UCID.

- INTUITY CONVERSANT sends UCID to DEFINITY ECS over an ISDN-PRI trunk.
- DEFINITY receives UCID and reuses it for the incoming call.
- DEFINITY reports UCID to CMS if the trunks, VDNs, and/or splits/skills associated with the call are measured.



## Interactions

---

- Distributed Communications System (DCS)
 

If DCS is used in a network of DEFINITY switches where UCIDs are tracked, the DCS feature must be configured with ISDN trunks having the Shared UUI service protocol. Otherwise, calls that are handled through one of the many DCS features (such as DCS Coverage) will not retain the UCID initially assigned to the call.
- Remote AUDIX
 

For remote AUDIX over DCS, the DCS trunk(s) used to accomplish the remote AUDIX operation must be configured (as described previously in “Distributed Communications System”) to retain the UCID associated with a call.
- Tandem Calls
 

When a call is tandemed through a DEFINITY ECS switch, the UCID information may be blocked or passed through the tandem switch. To pass a UCID through a tandem switch, both the incoming and outgoing trunks at the tandem switch must be configured to handle UCIDs. See [“Information Forwarding” on page 9-89](#) for proper private and public network information forwarding administration.

## Before You Start

---

Before you start to administer the UCID feature, be aware that UCIDs are successfully transmitted *only* when all DEFINITY network components meet the requirements (software and connections) specified below.

Some requirements vary, depending on how you want to use UCID. [Table 9-18](#) shows the requirements for different applications of UCID.

**Table 9-18. Requirements for UCID Applications**

| What do you want to do?                     | Your system must meet the following <b>software</b> requirements... | Your system must have the following <b>connections</b> ...     |
|---|---|--|
| Have DEFINITY create UCIDs                  | DEFINITY R6.3 or later  |  |
| Have DEFINITY send UCID to another DEFINITY | DEFINITY R6.3 or later  | ISDN (BRI/PRI) trunks with Shared UUI or QSIG service protocol |
| Have DEFINITY send UCID to CONVERSANT       | DEFINITY R6.3 or later<br>CONVERSANT 7.0 or later                   | ASA link to CONVERSANT   |

**Table 9-18. Requirements for UCID Applications**

| What do you want to do?                       | Your system must meet the following <b>software</b> requirements...   | Your system must have the following <b>connections</b> ...          |
|---|---|---|
| Have DEFINITY receive UCID from CONVERSANT    | DEFINITY R6.3 or later<br>CONVERSANT 7.0 or later   | ISDN-PRI connection (with shared UUI) between switch and CONVERSANT |
| Have DEFINITY send UCIDs to CMS               | DEFINITY R6.3 or later<br>CMS R3V6 or later   | BX.25 connection from switch to CMS                                 |
| Have DEFINITY send UCIDs to a CTI Application | DEFINITY R6.3 or later<br>T-Server R3.1.0 or later<br>DEFINITY PBX Driver (G3PD)- R3.1.0 or later<br>CallVisor PC V6 or later | ASAI link to adjunct  |

 **NOTE:**

You can check your software version numbers by typing **list config software** at the SAT terminal. Because “V6” (version 6) includes 6.1 through 6.3, you may have to check that your network has the separate 6.3 upgrade (this is the earliest DEFINITY version to support UCID).

To maximize the benefits of UCID, it is recommended that all switches be configured with DEFINITY R6.3 (or later) software. However, because upgrading a network is often a gradual process, there may be a switch that cannot yet support UCIDs. In this environment, disallow the UCID transmission for any trunk group connected to a pre-DEFINITY R6.3 switch. For information about enabling or disabling UCID transmission on a trunk group, see “How to Administer Universal Call ID” later in this chapter.

In the case of a DEFINITY network component that cannot support UCIDs, it is recommended that the component (ISDN trunk group, ASAI connection, or CMS software) be administered to disallow the sending or receiving of UCID. For example, if a DEFINITY R6.3 is connected to a non-Lucent Technologies PBX, then the connecting ISDN trunk must be administered to not send UCID over that trunk for outgoing calls.

**How to Administer Universal Call ID**

These instructions assume you’re using the SAT (Subscriber Access Terminal) screen or a terminal emulator to access the DEFINITY software.

There are three tasks involved in administering UCID on DEFINITY ECS. Complete these tasks in the following order:

- Task a. Check ASAI Interface before enabling UCID
- Task b. Set DEFINITY ECS to create and send UCIDs
- Task c. Enable UCID Transmission on Trunk Groups

### Task a: Check ASAI Interface before enabling UCID

If this procedure is not performed, you may encounter the “ASAI Interface feature not assigned” error message in later steps.

**Table 9-19. Form Needed to Check ASAI Interface**

| Form needed       | Field needed?  | Why is this field needed?            | Is field optional? | Page                  |
|-------------------|----------------|--------------------------------------|--------------------|-----------------------|
| Optional Features | ASAI Interface | Global setting to send UCIDs to ASAI | Y                  | <a href="#">5-277</a> |

To check the ASAI interface:

1. In the command line, enter **change system-parameters customer-options** and press RETURN.
2. On page 1, enter **y** in the *ASAI Interface* field.
3. Log out and log back in if this and any other fields in this form have changed.

## Task b: Set DEFINITY ECS to create and send UCIDs

You must administer each DEFINITY switch that you want to create UCIDs. If you do not administer a switch, it will pass along an already-created UCID, but it won't create one if a call comes to it first.

**Table 9-20. Forms Needed for DEFINITY to Create and Send UCID**

| Form needed                       | Fields needed                    | Why is this field needed?                        | Is field optional? | Page                  |
|-----------------------------------|----------------------------------|--|--------------------|-----------------------|
| Feature-Related System Parameters | Create Universal Call ID (UCID)? | To generate a UCID for each call when necessary. | N                  | <a href="#">5-133</a> |
|                                   | UCID Network Node ID             | Important component of the UCID tag.             | N                  | <a href="#">5-133</a> |
|                                   | Send UCID to ASAI?               | So that ASAI receives UCIDs.                     | Y                  | <a href="#">5-141</a> |
|                                   | Adjunct CMS Release              | So that CMS receives UCIDs.                      | Y                  | <a href="#">5-145</a> |

For DEFINITY to create and send UCIDs:

1. If your network includes CMS and you want CMS to track UCIDs, then enter **busyout mis** in the command line. If not, go to step 2.
2. In the command line, enter **change system-parameters feature** and press RETURN.  
The Feature-Related System Parameters form comes up.
3. Go to page 4 of the form.
4. In the Create Universal Call ID (UCID)? field, enter **y**.
5. In the UCID Network Node ID field, enter the node ID number.

Valid numbers are from 1 to 32,767.



### CAUTION:

*The UCID Network Node ID **must** be unique for every DEFINITY and CONVERSANT in the system. If it is not unique, the integrity of the UCID is compromised.*

6. If your network includes ASAI, go to page 7 of the form. If not, go to step 8.
7. In the Send UCID to ASAI? field, enter **y**.

8. If you have performed the **busyout mis** command, go to step 9. If not, you are done with this task (Task b), so press **(ENTER)** to save your work and go to Task c.
9. Go to page 8 of the form.
10. In the `Adjunct CMS Release` field, enter **R3V6**.
11. Press **(ENTER)** to save your work.
12. In the command line, enter **release mis**.

### Task c: Enable UCID Transmission on Trunk Groups

When you send UCIDs over ISDN trunks, it is administered on a trunk group basis. [Table 9-21](#) provides the form and field information that you need to perform this task.

**Table 9-21. Enabling UCID transmission on trunk groups**

| Form needed | Fields needed                  | Why is this field needed?  | Is field optional? | Page                  |
|-------------|--------------------------------|--|--------------------|-----------------------|
| Trunk Group | Group Type                     | To specify correct trunk type: ISDN is the only type that supports UCID. | N                  | <a href="#">7-202</a> |
|             | Supplementary Service Protocol | Specify correct service type. <b>b</b> is for QSIG, others are for UUI.  | N                  | <a href="#">7-202</a> |
|             | Send UCID?                     | Allows or blocks UCID transmission.                                      | N                  | <a href="#">7-208</a> |

To enable UCID transmission on a trunk group:

1. In the command line, enter **change trunk-group n** and press RETURN.  
The Trunk Group administration form comes up. *n* is the number of the trunk group you want to administer.
2. On page 1, enter **ISDN** in the Group Type field.
3. In the `Supplementary Service Protocol` field, enter the letter of the service protocol you want for this trunk group.  
**b** is for QSIG, other protocols are for UUI.
4. Go to page 2 of the form.
5. In the `Send UCID?` field, enter **y**.
6. Press **(ENTER)** to save your changes.

You also need to administer your trunk groups to send user data over your private and public networks. To administer the trunk groups, see [“Information Forwarding” on page 9-89](#).

## Considerations

---

- UCID has been tested with several major carriers. To find out if these capabilities work with your carrier, check with your account team for the most current information. If testing has not been done to verify operation over the public networks involved with the preferred specific configuration, use of private ISDN trunking between the nodes should be assumed until successful testing has been completed.

## Troubleshooting

---

The following troubleshooting hints should be reviewed when UCIDs are not transmitted, even though you received no error messages while administering the UCID feature, and all software and connections meet the minimum requirements:

- A tandem switch has the `Send UCID?` option set to **y** for all trunk groups that AAR/ARS or station users may use to tandem an incoming call.
- If DCS is used, make sure *all* ISDN trunks between DEFINITY switches used for DCS or remote AUDIX are configured in the D-channel mode.
- For CMS tracking purposes, make sure all trunks, VDN, and split/skills that handle calls for which UCIDs are tracked are administered as “measured” (either “both” or “external”).

## VDN in a Coverage Path

---

VDN in a Coverage Path (VICP) enhances Call Coverage and Call Vectoring to allow you to assign Vector Directory Numbers (VDNs) as the last point in coverage paths. Calls that go to coverage can be processed by vectoring/prompting to extend Call Coverage treatments.

### How to administer VICP

---

#### Required Forms

---

| Form                    | Field | Page                  |
|-------------------------|-------|-----------------------|
| Coverage Paths          | ■ All | <a href="#">5-94</a>  |
| Call Vector             | ■ All | <a href="#">9-207</a> |
| Vector Directory Number | ■ All | <a href="#">9-214</a> |

- Call Coverage Path form — Set one of the following to the extension of the VDN to be used as a coverage point: Point 1, Point 2, Point 3, Point 4, Point 5, Point 6.

### Considerations

---

A VDN is not allowed as a member of a coverage answer group. A vector cannot route a covered call to a coverage answer group — a coverage answer group can only be a point in a coverage path.

Removing a VDN from the system with the *remove vdn <extension>* command automatically removes the VDN from any coverage paths.

### Interactions

---

None

## VDN of Origin Announcement

---

VDN of Origin Announcement (VOA) provides agents with a short message about a caller's city of origin or requested service based on the VDN used to process the call.

Use VOA messages to help agents to respond appropriately to callers. For example, if you have two 800 numbers, one for placing orders and one for technical support, you can administer two VDNs to route calls to the same set of agents. When an incoming call is routed to a VDN with a VOA assigned (for example, "new order" or "tech help"), the VDN routes the call to a vector, which can place the call in an agent queue. When an agent answers the call, he or she hears the VOA message and can respond appropriately to the caller's request.

### How to administer VOA

---

#### Required forms

| Form                              | Field   | Page                  |
|-----------------------------------|---|-----------------------|
| Attendant Console                 | <ul style="list-style-type: none"> <li>■ Feature Button Assignments — VOA Repeat</li> </ul> | <a href="#">5-35</a>  |
| Class of Restriction (COR)        | <ul style="list-style-type: none"> <li>■ VDN of Origin Announcements</li> </ul>             | <a href="#">5-72</a>  |
| Feature-Related System Parameters | <ul style="list-style-type: none"> <li>■ Hear Zip Tone Following VOA?</li> </ul>            | <a href="#">5-123</a> |
| Announcements/Audio Sources       | <ul style="list-style-type: none"> <li>■ All</li> </ul>                                     | <a href="#">5-26</a>  |
| Vector Directory Number           | <ul style="list-style-type: none"> <li>■ VDN of Origin Annc. Extension</li> </ul>           | <a href="#">9-214</a> |
| Voice Terminals                   | <ul style="list-style-type: none"> <li>■ Feature Button Assignments — VOA Repeat</li> </ul> | <a href="#">6-4</a>   |

- Announcements/Audio Sources — Assign each VOA you want to use. You can administer aux-trunk types with queue, without queue, and with barge-in. You can administer integrated types with queue and without queue. Do not administer analog and integrated repeating announcement types as VOAs.

The VDN for which you are administering a VOA must be in a vector command line.

### Detailed description

---

The agent cannot hear the caller while the VOA message is playing. The caller is not connected to the agent until after the message completes and cannot hear the message or the agent during the message. The caller hears ringback while the agent is listening to the VOA.



Agents logged in at multiline terminals see the call-appearance button for an incoming call flash until after the VOA completes. An agent can press the flashing call-appearance button to stop the VOA.

To repeat the VOA, an agent presses the VOA Repeat button. The VOA Repeat button lamp lights during the VOA. The VOA Repeat button lamp remains lit if the repeat request is queued. If an agent presses the VOA Repeat button while the lamp is lit, the VOA is stopped. If an agent presses the VOA Repeat button but there is no VOA or the system cannot play the VOA within three seconds, the lamp flutters.

You assign VOAs for each VDN. However, the VOA applies to a COR, so you must administer a COR for agents who will receive VOAs.

You can set up VOAs in four ways:

- Agents can hear a unique announcement based on the dialed number identification service (DNIS) received from the service office or carrier switch. Assign each DNIS as the VDN of a vector. Set up the VOA to announce the services associated with the DNIS.

 **NOTE:**

The announcement associated with the current VDN only plays if the VDN Override for the previous VDN is set to y. If VDN Override for the previous VDN is set to n, the VOA associated with that VDN plays.

- Use vector steps, an integrated prompting, or *converse-on* step to route calls to a VDN. Set up the VOA to announce the service the caller requested or to announce a condition that caused the call to *route-to* the VDN.
- You can route calls to a voice response system, directly or through a vector. Use voice prompting to direct the caller to enter a touchtone response, and route the call to a specific VDN based on the caller's response. Set up the VOA to indicate the service the caller selected.
- If agents require a caller's city of origin, assign the trunk group to a particular VDN. Set up the VOA to provide the location of the origin of the trunk group. Subsequent VDNs can be used to handle the call, or multiple VDNs can be assigned to a single vector.

 **NOTE:**

VDN Override applies to VOA in the same way that VDN Override applies to display information. If a VDN with a VOA has VDN Override enabled, the system overrides the original VOA with VOAs in subsequent VDNs to which the call is routed.

## Considerations

---

- Because callers are kept waiting while a VOA plays, messages should be kept very brief — no more than 1.5 seconds in length. Agents should use a speakerphone or headset, so they do not miss the VOA while they are picking up the handset. If agents cannot use a speakerphone or headset, administer voice terminals with a VOA Repeat button.
- If you have multiple announcement boards, you should place shorter VOAs on one board and longer recorded announcements on the other to avoid delaying delivery of VOAs. If you have only one announcement board, place VOAs on the integrated board and consider installing an auxiliary announcement device for longer announcements.
- Agents must be on the same switch as the VOA.
- A VOA can be assigned to multiple VDNs, but a VDN can have only one VOA.
- If you use the TN750 circuit board for integrated announcements, the system maintains a separate logical queue for VOAs. If the VOA cannot be delivered to the agent within 1 second because of traffic or inoperative equipment, the system does not provide the announcement. VOAs are higher priority than other announcements on the TN750. A burst of VOAs can delay other announcements. Therefore, record non-VDN of Origin Announcements as auxiliary or analog.
- Auxiliary announcements are connected for a duration of 1 to 2 seconds on a barge-in basis, immediately after the agent answers (or is assigned the call for auto-answer) and the incoming call is extended to the agent. Integrated and non-barge-in auxiliary announcements are connected for the duration of the announcement. The switch does not ensure that the integrated announcement is shorter than the allowed playback time.
- VOA supports Auxiliary Trunks (aux-trunk) with barge-in, queue, or without queue. For aux-trunk with or without queue, when the trunk is idle, a VDN call seizes the trunk to start the VOA and the system plays the entire announcement (not just 1 to 2 seconds). However, if the announcement is busy and if aux-trunk has barge-in, the call does not queue but bridges onto the announcement for 1 to 2 seconds. When the VOA completes, the trunk is released along with the listeners, and the next call requiring the VOA starts the process over again. For this reason, your aux-trunk announcements should consist of one short announcement that repeats during the full announcement time. For example, you might want to record “New Order” as many times as possible, so that when a call bridges to the announcement, the agent hears “New Order” no matter where the agent bridges into the announcement.
- If you use aux-trunk or integrated announcement without queue and a port is busy when a VDN call comes in, the system cannot play an announcement. If you use aux-trunk or integrated announcement with queue, the system plays the current announcement for an agent and then connects the next agent in the queue.

## Interactions

---

- Agent Call Handling (Answering Options)
  - Automatic Answer

ACD agents at voice terminals in Auto Answer mode hear a zip tone, then the VOA. You can also administer a zip tone after the VOA completes, to alert agents that an announcement is complete and a caller is connected.

Non-ACD agents can receive a VOA if a call is routed to them via vector processing. When non-ACD agents at voice terminals in Automatic Answer mode receive calls, they hear a call ID tone then the VOA. Agents hear a second zip tone after the VOA indicating connection to the caller.
  - Manual Answer

When non-ACD agents at voice terminals in Manual Answer mode receive calls they hear ringing, answer the call, and hear the VOA.
- ASAI Adjunct Routing

If a vector step includes Adjunct Routing, the VOA is played for the agent to whom the call is routed.
- Auto-Available Split (AAS)

AAS is intended to be used for splits containing only nonhuman adjuncts such as AUDIX or Conversant; however, VOAs can be directed to Auto-Available splits.
- Call Forwarding

VOAs apply to forwarded calls, including those forwarded to a hunt group. The answering station must be on the same switch. If a VOA is forwarded, the message is played only if the destination extension is administered with a COR that allows VOA.
- Call Pickup

Call Pickup allows an agent to pick up a ringing call on another extension. If the pick-up extension has COR permissions for VOA, the agent can receive a VOA.
- Conference

If an agent receives a call and then conferences in additional stations, any station on the connection can use VOA Repeat button to replay the VOA. Only the person using the button can hear the VOA unless the call is being service observed.

- Converse-on split

A converse-on split is one used in a *converse-on* vector step. When a *converse-on* vector step is executed, a VOA is not applied. After returning to the vector, the call can be routed to a station or VDN where the answering agent receives the VOA (as if the *converse-on* step had not been processed).

- Coverage

VOA applies to coverage paths.

- Data Restriction

Data Restriction prevents tones from being applied to line or trunk circuits during a data call. VOAs are not played for data-restricted calls.

- Direct Agent Calling

Direct Agent Calling allows a vector to route a call to particular ACD agent and have the call treated as an ACD call. The VOA only applies to direct agent calls if the calls reach an agent through vector processing. Direct agent calls from a voice terminal on a switch are not vector-processed and cannot cause a VOA to be played.

- Enhanced Automatic Wake-up

If you are using enhancements to Automatic Wake-up with integrated announcements, there can be contention for integrated announcement ports. VOAs have priority over Automatic Wake-Up announcements.

- Expert Agent Selection (EAS)

When you are using EAS, the logical agent COR definition determines the assignment of VOAs for each extension. EAS uses the COR of the logical agent instead of the COR for the terminal being used by the agent.

- Hold

Agents cannot use the VOA Repeat button if their calls are all on hold. The VOA Repeat button only applies to active calls.

- Home Agent

You can assign an initial VOA to a home-agent port on the switch. However, home agents cannot use a VOA Repeat button because home agents need a dial access code (DAC) to reach features and VOA replay does not use a DAC.

- Hunt Groups

VOAs apply to calls routed to a hunt group. The COR for the answering station's extension determines whether the station can receive a VOA.

- Lookahead Interflow

VOAs apply only to the switch where the VDN is defined. If a call interflows to another switch, the VOA is lost. You can have the interflow to another switch access a VDN with the same VOA message as on the original switch.
- Redirection on No Answer (RONA)

If a call re-queues to a split or skill because the RONA timer expired, the VOA applies to the call when an agent answers the call.
- Service Observing

The system handles Service Observing calls as conference connections. If the observer presses the VOA Repeat button only he or she hears the announcement. However, if another party on the call presses the VOA Repeat button, the user and the observer hear the VOA.
- Supervisor Assist

If an agent requests supervisor assistance and conferences the supervisor into a call, either the agent or the supervisor can use their VOA Repeat button to replay the VOA, but only the person who presses the button hears the VOA.
- Transfers

If an agent receives a VDN call and transfers the call, the answering party can use the VOA Repeat button to replay the message.
- VOA distribution

If you use long VOAs or multiple VOAs, there may be a delay between the zip tone and the announcement. The system provides multiple announcement circuit packs to help prevent announcement delays. Contact your Lucent representative for more information.

## Voice Response Integration

---

Voice Response Integration (VRI) integrates Call Vectoring with the capabilities of voice response units (VRUs) such as the Lucent Technologies CONVERSANT Voice Information System (CVIS). With VRI, you can:

- Run a VRU script while retaining control of a call in vector processing
- Run a VRU script while a call is queued, retaining its position in the queue
- Pool CONVERSANT ports for multiple applications
- Use a VRU as a flexible external-announcement device
- Pass data between the system and a VRU
- Tandem VRU data through a switch to an ASAI host

The *converse-on* command, which is part of Basic Call Vectoring, provides these capabilities. Use a *converse-on* call-vector step to integrate a VRU with Automatic Call Distribution (ACD). VRI allows you to use VRU capabilities while controlling a call in ACD.

Include VRUs with vector processing to take advantage of the following:

- Access to local and host databases
- Validation of caller information
- Text-to-speech capabilities
- Speech recognition
- Increased recorded announcement capacity
- Audiotex applications
- Interactive voice-response (IVR) applications
- Transaction-processing applications

VRI allows users to make productive use of queuing time. For example, while a call is queued, a caller can listen to product information via an audiotex application or can complete an interactive voice-response transaction. It may be possible to resolve the caller's questions while the call is queued, which helps reduce queuing time for other callers during peak times.

For more information on VRI and the *converse-on* command, see the *DEFINITY Enterprise Communications Server Release 6 Call Vectoring/Expert Agent Selection (EAS)*.

## How to administer VRI

---

Enable Call Prompting to allow the system to collect digits from the caller and CONVERSANT to return data. You must have Call Prompting to administer the Converse Data Return Code and use the digits keyword for the <data\_1> or <data\_2> fields on the *converse-on* command.

### Required forms

| Form                                  | Field   | Page                  |
|---------------------------------------|---|-----------------------|
| System Parameters<br>Customer-Options | ■ Call Prompting  | <a href="#">5-277</a> |
| Feature Access Code (FAC)             | ■ Converse Data Return Code                                     | <a href="#">5-113</a> |
| Feature-Related System<br>Parameters  | ■ Converse Delay Data1/Data2<br>■ Converse Signaling Tone/Pause | <a href="#">5-123</a> |
| Call Vector                           | ■ All   | <a href="#">9-207</a> |

## Detailed description

---

A call queued to an ACD split retains position in the queue while a VRU script is being run. When an agent becomes available, the line to the VRU is dropped and the caller connects to the agent.

The *converse-on* command delivers a call to a predetermined converse split (skill). A converse split is administered and operates exactly like other splits. Nonconverse splits are ACD splits accessed by *queue-to main* and *check-backup* vector steps.

Members of a converse split are the ports connected to the VRU. If all VRU ports are busy, a call queues to the converse split with the administered priority. After the VRU answers the call, the *converse-on* command may pass up to 2 data items to the VRU, depending on command parameters specified. You can pass data required by a VRU script or data that selects the VRU script to be run.

Whether or not you pass data, a caller is connected to the VRU, which runs the VRU script. Audible feedback provided by the vector is not heard and no further vector steps are run until the VRU script completes. The VRU may return data to the system and then drops the line to the system. Vector processing continues at the step following the *converse-on* command.

If the call was queued to a nonconverse split before the *converse-on* command was run, the call retains its queue position. If an agent becomes available while the VRU script runs, the system drops the line to the VRU and connects the caller to the agent. The VRU detects the disconnect and terminates the VRU script. For *converse-on* command syntax, see *DEFINITY Enterprise Communications Server Release 6 Call Vectoring/Expert Agent Selection (EAS)*.

Call Prompting allows you to collect and use digits that the VRU returns. These digits are handled as dial-ahead digits. Rules for collecting and processing VRU digits are the same as for Call Prompting.

You can use digits returned from the VRU in the following ways:

- To display for the answering agent's (automatically for 2-line displays or with the CALLR-INFO button for other displays)
- As an extension in a *route-to digits* vector step. For example:

```
converse-on split . . . (VRU returns 4 digits)
collect 4 digits after announcement none
route-to digits coverage y
```

- For vector-conditional branching in an *if digits equals* vector step. For example:

```
converse-on split . . . (VRU returns 1 digit)
collect 1 digit after announcement none
goto vector 101 if digits = 1
goto vector 102 if digits = 2
goto vector 103 if unconditionally
```

- Tandemed to an ASAI host

Collected digits are passed to ASAI hosts in Call Offered to Domain Event reports and in *route request* messages, thus caller digits or database information returned from the VRU can be tandemed through the system to ASAI hosts. For example:

```
converse-on split ... (VRU returns 9 digits)
collect 9 digits after announcement none
adjunct route link Y
```

In this vector, the digits returned from the VRU are forwarded to the ASAI host in the adjunct routing *route request* message.

### SECURITY ALERT:

*When you use a VRU application that returns data for a collect-digits step, the opportunity for toll fraud exists when the VRU application does not return any data. Take the following precautions:*

- If the collected digits are used to route calls internally, ensure that the Class of Restriction (COR) for the vector directory number (VDN) does not allow calls to route externally.



- If the collected digits are used to route calls externally, use a password to verify that the collected digits have been passed by the VRU application. For example, in the following vector, the VRU application returns a 3-digit password followed by the 8-digit external number. The vector routes calls without the correct password to a vector 23.

```
converse-on split 10 pri m passing none and none (VRU returns  
11 digits)  
collect 3 digits after announcement none  
goto vector 23 if digits <> 234  
collect 8 digits after announcement none  
route-to digits with coverage n
```

## Interactions

---

Converse splits interact like other vector-controlled splits unless noted here.

- Adjunct Switch Applications Interface (ASAI)

When a *converse-on* vector step places a call to an ASAI-monitored domain, ASAI event messages are sent over the ASAI link. When a *converse-on* step places an ASAI-monitored call, the ALERT message sent to the ASAI adjunct includes a cause IE, Coding Standard 3 value 23 (CS3/23), which informs the adjunct that the call has not been dequeued from any nonconverse splits.

If a *converse-on* step is run while an adjunct routing request is outstanding, the request is canceled.

ASAI cannot transfer or conference calls, but can direct the system to do this.

- Agents

Although not recommended, you can use a *converse-on* step to deliver a call to a group of human agents. To agents, the call looks like an ACD call, except they cannot use certain features, such as Transfer, Conference, and Supervisor Assist.

The agent can return data to vector processing by pushing the transfer button (or flash hook on analog) and dialing the converse-on data return code and required digits.

- Answer supervision

Answer supervision is returned only once during a call. If a call is answered because of a *converse-on* step, answer supervision is sent if it hasn't previously been sent. If digits are passed to the VRU, answer supervision is sent after digits are sent.

- INTUITY AUDIX

If a *converse-on* step calls AUDIX, the call is handled as a direct call to AUDIX. The caller hears the AUDIX welcome message and can retrieve messages as usual.

If a call is forwarded to a VDN and then delivered to an AUDIX hunt group by a *converse-on* step, the call to AUDIX is treated as a redirected call, and the caller may leave a message.

- Auto-Available Split (AAS)

A *converse-on* vector step can place a call to an AAS. Use auto-available converse splits for VRI except when ASAI controls the converse split.

- Automatic answering

When you administer CONVERSANT ports as agents of a converse split, do not administer agents as automatic answer. The system-provided zip tone may interfere with the interaction between CONVERSANT and the calling party.

- BCMS/CMS

BCMS tracks calls that a *converse-on* step places to a BCMS-measured hunt group. CMS tracks calls that a *converse-on* step places to a CMS-measured hunt group, split, or skill.

The VDN tracks such calls as waiting in the vector. A call is considered answered when answered by a nonconverse split agent, not when answered by a converse split agent. The converse split tracks this as a separate “answered” call when the VRU answers. Though trunk and split totals may no longer match, VDN and trunk totals match.

- Call Detail Recording

The duration of a call to a VDN is recorded from when answer supervision is returned after a successful *converse-on* step. Unsuccessful *converse-on* steps do not generate ineffective call-attempt records. *Converse-on* steps cannot place calls; these steps simply direct a call to a hunt group.

- Call Park

Calls that a *converse-on* step placed cannot be parked.

- Call Pickup

Do not use Call Pickup with *converse-on* steps.

- Class of Restriction

The system does not check CORs when a *converse-on* vector step routes a call to a split.

- Conference

You cannot conference a call routed by a *converse-on* step.

- Direct Department Calling

You can administer a converse split as a DDC split.
- Distributed Communications System

If an incoming DCS call is placed to a vector with a *converse-on split x pri m passing ani...* step, the caller's DCS extension is sent to the VRU.
- Expert Agent Selection

*Converse-on* steps can place calls to a skill hunt group.
- Hold

An agent answering a converse call can put the call on hold, but the caller does not hear music on hold. If a call is queued to a backup split before it was sent to the VRU and a nonconverse split agent answers the call on hold, the agent who placed the call on hold is dropped, and the caller connects to the answering agent.
- Hold — Automatic

Automatic hold applies to converse-on calls.
- Hunt Groups

A *converse-on* step can deliver a call to a vector-controlled or AUDIX hunt group, ACD split, agent skill, or message center.
- ISDN

You can administer a *converse-on* step to send a caller's calling party/billing number (CPN/BN) to CONVERSANT using the caller keyword.
- Intraswitch CDR

If a converse-on call is answered and either the caller or the VDN associated with the call is administered for intraswitch recording, timing for the call is started and the CDR record shows "calling party to VDN" as the originating and answering parties.
- Line-side T1 connectivity

T1 connectivity between the DEFINITY ECS and CONVERSANT is supported for VRI. The DS1 board must be a TN767E (or later) or TN464F (or later). Administer all converse agents as DS1FD-type stations. Operation of the converse step using Line-side T1 is identical to that over a tip/ring line. In particular, delay-timing and output speed is the same as for analog lines. T1 connectivity to CONVERSANT is supported only in the United States and Canada.
- Look-Ahead Interflow

If an incoming call or a call routed by a *converse-on* vector step is answered by a VRU, or is queued to the converse split while a Look-Ahead Interflow call attempt is outstanding, the attempt is accepted.

- Message Center

*Converse-on* steps can deliver calls to message hunt groups. Such calls are handled as direct calls to the message hunt group.

If a call is forwarded to a VDN and a *converse-on* step delivers it to a message split, it is handled as a redirected call.

A *converse-on* step can queue a call to three different skills and then to a converse skill group or split.

- Music-on-Hold

During the data return phase of a *converse-on* step, the caller is placed on hold, but does not hear music.

- Nonvector-controlled splits

A *converse-on* step cannot route a call to a nonvector-controlled split.

- Queuing

*Converse-on* calls queue when they are delivered to busy hunt groups. Call Vectoring audible feedback is not disconnected while a *converse-on* call is queued.

If a *converse-on* step is run while a call is queued to a non-converse split, the call remains in queue, even after being answered by the VRU.

*Converse-on* steps can queue calls at one of four priority levels: low, medium, high or top. You administer the queue priority of a call on the *converse-on* step.

- R2-MFC Signaling

R2-MFC signaling trunks can send ANI to VRUs via the ani data item on the *converse-on* step.

- Recorded announcement

Use VRI to increase the system's recorded announcement capacity by offloading some recorded announcements to a VRU, such as CONVERSANT. Using the *converse-on* step, redirect callers to a group of VRU ports by passing the number of the announcement to be played. CONVERSANT can play any announcement on any port.

Although only one caller can be connected to each port, up to 48 callers can be connected simultaneously to CONVERSANT. The maximum number of callers that can be connected to a VRU simultaneously varies with each VRU.

- Redirection on No Answer (RONA)

If a *converse-on* step calls a hunt group with "no answer timeout" administered, and the call rings an agent/port for longer than the timeout interval, the call redirects and the agent/port is put into AUX work mode (or logged out if the agent is an AAS member).

With RONA, the call is requeued to the split. The call cannot requeue to the split if it is an AAS with all agents logged out or if the queue is full. If the call cannot be requeued, the *converse-on* step fails, a vector event is logged, and processing restarts at the next vector step.

- Service Observing

Calls delivered by a *converse-on* step can be observed. To prevent the observer from hearing tones associated with data being sent to the VRU, the observer is not connected to the call until after data is passed. If the VRU returns data, the observer is put in service-observing-pending mode and the caller is put on hold while the data is sent. When the *converse-on* session ends and the VRU drops the line, the observer remains in service-observing-pending mode and waits for the next call.

In addition, the observer observing a VDN does not hear data being sent. After data is sent, the observer rejoins the call.

Do not administer a service observing warning tone because the warning tone may interfere with the interaction between CONVERSANT and the caller.

- System measurements

System measurements track *converse-on* calls to hunt groups.

- Touch-tone dialing

A caller can use touch-tone dialing while digits are passed in a *converse-on* session. The data is not corrupted. The system does not collect the dialed numbers as dial-ahead digits.

After the system sends digits to CONVERSANT, a caller can enter touch-tone digits at a CONVERSANT prompt. After CONVERSANT has returned data to the system and an additional *collect <#> digits* vector step is run, a caller can enter a touch-tone response to a system prompt.

- Transfer

A call delivered by a *converse-on* step cannot be transferred.

If an attempt to transfer a *converse-on* call is made, a vector event is logged, the line to CONVERSANT is dropped, and processing restarts at the next vector step.

If a human agent tries to transfer a call, the transfer fails and the agent reconnects to the call.

- Transfer out of AUDIX

If a *converse-on* step delivers a call to an AUDIX hunt group and the caller tries to transfer out of AUDIX, the transfer fails and processing continues at the next vector step.

- Uniform Call Distribution (UCD)

You can administer a *converse* split as a UCD split.

- VDN display override

If a call that accesses multiple VDNs encounters a *converse-on* step that passes vdn, normal display override rules determine which VDN number is sent to the VRU.

- Vector-controlled splits

*Converse-on* steps can deliver calls only to skills or vector-controlled splits.

## VuStats

---

VuStats presents Basic Call Management System (BCMS) statistics on voice terminal displays. Agents, supervisors, call center managers, and other users can press a button and view statistics for agents, splits or skills, VDNs, and trunk groups.

These statistics reflect information collected during the current BCMS interval, information collected since the agent logged in or since the day began, or historical data accumulated over an administered number of intervals. The information is limited to 40 characters displayed at a time. VuStats can display on demand or update periodically.

With VuStats, any digital-display voice-terminal user can view BCMS statistics otherwise available only on BCMS reports or management terminals. These statistics can help agents monitor their own performance or can be used to manage splits or small call centers.

### NOTE:

Although VuStats can run with either BCMS or CMS enabled, neither is required.

Figure 9-4 illustrates a CallMaster terminal with a VuStats display.

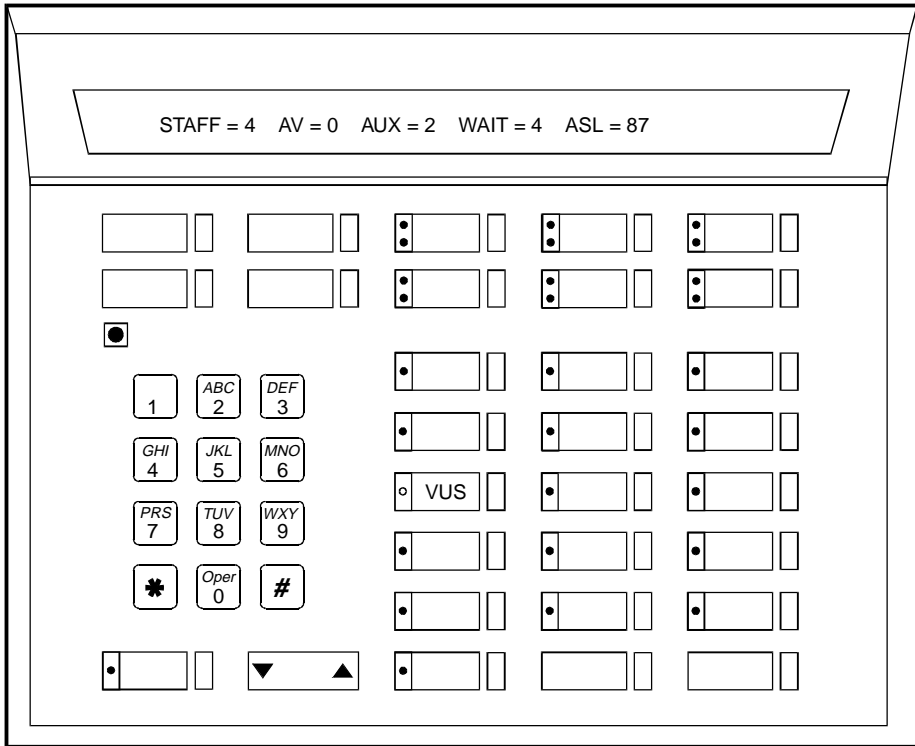

callmstr CJL 061896

Figure 9-4. CallMaster Terminal with VuStats Display



## How to administer VuStats

**Table 9-22. System-Parameter Customer-Options form**

| Form                              | Field                                | Page                  |
|-----------------------------------|--------------------------------------|-----------------------|
| System Parameter Customer-Options | ■ ACD                                | <a href="#">5-277</a> |
|                                   | ■ BCMS/VuStats Login ID              |                       |
|                                   | ■ BCMS/VuStats Service Level         |                       |
|                                   | ■ VuStats or VuStats (G3V4 Enhanced) |                       |

Display the System-Parameter Customer-Options form and ensure that ACD, BCMS/VuStats Login IDs, BCMS/VuStats Service Level, and VuStats or VuStats (G3V4 Enhanced) are set to **yes**.

### Required forms

| Form                              | Field                               | Page                  |
|-----------------------------------|-------------------------------------|-----------------------|
| Feature-Related System Parameters | ■ ACD Login Identification Length   | <a href="#">5-123</a> |
|                                   | ■ BCMS/VuStats Measurement Interval |                       |
|                                   | ■ BCMS/VuStats Abandoned Call Timer |                       |
|                                   | ■ Validate BCMS/VuStats Login IDs   |                       |
|                                   | ■ Clear VuStats Shift Data          |                       |
| Trunk Group                       | ■ Measured                          | <a href="#">7-115</a> |
| Attendant Console                 | ■ Feature Buttons                   | <a href="#">5-35</a>  |
| BCMS/VuStats Login ID             | ■ Login ID, Name                    | <a href="#">9-200</a> |
| Hunt Group                        | ■ ACD                               | <a href="#">5-158</a> |
|                                   | ■ Acceptable Service Level          |                       |
|                                   | ■ Measured                          |                       |
|                                   | ■ Objective                         |                       |
| Voice Terminals (Station)         | ■ Feature Buttons                   | <a href="#">6-14</a>  |
| Vector Directory Number           | ■ Acceptable Service Level          | <a href="#">9-214</a> |
|                                   | ■ Measured                          |                       |
| VuStats                           | ■ All                               | <a href="#">9-161</a> |

- Feature-Related System-Parameters form
  - **ACD Login Identification Length** — If you are not using EAS, enter a number (1–9) that identifies the length of Agent Login IDs used by BCMS/VuStats. If you are not using BCMS/VuStats Login IDs, accept the default 0. This field defines the ACD login ID length and the BCMS login ID length, so you must coordinate with the BCMS administrator before changing this field.
  - **BCMS/VuStats Measurement Interval** — This interval determines how frequently BCMS polls and records data for BCMS reports and VuStats displays. Set this field to **half-hour** or **hour**.

If you specify **hour**, an entire day of traffic information is available for BCMS history reports. Otherwise, only half a day is available. There is a maximum of 25 measurement intervals, including the current interval.
  - **BCMS/VuStats Abandon Call Timer** — Set this field to 1–10, or leave blank. This value is the number of seconds a call can last and still be recorded as an abandoned call. For example, if you set this field to 5, a call could last up to 5 seconds and be recorded as abandoned. Thus, very short calls are not included as ACD calls in BCMS and VuStats statistics. Abandoned time is measured from the time the call is answered until the agent hangs up. Any time an agent is on a call that is within the abandon call timer value is recorded as total AUX time with the default reason code. Use this timer if your central office does not provide disconnect supervision.
  - **Validate BCMS/VuStats Login IDs** — Set to **n** to allow entry of any ACD login of the proper length. Set to **y** to allow entry only of login-IDs that have been entered on the BCMS/VuStats Login-ID form.
  - **Clear VuStats Shift Data**. Set to **on-login** or **at-midnight** to specify when shift data for an agent is cleared.
- Agent Login ID form — Administer Agent Login IDs for EAS. With EAS, VuStats accesses agent and agent-extension object type information based on agent login ID. Agents logging in agent IDs (administered on this form or BCMS/VuStats Login ID form) can view their own statistics on any VuStats voice terminal they are using. If agent IDs are not administered, VuStats displays only statistics collected for the agent's extension.
- Trunk Group form — For each trunk group that will have VuStat display statistics, set Measured to **internal** or **both**. Specify **internal** to record statistics for BCMS/VuStats. Specify **both** to record statistics for BCMS/VuStats and CMS.

- Attendant Console form — Administer a VuStats feature button (vu-display) to allow an attendant to display VuStats statistics. There is no limit to the number of VuStats buttons that can be administered.
  - **Fmt** — When you assign VuStats feature buttons, an Fmt field appears. You can associate a VuStats feature button with a particular display format. The Fmt value identifies the VuStats format used to display the information. Specify 1 — 50 in the Fmt (1 is the default format). See "Format Number" in this section for additional information.
  - **ID number** — Optionally administer an ID number for each vu-display button. Use the ID number to define the agent, split, trunk group, or VDN that the VuStats display will describe. The ID can be an agent login ID or extension number, a split or trunk group number, or a VDN extension. For example, a vu-display button administered with split ID 6 is used to view statistics for split number 6.

Do not administer IDs for VuStats displays with the agent object type. Agent object type displays are limited to statistics for the logged-in agent.

IDs allow supervisors and agents to bypass entering an agent extension, split, or VDN number when viewing statistics. IDs can also be used to limit access to certain statistics to designated voice terminals.

- BCMS/VuStats Login ID form — Administer Agent Login IDs if you do not have EAS. BCMS/VuStats Login IDs can be used to track statistics by specific agent rather than extension number. Specify any character, except a space, to be used as a placeholder for data in Format Description text. \$ is the default. Each character holds a place for one character of data. See "Data Field Character" in this section for more information.
- Hunt Group form
  - **ACD** — Set this field to **y**.
  - **Acceptable Service Level** — Specify the number of seconds within which calls to this hunt group are answered. Calls answered within this time are considered acceptable. BCMS and VuStats use this value to determine the percentage of calls that meet the acceptable service level.
  - **Measured** — Set this field to **internal** or **both**. Specify **internal** to record statistics for BCMS/VuStats. Specify **both** to record statistics for BCMS/VuStats and CMS.
  - **Objective** — Specify an objective, or goal, for the split. Examples include an agent objective of a number of ACD calls to be handled, an average talk time, or a percent of calls to be answered within the acceptable service level.

- Voice Terminal (Station) form — Administer a VuStats feature button (vu-display) to allow agents to display VuStats statistics. See “Attendant Console form” above for more information.
- Vector Directory Number form

For each VDN that has statistics displayed by VuStats, administer the following fields:

- **Acceptable Service Level** — Specify the number of seconds within which calls to this VDN are answered. Calls answered within this time are considered acceptable. BCMS and VuStats use this value to determine the percentage of calls that meet the acceptable service level.
- **Measured** — Set this field to **internal** or **both**. Specify **internal** to record statistics for BCMS/VuStats. Specify **both** to record statistics for BCMS/VuStats and CMS.
- VuStats Display Format form
  - **Format Number** — The system generates a format number automatically when it creates a VuStats display. You cannot change this number. You can create 50 different display formats. Format Number 1 is a predefined sample format that you can modify. See “Attendant Console form” in this section for more information.
  - **Next Format Number** — Specify the number of the display to be shown after the current display when a user presses the “next” button. To link displays, administer a next button Attendant Console or Station form. In general, you only link displays with the same object type.
  - **Number of Intervals** — Specify the number of BCMS intervals used to collect data when you have specified **interval** as the period for a historical Data Type. For example, if the BCMS interval is 1 hour and you specify 8 in this field, historical data with a period of interval is based on the previous 8 hours. See “Period” in this section for more information.
- **Object Type** — Set this field to one of five object types: **agent**, **agent-extension**, **split**, **trunk-group**, and **VDN**. Each object type displays specific types of data.
  - **Agent** — Provides agents with their own statistics, or statistics about the splits/skills they log into.
  - **Agent-extension** — Provides supervisors with statistics about agents or the splits/skills the agents log into. VuStats can automatically display statistics for a specific agent (if you administer agent login ID or BCMS/Vustats Login ID). Or, supervisors can enter the ID of any agent they want to review.
  - **Split** — Displays statistics about a specific split/skill. You must administer the split as Measured (internal or both) on the Hunt Group form.

- **Trunk-group** — Displays statistics about a specific trunk group. You must administer the trunk group as Measured (internal or both) on the Trunk Group form.
- **VDN** — Displays statistics about a specific VDN. You must administer the VDN as Measured (internal or both) on the Vector Directory Number form.

See [“What information is displayed” on page 9-170](#) in this section for a description of data that is displayed for each object type.

- **Data Type** — Specify data types to define what data is displayed for each object type. You can specify up to 10 data types for each display. See [Table 9-173](#) for a description of data types associated with each object type.
- **Period** — Set the amount of time to be used to collect the historical data for display. Set this field to **day**, **interval**, or leave blank. Day displays all data collected for a Data Type since midnight. Interval displays all data collected for a Data Type during the number of intervals specified in Number of Intervals ending with the current interval. Leaving the field blank displays only the data collected for the current interval.
- **Threshold** — Specify the conditions under which the VuStats button lamp flashes, alerting agents when there is a problem. Set both a comparator and a threshold value. For example, if you want to alert agents when the percent of calls within acceptable service level drops below 90%, specify the split-percent-in-service-level data type with a Threshold comparator of  $\leq$  and a threshold value of 90.
- **Split Reference** — Some data types associated with agent and agent-extension object types display statistics about the split/skill an agent is logged into. These data types usually begin with the word split. For example, the data type “split-agents-available” displays how many agents are available on a specific split or all splits the agent is logged into.
- Specify a reference number with the data type to define which split the displayed data is for. The reference number also describes the order in which an agent logged into the split. For example, specifying reference number 1 for the data type “split-agents-available” displays the number of agents available on the first split the agent is logged into.

Specify **Top** to display the first-administered highest-level skill for EAS agents, or the first split logged into for non-EAS agents. Specifying **All** displays data for all splits the agent is logged into and is valid only for acd-calls, average-acd-talk-time, shift-acd-calls, and shift-average-acd-talk-time data types.

- **Data Field Character** — Specify any character, except a space, to be used as a placeholder for data in the Format Description. \$ is the default. For example, in the entry “AUX=\$\$” the dollar signs each hold a place for one character of data.
- **Format Description** — Specify the text to be displayed with a data type, followed by Data Field Characters needed as placeholders for data-type data. List data types in the Data Type fields in the same order that the data type text appears in Format Description.

For example, in [Screen 9-2](#), STAFF, AV, AUX, WAIT, and ASL are all text labels for data types. STAFF is associated with the first data type, split-agents-staffed, AV is associated with the second data type, split-agents-available, and so on.

```

                                VUSTATS DISPLAY FORMAT
Format Number: 1                      Object Type: agent
Next Format Number: 2                  Update Interval: 30      On Change? n
Data Field Character: $
Number of Intervals:

Format Description: STAFF=$$ AV=$$ AUX=$$ WAIT=$$$$$$ ASL=$$$

Data Type                               Format   Period   Threshold   Ref
1: split-agents-staffed
2: split-agents-available
3: split-agents-in-aux-all
4: split-oldest-call-waiting           m:ss
5: split-acceptable-service-level      m:ss
.
.
    
```

Screen 9-2. Format Description Example

If the data for a field is too large for the number of data field characters entered, VuStats displays asterisks. If name database items are too large for the number of data field characters, VuStats truncates the data. VuStats also displays Split Objective (assigned on the Hunt Group form) as asterisks if the information exceeds the data field size.

- **Format** — Specify the format of data that has a time value. Format is required for time-value data types such as “split-oldest-call-waiting”. Specify one of the following:
  - **ccs** -- Hundred-call seconds (CCS) rounded to the nearest CCS
  - **h** -- Hours rounded to the nearest hour
  - **h:mm** -- Hours and minutes rounded to the nearest minute
  - **h:mm:ss** -- Hours, minutes, and seconds

- **m** -- Minutes rounded to the nearest minute
  - **m:ss** -- Minutes and seconds
  - **s** -- Seconds
- **Update Interval** — Set the interval at which the VuStats display data is updated to one of the following:
- **no-update** — The display does not update and appears only for the interval specified in the Display Interval field.
  - **polled** — The display updates every hour or half-hour depending upon the value in BCMS/ VuStats Measurement Interval on the Feature-Related System-Parameters form.  
  
Specifying polled may impact system performance at the time of the measurement interval.
  - **10, 20, 30, 60, 120** — The display updates every 10, 20, 30, 60, or 120 seconds.
- **On Change** — Specify whether the display will update whenever the agent changes work state. Set this field to **y** or **n**. If set to **y**, the display updates when the agent changes state and updates according to the Update Interval.
- **Display Interval** — Administer only if you specified a no update Update Interval. Specify one of the following:
- **not-cleared** — The display does not clear. The display remains until it is overwritten by another feature or the user presses the normal button.
  - **5, 10, 15, 30** — The display clears after 5, 10, 15, or 30 seconds.

## Detailed description

---

### What information is displayed

The following forms and fields determine information that VuStats displays.

---

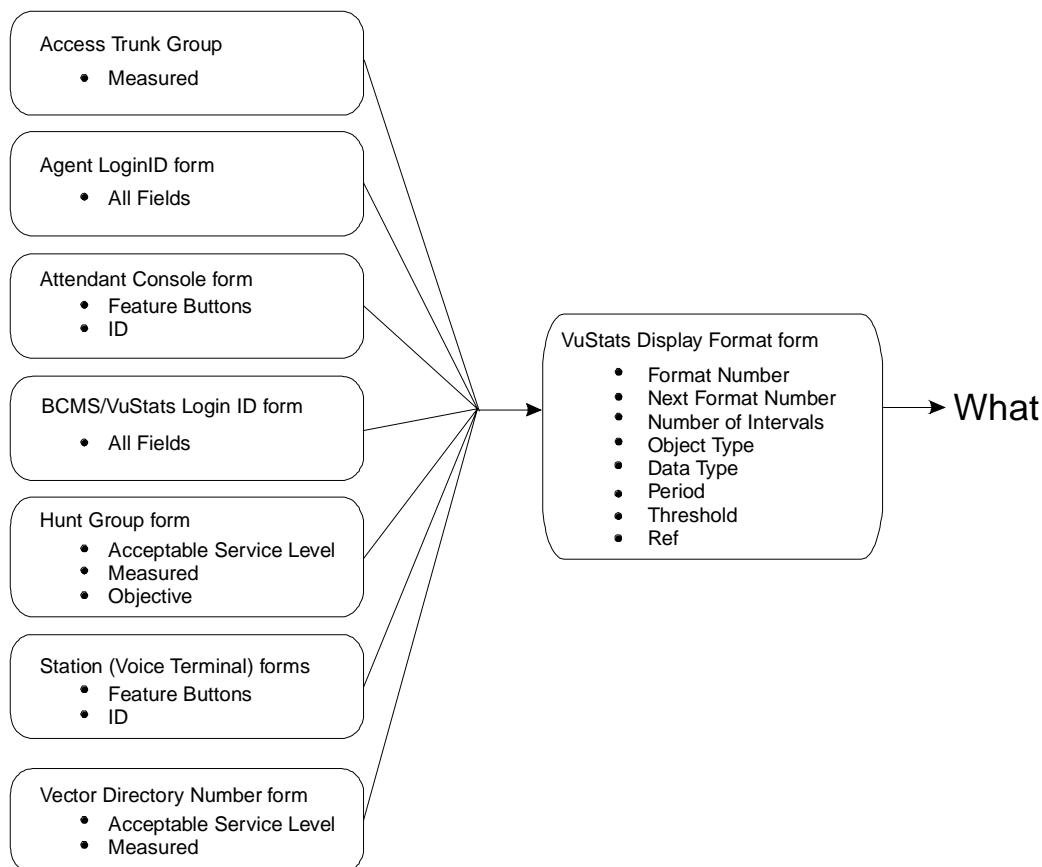

Figure 9-5. Forms that Determine What Information Appears on the VuStats Display

### Data Type

Data type defines what data is displayed for an object type. For example, for an agent object type, VuStats can display information agents are interested in, such as the total number of calls the agent has answered since login, the average time the agent has spent on ACD calls, the number of agents available to receive calls for a split, and the percent of calls within the acceptable service level.



For split object types, VuStats can display split description and performance information, such as average speed of answer, number of calls waiting, and agent work states. VuStats can also display an objective, acceptable service level, or percent of calls answered within the acceptable service level for a split.

See [Table 9-182](#) and [Table 9-186](#) for more information on data types.

## Period

VuStats can show statistics that have accumulated for the day, or for an administered number of intervals. For example, if you administer VuStats to display the number of ACD calls for the past 4 completed intervals, it displays the number of ACD calls received in the past 2 hours (1/2-hour intervals) or 4 hours (1-hour intervals) plus those completed during the current interval. Using historical data can affect processor occupancy, depending upon the number of active users, their update rates, and the number of historical data types.

With agent or agent-extension object types, shift data is available for the number of ACD calls answered, the average ACD talk time, and AUX work mode time by Reason Code for an agent. You can clear shift data at midnight or the next time an agent logs in.

## Threshold

Many data types can be administered with a threshold comparator and value. When the condition defined by the threshold is true, and the data type is shown on the display, the VuStats button lamp flashes. For example, suppose a format is created in which the oldest call waiting data type is administered with a threshold of  $\geq$  (greater than or equal to) five minutes. Whenever that VuStats format is displayed, if the oldest call in queue has been waiting for five minutes or longer, the VuStats lamp flashes on the voice terminal. Each time the display updates, the threshold is checked for each data type being displayed.

## Format description

Use Format Description to create labels on the display to identify data. For example, in [Figure 9-4](#) "AUX=" identifies the data type "split-agents-in-aux-all" (that is, the number of agents currently in AUX work mode for a specified split). Text appears on the display exactly as you enter it in the field. Text is optional.

Because of the 40-character limit, use abbreviations when possible. For example, use "S=" to indicate "split number".

## Display linking

Link display formats to increase the amount of information users can view. For example, link a display of information for an agent's first split to a display of information for the agent's second split. Or, link a display of information about the work states of all agents on a split linked to another display of information about calls waiting, number of calls abandoned, or oldest call waiting for the split.

If you use display linking, assign a Next button on agent terminals.

## How the information looks

The following fields on the VuStats Display form determine how information looks on the VuStats display.

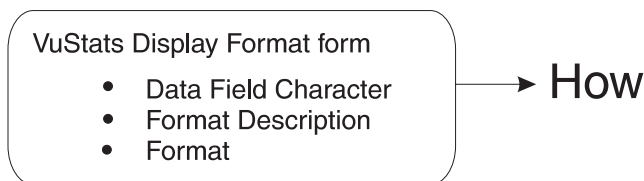

---

**Figure 9-6. Fields that Determine What Information Appears on the VuStats Display**

VuStats statistics appear on the second line of 2-line DCP terminal displays or on the first line of 1-line DCP terminals and all BRI terminals. On voice terminals with 2 x 24 displays, the display automatically wraps to the second line of the display. When VuStats is activated, it overwrites and cancels any display feature on the second line of a 2-line display and on the first line of a 1-line display.

You define the following format information on the VuStats Display Format form:

- Labels for data types and the amount of space reserved for data
- Order in which data types appear on the display
- Format for time-related data types
- Display links

## When the information updates

The following forms and fields determine when VuStats displays update.

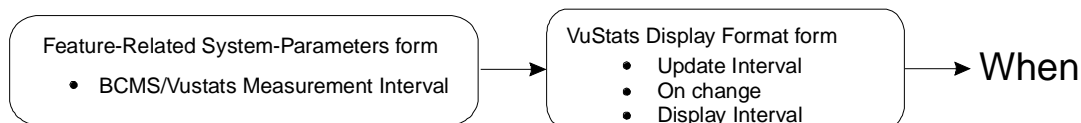

---

**Figure 9-7. Fields that Determine When Information Updates on the VuStats Display**

Most display features that use the second line of a 2-line display or the first line of a 1-line display overwrite and cancel VuStats. Reason Codes and Call Work Codes only suspend VuStats; when the prompt is removed, the VuStats display reappears.

User press the normal button to clear the VuStats display.

Administer VuStats to display information until agents press the normal button or another operation overwrites the VuStats display. Or, administer VuStats to display for an interval of 5, 10, 15, or 30 seconds.

You can also administer VuStats to update displayed statistics every 10, 20, 30, 60 or 120 seconds or every time an agent changes work mode or a BCMS Measurement Interval is completed, or not update at all.

## Tables of Data Types

[Table 9-23](#), [Table 9-24](#), [Table 9-25](#) and [Table 9-26](#) describe the data types you can define for each object type.

**Table 9-23. Agent and Agent-Extension Data Types**

| VuStats Data Type     | Description  | BCMS Report: Field Name/Column Heading                |
|-----------------------|--|---|
| acd-calls             | Split/skill calls and direct agent calls answered by an agent  | Split status/VDN Status/Agent Report: ACD CALLS       |
| agent-extension       | The extension for a specific agent; if either BCMS/VuStats Login IDs or EAS is optioned, then this shows the agent's login ID. | Split Status: Login ID or EXT                         |
| agent-name            | The administered name for a specific agent.  | Split Status/Agent Report/Agent Summary Report: Agent |
| agent-state           | The agent's current work state   | Split Status: STATE                                   |
| average-acd-call-time | The average of hold-time plus talk-time.   | None  |

*Continued on next page*

Table 9-23. Agent and Agent-Extension Data Types — *Continued*

| VuStats Data Type        | Description  | BCMS Report: Field Name/Column Heading           |
|--------------------------|--|--|
| average-acd-talk-time    | The average time a specific agent has spent talking on completed ACD calls during a specified time period for all internally-measured splits/skills that the agent was logged into. This does not include the time a call was ringing or was on hold at an agent's terminal. | Agent Report/Agent Summary Report: AVG TALK TIME |
| average-extension-time   | The average amount of time an agent spent on non-ACD calls while logged into at least one split/skill during the reported interval. This average does not include time when the agent was holding the EXTN call.   | Agent Report/Agent Summary Report: AVG EXTN TIME |
| call-rate                | The current rate of ACD calls handled per agent per hour for all split/skills.   | None   |
| current-reason-code      | The number of the Reason Code associated with the agent's current AUX work mode, or with the agent's logout.   | None   |
| current-reason-code-name | The name of the Reason Code associated with the agent's current AUX work mode or with the agent's logout.  | None   |
| elapsed-time-in-state    | The amount of time an agent has been in the current state.   | None   |
| extension-calls          | The number of incoming and outgoing non-ACD calls that an agent completed while logged into at least one split/skill.  | Agent Report: EXTN CALLS                         |
| extension-incoming-calls | The number of non-ACD calls that an agent receives while logged into at least one split/skill.   | Split Report: EXT IN CALLS                       |
| extension-outgoing-calls | The number of non-ACD calls that an agent places while logged into at least one split/skill.   | Split Report: EXT OUT CALLS                      |

*Continued on next page*

Table 9-23. Agent and Agent-Extension Data Types — *Continued*

| VuStats Data Type  | Description   | BCMS Report: Field Name/Column Heading |
|--------------------|---|--|
| shift-acd-calls    | The number of ACD calls answered by an agent during the administered period.                                | None                                   |
| shift-aux-time-1   | The amount of time an agent has spent in AUX work mode for Reason Code 1 during the administered period.    | None                                   |
| shift-aux-time-2   | The amount of time an agent has spent in AUX work mode for Reason Code 2 during the administered period.    | None                                   |
| shift-aux-time-3   | The amount of time an agent has spent in AUX work mode for Reason Code 3 during the administered period.    | None                                   |
| shift-aux-time-4   | The amount of time an agent has spent in AUX work mode for Reason Code 4 during the administered period.    | None                                   |
| shift-aux-time-5   | The amount of time an agent has spent in AUX work mode for Reason Code 5 during the administered period.    | None                                   |
| shift-aux-time-6   | The amount of time an agent has spent in AUX work mode for Reason Code 6 during the administered period.    | None                                   |
| shift-aux-time-7   | The amount of time an agent has spent in AUX work mode for Reason Code 7 during the administered period.    | None                                   |
| shift-aux-time-8   | The amount of time an agent has spent in AUX work mode for Reason Code 8 during the administered period.    | None                                   |
| shift-aux-time-9   | The amount of time an agent has spent in AUX work mode for Reason Code 9 during the administered period.    | None                                   |
| shift-aux-time-all | The amount of time an agent has spent in AUX work mode for all Reason Codes during the administered period. | None                                   |

*Continued on next page*

Table 9-23. Agent and Agent-Extension Data Types — Continued

| VuStats Data Type              | Description   | BCMS Report: Field Name/Column Heading                     |
|--------------------------------|---|--|
| shift-aux-time-default         | The amount of time an agent has spent in AUX work mode for the default Reason Code (code 0) during the administered period.   | None   |
| shift-aux-time-non-default     | The amount of time an agent has spent in AUX work mode for Reason Codes 1 through 9 during the administered period.   | None   |
| shift-aux-time-reason-code     | The amount of time an agent has spent in AUX work mode for the agent's current Reason Code during the administered period.  | None   |
| shift-average-acd-talk-time    | The average talk time for ACD calls for a specific agent during the administered period.  | None   |
| skill-level                    | The skill level at which the skill was assigned to the agent.   | None   |
| split-acceptable-service-level | The number of seconds within which calls must be answered to be considered acceptable. Identified on a per-hunt group basis. Timing begins when the call enters the hunt group queue. | Split Status: Acceptable Service Level                     |
| split-acd-calls                | Split/skill calls and direct agent calls answered by an agent.  | System Status/Split Report/Split Summary Report: ACD CALLS |
| split-after-call-sessions      | The number of times all agents have entered After Call Work (ACW) for a specific split/skill.   | None   |
| split-agents-available         | The number of agents currently available to receive ACD calls for a specific split. This includes agents in Auto-In or Manual-In work mode.   | Split Status: Avail  |
| split-agents-in-after-call     | For a specific split, the number of agents currently in ACW.  | Split Status: ACW  |

Continued on next page

Table 9-23. Agent and Agent-Extension Data Types — *Continued*

| VuStats Data Type           | Description  | BCMS Report: Field Name/Column Heading |
|-----------------------------|--|--|
| split-agents-in-aux-1       | For a specific skill, the number of agents currently in Aux work mode with Reason Code 1.                          | None                                   |
| split-agents-in-aux-2       | For a specific skill, the number of agents currently in Aux work mode with Reason Code 2.                          | None                                   |
| split-agents-in-aux-3       | For a specific skill, the number of agents currently in Aux work mode with Reason Code 3.                          | None                                   |
| split-agents-in-aux-4       | For a specific skill, the number of agents currently in Aux work mode with Reason Code 4.                          | None                                   |
| split-agents-in-aux-5       | For a specific skill, the number of agents currently in Aux work mode with Reason Code 5.                          | None                                   |
| split-agents-in-aux-6       | For a specific skill, the number of agents currently in Aux work mode with Reason Code 6.                          | None                                   |
| split-agents-in-aux-7       | For a specific skill, the number of agents currently in Aux work mode with Reason Code 7.                          | None                                   |
| split-agents-in-aux-8       | For a specific skill, the number of agents currently in Aux work mode with Reason Code 8.                          | None                                   |
| split-agents-in-aux-9       | For a specific skill, the number of agents currently in Aux work mode with Reason Code 9.                          | None                                   |
| split-agents-in-aux- all    | For a specific split/skill, the total number of agents currently in Aux work mode for all Reason Codes.            | Split Status: AUX                      |
| split-agents-in-aux-default | For a specific split/skill, the number of agents currently in Aux work mode with the default Reason Code (code 0). | None                                   |

*Continued on next page*

Table 9-23. Agent and Agent-Extension Data Types — Continued

| VuStats Data Type               | Description  | BCMS Report: Field Name/Column Heading                         |
|---------------------------------|--|--|
| split-agents-in-aux-non-default | For a specific skill, the number of agents currently in Aux work mode with Reason Codes 1 through 9.   | None   |
| split-agents-in-other           | The number of agents currently who: are on a call for another split, are in ACW work mode for another split, have a call on hold but are not in another state, or have a call ringing at their terminals, or are dialing a number while in AI/MI.  | Split Status: Other  |
| split-agents-on-acd-calls       | The number of agents currently on split/skill or direct agent ACD calls for a specific split.  | Split Status: ACD  |
| split-agents-on-extension-calls | The number of agents in a specific split who are currently on non-ACD calls.   | Split Status: Extn   |
| split-agents-staffed            | The number of agents currently logged into a split.  | Split Status: Staffed  |
| split-average-acd-talk-time     | The average talk time for ACD calls during a specific period/day for a specified split.  | System Status/Split Report/Split Summary Report: AVG TALK TIME |
| split-average-after-call-time   | The average time for call-related ACW completed by agents for this split (the same as average-after-call-time, but only available for agent and agent-extension object types). Call-related ACW time is recorded when an agent leaves the ACW state. If an agent is in call-related ACW when an interval completes, all of the ACW time will be recorded for the interval in which the agent leaves ACW. | System Status: AVG AFTER CALL                                  |
| split-average-speed-of-answer   | The average speed for answering split and direct agent ACD calls that have completed for a specified split/skill.  | System Status/Split Report/Split Summary Report: AVG SPEED ANS |

Continued on next page



Table 9-23. Agent and Agent-Extension Data Types — Continued

| VuStats Data Type             | Description  | BCMS Report: Field Name/Column Heading                          |
|-------------------------------|--|---|
| split-average-time-to-abandon | The average time calls waited in queue and ringing before abandoning.  | System Status/Split Report/Split Summary Report: AVG ABAND TIME |
| split-call-rate               | The current rate of ACD calls handled per agent per hour for a specific split or skill.  | None  |
| split-calls-abandoned         | The number of calls that abandoned from queue (provided this is the first split/skill queued to) or abandoned from ringing.  | System Status/Split Report/Split Summary Report: ABAND CALLS    |
| split-calls-flowed-in         | The total number of calls for a specific split/skill that were received as a coverage point (intraflowed) from another internally-measured split/skill, or were call-forwarded (interflowed) to the split/skill. | Split Report/Split Summary Report: FLOW IN                      |
| split-calls-flowed-out        | The total number of calls for a specific split/skill that successfully extended to the split/skill's coverage point, were call-forwarded out, or were answered via call pick-up.                                 | Split Report/Split Summary Report: FLOW OUT                     |
| split-calls-waiting           | The number of calls that have encountered a split but have not been answered, abandoned, or outflowed.   | System Status: CALLS WAIT                                       |
| split-extension               | The administered extension for a split.  | None  |
| split-name                    | The administered name for a split/skill.   | Split Report/Split Status: Split Name<br>System Status: SPLIT   |
| split-number                  | The administered number for a split/skill.   | Split Report/Split Status: Split Name<br>System Status: SPLIT   |
| split-objective               | The administered objective for a split/skill.  | None  |

Continued on next page

Table 9-23. Agent and Agent-Extension Data Types — Continued

| VuStats Data Type              | Description   | BCMS Report: Field Name/Column Heading                                  |
|--------------------------------|---|---|
| split-oldest-call-waiting      | The time the oldest call has been waiting for a specific split/skill.   | System Status:<br>OLDEST CALL   |
| split-percent-in-service-level | For a specific split/skill, the percentage of calls answered within the administered service level on the hunt group form.  | System Status/Split Report/Split Summary Report: % WITHIN SERVICE LEVEL |
| split-total-acd-talk-time      | For a specified split/skill, the total time agents spent talking on split/skill calls and direct agent calls for this split.  | None  |
| split-total-after-call-time    | The total time an agent spent in call-related ACW for this split/skill and non-call-related ACW for any split/skill during a specific time period, excluding time spent on incoming or outgoing extension calls while in ACW.   | Split Report/Split Summary Report:<br>TOTAL AFTER CALL                  |
| split-total-aux-time           | The total time an agent spent in AUX mode for this split/skill.   | Split Report/Split Summary Report:<br>TOTAL AUX/OTHER                   |
| total-acd-call-time            | The total talk time plus the total hold time for split/skill and Direct Agent ACD calls.  | None  |
| total-acd-talk-time            | The total time agents spent talking on split/skill calls and direct agent calls.  | None  |
| total-after-call-time          | The total time an agent spent in call-related or non-call-related ACW for any split during a specific time period, excluding time spent on incoming or outgoing extension calls while in ACW. (With EAS, all non-call related ACW time is associated with the first skill logged into.) | Agent Report/Agent Summary Report:<br>TOTAL AFTER CALL                  |

Continued on next page

Table 9-23. Agent and Agent-Extension Data Types — *Continued*

| VuStats Data Type    | Description  | BCMS Report: Field Name/Column Heading                |
|----------------------|--|---|
| total-aux-time       | The total time an agent spent in AUX work for all splits/skills (simultaneously) that the agent was logged into. If an agent entered AUX in one interval, but ended AUX in another, each of the intervals will reflect the appropriate amount of time spent in the interval (agent reports also include OTHER time). | Agent Report/Agent Summary Report:<br>TOTAL AUX/OTHER |
| total-available-time | The time an agent was available in at least one split/skill.   | Agent Report:<br>TOTAL AVAIL TIME                     |
| total-hold-time      | The total amount of time ACD calls were on hold at a specific agent's voice terminal. This time is the "caller's hold time" and is independent of the agent's state. This time does not include hold time for non-ACD calls on hold.   | Agent Report:<br>TOTAL HOLD TIME                      |
| total-staffed-time   | The total amount of time an agent was logged into one or more splits/skills during a specific period/day. An agent is clocked for staff time as long as he or she is logged into any split.  | Agent Report:<br>TOTAL TIME STAFFED                   |

Table 9-24. Split Data Types

| VuStats Data Type        | Description   | BCMS Report: Field Name/Column Heading              |
|--------------------------|---|---|
| acceptable-service-level | The number of seconds within which calls must be answered to be considered acceptable. Identified on a per-hunt group basis. Timing begins when the call enters the hunt group queue. | Split Status/Split Report: Acceptable Service Level |
| acd-calls                | Split calls and direct agent calls answered by an agent   | Split status/VDN Status/Agent Report: ACD CALLS     |
| after-call sessions      | The number of times all agents have entered After Call Work (ACW).  | None  |
| agents-available         | The number of agents currently available to receive ACD calls. This includes agents in Auto-In or Manual-In work mode.  | Split Status: Avail                                 |
| agents-in-after-call     | The number of agents currently in ACW mode.   | Split Status: ACW                                   |
| agents-in-aux-1          | The number of agents currently in Aux work mode for Reason Code 1 for the referenced skill.   | None  |
| agents-in-aux-2          | The number of agents currently in Aux work mode for Reason Code 2 for the referenced skill.   | None  |
| agents-in-aux-3          | The number of agents currently in Aux work mode for Reason Code 3 for the referenced skill.   | None  |
| agents-in-aux-4          | The number of agents currently in Aux work mode for Reason Code 4 for the referenced skill.   | None  |
| agents-in-aux-5          | The number of agents currently in Aux work mode for Reason Code 5 for the referenced skill.   | None  |
| agents-in-aux-6          | The number of agents currently in Aux work mode for Reason Code 6 for the referenced skill.   | None  |

Continued on next page

Table 9-24. Split Data Types — *Continued*

| VuStats Data Type         | Description   | BCMS Report: Field Name/Column Heading |
|---------------------------|---|--|
| agents-in-aux-7           | The number of agents currently in Aux work mode for Reason Code 7 for the referenced skill.   | None                                   |
| agents-in-aux-8           | The number of agents currently in Aux work mode for Reason Code 8 for the referenced skill.   | None                                   |
| agents-in-aux-9           | The number of agents currently in Aux work mode for Reason Code 9 for the referenced skill.   | None                                   |
| agents-in-aux-all         | The number of agents currently in Aux work mode for all Reason Codes for the referenced split/skill.  | Split Status: AUX                      |
| agents-in-aux-default     | The number of agents currently in Aux work mode for the default Reason Code (code 0) for the referenced split/skill.  | None                                   |
| agents-in-aux-non-default | The number of agents currently in Aux work mode for Reason Codes 1 through 9 for the referenced skill.  | None                                   |
| agents-in-other           | The number of agents who currently: are on a call for another split, are in ACW work mode for another split, have a call on hold but are not in another state, or have a call ringing at their terminal, or are dialing a number from AI/MI mode. | Split Status: Other                    |
| agents-on-acd-calls       | The number of agents currently on split/skill or direct agent ACD calls for a specific split.   | Split Status: ACD                      |
| agents-on-extension-calls | The number of agents in a specific split who are currently on non-ACD calls.  | Split Status: Extn                     |
| agents-staffed            | The number of agents currently logged into the specified split.   | Split Status: Staffed                  |

*Continued on next page*

Table 9-24. Split Data Types — *Continued*

| VuStats Data Type       | Description  | BCMS Report: Field Name/Column Heading     |
|-------------------------|--|--|
| average-acd-talk-time   | The average talk time for ACD calls during a specific period/day for a specified split.  | System Status/Split Report: AVG TALK TIME  |
| average-after-call-time | The average time for call-related ACW completed by agents in this split. Call-related ACW time is recorded when an agent leaves the ACW state. If an agent is in call-related ACW when an interval completes, all of the ACW time will be recorded for the interval in which the agent leaves ACW.         | System Status: AVG AFTER CALL              |
| average-speed-of-answer | The average speed for answering split/skill and direct agent ACD calls that have completed for a specified split/skill during a specified time. This includes queue time and ringing time for this split.  | System Status/Split Report: AVG SPEED ANS  |
| average-time-to-abandon | The average time calls waited before abandoning.   | System Status/Split Report: AVG ABAND TIME |
| call-rate               | The current rate of ACD calls handled per agent per hour for all split/skills.   | none                                       |
| calls-abandoned         | The number of calls that abandoned.  | System Status/Split Report: ABAND CALLS    |
| calls-flowed-in         | The total number of calls for a specific split that were received as a coverage point (intraflowed) from another internally-measured split, or were call-forwarded (interflowed) to the split. This does not include calls that were interflowed from a remote switch by the Look Ahead Interflow feature. | Split Report/Split Summary Report: FLOW IN |

*Continued on next page*

Table 9-24. Split Data Types — *Continued*

| VuStats Data Type         | Description  | BCMS Report: Field Name/Column Heading                           |
|---------------------------|--|--|
| calls-flowed-out          | The number of calls the split extended to its coverage point, calls that call-forward out or are answered by call pickup, calls that queued to this split as a primary split and were answered or abandoned from ringing in another split. | Split Report/Split Summary Report: FLOW OUT                      |
| calls-waiting             | The number of calls that have encountered a split/skill but have not been answered, abandoned, or outflowed.   | System Status: CALLS WAIT  |
| oldest-call-waiting       | The time the oldest call has been waiting in the split/skill. Timing begins when the call enters the split/skill.  | System Status: OLDEST CALL                                       |
| percent-in-service- level | The percentage of calls offered to the split that were answered within the service level administered on the hunt group form.  | System Status/Split Report/Split Summary Report: % IN SERV LEVEL |
| split-extension           | The administered extension for a split.  | None   |
| split-name                | The administered name for a split.   | Split Report/Split Status: Split Name<br>System Status: SPLIT    |
| split-number              | The administered number for a split.   | Split Report/Split Status: Split Name<br>System Status: SPLIT    |
| split-objective           | The administered objective for a split.  | None   |
| total-acd-talk-time       | The total time agents spent talking on split/skill calls and direct agent calls for this split.  | None   |

*Continued on next page*

Table 9-24. Split Data Types — Continued

| VuStats Data Type     | Description  | BCMS Report: Field Name/Column Heading              |
|-----------------------|--|---|
| total-after-call-time | The total time agents spent in call-related or non-call-related ACW for any split during a specific time period.                 | Split Report/Split Summary Report: TOTAL AFTER CALL |
| total-aux-time        | The total time agents spent in AUX work mode for all Reason Codes for the referenced split/skill during the administered period. | Split Report/Split Summary Report: TOTAL AUX/OTHER  |

Table 9-25. VDN Data Types

| VuStats Data Type        | Description  | BCMS Report: Field Name/Column Heading                  |
|--------------------------|--|---|
| acceptable-service-level | The number of seconds within which calls must be answered to be considered acceptable. Identified on a per-VDN basis. Timing begins when the call enters the vector. | VDN Status/VDN Report: Acceptable Service Level         |
| acd-calls                | Split calls and direct agent calls answered by an agent  | VDN Status: ACD CALLS                                   |
| average-acd-talk-time    | The average talk time for ACD calls during a specific period/day for a specified VDN.  | VDN Status/Split Report: AVG TALK HOLD                  |
| average-speed-of-answer  | The average speed for answering ACD and CONNect calls that have completed for a specified VDN during a specified time. This includes time in vector processing.      | VDN Status/VDN Report/VDN Summary Report: AVG SPEED ANS |
| average-time-to-abandon  | The average time calls waited before abandoning.   | VDN Status/VDN Report: AVG ABAND TIME                   |

Continued on next page



Table 9-25. VDN Data Types — *Continued*

| VuStats Data Type         | Description  | BCMS Report: Field Name/Column Heading                    |
|---------------------------|--|---|
| calls-abandoned           | The number of calls that abandoned.  | VDN Status/VDN Report/VDN Summary Report: ABAND CALLS     |
| calls-flowed-out          | The total number of calls for a specific VDN that successfully routed to another VDN or off the switch.  | VDN Status/VDN Report/VDN Summary Report: FLOW OUT        |
| calls-forced-busy-or-disc | The number of calls given forced busy or forced disconnect.  | VDN Status/VDN Report/VDN Summary Report: CALLS BUSY/DISC |
| calls-offered             | All calls offered to a VDN, including ACD calls, connected calls, abandoned calls, busy calls (calls that received a busy signal), disconnected calls (calls disconnected by the switch), and outflow calls (calls directed to another VDN or off-switch destination). | VDN Status/VDN Report/VDN Summary Report: CALLS OFFERED   |
| calls-waiting             | The number of calls that have encountered a VDN, but have not been answered, abandoned, or outflowed.  | VDN Status: CALLS WAIT                                    |
| non-acd-connected-calls   | The number of non-ACD calls routed from a specific VDN that were connected to an extension.  | VDN Status/VDN Report/VDN Summary Report: CONN CALLS      |
| oldest-calling-waiting    | The time the oldest call has been waiting in the VDN. Timing begins when the call enters the vector.   | VDN Status: OLDEST CALL                                   |
| percent-in-service-level  | The percentage of calls offered to the VDN that were answered within the service level administered for the VDN.   | VDN Status/VDN Report/VDN Summary Report: % IN SERV LEVEL |
| total-acd-talk-time       | The total time agents spent talking on split/skill calls and direct agent calls.   | None  |

*Continued on next page*

Table 9-25. VDN Data Types — Continued

| VuStats Data Type | Description                                       | BCMS Report: Field Name/Column Heading  |
|-------------------|---|---|
| vdn-extension     | The extension of a vector directory number (VDN). | VDN Status/VDN Report: VDN EXT          |
| vdn-name          | The name of a vector directory number (VDN).      | VDN Status/VDN Summary Report: VDN NAME |

Table 9-26. Trunk Group Data Types

| VuStats Data Type          | Description  | BCMS Report: Field Name/Column Heading |
|----------------------------|--|--|
| average-incoming-call-time | Average holding time for incoming trunk calls.                                       | Trunk Group: INCOMING TIME             |
| average-outgoing-call-time | Average holding time for outgoing trunk calls.                                       | Trunk Group: OUTGOING TIME             |
| incoming-abandoned-calls   | Incoming calls abandoned during a specified time period for a specified trunk group. | Trunk Group: INCOMING ABAND            |
| incoming-calls             | Incoming calls carried by a specified trunk group.                                   | Trunk Group: INCOMING CALLS            |
| incoming-usage             | The total trunk holding time for incoming calls in hundred call seconds.             | Trunk Group: INCOMING CCS              |
| number-of-trunks           | The number of trunks in a specified trunk group.                                     | Trunk Group: Number of Trunks          |
| outgoing-calls             | The number of outgoing calls carried by a specified trunk group.                     | Trunk Group: OUTGOING CALLS            |
| outgoing-completed-calls   | The number of outgoing calls that received answer supervision or answer timeout.     | Trunk Group: OUTGOING COMP             |
| outgoing-usage             | The total trunk holding time for outgoing calls in hundred call seconds.             | Trunk Group: OUTGOING CCS              |

Continued on next page

Table 9-26. Trunk Group Data Types — *Continued*

| VuStats Data Type         | Description  | BCMS Report: Field Name/Column Heading |
|---------------------------|--|--|
| percent-all-trunks-busy   | The percent of time all the trunks in a specified trunk group were busy during a specified period/day. Timing for a call begins when the last trunk is seized. | Trunk Group: % ALL BUSY                |
| percent-trunks-maint-busy | The percent of time trunks were busied out for maintenance during a specified period/day.  | Trunk Group: % TIME MAINT              |
| trunk-group-name          | The name administered for a specific trunk group.  | Trunk Group: Trunk Group Name          |
| trunk-group-number        | The number administered for a specific trunk group.  | Trunk Group: Trunk Group Number        |
| trunks-in-use             | The number of trunks currently in use (not idle).  | None                                   |
| trunks-maint-busy         | The number of trunks currently busied out for maintenance.   | None                                   |

## Considerations

Some VuStats data is accumulated for an agent's login session. This shift data clears either at midnight or the next time the agent logs in depending upon how the system is administered. If the data clears at login and agents log out to go to lunch, the system clears their accumulated data when they log back in after lunch.

To accumulate a full day's statistics, you can require agents and supervisors to keep a running total of all their login sessions, or, to avoid this, use historical data, require agents to use AUX work mode when temporarily unavailable, or administer the system to clear shift data at midnight.

## Interactions

---

- **BCMS**

You must have BCMS activated to receive BCMS reports. VuStats displays data collected by BCMS, but BCMS need not be enabled for you to use VuStats.
- **Call Prompting**

When Call Prompting digits are displayed, VuStats is canceled. When an agent reactivates VuStats, the VuStats display overwrites the Call Prompting display.
- **Call Work Codes (CWC)**

The CWC-display prompt suspends VuStats, so when the CWC prompt is removed, the VuStats display reappears.

If VuStats is activated while a CWC is being entered (that is, the pound (#) sign is not yet dialed), the CWC display is overwritten. The CWC must be reentered.
- **Change skills**

An agent changing skills automatically cancels VuStats. Display of the new skills overwrites the VuStats display. When the agent reactivates VuStats, the VuStats display overwrites the new skills display.
- **CMS**

Moving an agent from one split or skill to another does not affect the ID assigned to the vu-display button.

If an agent is moved from one split or skill to another, the system does not associate VuStat buttons from the agent's previous split or skill to the new split or skill. Therefore if you must frequently move agents between splits or skills, do not associate agents' VuStats buttons with a specific split or skill. Instead, associate the VuStats button with the agent format (without an ID) on each agent's voice terminal and use a split reference to view the agent's split/skill.
- **EAS-PHD**

When you have EAS-PHD enabled, VuStats can provide statistical data for all twenty skills. However, agent statistics by skill (agent or agent-extension object types) are available only for the current interval or for the "shift-acd-calls" and "shift-average-acd-talk-time" data types.
- **Integrated Directory**

If an agent activates Integrated Directory, VuStats is automatically cancelled. The Integrated Directory display overwrites the VuStats display and the VuStats button extinguishes. When VuStats is reactivated, the VuStats display overwrites the Integrated Directory display.

- Queue-Status Indications

The queue-status button display automatically cancels VuStats. When VuStats is reactivated, the VuStats display overwrites the queue-status display.

- Reason Codes

Using certain VuStats data types, you can report real-time and historical AUX work mode time by Reason Code or AUX work mode time summed for each Reason Code.

The Reason Codes display prompt suspends VuStats; when the Reason Codes prompt is removed, the VuStats display reappears.

- Service Observing

On terminals with a 1-line display, the Service Observing button display automatically cancels VuStats. When VuStats is reactivated, the VuStats display overwrites the Service Observing display.

# Call Center Forms

## Agent LoginID

---

This form is used to administer Agent LoginIDs for the Expert Agent Selection feature.

### Administration Commands

---

Use the following administration commands to administer the Agent LoginID form.

| Action  | Object        | Qualifier <sup>1</sup>                         |
|---------|---------------|--|
| add     | agent-loginid | xxxxx (extension) or "next"                    |
| change  | agent-loginid | xxxxx (extension)                              |
| display | agent-loginid | xxxxx (extension) ['print' or 'schedule']      |
| remove  | agent-loginid | xxxxx (extension)                              |
| list    | agent-loginid | ['staffed'  'unstaffed' ['name' x]['aas' y/n]] |

1. Brackets [ ] indicate the qualifier is optional. Single quotes ( ' ' ) indicate the text inside the quote must be entered exactly as shown or an abbreviated form of the word may be entered.

### Form Instructions

---

Make assignments as required for the following fields on the form:

- **Login ID** — Display-only field. Contains the identifier for the Logical Agent as entered on the command line.
- **Name** — Enter up to a 27-character string naming the agent. Any alpha-numeric character is valid. Default is blank.
- **TN** — Enter the Tenant Partition number. Default is "1."
- **COR** — Enter the Class of Restriction (from 0 to 95) for the agent. Default is 1.
- **Coverage Path** — Enter the number of the Coverage Path used by calls to the LoginID or leave blank (default). This is used when the agent is logged out, busy, or does not answer.
- **Security Code** — Enter the 4-digit security code (password) for the Demand Print messages feature. This field may be blank (default).
- **Direct Agent Skill** — Enter the number of the skill that is used to handle Direct Agent calls.
- **Call Handling Preference** — Choices are **skill-level**, **greatest-need**, and **percent-allocation**. When calls are in queue and an agent becomes available, "skill-level" delivers the oldest, highest priority call waiting for

the agent's highest level skill. "Greatest-need" delivers the oldest, highest priority call waiting for any of the agent's skills. "Percent-allocation" is a new call selection method available only with Lucent's CentreVu<sup>®</sup> Advocate software. For more information, please see the *CentreVu<sup>®</sup> Advocate User Guide* (585-215-855).

- **Service Objective** — This field is displayed only when the call handling preference is **greatest-need** or **skill-level**. Service Objective is a new feature that is part of Lucent's CentreVu<sup>®</sup> Advocate software. For more information, please see the *CentreVu<sup>®</sup> Advocate User Guide* (585-215-855).
- **Direct Agent Calls First** (not shown) — This field replaces the *Service Objective* field when **percent-allocation** is entered in the *Call Handling Preference* field. Percent allocation is only available with Lucent's CentreVu<sup>®</sup> Advocate software. For more information, please see the *CentreVu<sup>®</sup> Advocate User Guide* (585-215-855).
- **AAS** — Enter "y" if this extension will be used as a port for an Auto Available Split/Skill. Default is "n."



**WARNING:**

*Entering "y" in the AAS field clears the password and requires execution of the "remove agent-loginid" command. To set AAS to "n", this logical agent must be removed then re-added.*



**WARNING:**

*This option is intended for switch adjunct equipment ports only, not human agents.*

- **AUDIX** — Enter "y" if this extension will be used as a port for an AUDIX. Default is "n."



**NOTE:**

The AAS and AUDIX fields cannot both be "y".

- **LWC Reception** — Enter where LWC messages will be stored for this Agent LoginID. For R5r configurations, valid entries are "audix", "msa" "spe" (default), and "none". For R5si configurations, valid entries are "audix", "msa-spe" (default), and "none."
- **Port Extension** (not shown) — Only displayed if either the AAS or AUDIX field is "y". Enter the assigned extension for the AAS or AUDIX port. This extension cannot be a VDN or an Agent LoginID.
- **AUDIX Name for Messaging** — Only applicable to R5r configurations. Enter the name of the AUDIX used for LWC Reception and/or the name of the AUDIX that provides coverage for this Agent LoginID or leave blank (default).



- **Messaging Server Name for Messaging** — Only applicable to R5r configurations. Enter the name of the Messaging Server used for LWC Reception and/or the name of the Messaging Server that provides coverage for this Agent LoginID or leave blank (default).
- **LoginID for ISDN Display** — Enter “y” if the Agent LoginID CPN and Name field is to be included in ISDN messaging over network facilities. In this case, the physical station extension CPN and Name is sent. Default is “n.”
- **Password** — Only displayed if both the AAS and AUDIX fields are “n”. Enter up to nine digits as the password the Agent must enter upon login. Valid entries are the digits 0 through 9. The minimum number of digits that must be entered in this field is specified in the Minimum Agent-LoginID Password Length field on the Feature-Related System Parameters form.



**NOTE:**

Values entered into this field will not be echoed to the screen.

- **Password (enter again)** — Only displayed if both the AAS and AUDIX fields are “n.” Reenter the same password exactly as it was entered in the Password field.



**NOTE:**

Values entered into this field will not be echoed to the screen.

- **Auto Answer** — Valid entries are **all**, **acd**, **none**, and **station**. When Expert Agent Selection is optioned, the agent’s auto answer setting will apply to the station where the agent logs in. If the auto answer setting for that station is different, the agent’s setting will override the station’s.

The entries **all**, **acd**, and **none** have the same effect as the corresponding entries on the Station form. Enter **all** to allow all calls (ACD and non-ACD) terminated to the agent to be cut through immediately. Enter **acd** to allow only ACD split /skill calls and direct agent calls to auto answer. If this field is **acd**, Non-ACD calls terminated to the agent ring audibly. Enter **none** (default) to cause all calls terminated to this agent to receive an audible ringing treatment. Enter **station** if you want auto answer for the agent to be controlled by the auto answer field on the Station form.

- **SN (Skill Number)** — Enter the Skill Hunt Group(s) that this agent handles. The same skill may not be entered twice. If EAS-PHD is not optioned, up to 4 skills can be entered. If EAS-PHD is optioned, up to 20 skills can be entered.
- **RL (Reserve Level)** — Enter the reserve level (if any) assigned to this agent with the Service Level Supervisor feature. Service Level Supervisor is available as part of Lucent’s CentreVu<sup>®</sup> Advocate software. For more information, please see the *CentreVu<sup>®</sup> Advocate User Guide* (585-215-855).

- **SL (Skill Level)** — Enter the priority level that each skill has for this particular agent. If EAS-PHD is not optioned, 2 priority levels are available. If EAS-PHD is optioned, 16 priority levels are available. In releases prior to R3V5, level 1 was the primary skill and level 2 was the secondary skill.
- **PA (Percent Allocation)** — This field is displayed only when the call handling preference is **percent-allocation**. Percent Allocation is available as part of Lucent's CentreVu<sup>®</sup> Advocate software. For more information, please see the *CentreVu<sup>®</sup> Advocate User Guide* (585-215-855).

```

add agent-loginID 9011                                     Page 1 of 1
                                AGENT LOGINID

Login ID: 9011_                                           AAS? _
Name: _____                                         AUDIX? _
TN: 1_                                                    LWC Reception: msa-spe
COR: 1                                                    AUDIX Name for Messaging: _____
Coverage Path: _____ Messaging Server Name for Messaging: _____
Security Code: _____ LoginID for ISDN Display? n
Direct Agent Skill: _____ Password: _____
Call Handling Preference: skill-level                      Password (enter again): _____
Service Objective? _                                     Auto Answer: _____

SN  RL  SL  PA      SN  RL  SL  PA      SN  RL  SL  PA      SN  RL  SL  PA
1:  _  _  _  _      6:  _  _  _  _      11: _  _  _  _      16: _  _  _  _
2:  _  _  _  _      7:  _  _  _  _      12: _  _  _  _      17: _  _  _  _
3:  _  _  _  _      8:  _  _  _  _      13: _  _  _  _      18: _  _  _  _
4:  _  _  _  _      9:  _  _  _  _      14: _  _  _  _      19: _  _  _  _
5:  _  _  _  _     10: _  _  _  _      15: _  _  _  _      20: _  _  _  _

WARNING: Agent must log in again before skill changes take effect
    
```

Screen 9-1. Agent LoginID Form

### Implementation Notes

The Port Extension field is only displayed if either the AAS or AUDIX field is "y".

The AUDIX Name for Messaging and Messaging Server Name for Messaging fields are only displayed for R5r configurations.

The Password and Password (enter again) fields are only displayed when both the AAS and AUDIX fields are "n".

## Best Service Routing (BSR) Application Plan

---

Use this form to identify the remote locations used in each BSR application.



**NOTE:**

For an explanation of BSR application plans see [“Best Service Routing™” on page 9-44.](#)

### Administration Commands

---

Use the following administration commands to administer the BCMS/VuStats Login ID form. Valid application numbers are 1–255.

| Action            | Object               | Qualifier <sup>1</sup>             |
|-------------------|----------------------|------------------------------------|
| add               | best-service-routing | xxx (application number) or 'next' |
| change            | best-service-routing | xxx (application number)           |
| display           | best-service-routing | xxx (application number)           |
| remove            | best-service-routing | xxx (application number)           |
| list <sup>2</sup> | best-service-routing |                                    |

1. Brackets [ ] indicate the qualifier is optional. Single quotes ( ' ' ) indicate the text inside the quote must be entered exactly as shown or an abbreviated form of the word may be entered.
2. The command “list best-service-routing” displays the List Best Services Routing Applications form. This is a display-only form and is shown below.

### Form Instructions

---

Make assignments as required for the following fields on the form:

- **Application Number**—This display-only field shows the identifying number of the plan you’re working with. Numbered from 1 to 255.
- **Application Name**—Give the application plan a name with up to 15 characters.
- **Location Number**—One plan may have 1–255 locations. Location numbers are identifiers, and therefore need not be in sequential order. For example, you could assign locations with the identifiers 1, 3, 14 and 89 to one application plan.



```
list best-service-routing
      BEST SERVICE ROUTING APPLICATIONS

      Number           Name
      xxx             International
      xxx             Tech Support
      xxx             Sales
```

**Screen 9-3. List Best Service Routing Applications Form**

## BCMS/VuStats Login ID

---

If you want to monitor call activity by agent login IDs, and if the "BCMS/VuStats Login ID" field on the System-Parameters Customer-Options form is set to "y" but the EAS feature is not optioned, the administrator uses this form to administer valid logins.

You do not have to enter names. If you do not use names with the login IDs, the data you receive from BCMS and/or VuStats defaults to "ID xxxxxxxx" where "xxxxxxx" is the login ID.

### NOTE:

Only agents using one of the administered login IDs can successfully log in to a split measured by BCMS.

## Administration Commands

---

Use the following administration commands to administer the BCMS/VuStats Login ID form.

| Action  | Object                 | Qualifier <sup>1</sup> |
|---------|------------------------|------------------------|
| add     | bcms/vustats login IDs |                        |
| change  | bcms/vustats login IDs | [login ID]             |
| display | bcms/vustats login IDs | [login ID]             |
| list    | bcms/vustats login IDs | [login ID] count X     |

---

1. Brackets [ ] indicate the qualifier is optional.

## Form Instructions

---

Make assignments as required for the following fields on the form:

- **Login ID** — A number up to nine digits that an agent must enter to be measured in a split by BCMS. The login IDs are restricted to up to five digits if you are using EAS. The system validates each login ID. If you enter a duplicate login ID, the system displays an error message and places the cursor at the duplicate field. Also, the login ID must be the same length as the number in the "ACD Login Identification Length" field on the Feature-Related System-Parameters form. If the login ID you enter does not match the length specified in the "ACD Login Identification Length" field, the system displays an error message and places the cursor at the field that is incorrect.



**NOTE:**

The administered login length may change to another value, but doing so changes the allowed length for all IDs entered on this form. Before agents with logins that do not match the administered login length can log on, you must readminister either the ACD login identification length to fit the existing logins or change the logins to match the ACD login identification length.

- **Name** — A name associated with the login ID (optional).

```
change bcms/vu-stats login IDs                                     Page 1 of x
                                                                    BCMS/VU-STATS LOGIN IDS
Assigned Numbers: 300 of 400
  Login Id   Name                               Login Id   Name
  1: _____
  2: _____
  3: _____
  4: _____
  5: _____
  6: _____
  7: _____
  8: _____
  9: _____
 10: _____
 11: _____
 12: _____
 13: _____
 14: _____
 15: _____
 16: _____
 17: _____
 18: _____
 19: _____
 20: _____
 21: _____
 22: _____
 23: _____
 24: _____
 25: _____
 26: _____
 27: _____
 28: _____
 29: _____
 30: _____
 31: _____
 32: _____
```

Screen 9-4. BCMS/VuStats Login IDs Form

### Implementation Notes

The form appears only two pages (64 IDs) at a time. If you are adding login IDs, you can fill two pages and then reissue the command to fill an additional two pages, and so on. If you are changing or displaying login IDs, the system displays two pages of login IDs beginning with the ID you specified; if you did not specify a login ID when you issued the command, the display begins with the first login ID. The **list** command lists all login IDs and may run to 63 pages.

## Call Center System Parameters

Call Center System Parameters are listed on pages 7 and 8 of the Feature-Related System Parameters form. They are duplicated here for your convenience.

### Page 7 of the form

```
CALL CENTER SYSTEM PARAMETERS                                     Page 7 of 8

EAS
  Expert Agent Selection (EAS) Enabled? n
  Minimum Agent-LoginID Password Length:
  Direct Agent Announcement Extension: _____ Delay: ____
  Message Waiting Lamp Indicates Status For: station

VECTORIZING
  Converse First Data Delay: 0           Second Data Delay: 2
  Converse Signaling Tone (msec): 100    Pause (msec): 70_
  Prompting Timeout (secs): 10
  Interflow-qpos EWT Threshold: 2

SERVICE OBSERVING
  Service Observing Warning Tone? n

ASAI
  Call Classification After Answer Supervision? n   Send UCID to ASAI? n
```

### Screen 9-5. Feature-Related System Parameters form (page 7 of 8)

EAS parameters:

- **Expert Agent Selection (EAS) Enabled** — Only displays if `Expert Agent Selection (EAS)` on the System-Parameters Customer-Options form is `y`. Enter `y` to enable Expert Agent Selection. To enable this field, either no ACD or vectoring hunt groups may exist or, existing ACD or vectoring hunt groups must be "skilled." Default is `n`.
- **Minimum Agent-LoginID Password Length** — Only displays if `Expert Agent Selection (EAS)` on the System-Parameters Customer-Options form is `y`. Enter the minimum number of digits that must be administered as an EAS Agent's LoginID password. Valid entries are `0` through `9` or blank. Entering a `0` or blank indicates no password is required. Default is blank.
- **Direct Agent Announcement Extension** — Only displays if `Expert Agent Selection (EAS)` or `ASAI` on the System-Parameters Customer-Options form is `y`. Enter a valid announcement extension (consistent with the dial plan).



- **Direct Agent Announcement Delay** — Only displays if `Expert Agent Selection (EAS)` or `ASAI` on the `System-Parameters Customer-Options` form is **y**. Enter the number of seconds (**0** to **99**) the caller will hear ringback before the Direct Agent Announcement is heard by the calling party.
- **Message Waiting Lamp Indicates Status For** — Only displays if `Expert Agent Selection (EAS)` on the `System-Parameters Customer-Options` form is **y**. If `Expert Agent Selection (EAS) Enabled` is **y**, you can enter either **station** or **loginID**, otherwise you can only enter **station**.

Vectoring parameters:

- **Converse First Data Delay/Second Data Delay** — Only displays if `Vectoring (Basic)` on the `System-Parameters Customer-Options` form is **y**. The `First Data Delay` prevents data from being outpulsed (as a result of a converse vector step) from the system to a voice response unit (VRU) before the unit is ready. The delay commences when the VRU port answers the call. Enter the number of seconds (**0** to **9**) for the delay. Default is **0**. The `Second Data Delay` is used when two groups of digits are being outpulsed (as a result of a converse vector step) from the system to the VRU. The `Second Data Delay` prevents the second set from being outpulsed before the VRU is ready. The delay commences when the first group of digits has been outpulsed. Enter the number of seconds (**0** to **9**) for the delay. Default is **2**.
- **Converse Signaling Tone/Pause** — Only displays if `Vectoring (Basic)` and `DTMF` on the `System-Parameters Customer-Options` form are **y**. In the `Signaling Tone` field, enter the length in milliseconds of the digit tone for digits being passed to a voice response unit (VRU). In the `Pause` field, enter the length in milliseconds of the delay between digits being passed. The optimum timers for the VRU are a 100 msec tone and 70 msec pause.

Values entered in the `Tone/Pause` fields are rounded up or down depending upon the type of circuit pack used to outpulse the digits.

- **TN742B or later suffix analog board** — Tone and pause round up or down to the nearest 25 msecs. For example a 130 msec tone rounds down to 125 msecs, a 70 msec pause rounds up to 75 msec for a total of 200 msecs per tone.
- **TN464F, TN767E or later suffix DS1 boards** — Tone and pause round up to the nearest 20 msecs. For example a 130 msec tone rounds up to 140 msecs, a 70 msec pause rounds up to 80 msecs for a total of 220 msecs per tone.

If a circuit pack has been used for end-to-end signalling to the VRU, and has then been used to send digits to a different destination, the VRU timers may stay in effect. To reset your timers to the system default, pull and reseat the circuit pack.

- **Prompting Timeout (secs)** — Only displays if `Vectoring (Prompting)` on the System-Parameters Customer-Options form is **y**. Enter the number of seconds, from **4** to **10** (default), before the Collect Digits command times out for callers using rotary dialing.
- **Interflow-qpos EWT Threshold** — Part of enhanced Look-Ahead Interflow. Any calls predicted to be answered before this threshold will not be interflowed (therefore saving CPU resources). Enter the number of seconds for this threshold. The default is 2 seconds.

Service Observing parameters:

- **Service Observing Warning Tone** — `Service Observing (Basic)` on the System-Parameters Customer-Options form must be **y** before this field may be administered. Enter **y** to assign a warning tone to be given to voice terminal users and calling parties whenever their calls are being monitored using the Service Observing feature. Default is **n**.



**NOTE:**

The use of Service Observing features may be subject to federal, state, or local laws, rules or regulations or require the consent of one or both of the parties to the conversation. Customers should familiarize themselves and comply with all applicable laws, rules, and regulations before using these features.

ASAI parameters

- **Call Classification After Answer Supervision?** — For use with ASAI Outbound Call Management (OCM). Enter **y** to force the switch to rely on the network to provide answer/busy/drop classification to the switch. After the call has been answered, a call classifier can be added to perform answering machine, modem and voice answering detection. Enter **n** for standard operation.
- **Send UCID to ASAI?** — Enter **y** to enables transmission of Universal Call ID (UCID) information to ASAI. Enter **n** (default) to prevent transmission of UCID information to ASAI.

## Page 8 of the form

Page 8 of 8

CALL CENTER SYSTEM PARAMETERS

AGENT AND CALL SELECTION

MIA Across Splits or Skills? n  
ACW Agents Considered Idle? y  
Call Selection Measurement: current-wait-time

REASON CODES

Aux Work Reason Code Type: none  
Logout Reason Code Type: none

CALL MANAGEMENT SYSTEM

Adjunct CMS Release:  
ACD Login Identification Length: 0  
BCMS/VuStats Measurement Interval: hour  
BCMS/VuStats Abandon Call Timer (seconds):  
Validate BCMS/VuStats Login IDs? n  
Clear VuStats Shift Data: on-login

### Screen 9-6. Feature-Related System Parameters form (page 8 of 8)

#### Agent and Call Selection Parameters:

- **MIA Across Splits or Skills?** — Enter **y** to remove an agent from the MIA queue for all the splits/skills/hunt groups that he or she is available in when the agent answers a call from any of his or her splits/skills/hunt groups. The default is **n**.
- **ACW Agents Considered Idle?** — Enter **y** (default) to have agents who are in After Call Work included in the Most-Idle Agent queue. Enter **n** to exclude ACW agents from the queue.
- **Call Selection Measurement** — Valid entries are **current-wait-time** (default) and **predicted-wait-time**. This field determines how DEFINITY ECS selects a call for an agent when the agent becomes available and there are calls in queue. Current Wait Time selects the oldest call waiting for any of the agent's skills. Predicted Wait Time is a feature of CentreVu<sup>®</sup> Advocate. For more information, please see the *CentreVu<sup>®</sup> Advocate User Guide* (585-215-855).

#### Reason Codes Parameters:

- **Aux Work Reason Code Type** — Enter **none** if you do not want an agent to enter a Reason Code when entering AUX work. Enter **requested** if you want an agent to enter a Reason Code when entering AUX mode but do not want to force the agent to do so. Enter **forced** to force an agent to enter a Reason Code when entering AUX mode. To enter **requested** or **forced**, the Reason Codes and EAS on the System-Parameters Customer-Option form must be **y**.

- **Logout Reason Code Type** — Enter **none** if you do not want an agent to enter a Reason Code when logging out. Enter **requested** if you want an agent to enter a Reason Code when logging out but do not want to force the agent to do so. Enter **forced** to force an agent to enter a Reason Code when logging out. Enter **forced** to force an agent to enter a Reason Code when entering AUX mode. To enter **requested** or **forced**, the `Reason Codes` and `EAS` on the System-Parameters Customer-Option form must be **y**.

Call Management System Parameters:

- **Adjunct CMS Release** — Specifies the release of the CMS adjunct used with the system. For CMS, this field cannot be blank. Default is blank.
- **ACD Login Identification Length** — Enter the number of digits (**0** through **9**) for an ACD Agent Login ID if `Expert Agent Selection (EAS)` on the System-Parameters Customer-Options form is **n**. Default is **0**. If `BCMS/VuStats Login IDs` is **y**, the ACD Login ID length must be greater than 0. This field identifies an ACD agent to CMS. The number you enter in this field must equal the number of characters in the agent's login ID. For CMS, this field cannot be 0.
- **BCMS/VuStats Measurement Interval** — You can enter **half-hour** or **hour** (default) for polling and reporting measurement data if the `BCMS (Basic)` and/or the `VuStats` on the System-Parameters Customer-Options form is **y**. If neither of these features is optioned, and if you enter a value in the `BCMS Measurement Interval` field, the system displays the following error message:

**<value> cannot be used; assign either BCMS or VuStats first**

If you receive this message, see your Lucent Technologies representative to turn on `BCMS (Basic)` and/or `VuStats` on the System-Parameters Customer-Options form.

There are a maximum of 25 time slots available for measurement intervals. If **hour** is specified, an entire day of traffic information will be available for history reports; otherwise, only half a day will be available. This does not affect daily summaries as they always reflect traffic information for the entire day. The interval may be changed at any time, but will not go into effect until the current interval completes.

- **BCMS/VuStats Abandon Call Timer (seconds)** — Enter **none** or **1–10** to specify the number of seconds for calls to be considered abandoned. Calls with talk time that is less than this number (and that are not held) are tracked by BCMS and displayed by VuStats as ABAND calls.
- **Validate BCMS/VuStats Login IDs** — Enter **n** to allow entry of any ACD login of the proper length. Enter **y** to allow entry only of login-IDs that have been entered on the BCMS Login-ID form.
- **Clear VuStats Shift Data** — Enter **on-login** to clear shift data for an agent when the agent logs in. Enter **at-midnight** to clear shift data for all agents at midnight.

## Call Vector

This form programs a series of commands that specify how to handle calls directed to a Vector Directory Number (VDN). Refer to *DEFINITY Enterprise Communications Server Release 5 Call Vectoring/EAS Guide* for additional information.

### Administration Commands

Use the following commands to administer the Call Vector form.

| Action              | Object | Qualifier <sup>1</sup>                        |
|---------------------|--------|---|
| change <sup>2</sup> | vector | 1-MAX   |
| display             | vector | 1-MAX ['print' or 'schedule']                 |
| list                | vector | 1-MAX ['count' 1-MAX] ['print' or 'schedule'] |

1. Brackets [ ] indicate the qualifier is optional. Single quotes ( ' ' ) indicate the text inside the quote must be entered exactly as shown or an abbreviated form of the word may be entered. MAX is the maximum number available in your system configuration.
2. Do not change a call vector while it is processing a call. It is recommended to add a new vector with the Call Vector form, and then use the Vector Directory Number form to point an existing VDN to the new vector.

### Form Instructions

Page 1 of 3

CALL VECTOR

Number: \_\_\_\_\_ Name: \_\_\_\_\_ Multimedia? n Lock? n

Basic? y EAS? n G3V4 Enhanced? y ANI/II-Digits? y ASAI Routing? n  
 Prompting? y LAI? n G3V4 Adv Route? y CINFO? y BSR? n

01 \_\_\_\_\_  
 02 \_\_\_\_\_  
 03 \_\_\_\_\_  
 04 \_\_\_\_\_  
 05 \_\_\_\_\_  
 06 \_\_\_\_\_  
 07 \_\_\_\_\_  
 08 \_\_\_\_\_  
 09 \_\_\_\_\_  
 10 \_\_\_\_\_  
 11 \_\_\_\_\_

## Form Instructions

---

Page 2 of 3

CALL VECTOR

12 \_\_\_\_\_  
13 \_\_\_\_\_  
14 \_\_\_\_\_  
15 \_\_\_\_\_  
16 \_\_\_\_\_  
17 \_\_\_\_\_  
18 \_\_\_\_\_  
19 \_\_\_\_\_  
20 \_\_\_\_\_  
21 \_\_\_\_\_  
22 \_\_\_\_\_

Screen 9-8. Call Vector Form (Page 2 of X)

Page 3 of 3

CALL VECTOR

23 \_\_\_\_\_  
24 \_\_\_\_\_  
25 \_\_\_\_\_  
26 \_\_\_\_\_  
27 \_\_\_\_\_  
28 \_\_\_\_\_  
29 \_\_\_\_\_  
30 \_\_\_\_\_  
31 \_\_\_\_\_  
32 \_\_\_\_\_

Screen 9-9. Call Vector Form (Page 3 of X)

Make assignments as required for the following fields on the form:

- **Number** — Display-only field when the form is accessed using a **change** or **display** administration command. Enter a vector number when completing a paper form.
- **Name** — Enter up to 27 alphanumeric characters to represent the vector name. This is an optional field. Default is blank.
- **Multimedia** — Indicates whether the vector should receive early answer treatment for multimedia calls. This only applies if Multimedia Call Handling is enabled. If you expect this vector to receive multimedia calls, set this field to **y**. Valid values are **y** or **n**. If this value is **y**, the call is considered to be answered at the start of vector processing, and billing for the call starts at that time. See [“Multimedia Call Handling” on page 11-30](#) for more information.

- **Lock**—This field controls access to the vector from Lucent CentreVu<sup>®</sup> products. Enter **n** to give CentreVu<sup>®</sup> CMS and CentreVu<sup>®</sup> Control Center users the ability to administer this vector from these client programs. Enter **y** if you do not want this vector to be accessible to these client programs. Locked vectors can only be displayed and administered through the SAT or a terminal emulator.

 **NOTE:**

Always lock vectors that contain secure information (for example, access codes).

- **Basic** — Display-only field. Indicates whether the `Vectoring (Basic)` option is enabled on the System-Parameters Customer-Options form. Valid values are **y** or **n**.
- **EAS** — Display-only field. Indicates whether the `Expert Agent Selection (EAS)` option is enabled on the System-Parameters Customer-Options form. Valid values are **y** or **n**.

 **NOTE:**

When `Expert Agent Selection (EAS)` is enabled, the help messages and error messages associated with this form will reflect a terminology change from "Split" to "Skill". In addition, the vector commands entered also will be affected by this terminology change (for example, *check backup split* becomes *check backup skill* when EAS is enabled).

- **G3V4 Enhanced** — Display-only field. Indicates whether you can use G3V4 Enhanced Vector Routing commands and features.
- **ANI/II-Digits** — Display-only field. Indicates whether you can use ANI and II-Digits Vector Routing Commands. ANI/II-Digits Routing requires that `G3V4 Enhanced` be set to **y**.
- **ASAI Routing** — Display-only field. Indicates whether or not the `CallVisor Adjunct/Switch Applications Interface (ASAI) Routing` option is enabled on the System-Parameters Customer-Options form. Valid values are **y** or **n**.
- **Prompting** — Display-only field. Indicates whether the `Vectoring (Prompting)` option is enabled on the System-Parameters Customer-Options form. Valid values are **y** or **n**.
- **LAI** — Display-only field. Indicates whether Look-Ahead Interflow is enabled.
- **G3V4 Adv Route** — Display-only field. Indicates whether you can use the G3V4 Advanced Vector Routing commands.
- **CINFO** — Display-only field. Indicates whether the `Vectoring (CINFO)` option is enabled on the System-Parameters Customer-Options form. Valid values are **y** or **n**.

- **BSR**—A **y** in this display-only field indicates that the Vectoring (Best Service Routing) option is enabled on the System-Parameters Customer-Options form. Thus, you can use BSR commands and command elements in your vectors. An **n** indicates that the BSR option is not enabled.
- **01 through XX** — Enter vector commands as required (up to the maximum allowed in your configuration).



## Reason Code Names

---

Use the Reason Code Names form to assign names to Reason Codes. You can assign a different name to each Reason Code for Aux Work and for Logout.

### Administration Commands

---

Use the following administration commands to access the Reason Code Names form.

| Action  | Object            |
|---------|-------------------|
| display | reason-code-names |
| change  | reason-code-names |

### Form Instructions

---

Make assignments as required for the following fields on the form.

- **Aux Work** — For each Reason Code enter the name to be associated with this Reason Code when the agent uses this Reason Code to enter Aux Work mode. Names can be up to ten characters long.
- **Logout** — For each Reason Code enter the name to be associated with this Reason Code when the agent uses this Reason Code to log out. Names can be up to ten characters long.

REASON CODE NAMES

|                      | Aux Work | Logout |
|----------------------|----------|--------|
| Reason Code 1:       | _____    | _____  |
| Reason Code 2:       | _____    | _____  |
| Reason Code 3:       | _____    | _____  |
| Reason Code 4:       | _____    | _____  |
| Reason Code 5:       | _____    | _____  |
| Reason Code 6:       | _____    | _____  |
| Reason Code 7:       | _____    | _____  |
| Reason Code 8:       | _____    | _____  |
| Reason Code 9:       | _____    | _____  |
| Default Reason Code: | _____    | _____  |

## SIT Treatment for Call Classification

---

This form is used to provide the capability of specifying the treatment of Special Information Tones (SITs) used for Outbound Call Management type calls with USA tone characteristics. The TN744 Call Classifier circuit pack ports are used to detect SITs. The TN744 is capable of detecting the following six SITs:

- SIT Ineffective Other
- SIT Intercept
- SIT No Circuit
- SIT Reorder
- SIT Vacant Code
- SIT Unknown
- AMD Treatment

### Administration Commands

---

Use the following administration commands to administer the SIT Treatment For Call Classification form. In some cases, just the most commonly used commands are shown. Refer to [Appendix B, "Administration Commands"](#), for a complete listing of all administration commands, the command structure, and the use of abbreviated command words when entering a command.

| Action  | Object        | Qualifier <sup>1</sup>  |
|---------|---------------|-------------------------|
| change  | sit-treatment | —                       |
| display | sit-treatment | ['print' or 'schedule'] |

- 
1. Brackets [ ] indicate the qualifier is optional. Single quotes ( ' ) indicate the text inside the quote must be entered exactly as shown or an abbreviated form of the word can be entered.

### Form Instructions

---

Make assignments as required for the following fields on the form:

In the field following each type of SIT, enter "answered" to specify that the call is classified as answered, and is therefore sent to an agent; or enter "dropped" to specify that the call is classified as not answered, and is therefore not sent to an agent.

- **SIT Ineffective Other** — Sample announcement following this SIT — "You are not required to dial a "1" when calling this number." Valid entries are "answered" and "dropped." Default is "dropped."

9 Call Center Forms

SIT Treatment for Call Classification

- **SIT Intercept** — Sample announcement following this SIT — “XXX-XXXX has been changed to YYY-YYYY, please make a note of it.” Valid entries are “answered” and “dropped.” Default is “answered.”
- **SIT No Circuit** — Sample announcement following this SIT — “All circuits are busy, please try to call again later.” Valid entries are “answered” and “dropped.” Default is “dropped.”
- **SIT Reorder** — Sample announcement following this SIT — “Your call did not go through, please hang up and dial again.” Valid entries are “answered” and “dropped.” Default is “dropped.”
- **SIT Vacant Code** — Sample announcement following this SIT — “Your call cannot be completed as dialed, please check the number and dial again.” Valid entries are “answered” and “dropped.” Default is “dropped.”
- **SIT Unknown** — A situation or condition that is unknown to the network is encountered. Valid entries are “answered” and “dropped.” Default is “dropped.”
- **AMD (Answering Machine Detected)** — An ASA1 adjunct can request AMD for a switch-classified call. If Answering Machine is detected, one of two treatments is specified. Valid entries are “dropped” and “connected.” Default is “dropped.”

AMD Treatment has two separately administrable subfields. Talk Duration is for full seconds and Pause Duration is for fractions of a second, separated by a display-only decimal point. Talk Duration defaults to 2.0 seconds and allows a range from 0.1 seconds to 5.0 seconds in increments of 0.1 seconds. Pause duration defaults to 0.5 seconds and allows a range from 0.1 seconds to 2.0 seconds in increments of 0.1 seconds.

```
SIT TREATMENT FOR CALL CLASSIFICATION
SIT Ineffective Other:  dropped
SIT Intercept:         answered
SIT No Circuit:       dropped
SIT Reorder:          dropped
SIT Vacant Code:     dropped
SIT Unknown:         dropped
AMD Treatment:        dropped
Pause Duration (seconds): 0.5
Talk Duration (seconds): 2.0
```

Screen 9-11. SIT Treatment For Call Classification Form

## Vector Directory Number

---

This form is used to define vector directory numbers (VDNs) for the Call Vectoring feature. A VDN is an extension number used to access a call vector. Each VDN is mapped to one call vector.

VDNs are software extension numbers (that is, not assigned to physical equipment). A VDN is accessed via direct dial CO trunks mapped to the VDN (incoming destination or night service extension), DID trunks, and LDN calls. The VDN may be Night Destination for LDN.

For more information, refer to the *DEFINITY Enterprise Communications Server Release 5 Call Vectoring/EAS Guide*.

### Administration Commands

---

Use the following administration commands to administer the Vector Directory Number form

| Action  | Object | Qualifier <sup>1</sup>   |
|---------|--------|--|
| add     | vdn    | xxxxx (extension number of VDN to be added) or 'next'                                |
| change  | vdn    | xxxxx (extension number of VDN to be changed)  |
| display | vdn    | xxxxx (extension number of VDN to be displayed) ['print' or 'schedule']              |
| list    | vdn    | xxxxx (extension number of VDN to be listed) ('count' 1-MAX) ['print' or 'schedule'] |
|         | vdn    | bsr xxx (number of a BSR application plan)   |
| remove  | vdn    | xxxxx (extension number of VDN to be removed)  |

1. Brackets [ ] indicate the qualifier is optional. Single quotes ( ' ) indicate the text inside the quote must be entered exactly as shown or an abbreviated form of the word can be entered. MAX is the maximum number available in your system configuration. Refer to *DEFINITY ECS Release 5 — System Description Pocket Reference*.

### Form Instructions

---

Make assignment as required for the following fields on the form:

- **Extension** — Enter the extension associated with the VDN when completing a paper form. The extension is a 1- to 5-digit number that starts with a valid first digit and length as defined by the System's dial plan. This is a display-only field when using an administration command such as add or change to access the form.

- **Name** — Enter up to a 27-character alphanumeric name that identifies the VDN. This is an optional field that need not contain any data. The name may be truncated on agents' displays depending on the application. When information is forwarded with an interflowed call, only the first 15 characters are sent.
- **Allow VDN Override?** — This entry affects the operation of an agent's display and certain options/data assigned to the VDN when a call is routed through several VDNs. If it is set to **n**, the name of this VDN appears on the agent's display and the VDN's AUDIX mail is accessed. If any subsequent VDNs are used to process this call, their names will not appear on the terminating display and the AUDIX mail for the original VDN is accessed. If the field is set to **y**, the name of the VDN appearing on the terminating display will depend on the administration and chaining of the subsequent VDNs and the AUDIX mail for the last VDN is accessed. Default is "n."

For Expert Agent Selection (EAS), if this field is **y** on the original VDN, the Skills of the new VDN will be used. If this field is **n** on the original VDN, the Skills of the original VDN will be used.

For Best Service Routing (BSR), if this field is **y** on the original VDN, the BSR Application and Available Agent Strategy of the new VDN will be used. If this field is **n** on the original VDN, the BSR Application and Available Agent Strategy of the original VDN will be used.

- **COR** — Enter a 1- to 2-digit number that specifies the class of restriction (COR) to be assigned the VDN. The default value is "1." The field cannot be blank and must have an entry in the range from 0 through 95.
- **TN** — Enter the Tenant Partition number. The default value is "1".
- **Vector Number** — Enter a 1- to 3-digit vector number that specifies a particular call vector that is accessed through the VDN. Valid entries are in the range from 1 through the maximum number allowed in your system configuration. The field cannot be blank.
- **AUDIX Name** — Only displayed for R5r and later configurations. If this VDN is associated with the AUDIX vector, enter the name of the AUDIX machine as it appears in the Adjunct Names form.
- **Messaging Server Name** — Only displayed for R5r configurations. If this VDN is associated with MSA, enter the name of the server as it appears in the Adjunct names form.
- **Measured** — Used to collect measurement data for this VDN. Valid entries are "internal," "external," "both," or "none." Data may be collected for reporting by BCMS or CMS. Default is "none."

 **NOTE:**

The BCMS feature must be enabled on the System-Parameters Customer-Options form for the Measured field to be set to "internal" or "both." In addition, the appropriate CMS release must be

administered on the Feature-Related System Parameters form if the field is being changed to “external” or “both.”

- **Acceptable Service Level (sec)** — Only displayed when the BCMS/VuStats Service Level option is enabled on the System-Parameters Customer-Options form and the Measured field is “internal” or “both.” Enter the number of seconds within which calls to this VDN should be answered. This will allow BCMS to print out a percentage of calls that were answered within the specified time. Valid entries are 0 through 9999 seconds. Default is blank.

The following field appears only if VDN of Origin Announcements is enabled on the System-Parameters Customer-Options form.

- **VDN of Origin Ann. Extension** — Enter the extension number of the VDN of Origin announcement. Default is none.
- **1st/2nd/3rd Skill** — Only displayed when Expert Agent Selection is enabled on the System-Parameters Customer-Options form. Enter the desired Skill numbers (or leave blank) in each field.
- **Return Destination** — The VDN extension number to which an incoming trunk call will be routed if it returns to vector processing after the agent drops the call.
- **VDN Timed ACW Interval** — When a value is entered in this field, an agent in auto-in work mode who receives a call from this VDN is automatically placed into After Call Work (ACW) when the call drops. Enter the number of seconds the agent should remain in ACW following the call. When the administered time is over, the agent automatically becomes available. This field has priority over the “Timed ACW Interval” field on the Hunt Group form.
- **BSR Application** — To use multi-site Best Service Routing with this VDN, enter a 1- to 3-digit number to specify an application plan for the VDN. This field only appears if Lookahead Interflow (LAI) and Vectoring (Best Service Routing) are enabled on the System Parameters Customer-Options form.
- **BSR Available Agent Strategy** — The available agent strategy determines how Best Service Routing identifies the “best” split or skill to service a call in an agent surplus situation. To use Best Service Routing with this VDN, enter an agent selection strategy in this field. Acceptable entries are 1st-found, UCD-LOA, UCD-MIA, EAD-LOA, and EAD-MIA.

This field only appears if Vectoring (Best Service Routing) is enabled on the System Parameters Customer-Options form.

Page 1 of 1

VECTOR DIRECTORY NUMBER

```

Extension: 50000
Name:
Allow VDN Override? n
COR: 59
TN: 1
Vector Number: 234
AUDIX Name:
Messaging Server Name:
Measured: none
Acceptable Service Level (sec):
VDN of Origin Annc. Extension: 301
1st Skill:
2nd Skill:
3rd Skill:

Return Destination:
VDN Timed ACW Interval:
BSR Application:
BSR Available Agent Strategy: 1st-found
    
```

**Screen 9-12. Vector Directory Number — Add/Change Form**

VECTOR DIRECTORY NUMBERS

| Name           | VDN   |      | Vec |    |     | Meas | Annc | Event |     |     |
|----------------|-------|------|-----|----|-----|------|------|-------|-----|-----|
|                | Ext   | Ovrd | COR | TN | Num |      |      | Adj   | 1st | 2nd |
| Tech Support   | 50000 | y    | 59  | 1  | 234 | none | 301  |       |     |     |
| Customer Serv. | 50001 | n    | 1   | 1  | 1   | none | 302  |       |     |     |
| New Orders     | 50002 | y    | 23  | 1  | 5   | none | 303  |       |     |     |
| Denver         | 50003 | y    | 23  | 1  | 123 | int  | 304  |       |     |     |
| San Francisco  | 50004 | y    | 39  | 1  | 123 | ext  | 305  |       |     |     |
| Chicago        | 50005 | y    | 12  | 1  | 123 | both | 306  |       |     |     |

**Screen 9-13. Vector Directory Numbers — List Form**

**Implementation Notes**

AUDIX Name and Messaging Server Name are only displayed for a R5r configuration.

The BCMS feature must have been optioned if the Measured field is set to "internal" or "both." In addition, the appropriate CMS release must be administered on the Feature-Related System Parameters form if the field is being changed to "external" or "both."

The 1st/2nd/3rd Skill fields are only displayed when Expert Agent Selection is enabled on the System-Parameters Customer-Options form.

The BCMS Acceptable Service Level (sec) field is only displayed if the BCMS Acceptable Service Level option is enabled on the System-Parameters Customer-Options form and the Measured field is "internal" or "both."

Data for the Orig Annc column appears only when VDN of Origin Announcement is enabled on the System-Parameters Customer-Options form.

To list all VDNs using the same BSR Application Plan, type the administration command **list VDN BSR xxx** (xxx is the number of the BSR Application Plan used by one or more VDNs).



## Vector Routing Table

---

This form is used to store “ani” or “digits” that you refer to in your “goto” vector steps. It is available to you only if the Vectoring (G3V4 Enhanced) field on the System-Parameters Customer-Options form is set to yes.

For more information, refer to [“Call Vectoring” on page 9-63](#) or to *DEFINITY Enterprise Communications Server Release 5 Call Vectoring /EAS Guide*.

### Administration Commands

---

You can use the commands listed in the table below to administer Vector Routing Tables. In addition, you can use the “List Usage” command to see the vectors and digit fields used by a Vector Routing Table.

| Action  | Object | Qualifier                              |
|---------|--------|--|
| add     | vrt    | 1 through x, or next                   |
| change  | vrt    | 1 through x, or next                   |
| display | vrt    | 1 through x, or next                   |
| remove  | vrt    | 1 through x, or next                   |
| list    | vrt    | none - all Routing Tables will display |

### Form Instructions

---

Make assignment as required for the following fields on the form:

- **Number** — This is the table number that you entered on the command line. It is a display only field.
- **Name** — Enter a 1 to 15-character alphanumeric table name. You may leave this field blank.
- **Sort?** — Enter “y” if you want the digit fields to be sorted. Default is “n.” If you elect not to sort the numbers, they will remain in the order that you entered them. If you elect to sort the number fields, they will be sorted as described below. Remember that leading zeros are significant. That means that 02 will sort ahead of a 2 followed by a space.
  - Any Plus signs (+) will sort first.
  - Any question marks (?) will sort second.
  - All numbers (0–9) will sort last.

- **Number (1-32)** — Enter a number. Entries in this field also can include the “+” and/or “?” wildcard. The “+” represents a group of digits. The “?” represents a single digit. The field is limited to 16 characters and these characters are restricted as follows:
  - You may enter only a plus sign (+), a question mark (?), or the numbers 0 through 9. No other entries are valid.
  - You may enter one plus sign (+) as either the first or last character in the number field. However, you cannot use this character as the sixteenth character of the number field.
  - You may use as many question marks (?) as you wish, anywhere in the number field.
  - You may not embed blanks in the number field.
  - You may leave the field entirely blank. If you leave the field blank DEFINITY ECS will store the entry as a null value.

Page 1 of 3

VECTOR ROUTING TABLE

Number: \_\_\_\_ Name: \_\_\_\_\_ Sort? n

|           |           |
|-----------|-----------|
| 1: _____  | 17: _____ |
| 2: _____  | 18: _____ |
| 3: _____  | 19: _____ |
| 4: _____  | 20: _____ |
| 5: _____  | 21: _____ |
| 6: _____  | 22: _____ |
| 7: _____  | 23: _____ |
| 8: _____  | 24: _____ |
| 9: _____  | 25: _____ |
| 10: _____ | 26: _____ |
| 11: _____ | 27: _____ |
| 12: _____ | 28: _____ |
| 13: _____ | 29: _____ |
| 14: _____ | 30: _____ |
| 15: _____ | 31: _____ |
| 16: _____ | 32: _____ |

Screen 9-14. Vector Routing Table Form (1 of 3)

## VuStats Display Format

---

Use the VuStats Display Format form to define the content and layout of information on VuStats voice terminal displays. The system has 50 different display formats; the first display is a predefined example format, which can be changed; displays 2 through 50 are blank. Each display format can contain up to ten data items. However, the amount of data to be displayed is limited to 40 characters, due to the physical limitations on display voice terminals.

### Administration Commands

---

Use the following administration commands to access the VuStats Display Format form.

| Action  | Object                 | Qualifier <sup>1</sup> |
|---------|------------------------|------------------------|
| change  | vustats-display-format | 1-50                   |
| display | vustats-display-format | 1-50                   |
| list    | vustats-display-format | 1-50 count ##          |

1. Specify a number from 1 to 50 to indicate the number of the display format to be to changed or displayed. "Count ##" is the number of display formats to list.

### Form Instructions

---

Enter the data as required for the following fields on the form:

- **Format Number** — This is the display format number you entered on the command line. It is a display only field and cannot be modified.
- **Next Format Number** — To link this display to another display, enter the number of the display format that should appear when a VuStats user presses the next button, or enter "none."
- **Data Field Character** — The character that will be used in the Format Description field to identify the position and length of each data field (see the Format Description field description below). The default is "\$." Enter another character if the "\$" is needed for fixed text in the Format Description field. Any character is valid except a space.
- **Number of Intervals** — If you intend to display interval-based historical data, specify the number of measurement intervals in this field. You can enter a number between 1 and 24. If you enter 24, and the BCMS measurement interval on the Feature-Related System Parameters form is set to 1 hour, you will receive information on the previous 24 hours. If the

BCMS measurement interval is set to half-hour, you will receive information on the previous 12 hours. You can also leave this field blank. If you do, you will receive information on the current interval.

- **Object Type** — The type of object for which data will be displayed. Enter one of the following values: “agent” (for staffed agents to view their own statistics), “agent-extension” (for other users to view agent statistics), “split” (default), “trunk-group,” or “vdn.”
- **Update Interval** — The interval, in seconds, between display updates. Enter one of the following values:

| Valid Input | Description  |
|-------------|--|
| no-update   | The display is not updated, and appears only for the interval specified in the Display Interval field                          |
| polled      | Updates the display hourly or half-hourly, based on the value in "BCMS Measurement Interval" (System-Parameters Features form) |
| 10          | Updates every 10 seconds   |
| 20          | Updates every 20 seconds   |
| 30          | Updates every 30 seconds, default value  |
| 60          | Updates every 1 minute   |
| 120         | Updates every 2 minutes  |

- **On Change** — Enter “y” to update the display whenever the agent’s state changes. The update on agent state change is in addition to the update as a result of the value entered in the Update Interval field. If “n” is entered, an update will only occur based on the Update Interval and not on the agent state change.
- **Display Interval** — The interval, in seconds, for which data is displayed if “no update” is entered in the Update Interval field. Enter one of the following values:

| Valid Input | Description  |
|-------------|--|
| Body        |  |
| 5           | Display clears after 5 seconds   |
| 10          | Display clears after 10 seconds, default value   |
| 15          | Display clears after 15 seconds  |
| 30          | Display clears after 30 seconds  |
| not-cleared | The display does not clear, and the data appears until the display is used for another operation or until you press the Normal button. |

- **Format Description** — The definition of the layout for the 40-character display. Specify the starting position and the length of the data items by entering, for each data field, an optional label for the field followed the appropriate number of data field characters (such as \$s). Each "\$" represents one character in the display. For example, if the data will be a maximum of five characters long (for example, to display 5-digit agent extensions), enter "\$\$\$\$\$."

 **NOTE:**

Some data types have preset maximum field length limits based on switch administration. For example, the data type "acceptable-service-level" is taken from the BCMS Acceptable Service Level field on the Hunt Group and Vector Directory Number forms; on this form, the field allows a maximum number of four characters. Therefore, for the acceptable-service-level, you should not create a VuStats display field that consists of more than four characters (that is, "\$\$\$\$"). Other data types have similar limits.

Field lengths for data items that appear as time must match the value in the Format field, which is discussed below. Remember to account for possible colons when the display will be in a time format.

Format descriptions can be all text (such as a message of the day) or they can be all data fields, in which case users will have to memorize the labels or use customer-provided overlays above or below the display.

 **NOTE:**

If the numeric data for a field is too large for the number of data field characters entered, the VuStats display will show asterisks instead of data. If name database items are too large for the number of data field characters, the VuStats display will truncate the data to fit the data field size. The split objective, as entered on the Hunt Group form, will display as asterisks if the information exceeds the data field size.

### Data Item Fields

On lines 1 through 10, beneath the Data Type field label enter data items for the display format. These data items are associated with the sets of data field characters in the Format Description field. Each data item is defined by one or more of the following fields: Data Type, Format, Period, Threshold, and Split Reference. Input for these fields is described in more detail below.

Enter each data item in the same order as data fields are defined in the Format Description field. For example, Line 1 of the Data Type field must contain the data item for the first data field (that is, the first set of \$s).

- **Data Type** — The data item to be included in the current display format. For a complete list of data types available for each object type, see "Tables of Data Types" on page 3-540.

- **Format** — The format for displaying the data type. The format is required only for a data type with a time value. Enter one of the following Format values.

| Valid Input | Description   | Minimum Input Length |
|-------------|---|----------------------|
| ccs         | Hundred call seconds (CCS) rounded to the nearest CCS | 1                    |
| h           | Hours rounded to the nearest hour                     | 1                    |
| h:mm        | Hours and minutes rounded to the nearest minute       | 4                    |
| h:mm:ss     | Hours, minutes, and seconds                           | 7                    |
| m           | Minutes rounded to the nearest minute                 | 1                    |
| m:ss        | Minutes and seconds                                   | 4                    |
| s           | Seconds   | 1                    |

- **Period** — Enter the measurement period for the data type. If the data type is historical data, you cannot leave this field blank. Valid entries are “day” (midnight to the current time), “interval” (the time specified in the “Number of Intervals” field), or blank. Refer to [“Tables of Required and Allowed Fields” on page 9-227](#) to determine if a measurement period is required for a particular Data Type.
- **Threshold** — The threshold field is always an optional field. It contains two subfields, the threshold comparator and the threshold value. The threshold value is used with the threshold comparator to determine if a threshold warning should be generated. A threshold warning is generated if the specified condition is met for one or more of the data items. If the specified condition is not met for any of the data items, then no threshold warning is generated. The threshold value can be any numeric value from 0 to 999. Valid threshold comparators are:
  - = (equal to)
  - <> (not equal to)
  - < (less than)
  - <= (less than or equal to)
  - > (greater than)
  - >= (greater than or equal to)

- **Ref** — A reference to a split/skill; this field does not appear unless the Object Type is either “agent” or “agent-extension.” This field is required only if the data type is an agent-related data type collected on a per-split basis or a split-related data type for one of the agent’s logged-in splits. Enter one of the following values:

- “Top” references the first-administered, highest-level skill for EAS agents, or the first split logged into for non-EAS agents.

 **NOTE:**

With EAS, the “top” skill for VuStats is the first administered, highest level skill measured “internally” or “both.” For CMS it is the first-administered, highest-level skill measured “externally” or “both.” Therefore, it is possible for the top skill to be a different number skill for CMS than it is for VuStats. To avoid this, measure all skills as “both.”

- “All” displays the combined data for all splits the agent is logged into.
- Any number from 1-20. The number represents a split to which the agent has logged in. For example, if the Ref field contains “1,” VuStats displays the data for the first split the agent logged into, if the Ref field contains “2,” VuStats displays the data for the second split the agent logged into, and so on.

VUSTATS DISPLAY FORMAT

Format Number: \_\_\_\_\_ Object Type: \_\_\_\_\_  
 Next Format Number: \_\_\_\_\_ Update Interval: \_\_\_\_\_ On Change? \_  
 Data Field Character: \_ Display Interval: \_\_\_\_\_  
 Number of Intervals: \_\_\_\_\_

Format Description: \_\_\_\_\_

|     | Data Type | Format | Period | Threshold | Ref   |
|-----|-----------|--------|--------|-----------|-------|
| 1:  | _____     | _____  | _____  | _____     | _____ |
| 2:  | _____     | _____  | _____  | _____     | _____ |
| 3:  | _____     | _____  | _____  | _____     | _____ |
| 4:  | _____     | _____  | _____  | _____     | _____ |
| 5:  | _____     | _____  | _____  | _____     | _____ |
| 6:  | _____     | _____  | _____  | _____     | _____ |
| 7:  | _____     | _____  | _____  | _____     | _____ |
| 8:  | _____     | _____  | _____  | _____     | _____ |
| 9:  | _____     | _____  | _____  | _____     | _____ |
| 10: | _____     | _____  | _____  | _____     | _____ |

Screen 9-15. VuStats Display Format — Blank Change/Display Form

[Screen 9-16](#) shows an example of a completed VuStats Display Format screen.

```

change display-format 11                                     Page 1 of 1
                   VUSTATS DISPLAY FORMAT
    Format Number: 11                                     Object Type: agent
    Next Format Number: 12                               Update Interval: 30       On Change? n
    Data Field Character: $
    Number of Intervals: 16

    Format Description: SPLIT=$$ ASL=$$ ASA=$$ PSL=$$$

    Data Type                Format  Period  Threshold  Ref
    1: split-number          s                interval  1
    2: split-acceptable-service-level
    3: split-average-speed-of-answer      interval  1
    4: split-percent-in-service-level     interval  1
    5:
    6:
    7:
    8:
    9:
    10:
    
```

**Screen 9-16. VuStats Display Format — Example Change/Display Form**

**List VuStats Display Format Screen**

A second VuStats Display Format screen is available with the **list** command. The purpose of this screen is to present the format of all, or a selected number, of VuStats displays. The List VuStats Display Format screen displays the Format Number, Next Format Number, Number of Intervals, Object Type, Update Interval, and Format Description fields, and all designated data items, including the Data Type, Format, Threshold, and Ref (split reference).

Use this screen to compare VuStats displays to each other. This “list” presentation is most helpful when trying to see how displays are linked to each other. The screen includes the Next field, which contains the number of the next display (if any) to which a display is linked.

[Screen 9-17](#) shows an example of the List VuStats Display Format screen. The fields for this screen are described below. Refer to the previous field descriptions in this section for more information.

**No** — Number. The unique identifying number of each display format.

**Next** — The number of the next display if the current display is linked to (followed by) another display format, or “none” if the current display format is not linked to another display format.

**Int** — Number of Intervals. The number of measurement intervals.

**Object Type** — The type of object for which data will be displayed.



**Update** — Update Interval. The time between display updates.

**Format Description** — The definition of the display's layout. The first line of the Format Description contains the text that precedes the data on a display plus the length of each data field (indicated by \$s). The succeeding lines of the Format Description identify the data items, in the order they are to appear. The data items are the actual measurements and other information that tell how agents, splits, vector directory numbers (VDNs), trunk groups, and the call center are performing. The data items are followed by the format (if any), which identifies how the data is to appear in the display, the period and threshold (if any), and the split reference (if any).

```

                                                    Page 1
VUSTATS DISPLAY FORMATS
No Next Int Object Type Update Format Description
1 none split 30 SPLIT=$$ WAITING=$$$ OLDEST=$$$$
  split-number
  calls-waiting
  oldest-call-waiting m:ss
2 none agent-extension on-change AGENT=$$$$ STATE=$$$$$$$$ TIME=$$$$$$$$
  agent extension
  agent state 1
  time-agent-entered-state 1

press CANCEL to quit -- press NEXT PAGE to continue
    
```

Screen 9-17. VuStats Display Formats — List Form

**Tables of Required and Allowed Fields**

Table 9-1. Required and Allowed Fields — Agent and Agent-Extension Data Types

| VuStats Data Type     | Format   | Period   | Threshold | Reference |
|-----------------------|----------|----------|-----------|-----------|
| acd-calls             |          | required | allowed   | required  |
| agent-extension       |          |          |           |           |
| agent-name            |          |          |           |           |
| agent-state           |          |          |           | required  |
| average-acd-call-time | required | required | allowed   |           |
| average-acd-talk-time | required | required | allowed   | required  |

*Continued on next page*

Table 9-1. Required and Allowed Fields — Agent and Agent-Extension Data Types — *Continued*

| VuStats Data Type              | Format   | Period   | Threshold | Reference |
|--------------------------------|----------|----------|-----------|-----------|
| average-extension-time         | required | required | allowed   |           |
| call-rate                      |          | required | allowed   |           |
| current-reason-code            |          |          | allowed   |           |
| current-reason-code-name       |          |          | allowed   |           |
| elapsed-time-in-state          |          |          |           |           |
| extension-calls                |          | required | allowed   |           |
| extension-incoming-calls       |          |          | allowed   |           |
| extension-outgoing-calls       |          |          | allowed   |           |
| shift-acd-calls                |          |          | allowed   | required  |
| shift-aux-time-1               | required |          | allowed   |           |
| shift-aux-time-2               | required |          | allowed   |           |
| shift-aux-time-3               | required |          | allowed   |           |
| shift-aux-time-4               | required |          | allowed   |           |
| shift-aux-time-5               | required |          | allowed   |           |
| shift-aux-time-6               | required |          | allowed   |           |
| shift-aux-time-7               | required |          | allowed   |           |
| shift-aux-time-8               | required |          | allowed   |           |
| shift-aux-time-9               | required |          | allowed   |           |
| shift-aux-time-all             | required |          | allowed   |           |
| shift-aux-time-default         | required |          | allowed   |           |
| shift-aux-time-non-default     | required |          | allowed   |           |
| shift-aux-time-reason-code     | required |          | allowed   |           |
| shift-average-acd-talk-time    | required |          | allowed   | required  |
| skill-level                    |          |          |           | required  |
| split-acceptable-service-level | required |          |           | required  |
| split-acd-calls                |          | required | allowed   | required  |
| split-after-call-sessions      |          |          | allowed   | required  |
| split-agents-available         |          |          | allowed   | required  |

*Continued on next page*

**Table 9-1. Required and Allowed Fields — Agent and Agent-Extension Data Types — *Continued***

| VuStats Data Type               | Format   | Period   | Threshold | Reference |
|---------------------------------|----------|----------|-----------|-----------|
| split-agents-in-after-call      |          |          | allowed   | required  |
| split-agents-in-aux-1           |          |          | allowed   | required  |
| split-agents-in-aux-2           |          |          | allowed   | required  |
| split-agents-in-aux-3           |          |          | allowed   | required  |
| split-agents-in-aux-4           |          |          | allowed   | required  |
| split-agents-in-aux-5           |          |          | allowed   | required  |
| split-agents-in-aux-6           |          |          | allowed   | required  |
| split-agents-in-aux-7           |          |          | allowed   | required  |
| split-agents-in-aux-8           |          |          | allowed   | required  |
| split-agents-in-aux-9           |          |          | allowed   | required  |
| split-agents-in-aux-all         |          |          | allowed   | required  |
| split-agents-in-aux-default     |          |          | allowed   | required  |
| split-agents-in-aux-non-default |          |          | allowed   | required  |
| split-agents-in-other           |          |          | allowed   | required  |
| split-agents-on-acd-calls       |          |          | allowed   | required  |
| split-agents-on-extension-calls |          |          | allowed   | required  |
| split-agents-staffed            |          |          | allowed   | required  |
| split-average-acd-talk-time     | required | required | allowed   | required  |
| split-average-after-call-time   | required |          | allowed   | required  |
| split-average-speed-of-answer   | required | required | allowed   | required  |
| split-average-time-to-abandon   | required | required | allowed   | required  |
| split-call-rate                 |          |          | allowed   | required  |
| split-calls-abandoned           |          | required | allowed   | required  |
| split-calls-flowed-in           |          | required | allowed   | required  |
| split-calls-flowed-out          |          | required | allowed   | required  |
| split-calls-waiting             |          |          | allowed   | required  |
| split-extension                 |          |          |           | required  |
| split-name                      |          |          |           | required  |

*Continued on next page*

**Table 9-1. Required and Allowed Fields — Agent and Agent-Extension Data Types — *Continued***

| VuStats Data Type              | Format   | Period   | Threshold | Reference |
|--------------------------------|----------|----------|-----------|-----------|
| split-number                   |          |          |           | required  |
| split-objective                |          |          |           | required  |
| split-oldest-calling-waiting   | required |          | allowed   | required  |
| split-percent-in-service-level |          | required | allowed   | required  |
| split-total-acd-talk-time      | required | required | allowed   | required  |
| split-total-after-call-time    | required | required | allowed   | required  |
| split-total-aux-time           | required | required | allowed   | required  |
| time-agent-entered-state       |          |          |           | required  |
| total-acd-call-time            | required | required | allowed   |           |
| total-acd-talk-time            | required | required | allowed   |           |
| total-after-call-time          | required | required | allowed   |           |
| total-aux-time                 | required | required | allowed   |           |
| total-available-time           | required | required | allowed   |           |
| total-hold-time                | required | required | allowed   |           |
| total-staffed-time             | required | required | allowed   |           |

**Table 9-2. Required and Allowed Fields —  
 Split Data Types**

| VuStats Data Type         | Format   | Period   | Threshold |
|---------------------------|----------|----------|-----------|
| acceptable-service-level  | required |          |           |
| acd-calls                 |          | required | allowed   |
| after-call sessions       |          |          | allowed   |
| agents-available          |          |          | allowed   |
| agents-in-after-call      |          |          | allowed   |
| agents-in-aux-1           |          |          | allowed   |
| agents-in-aux-2           |          |          | allowed   |
| agents-in-aux-3           |          |          | allowed   |
| agents-in-aux-4           |          |          | allowed   |
| agents-in-aux-5           |          |          | allowed   |
| agents-in-aux-6           |          |          | allowed   |
| agents-in-aux-7           |          |          | allowed   |
| agents-in-aux-8           |          |          | allowed   |
| agents-in-aux-9           |          |          | allowed   |
| agents-in-aux-all         |          |          | allowed   |
| agents-in-aux-default     |          |          | allowed   |
| agents-in-aux-non-default |          |          | allowed   |
| agents-in-other           |          |          | allowed   |
| agents-on-acd-calls       |          |          | allowed   |
| agents-on-extension-calls |          |          | allowed   |
| agents-staffed            |          |          | allowed   |
| average-acd-talk-time     | required | required | allowed   |
| average-after-call-time   | required |          | allowed   |
| average-speed-of-answer   | required | required | allowed   |
| average-time-to-abandon   | required | required | allowed   |
| call-rate                 |          |          | allowed   |
| calls-abandoned           |          | required | allowed   |

*Continued on next page*

**Table 9-2. Required and Allowed Fields —  
 Split Data Types — *Continued***

| VuStats Data Type        | Format   | Period   | Threshold |
|--------------------------|----------|----------|-----------|
| calls-flowed-in          |          | required | allowed   |
| calls-flowed-out         |          | required | allowed   |
| calls-waiting            |          |          | allowed   |
| oldest-calling-waiting   | required |          | allowed   |
| percent-in-service-level |          | required | allowed   |
| split-extension          |          |          |           |
| split-name               |          |          |           |
| split-number             |          |          |           |
| split-objective          |          |          |           |
| total-acd-talk-time      | required | required | allowed   |
| total-after-call-time    | required | required | allowed   |
| total-aux-time           | required | required | allowed   |

**Table 9-3. Required and Allowed Fields — VDN Data Types**

| VuStats Data Type         | Format   | Period   | Threshold |
|---------------------------|----------|----------|-----------|
| acceptable-service-level  | required |          |           |
| acd-calls                 |          | required | allowed   |
| average-acd-talk-time     | required | required | allowed   |
| average-speed-of-answer   | required | required | allowed   |
| average-time-to-abandon   | required | required | allowed   |
| calls-abandoned           |          | required | allowed   |
| calls-flowed-out          |          | required | allowed   |
| calls-forced-busy-or-disc |          | required | allowed   |
| calls-offered             |          | required | allowed   |
| calls-waiting             |          |          | allowed   |
| non-acd-connected-calls   |          | required | allowed   |
| oldest-calling-waiting    | required |          | allowed   |
| percent-in-service-level  |          | required | allowed   |
| total-acd-talk-time       | required | required | allowed   |
| vdn-extension             |          |          |           |
| vdn-name                  |          |          |           |

**Table 9-4. Required and Allowed Fields — Trunk Group Data Types**

| <b>VuStats Data Type</b>   | <b>Format</b> | <b>Period</b> | <b>Threshold</b> |
|----------------------------|---------------|---------------|------------------|
| average-incoming-call-time | required      | required      | allowed          |
| average-outgoing-call-time | required      | required      | allowed          |
| incoming-abandoned-calls   |               | required      | allowed          |
| incoming-calls             |               | required      | allowed          |
| incoming-usage             | required      | required      | allowed          |
| number-of-trunks           |               |               |                  |
| outgoing-calls             |               | required      | allowed          |
| outgoing-completed-calls   |               | required      | allowed          |
| outgoing-usage             | required      | required      | allowed          |
| percent-all-trunks-busy    |               | required      | allowed          |
| percent-trunks-maint-busy  |               | required      | allowed          |
| trunk-group-name           |               |               |                  |
| trunk-group-number         |               |               |                  |
| trunks-in-use              |               |               | allowed          |
| trunks-maint-busy          |               | required      | allowed          |



## Hospitality

# 10

---

This section contains the following DEFINITY ECS Hospitality features. Hospitality forms are located at the end of this chapter. Note that in this section, the term “guest” refers to a guest or a patient.

| <b>Feature</b>                       | <b>Page</b>           |
|--------------------------------------|-----------------------|
| Attendant Room Status                | <a href="#">10-2</a>  |
| Automatic Wakeup                     | <a href="#">10-4</a>  |
| Do Not Disturb                       | <a href="#">10-11</a> |
| Hospitality Services                 | <a href="#">10-15</a> |
| Names Registration                   | <a href="#">10-17</a> |
| Property Management System Interface | <a href="#">10-21</a> |

| <b>Form</b>       | <b>Page</b>           |
|-------------------|-----------------------|
| Hospitality Forms | <a href="#">10-29</a> |

## Attendant Room Status

---

Attendant Room Status allows the attendant to see whether a room is vacant or occupied and each room's housekeeping status.

### NOTE:

This feature is available only if you have Enhanced Hospitality enabled on the System-Parameters Customer-Options form. (See your Lucent Technologies support representative for assistance with this form.)

## How to administer Attendant Room Status

---

### Required forms

---

| Form                      | Field                       | Page                  |
|---------------------------|-----------------------------|-----------------------|
| Attendant Console         | ■ Feature Button Assignment | <a href="#">5-35</a>  |
|                           | — occ-rooms                 |                       |
|                           | — maid-stat                 |                       |
| Hospitality               | ■ All of page 3             | <a href="#">10-30</a> |
| Language Translations     | Page 4                      | <a href="#">5-193</a> |
|                           | ■ fields 15 through 17      |                       |
| Feature Access Code (FAC) | Page 5                      | <a href="#">5-113</a> |

## Detailed description

---

### Check In/Check Out Status

The attendant determines check in/check out status by pressing the OCC-ROOMS (occupied rooms) button on the attendant console.

This activates check in/checkout mode. The DXS lamps light for all occupied rooms. The console displays a message indicating that it is in check in/check out mode.

Occupancy status normally updates as guests check in and out.

### Maid Status

The attendant determines maid status by pressing the MAID-STAT button on the attendant console. This activates Maid-Status mode. The attendant is prompted to enter a status number (1 through 6). The display shows the state corresponding to that number and lights the DXS lamps for all rooms currently in that state.

While the console is in Maid-Status mode, the attendant can enter another status number. The console display shows the new status and lights the DXS lamps for all rooms in that state.

The status of a room updates when a maid or inspector dials from the room and changes the status.

The messages that appear on the console identify each of six states and are user-defined. (For example, you could define state 1 as clean, ready to use and state 2 as occupied, needs cleaning). As with other display messages, administer the prompts and status messages for a specific language.

## Considerations

---

- The feature is not available for attendants connected to the switch by a distributed communications system (DCS). Attendant consoles are the only terminals that can access this feature

## Interactions

---

- **Outgoing Calls**

When Check in/Check out mode is active, the attendant can make outgoing calls via the keypad. The attendant can return to normal mode or any other mode by pressing the appropriate button on the console. Check in/Check out mode does not affect other attendant operations.

When Maid Status mode is active, the attendant cannot make outgoing calls via the keypad. However, the attendant can make calls via the DXS module or the feature buttons. Attendant can return to normal mode or any other mode by pressing the appropriate button on the console.

## Automatic Wakeup

---

Automatic Wakeup allows attendants, front desk users, and guests to place an automatic wakeup call to a certain extension at a later time.

If the Dual Wakeup enhancement is activated, each extension is allowed two wakeup call requests within one 24-hour time period. If the Room Activated Wakeup with Tones enhancement is activated, wakeup calls can be activated via tones that prompt users for the time they wish to waken. These enhancements are activated on the change system-parameters hospitality form by entering **y** in the Dual Wakeup and Room Activated Wakeup with Tones fields. These options default to **y** and can only be changed by Lucent Technologies personnel.

### How to administer Automatic Wakeup

---

#### Required forms

| Form                            | Field  | Page                 |
|---------------------------------|--|----------------------|
| Station<br>(multi-appearance)   | ■ Feature Button Assignment  | <a href="#">6-28</a> |
|                                 | — auto-wkup  |                      |
|                                 | — aut-msg-wt for the extension that is the “Extension to Receive Failed Wakeup LWC Messages” |                      |
|                                 | ■ Display Language   |                      |
| Attendant Console               | ■ Feature Button Assignments   | <a href="#">5-35</a> |
|                                 | — auto-wkup  |                      |
|                                 | — aut-msg-wt for the extension that is the “Extension to Receive Failed Wakeup LWC Messages” |                      |
|                                 | ■ Display Language   |                      |
|                                 | ■ Default Announcement Extension (if the Announcement Type is multiple-integrated)           |                      |
| Announcements/<br>Audio Sources | ■ All  | <a href="#">5-26</a> |
|                                 | — integrated   |                      |
|                                 | — integ-rep  |                      |

*Continued on next page*

**Required forms — Continued**

| Form                      | Field   | Page                  |
|---------------------------|---|-----------------------|
| Class of Service          | ■ Console Permission  | <a href="#">5-81</a>  |
| Feature Access Code (FAC) | ■ Announcement Access Code<br>■ Automatic Wakeup Call Access Code<br>■ Verify Wakeup Announcement Code  | <a href="#">5-113</a> |
| Hospitality               | ■ Announcement Type<br>■ Length of Time to Remain Connected to an Announcement<br>■ Announcement Ports<br>■ Auxiliary Board for Announcement<br>■ Extension of Journal/Schedule Printer<br>■ Extension of PMS Log Printer<br>■ Extension to Receive Failed Wakeup LWC Messages<br>■ Routing Extension on Unavailable Voice Synthesis<br>■ Time of Scheduled Wakeup Activity Report<br>■ Time of Scheduled Wakeup Summary Report | <a href="#">10-30</a> |

**Detailed description**

Wakeup requests may be placed from 5 minutes to 23 hours and 55 minutes in advance of a wakeup call.

When a user answers a wakeup call, the system can provide a recorded announcement, a speech-synthesis announcement, music, or silence depending on the administration of Automatic Wakeup.

All wakeup times entered into the system round to the nearest five minutes. For example, a requested time of 6:58 am stores in the system as 7:00 am. The switch bases time-validity checks on the rounded figure.

Wakeup calls are placed within two and one-half minutes of the requested time, and never reroute, forward, or go to coverage. Before placing the wakeup call, the system overrides Do Not Disturb for the extension.

If a wakeup-call attempt is not answered or if the extension is busy, the system tries two more times at 5-minute intervals. If the call does not complete after three attempts, the switch leaves a LWC message for a designated extension (usually assigned to a button on the attendant console or backup voice terminal). The system maintains a complete record of all wakeup-call activity for the past 24 hours.

Users with touch-tone dialing can enter a wakeup request (if they have a speech synthesizer board and no display set) or can have the attendant set a wakeup time. Users with rotary-dial terminals call the attendant to request a wakeup call.

Activate Automatic Wakeup either by dialing the FAC or by pressing the automatic wakeup entry button. If the system has a speech synthesizer board, the system provides voice prompting. If the user has a display set, the system provides display prompting.

- Voice Prompting with Room Activated with Tones Off

A guest enters his or her own wakeup-call request. The request is entered only for the extension where the call originates.

After the user dials the Automatic Wakeup FAC, the system generates voice prompts (the system must have a voice synthesizer). These prompts tell the user when to enter information and what information is needed. Use touch-tone buttons to enter the information. The system accepts military or standard time. The user dials the automatic wakeup FAC again to change or delete a wakeup request.

If the user makes invalid entries, a standard message generates that notifies the user of the error. The system then repeats the original prompt for input. If invalid entries occur on the second try, the system informs the user to dial the attendant for assistance.

- Voice Prompting with Room Activated with Tones On

A guest enters his or her own wakeup-call request. The request is entered only for the extension where the call originates.

After the user dials the Automatic Wakeup FAC, the system generates recall dial tone (the system does not need a voice synthesizer). This dial tone prompts the user to enter the time in a 24-hour, 4-digit format. Confirmation tone means that the wakeup request is successful.

- Display Prompting with Dual Wakeup Off

Display prompting is provided to attendants, front-desk users, and to other users with display-equipped voice terminals. Administer front-desk users (or any other voice terminals you want to grant permissions to) with a console permission class of service (COS) to perform the same actions as the attendant. Other users can enter a wakeup request only for the extension where the call originates.

The attendant presses the automatic wakeup entry button to activate the feature. If the attendant is on an active call with a system user, the user's extension displays as the default extension after pressing the pound sign

(#). If the displayed extension is not the extension of the user requesting the wakeup call, the attendant can change it. Display prompting continues until the attendant enters all necessary information and the request for the wakeup call is confirmed.

If a condition exists that does not allow the system to accept the wakeup request, the system displays the reason for denial. Wakeup requests are denied for one of the following reasons:

- Too Soon — Indicates that the requested wakeup time is within the current five-minute wakeup interval
- System Full — Indicates that the maximum number of wakeup calls is reached
- Interval Full — Indicates that the maximum number of wakeup calls in any 15-minute interval is reached

The attendant can change or cancel a wakeup call request at any time.

■ Display Prompting with Dual Wakeup On

Display prompting with Dual Wakeup works the same as Display Prompting with Dual Wakeup off (described in the previous text), except that after the first wakeup request is entered, the user is prompted for the second wakeup request.

When the system places a wakeup call, one of the following occurs:

- Extension Is Busy — The wakeup call is placed again later.
- No Answer — The extension rings for 30 seconds. If the call is not answered, the system tries again later.
- Ringing Blockage — If four or more ports on the same analog-circuit pack are already ringing, the system waits 16 seconds and tries again. If the second attempt is blocked, the call has failed and the system waits five minutes before trying again.
- Call Is Answered — The guest answers the wakeup call and hears either music, a recorded announcement, the speech-synthesizer announcement, or silence.
- System Reset — indicates that a system reset level 1 or system reset level 2 occurred while the system attempted to place the wakeup call. Calls affected by these conditions are treated as other wakeup attempts.

If a wakeup call is incomplete because of a busy, no answer, ringing blockage, or system reset, the system attempts to place the call two more times at five-minute intervals. If the call is not completed after three attempts, the system leaves an LWC message.

A special extension, called the Wakeup Messages Extension, is administered exclusively for receiving failed wakeup-call LWC messages. When a failed

message is retrieved, the display shows the date, time, and extension for the failed wakeup-call attempt.

Assign an automatic-message waiting (AMW) button and associated lamp to attendant consoles or front-desk terminals. The number associated with the button can be the wakeup-messages extension. The AMW lamp lights when a failed wakeup message is waiting. The user retrieves the message by invoking coverage-message retrieval on the wakeup-message extension. The user presses the AMW button to place the console or terminal in coverage-retrieval mode. The user then retrieves the failed wakeup-call attempt messages. Only attendants and specified voice-terminal users can retrieve and delete failed wakeup messages.

The system maintains an audit-trail record of wakeup-call activity for the past 24 hours. The wakeup-call buffer can only hold a number of records equal to the maximum number of stations administrable on the switch. For example, if a maximum of 200 stations is administrable, only 200 automatic-wakeup records are stored.

You can display wakeup events at the management terminal, or print to a designated printer. If the system has a journal printer, wakeup events print as they occur.

The audit trail record contains the following information:

- Type of event:
  - Request — A new wakeup-call request is made.
  - Change — The time is changed on an existing wakeup-call request.
  - Cancel — A wakeup request is canceled.
  - Move To — The wakeup request for this room moves to another room.
  - Move From — The wakeup request for another room moves from the old room to the new room.
  - Move-Cancel — A wakeup request from another room replaces the request for this room.
  - Swap — A room swap occurs and at least one of the rooms has a wakeup request. Wakeup calls swap when a room swap is performed. A journal entry is made for each room. If the room receives a wakeup call as the result of the swap, the time of the call is provided in the entry. If the room loses a wakeup call as the result of the swap (and has not received another), the time is not present in the entry.
  - Completed — The wakeup call completes successfully.
  - Not Completed — The wakeup call failed.



— Skip — The wakeup call is skipped. This event occurs if the system time advances past the requested time of a wakeup call.

- Time of the event
- Extension number receiving the call
- Time of the wakeup request
- Extension (or 0 for the attendant) where the event took place
- Number of call attempts that were placed
- An indication of why a wakeup-call attempt failed

In addition, all wakeup-time changes are recorded. This record shows the original time requested and the changed time. The audit-trail record is not backed up and all wakeup data is lost if a system failure occurs.

Schedule the following reports for printing on a daily basis:

- Wakeup Activity report – summarizes wakeup activity for each extension that had any wakeup activity over the past 24 hours.
- Wakeup Summary report — gives an hour-by-hour summary of the number of scheduled wakeup calls, the number of wakeup calls completed, and a list of extensions. The report covers all automatic-wakeup events for each hour over a 24-hour period.

With VDNs and multiple announcements, you can choose as the announcement extension a VDN that reaches one announcement if the system clock is less than 12:00 and another if the system clock is greater than 12:00. The hotel guest hears “good morning” before noon and “good evening” after noon. Or, a business customer can choose as the announcement extension a VDN that points to an extension assigned to a quorum bridge, with the wakeup time as a scheduled teleconference time. When the wakeup call is completed, the customer automatically connects to the teleconference bridge.

You can administer a multiple announcement to repeat. To enable repeating announcements, enter announcement type *integ-rep* on the Recorded Announcement form. With repeating integrated-message functionality, the announcement keeps repeating from when the first guest (of a group of guests receiving the same wakeup announcement at the same time) goes off-hook until the last guest goes on-hook.

If the announcement type is either an externally-recorded announcement or is integrated-repeating, you can administer the wakeup-call queue for barge-in. Barge-in means that the guest receiving the wakeup call hears the announcement as soon as he or she is off-hook, even if the announcement is not at the beginning. This provides the capability of many users being bridged onto the same announcement port, eliminating the need for a separate port for each wakeup call. For additional information, see Recorded Announcement.

## Considerations

---

- Up to 10 attendant consoles and/or front desk terminals may be in the wakeup display mode at any one time.
- Wakeup call attempts are not rerouted, forwarded, or sent to coverage.

## Interactions

---

- Attendant or Voice Terminal Display

If the console or terminal is in automatic-wakeup mode and the user presses another display-mode button, wakeup mode aborts and the wakeup request is not entered, changed, or deleted.
- Do Not Disturb

If Do Not Disturb is active at a voice terminal, Automatic Wakeup deactivates Do Not Disturb for that terminal, and the system places the wakeup call.
- PMS Interface

A Check-Out request cancels an active-wakeup call request for the guest room. Room Change/Room Swap requests through PMS cause a wakeup request to change or swap.
- Voice Synthesis Board

Auto Wakeup competes with the following features for use of the speech-synthesizer board.

  - Do Not Disturb
  - Leave Word Calling Message Retrieval
  - Visually Impaired Attendant Service

## Do Not Disturb

---

Do Not Disturb allows guests, attendants, and authorized front-desk voice-terminal users (those with console permission) to request that no calls, other than priority calls, terminate at a particular extension until a specified time. At the specified time, the system automatically deactivates the feature and allows calls to terminate normally at the extension.

### How to administer Do Not Disturb

---

#### Required forms

---

| Form                                 | Field  | Page                  |
|--------------------------------------|--|-----------------------|
| Attendant Console                    | ■ Feature Button Assignments                             | <a href="#">5-35</a>  |
|                                      | — dn-dst   |                       |
|                                      | — grp-dndst  |                       |
| Station<br>(multiappearance)         | ■ Feature Button Assignments                             | <a href="#">6-28</a>  |
|                                      | — dn-dst   |                       |
|                                      | — ext-dn-dst   |                       |
|                                      | — grp-dn-dst   |                       |
| Feature Access Code<br>(FAC)         | ■ Group Control Restrict Activation or Deactivation      | <a href="#">5-113</a> |
| Feature-Related System<br>Parameters | ■ Controlled Termination Restriction<br>(Do Not Disturb) | <a href="#">5-123</a> |
|                                      | — tone   |                       |

### Detailed description

---

Do Not Disturb is a form of termination restriction associated with an automatic deactivate time. When Do Not Disturb is active, the user receives only those calls associated with Automatic Callback, Automatic Wakeup, and Priority Calling, and those calls that are redirected to that extension via the Call Coverage and Call Forwarding All Calls. All other calls redirect to a recorded announcement, an attendant, or intercept tone.

Voice-terminal users with touch-tone dialing can activate this feature themselves or ask the front desk to do it for them. Users with rotary-dial terminals must call the attendant or front-desk user to request Do Not Disturb.

## Activation by Voice Terminal Users

Voice-terminal users can activate Do Not Disturb by dial access or by button access. If users have a speech-synthesizer board, they can activate Do Not Disturb themselves, without attendant assistance.

- Dial Access

When a user dials a Do Not Disturb feature access code (FAC), the system prompts the user to enter a deactivate time. The user may later change or delete the request by dialing the Do Not Disturb FAC again and entering the required information.

If the user makes invalid entries or if system conditions prevent entry of the request, the system informs the user to dial the attendant or front desk for assistance, if the user has a speech-synthesizer board.

- Button Access

If a voice terminal has a Do Not Disturb button, the user can press the button to activate the feature. The handset may be on-hook or off-hook. The user presses the button a second time to deactivate the feature.

The lamp associated with the Do Not Disturb button lights until the feature is deactivated with the button. An automatic-deactivate time is not provided.

## Activation by Attendant

The attendant can activate the feature for a user or a group of users. (The assigned COR determines which users are in the group.) The attendant presses the Do Not Disturb — Extension button followed by the extension, or the Do Not Disturb — Group button. The extension followed by the appropriate COR number.

The attendant can cancel a Do Not Disturb request by activating the feature, entering the desired extension or group COR number, and pressing the delete button.

## Activation via a PMS

The system provides an interface to a Property Management System (PMS). This interface allows activation and deactivation of controlled restrictions. Activation of Do Not Disturb through a PMS is similar to activation of termination restriction. A scheduled deactivate time cannot be specified.

## Audit Trail Reports

The system keeps a record of all voice terminals that are in Do Not Disturb mode. You can display or print this information.

Administer the following reports for printing on a daily basis:

- Do Not Disturb Status Report — This report lists all extensions with Do Not Disturb active and the specified deactivate time for each.
- Do Not Disturb Plus COR Status Report — This report lists all extensions, plus those whose controlled-restriction level is termination restriction. (The attendant activates termination restriction for a specific extension or COR. A deactivate time is not associated with termination restriction.)

Records do not include Do Not Disturb information for extensions that are both termination and outward restricted.

## Considerations

---

- Do Not Disturb lessens the attendant's workload when voice-terminal users with speech-synthesizer boards activate the feature themselves.
- A front-desk user must have a console-permission COS to activate this feature.
- The number of available speech-synthesis ports is the only limit on the number of users receiving voice prompting.

## Interactions

---

- Automatic Callback  
Do Not Disturb does not block an Automatic Callback call. Return calls terminate at a voice terminal in the normal way.
- Automatic Wakeup  
An Automatic Wakeup call deactivates Do Not Disturb and alerts the guest at the specified time.
- Call Coverage  
If a point in a coverage path has Do Not Disturb active, calls covering to that extension alert the extension unless the extension has controlled-restriction termination active. When Do Not Disturb is active and a terminal does not have a coverage path, calls are routed to the attendant.
- Call Forwarding All Calls  
If Do Not Disturb is active at the forwarding extension, the caller receives intercept treatment. If Do Not Disturb is active at the forwarded-to extension, the call alerts the forwarded-to extension.

- Controlled Restriction

When a terminal has total-controlled restriction, it cannot receive or place any calls. However, it can receive a call if another station has an auto-icom button pointing to the controlled-restriction station.

- Internal Automatic Answer (IAA)

Activation of Do Not Disturb at the called voice terminal preempts IAA.

- PC Console

You cannot implement Do Not Disturb at a PC Console.

- PMS Interface

Checkout from either a PMS or the switch automatically deactivates Do Not Disturb for the specified extension.

## Hospitality Services

---

A system with Hospitality enabled and Hospitality Parameter Reduction disabled provides all system capabilities and supports all types of customers. A system with both Hospitality and Hospitality Parameter Reduction enabled provides reduced system parameters that have a major impact on essential system features used by non-lodging customers. The Hospitality features set (Auto Wakeup, Do Not Disturb, PMS) is the same on both packages.

### How to administer Hospitality Services

---

#### Required forms

---

| Form              | Field                            | Page                  |
|-------------------|----------------------------------|-----------------------|
| Hospitality       | ■ All                            | <a href="#">10-30</a> |
| COS               | ■ Client room                    | <a href="#">5-81</a>  |
| Attendant Console | ■ Hospitality Button Assignments | <a href="#">5-35</a>  |
|                   | — auto-wkup                      |                       |
|                   | — check-in                       |                       |
|                   | — check-out                      |                       |
|                   | — dn-dst                         |                       |
|                   | — ext-dn-dst                     |                       |
|                   | — mwn-act                        |                       |
|                   | — mwn-deact                      |                       |
|                   | — crss-alert                     |                       |

---

### Detailed description

---

Parameters reduced when Hospitality Parameter Reduction is enabled are listed in *DEFINITY Enterprise Communication System Release 6 System Description Pocket Reference*.

The following parameters are affected:

- Trunks
- Hunt groups
- Pickup groups
- Call coverage paths

## **Interactions**

---

None



## Names Registration

---

Names Registration automatically sends a guest's name and room extension from the PMS to the switch at checkin, and automatically removes this information at checkout.

### How to administer Names Registration

---

Refer to "[Property Management System Interface](#)" on [page 10-21](#) for information on the PMS interface and associated administration guidelines.

#### Required forms

---

| Form        | Field  | Page                  |
|-------------|--|-----------------------|
| Hospitality | ■ PMS Protocol Mode<br>— transparent or ASCII            | <a href="#">10-30</a> |
|             | ■ Default Coverage Path for Client Rooms<br>— default    |                       |
|             | ■ Milliseconds Before PMS Link Acknowledgment<br>Timeout |                       |

---

### Detailed description

---

The information provided by Names Registration displays on any attendant console or display-equipped voice terminal (as might be used for example, by Room Service, Security, and others). The information allows hotel personnel to provide personalized greetings to calling guests. For example, if John Smith calls room service, personnel with a display-equipped voice terminal, see John's name and room extension and can answer with a personalized greeting.

The name of the calling or called party can display on display-equipped voice terminals. To maintain necessary guest security, hotels do not divulge guests' room numbers to other guests or callers. For this reason, do not assign display-equipped voice terminals to guest rooms.

### Check In

The switch performs the following procedures at check in:

1. Information about the guest is obtained and stored in the hotel's PMS.
2. The PMS sends a checkin message to the switch.
3. The switch stores the guest's name and coverage path.

4. The switch removes the outward restriction on the telephone in the guest room. The switch removes all LWC messages.
5. The switch changes the status of the room from unoccupied to occupied.

At checkin, update the PBX names internal table and the call-coverage path for the guest phone. Name Registration automatically sends a guest's name, extension (room), and preferred call-coverage path to the switch.

## Check Out

1. The switch clears any previous wakeup calls.
2. The switch clears message-waiting lamp indications.
3. The switch activates controlled outward restriction, removes the guest's name, and identifies any unopened messages.

At checkout, Name Registration automatically changes the call-coverage path to the administered Default Coverage Path for Client Rooms.

## Guest Information Input/Change

Use Guest Information Input/Change to change the guest name associated with an extension, input a guest name after checkin, or change a call-coverage path. For example, hotel may checkin airline personnel before their arrival to guarantee their reservation. However, hotel personnel may be unaware of the guests' names and so wait until their arrival to update the names.

## Name Registration Information Format

For both Name Registration and Guest Information Input/Change, a guest name may consist of as many as 15 characters, including spaces and commas. Do not use periods. See ["Interactions" on page 10-19](#) for more information.

The name may be in all upper case letters, all lower case letters, or a mixture of upper case and lower case letters. To use Integrated Directory, enter the name using one of the following methods.

- Last name, comma, first name (for example, Jones, Fred)
- Last name, comma, first name, space, title/middle initial/name (for example, Jones, Fred Mr)
- Last name only (for example, Jones)
- First name, space, middle name, space, last name (for example, Fred A Jones)

## Call Coverage

Both Names Registration and Guest Information Input/Change messages contain call-coverage path numbers. These numbers do not display but are used to configure the appropriate call-coverage arrangements for guest extensions. Arrangements can be for voice mail, text messages, any available coverage point, or no coverage at all.

Administer call-coverage paths on the switch, and use the associated path numbers to establish coverage arrangements at checkin. For suites, administer paths to allow one room in the suite to be the coverage point for the other. To make customized arrangements at time of checkin (such as coverage from one guest room to another), manually administer the path attributes at the switch.

## Considerations

---

- Call-coverage path numbers sent by PMS to the switch for automatic reconfiguration are limited to those administered in the switch and stored in PMS.
- A guest room extension can have a maximum of five digits.
- An input in PMS of the name displayed on display-equipped voice terminals updates the switch.

## Interactions

---

- Call Coverage

Call-coverage arrangements are not limited to automatic update during checkin messages sent from PMS. Hotel personnel require coverage points other than those designated for guests. Call-coverage paths can be manually administered at the switch via the management terminal.
- COS

If an extension has a client room COS, the save translation operation clears the station name and sets the coverage path to the default coverage path for client room when stored on tape. This does not affect the existing information in memory. However, if the translations are read in, it affects existing extensions until a database swap synchronizes the switch and PMS.
- Interface

During a Room Change/Room Swap, the name originally associated with the first terminal is changed or swapped to the second terminal along with call-coverage path, automatic wake-up entries, message-waiting status, and controlled restrictions.

- **Name Character Length**

The switch supports 27-character names, but the PMS interface supports only 15-character names.

## Property Management System Interface

---

Property Management System (PMS) Interface provides a communications link between the switch and a customer-owned PMS. The PMS allows a customer to control certain features in a hospital and hotel/motel environments. Refer to *DEFINITY ECS GuestWorks Server and System 75 Property Management Interface Specifications*.

### How to administer PMS Interface

---

#### Required forms

---

| Form  | Field   | Page                  |
|---|---|-----------------------|
| Class of Service                                    | ■ Client Room (y)   | <a href="#">5-81</a>  |
|   | ■ Console Permission (y for attendant and front desk)               |                       |
| Hospitality   | ■ All   | <a href="#">10-30</a> |
| Attendant Console                                   | Feature Button Assignments  | <a href="#">5-35</a>  |
|   | ■ All Hospitality-related   |                       |
| Feature Access Code (FAC)                           | ■ All Hospitality Features  | <a href="#">5-113</a> |
| Station (multi-appearance)<br>(front desk terminal) | Button/Feature Button Assignments                                   | <a href="#">6-28</a>  |
|   | ■ All Hospitality-related   |                       |
| Data Modules  |   |                       |
| Netcon (R5si and later configurations only)         | ■ All   | <a href="#">6-245</a> |
|   | ■ All (one for PMS link and one for each printer, log, and journal) | <a href="#">6-243</a> |
| MPDM  | ■ All   | <a href="#">6-234</a> |
| Data Line<br>7400 A, 7400 B                         | ■ All   | <a href="#">6-90</a>  |

## Detailed description

The following table summarizes how the hospitality features are activated when you use only the switch and when you use the PMS.

### **PMS/Switch links**

| <b>Feature</b>                                      | <b>Switch Only</b>   | <b>With PMS</b>   |
|---|--|---|
| Automatic Wakeup                                    | Activated via console button                                   | N/A   |
| Call Coverage                                       | Activated via administration with TERRANOVA ECS Administration | Activated via PMS terminal — Transparent or ASCII mode          |
| Check-In/Check-out                                  | Activated via console button                                   | Activated via PMS terminal — Normal, Transparent, or ASCII mode |
| Controlled Restriction                              | Activated via console button                                   | Activated via PMS terminal — Normal, Transparent, or ASCII mode |
| Do Not Disturb                                      | Activated via console button                                   | Activated via PMS terminal — Normal, Transparent, or ASCII mode |
| Emergency Access to Attendant                       | Activated by guest action                                      | N/A   |
| Housekeeping Status                                 | Activated via console button                                   | Activated via PMS terminal — Normal, Transparent, or ASCII mode |
| Message Waiting Notification                        | Activated via console button                                   | Activated via PMS terminal — Normal, Transparent, or ASCII mode |
| Names Registration                                  | Activated via administration with TERRANOVA ECS Administration | Activated via PMS terminal — Transparent or ASCII mode          |
| Room Change/Swap and Guest Information Input/Change | Activated via administration with TERRANOVA ECS Administration | Activated via PMS terminal — Normal, Transparent, or ASCII mode |
| Room Occupancy                                      | Activated via console button                                   | Activated via PMS terminal — Normal, Transparent, or ASCII mode |

The PMS Interface provides the following:

- A communications protocol for controlling message exchange between the switch and a PMS
- An application module for controlling the operation of PMS features
- Status data on all guest/patient rooms for selected features

The protocol is full-duplex asynchronous and provides the mechanisms for setting up a data session with PMS, message-exchange control, error identification, and recovery. The interface supports standard data rates.

Two protocol modes are provided: the normal-protocol mode as described above, and transparent-protocol mode. Transparent-protocol mode supports ASCII-character transmission.

The application module of the PMS Interface implements requested features and provides backup if the PMS link is down. Whether or not the link is down, the switch always maintains the following data for each room:

- Whether the room is vacant or occupied
- Whether the voice terminal's message lamp is on or off
- Whether a controlled restriction is active at the voice terminal and, if so, which one
- The guest's name and coverage path

When the PMS link is down, the switch automatically activates Check-In/Check-Out for the attendant console and front-desk terminal with display capability, and continues to support PMS features activated from guest/patient-room voice terminals.

When the PMS link is up again, the switch sends one of the following messages to PMS:

- No room-status changes occurred during loss of communications.
- Room-status changes did occur during loss of communications; therefore, a data exchange is needed to synchronize the switch and the PMS databases.
- The system failed momentarily, destroying its record of room status; therefore, a data exchange is needed to synchronize the switch and the PMS databases.

When the PMS link is down or not used, the switch maintains an audit-trail report of all events that are normally sent to the PMS. The audit-trail report (accessed via the management terminal) is a sequential listing of all PMS transactions executed by the switch when the PMS link is down. Included are error events that occur when the link is up or down.

If you have a PMS printer and the PMS link is down, the following status changes print as changes occur:

- Room number
- FAC dialed
- Any additional information digits that were dialed
- Reason for the entry (error message)
- Time that the error occurred

Additional reports print to the PMS Journal/Schedule printer. These include Automatic Wakeup activity, Emergency Access to the Attendant activity, and scheduled reports.

A supporting function called Room Data Image synchronizes the switch and PMS databases after a PMS link goes down and comes back up. Information exchanged includes:

- Room extension
- Whether the room is occupied or vacant
- Message Waiting lamp status
- Controlled Restriction status
- Guest's name
- Call Coverage path

### Message Waiting Notification

Message Waiting Notification requests originate from attendant consoles, front-desk terminals, or PMS terminals. When a request is entered, PMS sends a message to the switch to change the state of the Message Waiting lamp. If the lamp is activated by AUDIX, INTUITY Lodging, or Leave Word Calling (LWC), the PMS cannot deactivate the lamp. PMS cannot turn LWC or AUDIX messages on or off; these are controlled by the switch.

Assign a console permissions COS to any console or terminal as part of the "System Wide Retrieval Stations" to retrieve requests for another station. Assign a client room COS to the extensions for which Message Notification is to be made.

### Controlled Restriction

When Controlled Restriction is activated through the PMS, the PMS sends a message to the switch to assign one of the following restrictions to the voice terminal in a guest/patient room:

- No restriction
- Outward restriction
- Total restriction



- Station-to-station restriction
- Termination restriction
- Combined outward and termination restriction
- Combined outward and station-to-station restriction
- Combined termination and station-to-station restriction

The attendant can still set Controlled Restriction for a voice terminal whether the PMS link is up or down.

## PMS-Down Log

The pms-down log records only those User Controller Restriction events that are for stations having a Class of Service (COS) where:

- the Client Room is **y**
- the Controlled Restriction Configuration is **act-pms**
- the pms link is not up
- the pms log extension is valid

## Housekeeping Status

Your housekeeping staff enters status information from voice terminals in guest/patient rooms or from designated terminals. You can assign up to 10 Housekeeping Status access codes within two different types:

- Room Voice-Terminal access code type  
Staff members dial up to six access codes that represent room status plus up to six additional digits for items such as maid identification.
- Designated Voice-Terminal access code type  
Staff members dial up to four access codes that represent room status plus the room extension and then up to six additional digits for items such as maid identification.

The switch notifies PMS when Housekeeping Status information is entered. If the PMS is unavailable, the switch writes this information to a log. The log is accessible at the switch terminal, and is sent to the log printer, if administered.

## Check In/Check Out

A Check-In request deactivates the outward-controlled restriction on the terminal in a guest/patient room. A Check-Out request deactivates any controlled restrictions and changes the controlled-restriction level to outward restriction, checks for any messages, clears the wakeup request, and deactivates Do Not Disturb.

## 10 Hospitality

### Property Management System Interface

Page 10-26

If you do not use PMS or if the PMS link is down, the attendant can activate Check-In and Check-Out from an attendant console or a front-desk terminal with display capability and console permission. This requires two buttons, Check-In and Check-Out. Pressing either button places the display in the respective mode and allows use of the touch-tone or DTMF buttons for entering data (rather than for placing calls).

The attendant exits Check-In or Check-Out mode by pressing any other button associated with the display (for example, the Normal Mode button). This restores the display and the touch-tone or DTMF buttons to normal operation.

A Check-In/Check-Out request sends information for Names Registration to the switch. This information includes the guest's name, room extension, and call-coverage path. If the PMS link is down and checkin is done from an attendant console or display-equipped front-desk terminal, the guest's name and coverage-path information is not automatically updated.

If a guest/patient room has both a voice and a data extension, the checkout request applies only to the voice extension. See [“Names Registration” on page 10-17](#) for more information on Check-In and Check-Out.

### Room Change/Room Swap

Room Change/Room Swap is provided only through PMS and activated from a PMS terminal. With Room Change, data pertaining to the old room — including a pending wakeup request, the guest's name (transparent/ASCII mode), and the guest's call-coverage path (transparent/ASCII mode) — moves to the new room. With Room Swap, data pertaining to the two rooms swap. With either feature, if the occupancy status is inconsistent, the system sends an error message to PMS.

### Names Registration

Names Registration automatically sends a guest's name and room extension from PMS to the switch at checkin, and removes this information at checkout. The guest's call-coverage path is sent to the switch during checkin and set to the administered Default Call Coverage Path for Client Rooms at checkout.

### Guest Information Input/Change

Guest Information Input/Change allows the attendant to enter or alter guest information (name or coverage path). Information changed at the PMS is automatically sent to the switch.

## PMS/INTUITY Message Tandeming

PMS/INTUITY Message Tandeming allows the following PMS administrative messages to tandem through the switch to an INTUITY Lodging adjunct. This eliminates the need for the INTUITY-to-PMS voice messaging link. This does not remove the need for the INTUITY-to-PMS call accounting link.

- Check-in
- Check-out
- Room-data-image
- Guest-information
- Message-waiting status
- Room-swap

When the Data Communication Interface Unit (DCIU) (DEFINITY/INTUITY interface) link is down and the PMS/DEFINITY link is up, The switch buffer holds up to 100 PMS messages. The switch updates the INTUITY Lodging adjunct once the DCIU link is up. If the buffer overflows before the link is up, the database resync among PMS/DEFINITY/INTUITY initiates by demand or by a routine database update from PMS.

Note that in GuestWorks, this feature is called "Server/INTUITY/PMS Link Integration".

## Considerations

- You can use LWC or Integrated Message Center Service for the hospital or hotel/motel staff and Message Waiting Notification for guests/patients. However, if you do not use Message Waiting Notification, Integrated Message Center Service is used for both.
- Do not remove an extension while the PMS link is active.
- Normal-protocol mode allows extensions of up to four digits. Transparent/ASCII-protocol mode allows extensions of up to five digits.
- When save translations is done when transparent/ASCII-protocol mode is active, station names with client-room COS save as blank and coverage paths save as the default coverage path for client rooms.
- The PMS link may not work correctly when multiple p-extensions have the same leading digit and adjacent lengths. For example, 3 and 4 p-extensions with the same leading digit may cause problems. The same applies to 4 and 5, and 5 and 6.
- A room extension may begin with 0 only if the PMS sends a prefix digit or a fixed number of digits.

## Interactions

---

- Attendant Console or Front Desk Terminal  
Activate Controlled Restriction, Check-In/Check-Out, and Message Waiting Notification at an attendant console or a front-desk terminal with console permission. The attendant console receives visual notification of the status of the PMS link between the system and the PMS.
- AUDIX Interface  
Message lamps activated by this feature cannot deactivate with feature buttons or with feature messages from the PMS.
- Automatic Wakeup  
Set or cancel an Automatic Wakeup request for a guest room as a result of Room Change/Room Swap or Check-Out.
- Do Not Disturb  
Set or cancel a Do Not Disturb request for a guest room as a result of a different Controlled Restriction, Room Change/Room Swap, or Check-Out.
- Leave Word Calling (LWC)  
Message lamps activated by this feature cannot deactivate with Manual Message Waiting feature buttons.  
If Room Change is active, LWC messages for the old room do not move to the new room. If Room Swap is active, LWC messages for the two rooms do not swap. Therefore, do not encourage use of LWC in guest rooms.
- Restriction — Controlled  
Controlled Restriction for a group of user extensions, when activated from the switch, is not conveyed to the PMS. The PMS is not able to add or remove such restrictions by sending feature messages.

# Hospitality Forms

## Hospitality

---

This form is used to implement the system parameters associated with the hospitality features. To use and administer the Hospitality-related features, Hospitality must be enabled on the System-Parameters Customer-Options form. Contact your Lucent Technologies support representative for assistance.

### Administration Commands

---

Use the following administration commands to administer the Hospitality form.

| Action  | Object                        | Qualifier <sup>1</sup>  |
|---------|-------------------------------|-------------------------|
| change  | system-parameters hospitality | —                       |
| display | system-parameters hospitality | ['print' or 'schedule'] |

1. Brackets [ ] indicate the qualifier is optional. Single quotes ( ' ') indicate the text inside the quote must be entered exactly as shown or an abbreviated form of the word can be entered.

### Form Instructions

---

Make assignments as required for the following fields on each page of the form:

#### Page 1 of the Form

- **Message Waiting Configuration** — This indicates whether message waiting notification requests and changes are being exchanged between the server and the PMS. Allowable entries are **act-nopms**<sup>1</sup> or **act-pms**. The option **act-nopms** indicates that message waiting is operational on the server but message waiting information is not being transmitted between the PMS and server. The option **act-pms** indicates that message waiting is active on the server and information between the PMS and server is being transmitted. The default is **act-nopms**.
- **Controlled Restrictions Configuration** — This indicates whether controlled restriction information is being exchanged between the server and the PMS. If active (**act-pms**), the server and the PMS exchange and accept controlled restriction information. Allowable entries are **act-nopms**<sup>1</sup> and **act-pms**. The default is **act-nopms**.

---

1. If **act-nopms**, the message is acknowledged (MESSAGE ACK), but no action is taken.

- **Housekeeper Information Configuration** — This indicates whether housekeeper information is being exchanged between the server and the PMS. If active (**act-pms**), the server and PMS exchange and accept housekeeper information. Allowable entries are **act-nopms**<sup>1</sup> or **act-pms**. The default is **act-nopms**.
- **Number of Housekeeper ID Digits** — This is the number of digits (0 to 6) that the housekeeper must dial for identification. The default is 0.
- **Extension of PMS Log Printer** — This is a valid data extension number (cannot be a VDN extension) that is assigned to the data module connected to the PMS/Log printer. This extension is dialed by the server to send housekeeping and PMS events to the printer.
- **Extension of Journal/Schedule Printer** — This is a valid data extension number (cannot be a VDN extension) that is assigned to the data module connected to the Journal/Schedule printer. This extension can be the same as the PMS/Log printer and both sets of reports may be printed on the same printer. This extension is dialed by the server to send journal information or schedule reports to the printer.
- **Client Room Coverage Path Configuration** — This indicates whether the server and the PMS exchange coverage path information for guest stations. If active (**act-pms**), the server and PMS exchange and accept coverage path information. Allowable entries are **act-nopms**<sup>2</sup> or **act-pms**. This field does not apply to normal mode. When upgrading from a release that does not support this feature, the field is set to **act-pms** if the PMS protocol mode is administered for transparent or ASCII mode. The default is **act-nopms**.
- **Default Coverage Path for Client Rooms** — This indicates the coverage path assigned when the server receives a check-out message for a valid extension or a new check-in. This applies only to stations with a “client room” class of service in the “occupied” mode. This field does not apply to normal mode; it is used only for transparent or ASCII mode. The value in this field is also used during a translation save as the coverage path for each station with “client room” class of service.
- **Forward PMS Message to INTUITY Lodging** — This indicates whether the PMS-to-INTUITY messages will be sent through the server (y) or directly to the Lucent INTUITY Lodging system (n). This field does not apply to normal mode; it is used only in ASCII mode.
- **Extension of PMS** — This indicates the data extension number (cannot be a VDN extension) the server must dial to access PMS. When this extension is entered and PMS is ready, the server brings up the link.
- **PMS Protocol Mode** — This indicates the message protocol mode used between the server and PMS. Allowable entries are **normal** and **transparent**. The default is **normal**.

---

2. If **act-nopms**, the message is acknowledged (MESSAGE ACK), but no action is taken.

- **ASCII mode** — This indicates whether the ASCII-only mode is being used for the PMS message set. The PMS Protocol Mode field must be set to **transparent**. This field does not apply to normal mode. The default is **n**.
- **Seconds Before PMS Link Idle Timeout** — This indicates the idle time in seconds (**5 to 20**) that the server waits for an acknowledgment from the PMS before the server enters link failure mode from the PMS transmission link. The default is **10**.
- **Milliseconds Before PMS Link Acknowledgment Timeout** — Enter the time in milliseconds (100 to 1500) the system waits for an acknowledgment from the PMS indicating it correctly received a message. Default is **150**. The possible values are:
  - 100 - 300 ms (normal mode)
  - 100 - 1500 ms (transparent or ASCII mode)
- **PMS Link Maximum Retransmissions** — This indicates the number of times (**1 to 5**) that the server will retransmit a message to the PMS in response to a negative acknowledgment or send an inquiry for acknowledgment from the PMS before giving up on the message. The default is **3**.
- **PMS Link Maximum Retransmission Requests** — This indicates the number of times (**1 to 5**) that the server will allow the PMS to request acknowledgment for a message that it sent. The default is **3**.
- **Take Down Link for Lost Messages** — This indicates whether the link will be taken down if messages are being lost. Enter **y** to cause the PMS link to come down; enter **n** to keep the link operating. Careful monitoring of the PMS error log is recommended when using this option. The default is **y**.

## Page 2 of the Form

- **Dual Wakeup** — Enter **y** if each extension can request two wakeup calls within one 24-hour time period.
- **Room Activated Wakeup with Tones** — Enter **y** if wakeup calls can be activated via tones that prompt users for the time they wish to waken. (This allows room activated wakeup calls without the use of a speech synthesizer or a display telephone.)
- **Time of Scheduled Wakeup Activity Report** — This indicates the time of day that the Wakeup Activity Report will be printed on the Journal/Schedule Printer. This report summarizes the wakeup activity for each extension that had wakeup activity for the past 24 hours. Enter the time **hh:mm:am/pm** where hh=hour, mm=minute, am/pm=A.M. or P.M.
- **Time of Scheduled Wakeup Summary Report** — This indicates the time of day that the Wakeup Summary Report will be printed on the Journal/Schedule printer. This report gives an hour-by-hour summary of the number of scheduled wakeup calls and a list of extensions to which



wakeup calls were attempted but did not complete during the hour. Enter the time **hh:mm:am/pm** where hh=hour, mm=minute, am/pm=A.M. or P.M.

- **Time of Scheduled Emergency Access Summary Report** — This indicates the time of day that the Emergency Access Summary Report will be printed on the Journal/Schedule printer. The time is represented by **hh:mm:am/pm** where hh=hour, mm=minute, and am/pm=A.M. or P.M.
- **Announcement Type** — This indicates the type of automatic wakeup announcement the hotel guest will receive. Allowable entries are as follows:
  - external (applicable when using an announcement adjunct)

If **external** is used, complete the **Auxiliary Board for Announcement** field.
  - integrated (applicable when using the TN750B or TN750C announcement circuit pack)

If **integrated** is used, complete the **Integrated Announcement Extension** field. The extension you enter must be a valid integrated announcement extension (administered on the Recorded Announcements form) or a VDN. If you enter an invalid extension, the server displays an error message.
  - mult-integ (multi-integrated; applicable when using the TN750B or TN750C announcement circuit pack)

If **mult-integ** is used, complete the **Default Announcement Extension** field. The extension you enter must be a valid integrated announcement extension (administered on the Recorded Announcements form) or a VDN. If you enter an invalid extension, the server displays an error message.
  - voice-synthesis

If **voice-synthesis** is used, complete the **Announcement Ports** field.
  - music-on-hold

If **music-on-hold** is used, no other field appears.
  - silence (default)

If **silence** is used, no other field appears.

 **NOTE:**

One of the following four fields appears depending on what data is entered in the Announcement Type field.

- **Auxiliary Board for Announcement** — This field displays only when the **external** announcement type is used. This indicates the equipment location of an auxiliary trunk circuit that connects to the external announcement equipment. Enter a 4- or 5-character circuit pack number.

- **Integrated Announcement Extension** — This field displays only when the **integrated** announcement type is used. This indicates the wakeup announcement extension when using the integrated announcement circuit pack. Enter the extension (5-digits or less) of the announcement you want to use for wakeup calls.
- **Default Announcement Extension** — This field displays only when the **mult-integ** announcement type is used. This indicates the default wakeup announcement extension when using the integrated announcement circuit pack. Enter the extension (5-digits or less) of the announcement you want to use for default wakeup calls.
- **Announcement Ports** — This field displays only when the **voice-synthesis** announcement type is used. For the **voice-synthesis** announcement type, this indicates the equipment location of two ports on the voice synthesizer circuit pack (TN725B). Any two of the four ports can be assigned.
- **Length of Time to Remain Connected to Announcement** — Enter the length of time in seconds (**0** to **300**) that a hotel guest will be connected to an announcement. This applies only after the guest has heard the announcement completely one time, but continues to listen for a second time. The default is **30**.
- **Extension to Receive Failed Wakeup LWC Messages** — This indicates where unsuccessful wakeup LWC messages will be stored. This is usually administered to an unassigned extension (cannot be a VDN extension) or to the attendant (attd). In addition, a LWC lamp for that extension is usually assigned to the attendant console as an indication of failed wakeup calls. The default is blank.
- **Routing Extension on Unavailable Voice Synthesis** — This indicates where a wakeup call will go to if both wakeup announcements on the Speech Synthesizer circuit pack are not available. This is usually administered to an unassigned extension (cannot be a VDN extension) or to the attendant (attd). The default is blank.
- **Display Room Information in Call Display** — This indicates the type of guest room information displayed on voice terminal displays. If this field is set to **n**, the voice terminals will display the name and extension number. If this field is set to **y**, the voice terminals will display the name and room number. The extension number and room number are not always the same number. The default is **n**.
- **Number of Digits from PMS** — This indicates the number of digits being sent from the PMS to the server to identify room numbers. If using mixed numbering in the server, leave this field blank. When using normal mode, digits **1** through **4** are valid. When using transparent or ASCII mode, digits **1** through **5** are valid. The default is blank.



**NOTE:**

If the **Number of Digits from PMS** field is blank and the **PMS Sends Prefix** field is set to **n**, the server will not support an extension that starts with 0.

- **PMS Sends Prefix** — This indicates if the PMS sends a prefix digit to the server as part of the room numbering plan. This field can be set to **y** or **n**. The default is **n**.



**NOTE:**

If the **PMS Sends Prefix** field is set to **n** and the **Number of Digits from PMS** field is blank, the server will not support an extension that starts with 0.

- **Number of Digits in PMS Coverage Path** — This indicates whether the coverage paths are **3** or **4** digits long. In Release 5, there can be up to 7500 coverage paths.
- **Digit to Insert/Delete** — Enter the leading digit that may be deleted and inserted back as described in the following text. The current PMS message set uses the extension number as the room identifier. In many customer configurations, the leading digit of the extension number is dropped to form the room number. In order to accommodate PMS devices that are based on room number and not extension, this leading digit may be deleted on messages from the PBX to the PMS, and then inserted back on messages from the PMS.



**NOTE:**

The PMS interface supports 3-, 4-, or 5-digit extensions, but prefixed extensions do not send the entire number across the interface. Only the assigned extension number is sent. Therefore, you should not use prefixed extensions for numbers that are also going to use the Digit to Insert/Delete function.

## Page 3 of the Form

- **Definition for Rooms in State 1 - 6** — The default is the Rooms in State number. You can enter up to 30 characters.

## Implementation Notes

---

One of four fields can appear after the **Announcement Type** field, depending on the data that is entered in the field. See the **Announcement Type** field description under “Page 2 of the Form.”



**CAUTION:**

*Do not set the time for the following reports to coincide when the server does its scheduled maintenance tests (usually at 1 a.m.). See the change*

*system-parameters maintenance screen to verify the time and coordinate this administration so the times do not overlap.*

The definitions for room states (page 3 of the form), are for Attendant Room Status only. If you are not using Attendant Room Status, you do not need to complete these fields.

```
change system-parameters hospitality                               Page 1 of 3
                        HOSPITALITY

                        Message Waiting Configuration: act-nopms
                        Controlled Restrictions Configuration: act-nopms
                        Housekeeper Information Configuration: act-nopms
                        Number of Housekeeper ID Digits: 0
                        Extension of PMS Log Printer:
                        Extension of Journal/Schedule Printer:
                        Client Room Coverage Path Configuration: act-nopms
                        Default Coverage Path for Client Rooms:
                        Forward PMS Messages to Intuity Lodging? n
                        PMS LINK PARAMETERS
                        Extension of PMS:
                        PMS Protocol Mode: transparent ASCII mode? n
                        Seconds before PMS Link Idle Timeout: 20
                        Milliseconds before PMS Link Acknowledgment Timeout: 500
                        PMS Link Maximum Retransmissions: 3
                        PMS Link Maximum Retransmission Requests: 3
                        Take Down Link for Lost Messages? y
```

**Screen 10-1. Hospitality Form (Page 1 of 3)**

Page 2 of 3

HOSPITALITY

Dual Wakeup?  
Room Activated Wakeup With Tones?  
Time of Scheduled Wakeup Activity Report: \_\_\_\_\_  
Time of Scheduled Wakeup Summary Report: \_\_\_\_\_  
Time of Scheduled Emergency Access Summary Report: \_\_\_\_\_

Announcement Type:

Length of Time To Remain Connected To Announcement: 30\_\_\_\_  
Extension To Receive Failed Wakeup LWC Messages: \_\_\_\_\_  
Routing Extension On Unavailable Voice Synthesis: \_\_\_\_\_  
Display Room Information in Call Display? n  
Number of Digits from PMS: 1  
PMS Sends Prefix? y  
Number of Digits in PMS Coverage Path: 3  
Digit to Insert/Delete:

Screen 10-2. Hospitality Form (Page 2 of 3)

Page 3 of 3

Definition for Rooms in State 1: Rooms in State 1  
Definition for Rooms in State 2: Rooms in State 2  
Definition for Rooms in State 3: Rooms in State 3  
Definition for Rooms in State 4: Rooms in State 4  
Definition for Rooms in State 5: Rooms in State 5  
Definition for Rooms in State 6: Rooms in State 6

Screen 10-3. Hospitality Form — (Page 3 of 3)



## Multimedia

# 11

---

This chapter contains multimedia features available on DEFINITY ECS. The multimedia administration forms are located at the end of each section.

| <b>Feature</b>   | <b>Page</b>           |
|--|-----------------------|
| <a href="#">Multimedia Applications Server Interface</a> | <a href="#">11-2</a>  |
| <a href="#">Multimedia Call Handling</a>                 | <a href="#">11-30</a> |

| <b>Form</b>                      | <b>Page</b>           |
|----------------------------------|-----------------------|
| <a href="#">Multimedia Forms</a> | <a href="#">11-39</a> |

## Multimedia Applications Server Interface

---

The Multimedia Applications Server Interface (MASI) defines a protocol and a set of operations that are used to extend DEFINITY feature functionality to a Multimedia Communications Exchange (MMCX) system. MASI architecture fits the client/server model, where the DEFINITY functions as a server for MMCX clients. Examples of DEFINITY features supported by MASI include Call Detail Recording (CDR), AUDIX/INTUITY voice mail integration, and AAR/ARS.

MMCX can make use of both MASI features, and MMCX autonomous features. Autonomous features are those that MMCX provides, even if MASI is not enabled. This document does not discuss them unless there is a consideration for MASI administration.

Some autonomous MMCX features:

- Basic Call (Place/Drop)
- Call Coverage
- Conference
- Transfer

DEFINITY/MASI features:

- Basic Call (Place/Drop) — DEFINITY tracks the status of all calls placed to or from a MASI terminal.
- Call Detail Recording — DEFINITY tracks calls to and from MASI terminals and can produce call records that indicate if a call uses MASI.
- Call Coverage — DEFINITY tracks MMCX calls that are sent to coverage. A DEFINITY coverage path can contain both MASI terminals and DEFINITY stations.
- Conference — DEFINITY tracks conference calls that involve MASI terminals, if a DEFINITY station originates the conference. Conferences that involve MASI terminals and DEFINITY stations are voice-only. If the DEFINITY station originates the call, the caller can use the consultative form of conference or transfer.
- World Class Routing (AAR or ARS) — Calls from MASI terminals can take advantage of DEFINITY ECS World Class Routing capabilities.
- Voice messaging access to AUDIX/INTUITY — MMCX users can take advantage of AUDIX voice messaging, and receive message waiting indication.
- MMCX trunking — By assigning DEFINITY trunk access codes to interfaces from the MMCX to other MMCXs or the PSTN, DEFINITY ECS can monitor traffic over those interfaces.



## Before you start

---

### CAUTION:

*DEFINITY ECS offers a wide range of features, and MMCX users may want to take advantage of this. In some cases, these features will operate as expected. However, some features are not supported for use over the MASI link, and their behavior is unpredictable. You may cause harm to your system by attempting to use these features. The Interactions section contains a list of features, and lists those features that are absolutely not supported for use with MASI. If you administer features on the DO NOT ADMINISTER list, Lucent Technologies cannot be responsible for the result.*

For purposes of administration, there are feature buttons and groups of users that you must not administer with MASI terminal extensions. There are also features that you simply cannot administer for a MASI terminal, because the software does not allow it.

## About this document

---

The following document describes the Multimedia Applications Server Interface, and provides instructions on how to set it up, including administration and monitoring. It also includes a section on troubleshooting.

You need to use both the DEFINITY system administration terminal (SAT) and the MMCX administration terminal to administer MASI. This document describes what you need to do at the DEFINITY SAT. It also occasionally mentions administration that you must do at the MMCX administration terminal. For more detailed MMCX information, see the *MMCX Technical Reference*.

## List of terms

---

This is a list of terms that are specific to MASI, or that have meanings in the context of MASI that are not standard.

- **chgmasi** — The command you use to administer MASI at the MMCX administration terminal.
- **Interserver** — Connections between MMCX terminals on different MMCX servers/nodes.
- **MASI domain** — A MASI domain consists of a DEFINITY and one or more MASI nodes that share the same dial plan. That is, the extension numbers on the MMCX are known to the DEFINITY, and fit in the DEFINITY dial plan.
- **MASI interworking** — MASI interworking refers to the completion of a voice connection within DEFINITY, involving at least one MASI terminal and a MASI path.
- **MASI link** — The connection between the MMCX and the DEFINITY ECS.

- **MASI node** — A single MMCX server. You may connect more than one MASI node to a DEFINITY. Each node has a separate number. This node number needs to be consistent whenever referring to a specific MMCX server.
- **MASI non-interworking** — MASI non-interworking refers to the completion of a call by MMCX, not involving a MASI path.
- **MASI path** — The ISDN B-channels between MMCX and DEFINITY in a MASI environment. Paths are used for voice and data connections between DEFINITY and MMCX.
- **MASI signaling link** — ISDN D-channel used to transport a new ISO protocol called the MASI protocol between the DEFINITY ECS and the MMCX.
- **MASI terminal** — The DEFINITY representation of MMCX terminals in a MASI environment.
- **MMCX interface** — PRI interface for connecting an MMCX server to other public, private or WAN switching systems or equipment that is part of the public network. Similar to a DEFINITY trunk group. These may include non-MASI trunks connecting the DEFINITY ECS and the MMCX.
- **MMCX trunk** — The DEFINITY representation of trunk or network facilities terminating on MMCX. For purposes of MASI, they are called “interfaces.”

## Planning for MASI

---

Before you start to administer MASI, you should make a plan for how to do it. Among the configurations on the following pages, there is probably one that matches the configuration of your system fairly closely. You might want to either write on these pages, or draw up your own configuration. It may help you if you have already determined trunk group and signaling group numbers, unused extensions, and so on. The following are things you need to consider:

- Establish the dial plan on the MMCX to agree with that of the DEFINITY ECS. If you use Universal Dial Plan and MMCX, you may need to make adjustments for the MMCX dial plan.
- Find unused extensions and trunk group numbers. You need:
  - one trunk group number for each ISDN-PRI connection to the MMCX
  - one signaling group number for each MASI node and an unused DEFINITY extension for the signaling group
  - one unused DEFINITY extension for the Near-End Path Termination number for all MASI Paths to this ECS. You can use the same number for all MASI nodes in the domain.
  - two unused MMCX extensions for the nearpath and tscnum arguments to the **chgmasi** command. This is the command you use to administer MASI on the MMCX.

## MASI configurations

There are several ways to set up combinations of MASI nodes and DEFINITY servers. The following figures depict several possible configurations.

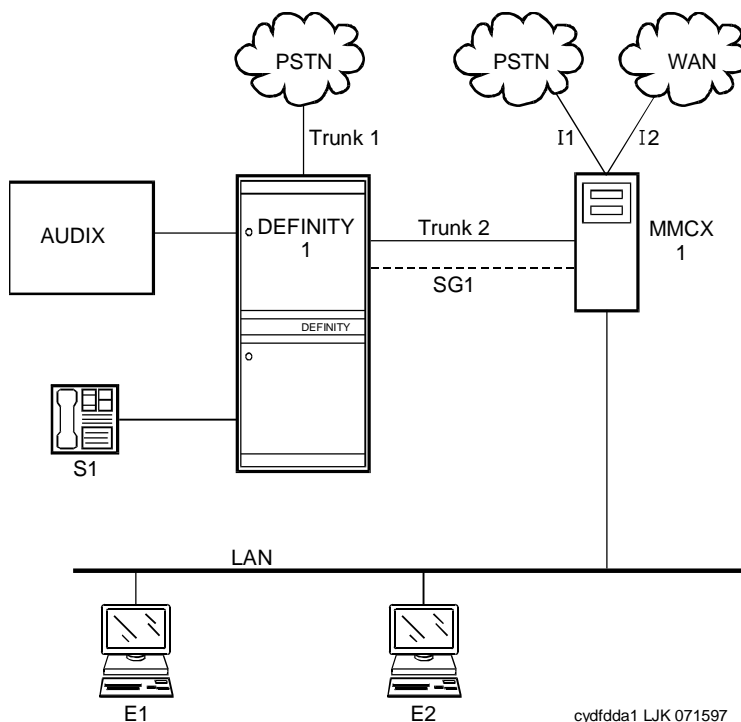

**Figure 11-1. MASI domain of one DEFINITY ECS and one MMCX**

The parts of this drawing, for MASI, are as follows:

- Trunk 1 — This is any type of trunk connection to the public network.
- Trunk 2 — This is the link between the DEFINITY ECS and the MMCX, and requires a TN464C or later DS1 circuit pack. You administer this link as an ISDN-PRI trunk group, a MASI path and an NCA-TSC.
- I1 and I2 — These are MMCX interfaces to destinations other than DEFINITY. Administer as MASI trunks.
- E1 and E2 — Endpoints (terminals) belonging to the MMCX. Administer as MASI terminals.
- MMCX — Determine a node number for each MMCX server. This can be any number from 1–15. Once established, DEFINITY informs the MMCX of its node number.

- S1 — DEFINITY station.

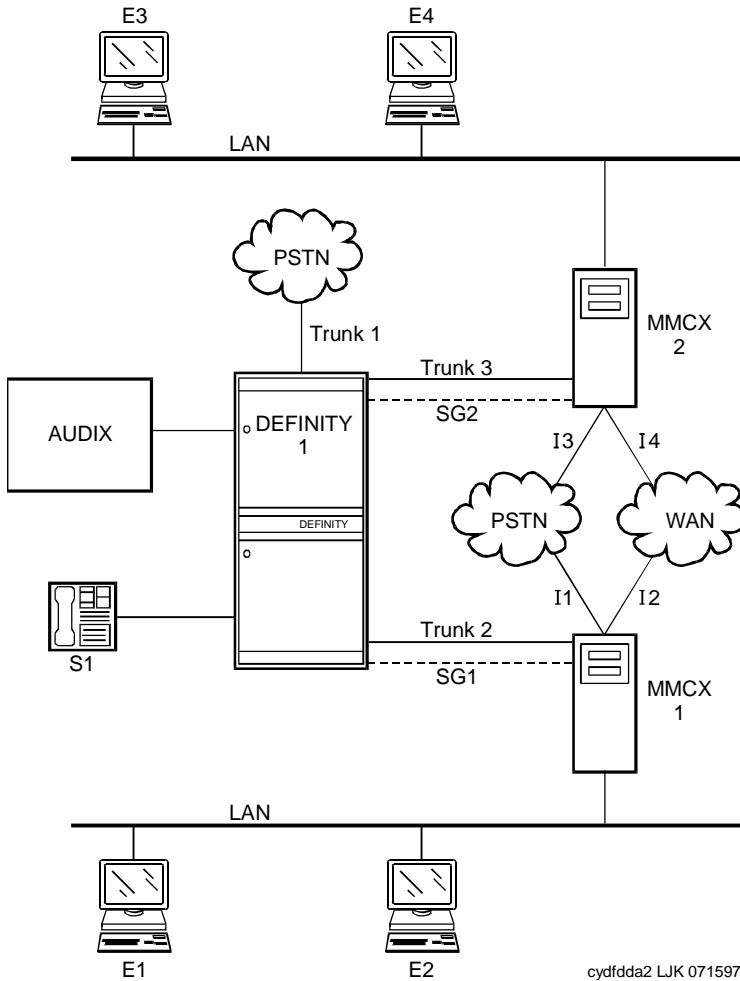

Figure 11-2. MASI domain of one DEFINITY and two (or more) MMCXs

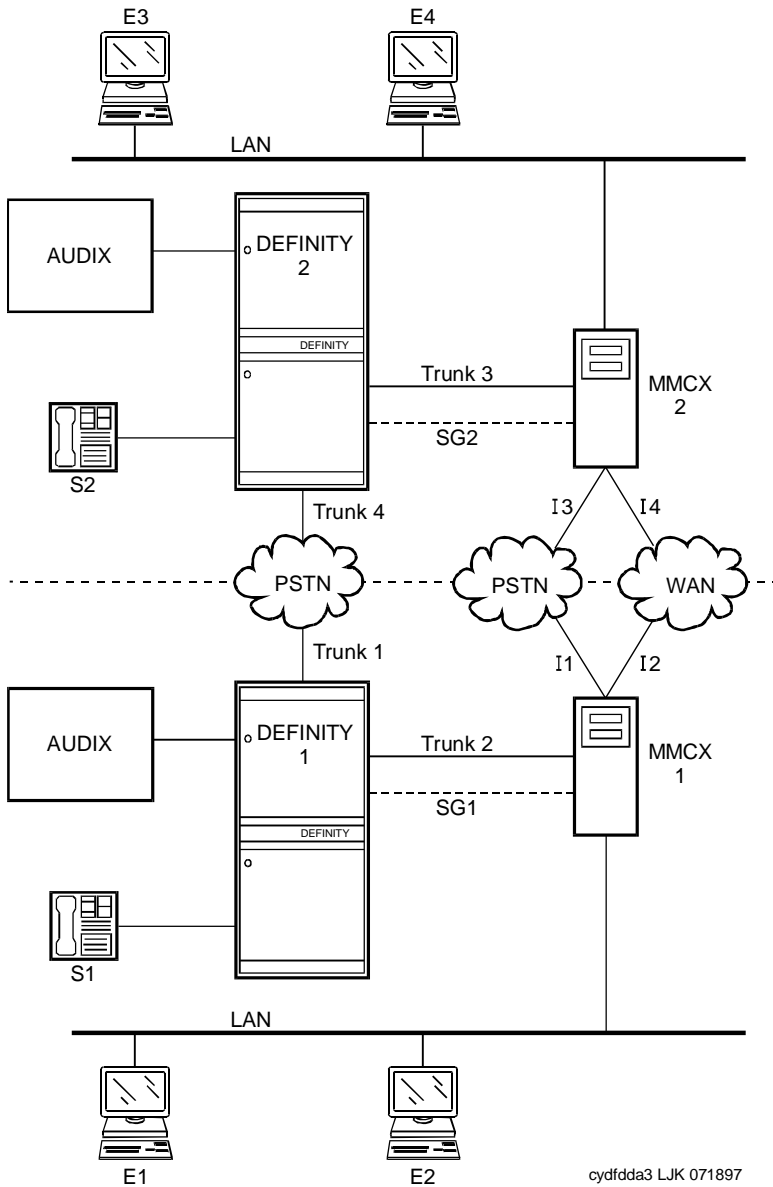

Figure 11-3. Two separate MASI domains

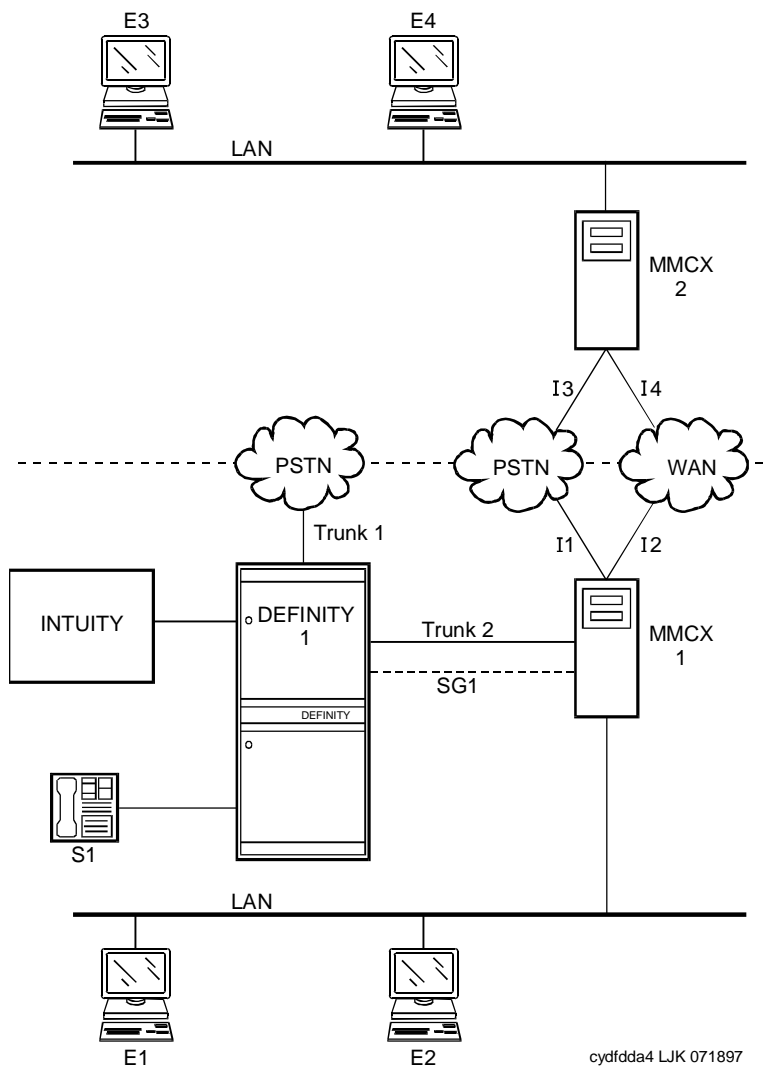

Figure 11-4. One MASI domain, and one non-MASI MMCX

The MASI node must be directly connected to the DEFINITY ECS for MASI features to work. In this configuration, terminals that belong to MMCX 2 (E3 and E4), do not take advantage of MASI capabilities.

## How to administer MASI

This section discusses the administration required to make MASI work. You perform most of this administration from the DEFINITY SAT. However, there are a few things you must do at the MMCX administration terminal. This section sometimes refers to the **chgmasi** command. This is the command you use to administer MASI parameters on the MMCX. For more information about using the chgmasi command, refer to your *MMCX Technical Reference*.

### Step 1 — Establish customer options (Lucent Technologies)

A Lucent Technologies representative must activate MASI using the System-Parameters Customer-Options form. The representative should also verify that ISDN-PRI (R6r and later configurations) or ISDN-PRI over PACCON (R6vs/si/csi and later configurations), and AAR/ARS are enabled. The value of the G3 Version field must be V5 or higher. The actual software load must be R6.1 or higher.

On the MMCX, MASI must be enabled using the **chgmasi** command.

### Step 2 — Establish maintenance parameters and alarming options (Lucent Technologies)

Ensure that the Maintenance-Related System Parameters form, Packet Bus Activated field = y.

Using the **set options** command (Lucent Technologies init or inads logins only), set MASI alarming options. For more information, see *DEFINITY ECS Maintenance* for the appropriate model.

### Step 3 — Establish the physical connection

Establish the physical connection between the DEFINITY ECS and the MMCX. For more information about installing the cables, see *Installation for Adjuncts and Peripherals*.

### Step 4 — Administer circuit pack

Using the DS1 Circuit Pack form, verify that the DS1 circuit pack you use to establish the MASI link is administered as follows:

- Bit Rate = 1.544
- Line Coding = b8zs
- Line Compensation = 1
- Signaling Mode = isdn-pri
- Interface = network

- Country Protocol = 1
- Protocol Version = a

### Step 5 — Administer a signaling group

For each MASI node, you need to establish a unique signaling group. Use the command **add signaling-group xxx** to access the Signaling Group form.

Page 1 of 5

SIGNALING GROUP

Group Number: \_      Associated Signaling? y      Max number of NCA TSC: \_\_

Primary D-Channel: \_\_\_\_\_      Max number of CA TSC: \_\_

Trunk Group for Channel Selection: \_\_      Trunk Group for NCA TSC: \_\_

#### Screen 11-1. Signaling Group Form (Page 1 of 5)

For each link, establish a Non-Call Associated Temporary Signaling Connection (NCA-TSC) with the following attributes:

- **Associated Signaling** — MASI requires Facility Associated Signaling, so this field must be set to y.
- **Primary D-channel** — Enter a 6- to 7-character port number associated with the DS1 Interface circuit pack port. The port address of the PRI that carries D-channel signaling.

The entry breaks down as follows:

| Characters | Meaning        | Value                                  |
|------------|----------------|--|
| 1-2        | Cabinet Number | 1 – 44 (R5r and later configurations)  |
|            |                | 1 – 3 (R5si and later configurationsi) |
|            |                | 1 (R5vs and later configurations)      |
| 3          | Carrier        | A – E                                  |
| 4-5        | Slot Number    | 01 – 20                                |
| 6-7        | Port           | 16 or 24                               |

The port number is used to assign the primary D-channel in the Signaling Group. For 24-channel facilities, the 24th port is assigned as the D-channel. For 32-channel facilities, the 16th port is assigned as the D-channel.



11 Multimedia

Multimedia Applications Server Interface

- **Max Number of NCA TSC** — For MASI, this must be 1.
- **Max number of CA TSC** — Leave the default of 0.
- **Trunk Group For NCA TSC** — This can be left blank.
- **Trunk Group for Channel Selection** — This can be left blank.

| ADMINISTERED NCA TSC ASSIGNMENT |            |         |  |              |       |          | Page 2 of 5 |
|---------------------------------|------------|---------|--|--------------|-------|----------|-------------|
| Service/Feature: _____          |            |         | As-needed Inactivity Time-out (min): _____ |              |       |          |             |
| TSC Index                       | Local Ext. | Enabled | Established                                | Dest. Digits | Appl. | Mach. ID |             |
| 1:                              | _____      | -       | _____                                      | _____        | _____ | _____    |             |
| 2:                              | _____      | -       | _____                                      | _____        | _____ | _____    |             |
| 3:                              | _____      | -       | _____                                      | _____        | _____ | _____    |             |
| 4:                              | _____      | -       | _____                                      | _____        | _____ | _____    |             |
| 5:                              | _____      | -       | _____                                      | _____        | _____ | _____    |             |
| 6:                              | _____      | -       | _____                                      | _____        | _____ | _____    |             |
| 7:                              | _____      | -       | _____                                      | _____        | _____ | _____    |             |
| 8:                              | _____      | -       | _____                                      | _____        | _____ | _____    |             |
| 9:                              | _____      | -       | _____                                      | _____        | _____ | _____    |             |
| 10:                             | _____      | -       | _____                                      | _____        | _____ | _____    |             |
| 11:                             | _____      | -       | _____                                      | _____        | _____ | _____    |             |
| 12:                             | _____      | -       | _____                                      | _____        | _____ | _____    |             |
| 13:                             | _____      | -       | _____                                      | _____        | _____ | _____    |             |
| 14:                             | _____      | -       | _____                                      | _____        | _____ | _____    |             |
| 15:                             | _____      | -       | _____                                      | _____        | _____ | _____    |             |
| 16:                             | _____      | -       | _____                                      | _____        | _____ | _____    |             |

Screen 11-2. Administered NCA TSC Assignment page of the Signaling Group form

- **Service/Feature** — Leave blank.
- **As-needed Inactivity Time-out (min)** — This field only applies to as-needed NCA-TSCs. Since MASI requires a permanent connection, leave blank.
- **TSC Index** — This display-only field specifies the administered NCA-TSCs assigned.
- **Local Ext** — Enter a valid, unassigned DEFINITY ECS extension. This extension does not need a port assignment and does not need to correspond to any other administration.
- **Enabled** — Enter y to enable the administered NCA-TSC. You may want to wait to enable this link until all other administration is in place. If this is y, DEFINITY ECS attempts to establish the connection as soon as you submit the form. This may cause your system to alarm, if other administration is not finished.
- **Establish** — Used to indicate the strategy for establishing this administered NCA-TSC. Enter **permanent** for MASI.

- **Dest. Digits** — A valid MMCX extension. This must correspond to the value of the *tscnum* argument to the **chgmasi** command.



**NOTE:**

These digits are sent as entered to the destination MMCX; no routing or other digit manipulation is performed.

- **Appl.** — Specifies the application this administered NCA-TSC is going to be used for. Enter **masi**.
- **Machine ID** — Used to indicate the MASI node to which this administered NCA-TSC is connected. This number should be the same as the MASI node number found on other forms.

### How to list TSCs or determine status of the TSC

To determine which TSCs are designated for MASI, use the **list masi tsc** command.

| MASI TEMPORARY SIGNALING CONNECTIONS (TSC) |                |           |            |         |             |                      |          |
|--|----------------|-----------|------------|---------|-------------|----------------------|----------|
| Sig. Grp                                   | Primary D-Chan | TSC Index | Local Ext. | Enabled | Established | Dest. Digits         | Mach. ID |
| xxx  | xxxxxxxx       | xxx       | xxxxx      | x       | xxxxxxxx    | xxxxxxxxxxxxxxxxxxxx | xx       |
| xxx  | xxxxxxxx       | xxx       | xxxxx      | x       | xxxxxxxx    | xxxxxxxxxxxxxxxxxxxx | xx       |
| xxx  | xxxxxxxx       | xxx       | xxxxx      | x       | xxxxxxxx    | xxxxxxxxxxxxxxxxxxxx | xx       |

Screen 11-3. MASI Temporary Signaling Connections (TSC) Display

This command displays the following:

- **Sig Grp** — The number of the signaling group to which this TSC belongs
- **Primary D-Channel** — Port location of the Primary D-channel
- **TSC Index** — The number of the MASI TSC within the signaling group
- **Local Ext.** — DEFINITY extension associated with the TSC
- **Enabled** — Indicates the state of the connection - enabled (y/n)
- **Established** — Value of established flag (as-needed/permanent)
- **Dest. Digits** — The MMCX extension that indicates the TSC destination
- **Mach. ID** — MASI node number

Once you establish and enable the signaling group, you need to verify that it is active. Use the command **status signaling-group signaling-group#** or **status**

**tsc-administered signaling-group# [/tsc-index] [print]** to determine if the link is active.

### Step 6 — Administer ISDN-PRI trunk group

Use the command **add trunk-group xxx** to access the Trunk Groups form. For a more detailed description of the ISDN-PRI trunk group, see [“ISDN-PRI trunk group” on page 7-219](#).

Establish an ISDN-PRI trunk group with the following attributes:

#### Page 1

- Group Type = isdn-pri
- TAC = valid TAC that conforms to your existing dial plan
- Direction = two-way
- Service Type = tie
- CDR Reports = n

You must also administer the PRI link from the MMCX to the ECS, using the MMCX administration terminal. See the *MMCX Technical Reference* for information on the **addpri** command.

### Step 7 — Administer MASI Path Parameters

Use the **change masi path-parameters** command to access the MASI Path Parameters form.

MASI PATH PARAMETERS

Near-End Path Extension: \_\_\_\_\_

| MASI Node | Trunk Group | Far-End Path Termination Number |
|-----------|-------------|---------------------------------|
| 1         | —           | _____                           |
| 2         | —           | _____                           |
| 3         | —           | _____                           |
| 4         | —           | _____                           |
| 5         | —           | _____                           |
| 6         | —           | _____                           |
| 7         | —           | _____                           |
| 8         | —           | _____                           |
| 9         | —           | _____                           |
| 10        | —           | _____                           |
| 11        | —           | _____                           |
| 12        | —           | _____                           |
| 13        | —           | _____                           |
| 14        | —           | _____                           |
| 15        | —           | _____                           |

Screen 11-4. MASI Path Parameters form

Establish a MASI Path with the following attributes:

- **Near-End Path Extension** — An unassigned DEFINITY extension. When using the **chgmasi** command to administer the MMCX, this is the farpath extension. See the *MMCX Technical Reference* for more information.
- **MASI Node** — The node number for the MMCX. For each MMCX/MASI node, this number must be the same everywhere it occurs (signaling group, masi trunk group, and masi terminal forms).
- **Trunk Group** — This is the DEFINITY trunk group number for the ISDN-PRI trunk that will be used to establish call paths.
- **Far-End Path Termination Number** — This is an unassigned MMCX extension. When using the **chgmasi** command to administer the MMCX, this is the nearpath extension. See the *MMCX Technical Reference* for more information.

## Step 8 — Administer MASI trunk groups

You use the MASI trunk group form to define MMCX interfaces that interconnect MASI nodes, or that connect MMCX nodes to another private switch or central office. Examples of MMCX interfaces include:

- PRI trunks linking MMCX servers
- PRI trunks linking MMCX to the PSTN
- PRI trunks from MMCX to DEFINITY that are used for purposes other than MASI
- LAN interfaces linking MMCX servers

Use the command **add masi trunk-group xxx (or 'next')** to access the MASI Trunk Group form. The trunk group number must not be assigned, and you cannot exceed the maximum total trunks for your system. Valid values for xxx are unused DEFINITY trunk group numbers between 1–96 for R6vs/si/csi and later configurations, and 1–120 for R6r and later configurations.

```

MASI TRUNK GROUP
Group Number: 15
Group Name: INCOMING CALL_____ COR: 1_ TN: 1 CDR Reports? y TAC: 915_
MASI Node Number: _ Remote Group Number: _
```

### Screen 11-5. MASI Trunk Group Form

- **Group Number** — This field displays the MASI trunk group number. This is the number assigned when executing the **add masi trunk-group** command.
- **CDR Reports** — Valid entries are “y,” “n,” and “r.” Default is “y.”
  - If you enter “y,” CDR records will be generated by completed outgoing calls terminated on this trunk group. If incoming calls are being recorded (the Record Outgoing Calls Only field on the CDR System Parameters form is set to “n”), then a single CDR record will be generated for answered calls with the call duration.
  - If you enter “n,” no CDR records will be generated by calls originated by or terminated on this trunk group.
- **Group Name** — Enter a unique name that identifies the trunk group. Up to 27 characters can be used; default is “INCOMING CALL.”
- **COR** — Enter a class of restriction (COR) number (0–95) that reflects the desired restriction; default is “1.”
- **TN** — This field displays the Tenant Partition number. For R6 and later configurations, all MASI trunks are associated with Tenant 1.
- **TAC** — Enter the trunk access code (TAC) that identifies the trunk group on CDR reports. You must assign a different TAC to each MMCX interface. Valid entries conform to the dial plan (1–4 digits, \* and # are valid first digits).
- **MASI Node Number** — The node number assigned to this MMCX machine.
- **Remote Group Number** — This is the number of the remote trunk group. For ISDN-PRI interfaces, valid values are any number 1–8; for LAN or WAN calling interfaces, the value must be 9. The combination of MASI Node Number and Remote Group Number must be unique. Remote group number corresponds to the group number on the MASI node.

### How to view a list of all MASI trunk groups

To view a list of all the MASI trunks administered on the ECS, use the command **list masi trunk-group**.

```

                                     MASI TRUNK GROUP
Group Number  TAC  Group Name                               Node  Remote
Number       TAC  Group Name                               Number Grp No.  CDR  COR  TN
xxx         xxxx  xxxxxxxxxxxxxxxxxxxxxxxxxxxxxxxxxxxxxxxx  xx    x        x   xx  xxx

```

Screen 11-6. List masi trunk-group output

### How to determine the status of MASI trunk groups

To determine the status of a specific MASI trunk, use the command **status masi trunk-group xxx**, where xxx is the trunk group number. This command provides descriptive information about the trunk, and the number of currently active trunk calls.

```

                                     MASI TRUNK GROUP STATUS
Group Number: xxx           Number of Active MMCX Trunk Calls: xxx
MASI Node Number: xx
Remote Group Number: xxx

```

Screen 11-7. Status masi trunk-group output

### Step 9 — Administer MASI terminals

Use the **add masi terminal xxxxx** or **next** command to administer each MASI terminal as a MASI terminal. You use available extensions on the ECS, so they need to conform to DEFINITY ECS dial plan. The extension must match the

DEFINITY dial plan, and for the add command, the extension must not already be in use. The extension of the MASI terminal must match the number of the MASI terminal.

DEFINITY users dial the MASI Terminal Extension to reach MMCX users.

 **NOTE:**

Anytime you add a terminal or other extension to the MMCX, you must administer a corresponding MASI terminal on DEFINITY. If you do not, you will not be able to dial this extension from DEFINITY.

```

                                MASI TERMINAL

Extension: 1000                                BCC: 0
                                                MASI Node Number:  TN: 1_
                                                COR: 1_

Name: _____

TERMINAL OPTIONS

Send Display Info? y
    
```

Screen 11-8. MASI Terminal Form — page 1

- **Extension** — This field displays the extension that you entered on the command line.
- **BCC** — This field displays the bearer capability class of the terminal, and identifies the type of traffic the terminal supports. For MASI, this is always 0, for voice or voice-grade data.
- **MASI Node Number** — The number of the node on which this terminal resides.
- **TN** — The tenant partition in which this terminal resides. At present, all MASI terminals must reside within tenant 1. This field is display-only, and always 1.
- **COR** — The class of restriction associated with this terminal.
- **Name** — The name associated with the terminal. This can be any alphanumeric string up to 27 characters.
- **Send Display Info** — Indicates whether DEFINITY should forward display information associated with a call. Set to y.

```

                                     MASI TERMINAL

FEATURE OPTIONS
  LWC Reception: none___

  CDR Privacy? n

                                     AUDIX Name: _____
```

Screen 11-9. MASI Terminal form — page 2

- **LWC Reception** — This field indicates whether the terminal can receive Leave Word Calling messages. Valid values are none, audix, and spe (for R6r and later configurations) or mas-spe (for R6vs/si/csi and later configurations). SPE-based LWC is not supported for MASI terminals. However, if DEFINITY AUDIX is used without a Data Control Link, you must administer MASI terminals to receive SPE-based LWC messages. For such cases, the LWC feature is used by AUDIX to activate and deactivate message waiting lamps on MASI terminals.
- **CDR Privacy** — Indicates whether CDR Privacy is supported for this terminal. See [“Call Detail Recording” on page 4-167](#) for more information.
- **AUDIX Name** — This field only appears on R6r and later configurations. This field contains the name of the AUDIX adjunct for LWC messages. If LWC reception field is set to audix, this field must contain a name. The name must match a machine name on the Adjunct Names form.

```

                                     MASI TERMINAL

SITE DATA
  Room: _____
  Jack:  _____
  Cable: _____
  Floor: _____
  Building: _____

BUTTON ASSIGNMENTS
  1: call-appr
```

Screen 11-10. MASI Terminal Form — page 3



- **Room** — Enter up to 10 characters to identify the MASI terminal location. This field may be blank.
- **Jack** — Enter up to 5 characters to identify the location where the MASI terminal is connected. This field may be left blank.
- **Cable** — Enter up to 5 characters to identify the cable that connects the MASI terminal to the system. This field may be left blank.
- **Floor** — Enter up to 7 characters to identify the floor where the MASI terminal is located.
- **Building** — Enter up to 7 characters to identify the building where the MASI terminal is located. Valid entries are listed in the site table.
- **Button Assignments** — This field contains a call appearance button and is display only.

### Duplicate masi terminal

Once you have one MASI terminal administered to your liking, you can use the **duplicate masi terminal** command to administer other stations with the same characteristics.

| MASI TERMINAL |       |       |       |       |
|---------------|-------|-------|-------|-------|
| Ext           | Name  | Room  | Jack  | Cable |
| 77777         | _____ | _____ | _____ | _____ |
| 77778         | _____ | _____ | _____ | _____ |
| 77779         | _____ | _____ | _____ | _____ |
| 77781         | _____ | _____ | _____ | _____ |
| 77782         | _____ | _____ | _____ | _____ |
| 77783         | _____ | _____ | _____ | _____ |
| _____         | _____ | _____ | _____ | _____ |
| _____         | _____ | _____ | _____ | _____ |
| _____         | _____ | _____ | _____ | _____ |
| _____         | _____ | _____ | _____ | _____ |
| _____         | _____ | _____ | _____ | _____ |
| _____         | _____ | _____ | _____ | _____ |
| _____         | _____ | _____ | _____ | _____ |
| _____         | _____ | _____ | _____ | _____ |
| _____         | _____ | _____ | _____ | _____ |

Screen 11-11. Duplicate MASI Terminal form

### How to list and status MASI terminals

To view a list of all the MASI terminals administered on the ECS, use the command **list masi terminals**. This command only lists terminals within the domain of the DEFINITY ECS from whose SAT you issue the command.

11 Multimedia

Multimedia Applications Server Interface

```

                                MASI TERMINALS

Ext      Name                               Node
                                Number CDR  COR  TN
xxxxxx  xxxxxxxxxxxxxxxxxxxxxxxxxxxxxxxx  xx   x   xx  xxx
xxxxxx  xxxxxxxxxxxxxxxxxxxxxxxxxxxxxxxx  xx   x   xx  xxx
xxxxxx  xxxxxxxxxxxxxxxxxxxxxxxxxxxxxxxx  xx   x   xx  xxx
xxxxxx  xxxxxxxxxxxxxxxxxxxxxxxxxxxxxxxx  xx   x   xx  xxx

```

Screen 11-12. List MASI Terminal output

To view the active or idle status of a specific MASI terminal, use the command **status masi terminal (extension)**.

```

                                GENERAL STATUS

                                TYPE: MASI      Service State: active
                                Extension: 54001
MASI Node Number: 14

```

Screen 11-13. Status masi terminal command

To determine which extension you assigned as the MASI Near-End Path Termination extension, use the command **list extension-type**. This command displays the extension number and type (attendant, masi-terminal, etc.), as well as other information about the extension.

| EXTENSION TYPE |                     |      |      |      |      |             |
|----------------|---------------------|------|------|------|------|-------------|
| Ext            | Type                | Name | COR  | TN   | COS  | Cv1/<br>Cv2 |
| ----           | ----                | ---- | ---- | ---- | ---- | ----        |
| 1234           | masi-terminal       |      | 1    | 1    | 1    |             |
| 4077           | term-masi-path-call |      |      |      |      |             |

Screen 11-14. List extension type

Step 10 — Administer features

**AAR/ARS**

1. AAR/ARS is an optional feature on DEFINITY, and you need to purchase this option to use it with MMCX. To verify that this feature is enabled, use the command **display system-parameters customer-options**. If it is not enabled, call your Lucent Technologies representative.
2. The MMCX dial plan must use the same feature access codes as the DEFINITY ECS. If this is not already the case, modify the MMCX dial plan using the **chgdp** command. See the *MMCX Technical Reference* for more information.
3. Include this feature access code in the **chgmasi** command.

**CDR**

1. To get call detail records for calls over MMCX interfaces, set CDR Reports = y on the MASI Trunk Group form.
2. To get call records for calls over the ISDN-PRI trunk group, set CDR Reports = y on the ISDN-PRI Trunk Group form.
3. To track calls between a MASI terminal and other MASI terminals or DEFINITY stations, enter the MASI terminal extension on the Intraswitch CDR form.
4. Enter n in the Record Non-Call Assoc TSC field on the CDR System Parameters form.

**⇒ NOTE:**

If you use the same PRI trunks for MASI and non-MASI calls, it is strongly recommended that you do not enable CDR for these calls. Establish a separate trunk group for non-MASI calls and set CDR Reports = n.

## Coverage

To establish coverage from a MASI terminal to AUDIX:

1. Use the MMCX user interface to enter the AUDIX hunt group extension as the coverage point. You cannot use DEFINITY coverage administration for MASI terminals.
2. If AUDIX ports are not administered on DEFINITY, do so.
3. Set up the MASI terminal as an AUDIX subscriber. Enter the MASI terminal extension in the extension field on the Subscriber Administration form.

To establish coverage from a MASI terminal to another MMCX terminal or DEFINITY station:

1. Use the MMCX user interface to enter the desired extension as the coverage point for the MASI terminal. You cannot use DEFINITY coverage administration for MASI terminals.

## Step 11 — Verify administration

Make test calls from DEFINITY to MMCX, ensure that you can indeed place and receive calls.

Call an unattended MASI terminal. Verify that the call goes to AUDX. Retrieve the call from the MASI terminal. Verify that all works as expected.

## MASI command permissions

If you are the super-user for your system, you can restrict other administrative logins from changing MASI administration. To do this, use the **change permissions (login-ID)** command. Enter y in the Additional Restrictions field, then move to the Restricted Object List page of the form.

You may restrict the following MASI-related objects:

- masi-path-parameters
- masi-terminal
- masi-trunk-group
- masi-tsc

## Detailed description of features

### AAR/ARS

MMCX can take advantage of advanced routing features for voice-only calls to the PSTN or a DEFINITY system private network. Users must enter the AAR/ARS access code before the rest of the dialed digits. MASI will route the call over the DEFINITY private network (AAR) or the public network (ARS), based on the digits supplied by the MMCX user.

Routing patterns must contain only trunk groups that actually terminate on the DEFINITY ECS. Calls from one MMCX to another do not use AAR/ARS. Authorization codes are not supported.

### Call Detail Recording

Using the MASI link, DEFINITY is able to track call detail information for calls made using MMCX terminals and interfaces. CDR records all calls originating from or terminating at a MASI terminal. MASI CDR does not record ineffective call attempts when all MASI paths are busy.

The Resource Flag value of 8 indicates a MASI call. This field appears in unformatted, int-isdn, expanded and customized CDR formats. For formats other than these, you can determine that a call involves a MASI terminal or trunk by the TAC, dialed number or calling number fields.

The following are the CDR capabilities of MASI. Administration information is under the heading [“How to administer MASI” on page 11-9](#).

- Incoming/Outgoing Trunk Call Splitting  
Call splitting does not produce separate records for MMCX calls that are transferred or conferenced.
- Intraswitch CDR  
You can administer intraswitch CDR to monitor MASI terminals. To do this, simply add the MASI terminal extension on the Intraswitch CDR form. DEFINITY then monitors calls from MASI terminals to other MASI terminals, and calls between MASI terminals and DEFINITY stations.
- CDR Privacy  
You can administer a MASI terminal for CDR Privacy.
- Account Code Dialing and Forced Entry of Account Codes  
This is not supported for MASI terminals. Therefore, make sure the COR you assign does not force entry of account codes.
- Trunk CDR  
You can get call detail records for all incoming and outgoing calls made over MMCX interfaces.

## Call redirection / Voice-messaging access

MMCX users can enter a DEFINITY extension, including an AUDIX hunt group, Callmaster agent, attendant console or voice terminal as their coverage point.

If AUDIX is established as the MASI terminal's coverage point, the MASI terminal receives message waiting indication, and dials the AUDIX hunt group extension to retrieve messages. Once connected to AUDIX, operation for the MMCX user is the same as for a DEFINITY station user, including use of # to identify the extension, if desired.

### NOTE:

It is not possible to determine the call coverage status of a MASI terminal.

DEFINITY tracks calls to MASI terminals that follow the autonomous coverage path from the MASI terminal. MMCX calls redirected to DEFINITY stations contain display information.

MASI terminals that dial AUDIX directly, or that place calls to MASI terminals that cover to AUDIX, do not receive ringback if all AUDIX ports are busy. Instead, these callers see a message that the called party is busy, and the call drops.

## Transfer

MASI terminals cannot transfer calls to DEFINITY stations, and cannot transfer a call to another MASI terminal if the call involves a DEFINITY station.

## Conferencing

Conferences can involve both MASI terminals and DEFINITY stations, and either one may initiate the conference. DEFINITY stations participate in such conferences in voice-only mode. If an MMCX user initiates a conference that involves DEFINITY stations, the conference will drop when the initiator drops from the call. If a DEFINITY station initiates the conference, that station may drop without affecting the other conferees.

## Status tracking - terminals and trunks

DEFINITY tracks the active/idle status of all MASI terminals, and monitors traffic over MMCX interfaces.

## Trunk groups

For MASI purposes, there are two kinds of trunk groups: the ISDN-PRI trunk groups that serve as paths for establishing calls between DEFINITY stations or trunks and MASI terminals or interfaces, and the remote trunks that are interfaces from the MMCX to other entities. Each MASI remote trunk group appears to DEFINITY as a single unit, with no concept of members within the group.

 **NOTE:**

You cannot test, busy out, or release MASI remote trunk groups, since you cannot dial a MASI remote trunk TAC from DEFINITY. The TAC merely identifies the trunk to DEFINITY for status and CDR.

You cannot administer MASI trunks as part of DEFINITY route patterns.

## Interactions & Unsupported Features

We can generalize feature interactions to some extent. For example, since there are no buttons available to a MASI terminal, any feature that requires a button is also not available. MASI cannot support features that require the user to dial a trunk access code for a MASI remote trunk, or a feature access code other than AAR/ARS. The MMCX dial plan may contain only those feature access codes that are supported.

 **CAUTION:**

*DO NOT ADMINISTER the following features! The following features are not supported for use over the MASI link, and Lucent Technologies cannot responsible for the results if you attempt to administer them.*

### Unsupported Call Center features

- ASAI — You must not administer a MASI terminal in an ASAI domain. MASI terminals and MMCX trunks are not monitored by ASAI. It may be possible for a MASI terminal to place a call to a DEFINITY station that is part of an ASAI domain. ASAI will not be blocked from controlling this call, but there may be unpredictable results. The same is true for calls originating from an ASAI domain terminating at MASI terminals, and for ASAI-monitored hunt groups that contain MASI terminals.
- Automatic Call Distribution — You must not include a MASI terminal extension as part of an ACD hunt group. You must not mix MASI administration with anything related to ACD, including Outbound Call Management and PASTE.
- Call Vectoring — You must not include MASI terminal extensions in any step of a vector.

### Unsupported Basic features

- Bridged Call Appearances — You must not administer a bridged appearance that involves a MASI terminal.
- Call Coverage — You must not administer a MASI terminal in a DEFINITY station's coverage path.
- Call Forwarding — You must not forward a DEFINITY station to a MASI terminal.

## 11 Multimedia

### Multimedia Applications Server Interface

Page 11-26

- Call Pickup — You must not administer a MASI terminal as part of a pickup group.
- Intercom — You must not administer MASI terminals as members of any type of intercom group.
- Manual Message Waiting — You must not administer a manual message waiting button (man-msg-wt) with a MASI terminal as the referenced extension.
- Manual Signaling — You must not administer a manual signaling button (signal) with a MASI terminal as the referenced extension.
- Night Service — You must not administer a MASI terminal as a night service destination.
- Pull transfer — MASI terminals cannot perform a pull transfer operation. You must not administer this feature on an ECS where MASI is active. This applies only in Italy.
- Station Hunting — You must not administer a MASI terminal as part of a station hunting path.
- Terminating Extension Groups — You must not administer a MASI terminal as part of a TEG.

### Other interactions

The following section describes feature behaviors that may not be as expected, but that are not likely to be destructive.

#### Attendant features

- Dial Access to the Attendant — MASI terminals will be able to dial the attendant access code, if it is administered in the MMCX dial plan.
- Attendant Direct Extension Selection — Attendants are able to access MASI terminals via DXS buttons and busy lamp indicates status of the MASI terminal.
- Emergency Access to the Attendant — MASI terminals have emergency access using the attendant access code, if it is administered in the MMCX dial plan. However, off-hook alerting is not administrable.
- Attendant Intrusion — Attendants are able to activate intrusion towards MASI terminals.
- Attendant Override — Attendants are not able to activate override towards MASI terminals.
- Attendant Recall — MASI terminals cannot activate attendant recall.
- Attendant Remote Trunk Group Select — Attendants cannot use this feature to select MASI remote trunks.
- Attendant Return Call — Operates normally if a MASI terminal is the called party.



- Attendant Serial Call — Serial calls are denied if the calling party is an MMCX interface.
- Attendant Straightforward Outward Completion — The attendant is able to complete calls to DEFINITY trunks for MASI terminals.
- Attendant Through Dialing — The attendant can use Through Dialing to pass dial tone to MASI terminals.
- Attendant Timers — Attendant timers work the same no matter what kind of terminal is involved.
- Attendant Trunk Group Busy/Warning Indicators — You cannot administer Busy/Warning indicators for MASI trunks because they are not standard DEFINITY trunks. However, you can administer these indicators for the trunk group administered for MASI paths.
- Attendant Trunk Identification — The attendant is not able to identify the trunk name via button pushes.

### Basic features

- Abbreviated Dialing — A DEFINITY station can enter an MMCX extension in an AD list. However, MASI terminals cannot use AD.
- Administered Connections — MASI terminals must not be the originator nor the destination of an administered connection.
- Automatic Callback — Automatic callback does not work towards a MASI terminal.
- Automatic Circuit Assurance — You must not administer a MASI terminal as an ACA referral destination. You cannot administer ACA for MASI remote trunks.
- Busy Verification of Terminals and Trunks — You cannot use Busy Verification for MASI terminals or remote trunks.
- Call Detail Recording — CDR Account Code Dialing and Forced Entry of Account Codes are not supported for MASI terminals. See Call Detail Recording in Detailed Description for more information.
- Call Park — The attendant can park calls at the extension of a MASI terminal, but users can only retrieve these calls from a DEFINITY station, since MASI terminals cannot dial the Answer Back FAC.
- Data Call Setup — DEFINITY users cannot place data calls to MASI terminals.
- Facility Busy Indication — You can use FBI to track the status of MASI terminals. The FBI button and indicator lamp must be on a DEFINITY station. You cannot use FBI to track MMCX interfaces.
- Facility Test Calls — DEFINITY users cannot make test calls to MMCX interfaces.
- Go to Cover — MASI terminals cannot activate this feature.

## 11 Multimedia

### *Multimedia Applications Server Interface*

Page 11-28

- Leave Word Calling — The only valid LWC destination for a MASI terminal is AUDIX. You cannot administer SPE-based LWC. MASI terminals cannot send LWC messages to DEFINITY stations or MASI terminals.
- Loudspeaker paging — You can administer a MASI terminal as a code calling extension.
- Malicious Call Trace — MASI terminals cannot initiate malicious call trace.
- Message Retrieval — MMCX users can only retrieve messages through AUDIX.
- Music on Hold — Music on hold will only be available if a DEFINITY station has placed the call on hold.
- Override — Executive override does not work towards MASI terminals.
- Priority Calling — Priority calling is not supported for calls to or from MASI terminals.
- Ringback Queueing — Ringback Queueing is not supported for MASI terminals.
- Send All Calls — MMCX has an autonomous SAC function. See Call Redirection for more information.
- Tenant Partitioning — All MASI terminals exist in tenant 1, and you cannot change the tenant number.
- Time of Day coverage — As with all coverage, DEFINITY does not control coverage of the MASI terminal.
- Transfer out of AUDIX — A MASI terminal cannot use \*T to transfer from AUDIX to another MASI terminal.

### **Hospitality features**

- Do Not Disturb — MASI terminals cannot activate Do Not Disturb.

### **Multimedia features**

- Multimedia Call Handling — DEFINITY MMCH users are not able to make H.320 calls to MASI terminals over the MASI link. Calls between MMCX terminals and MMCH terminals are voice only.

## Troubleshooting

---

Verify proper operation using the following commands and follow normal escalation procedures to resolve any failures detected by the demand test.

1. Verify the DS1 trunk using the **test board <board location> long** command.
2. Verify the ISDN Signaling Group using the **test signaling-group <group number>** command. Also verify proper administration.
3. Verify the temporary signaling connection using the **test tsc-administered <group number>** command. Also verify proper administration.

### Common error conditions

If the cable from the ECS to the MMCX becomes disconnected, you should see alarms raised against ISDN-SGRP and UDS1-BD. In particular, you should observe ISDN-SGRP errors such as 769, 1793, and 257. To resolve, reconnect the cable and follow normal test procedures.

If the far-end path termination number is incorrect, you should observe MASI-PTH error 513. To resolve, correct administration using the MASI Path Parameters form.

If the Layer 3 TSC is not administered properly or is out of service, you should observe errors (but no alarms) raised against TSC-ADM. Verify the signaling group administration and follow normal escalation procedures for TSC-ADM. *What do these errors look like? Is this meant for anyone other than techs?*

If the TSC fails to come up even through Layer 2 Signaling Group and below pass tests, you may run **test tsc-administered <group number>** to force a switch heartbeat test, or simply wait 5–10 minutes for the link to recover. This situation may happen if the switch is rebooted or if the MASI interface is administered before the MMCX is properly administered.

You may want to use busy port and release port commands to unlock things if features are not working.

## **Multimedia Call Handling**

---

### **Functional description of MMCH**

---

Multimedia Call Handling (MMCH) enables you to control voice, video, and data transmissions using your voice terminal and PC. You can conduct video conferences and route calls like a standard voice call. You can also share PC applications so that you and your colleagues can collaborate while working from remote sites. MMCH enhances your voice terminal's capabilities to place or receive multimedia calls by taking advantage of DEFINITY ECS's powerful call-handling and routing features.

### **Operations in Basic or Enhanced modes**

There are two distinct levels of functionality: Basic and Enhanced. The Basic mode of operation treats a standard-protocol H.320 multimedia call as a data call. If the call is redirected, it is converted to a voice call. As a voice call, certain features are enabled, such as coverage, voice mail, and multiparty video conferencing. The Enhanced mode of operation allows a multifunction voice terminal to control a multimedia call like a standard voice call. Spontaneous video conferencing, call forwarding, call coverage, hold, transfer and park, along with many routing features, are available to multimedia calls. Both modes of operation allow data collaboration between multiple parties using the T.120 standard protocol.

### **Definitions: MMCH features and components**

---

#### **Multimedia call**

A multimedia call, for MMCH, is one that conforms to the H.320 and T.120 suite of protocol standards. These standards allow video-conferencing packages from different vendors to communicate with one another. The capabilities of the individual multimedia-endpoint package can vary, however.

- An H.320 call can contain voice, video and data.
- The bandwidth for MMCH calls is limited to 2 B-channels.

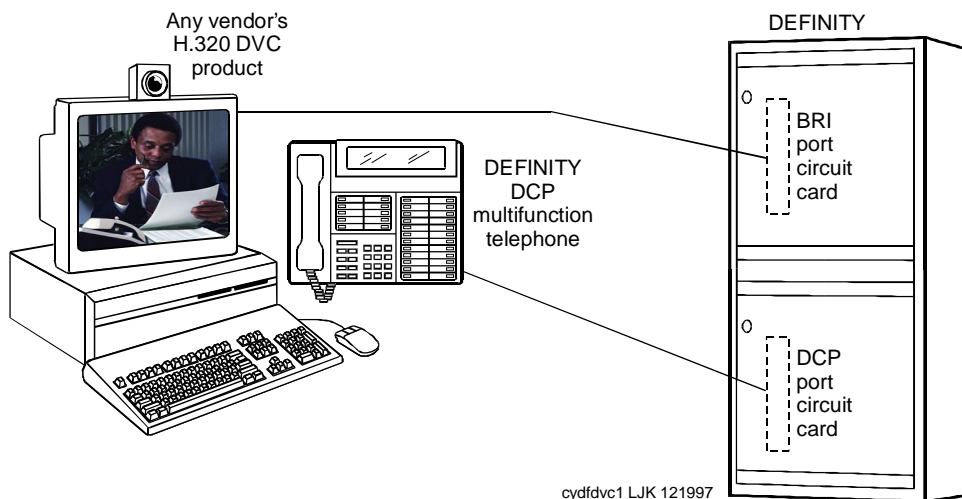

Figure 11-5. MMCH multimedia complex

### Basic multimedia complex

A Basic multimedia complex consists of a BRI-connected multimedia-equipped PC and a non-BRI-connected multifunction voice terminal administered in Basic mode. With a Basic multimedia complex, users place voice calls at the multifunction voice terminal and multimedia calls from the multimedia equipped PC. Voice calls will be answered at the multifunction voice terminal and multimedia calls will alert first at the PC and, if unanswered, will next alert at the voice station. A Basic multimedia complex provides a loose integration of the voice station and H.320 DVC system.

### Enhanced multimedia complex

An Enhanced multimedia complex consists of a BRI-connected multimedia-equipped PC and a non-BRI-connected multifunction voice terminal administered in Enhanced mode. The Enhanced multimedia complex acts as though the PC were directly connected to the multifunction voice terminal. Thus, voice call control, multimedia call control and call status are enabled at the voice terminal. An Enhanced multimedia complex provides a tight integration of the voice station and H.320 DVC system.

### Multimedia endpoint

The multimedia endpoint is a user's PC that has been equipped with an H.320 multimedia package. The PC is physically connected to the DEFINITY ECS with a BRI line.

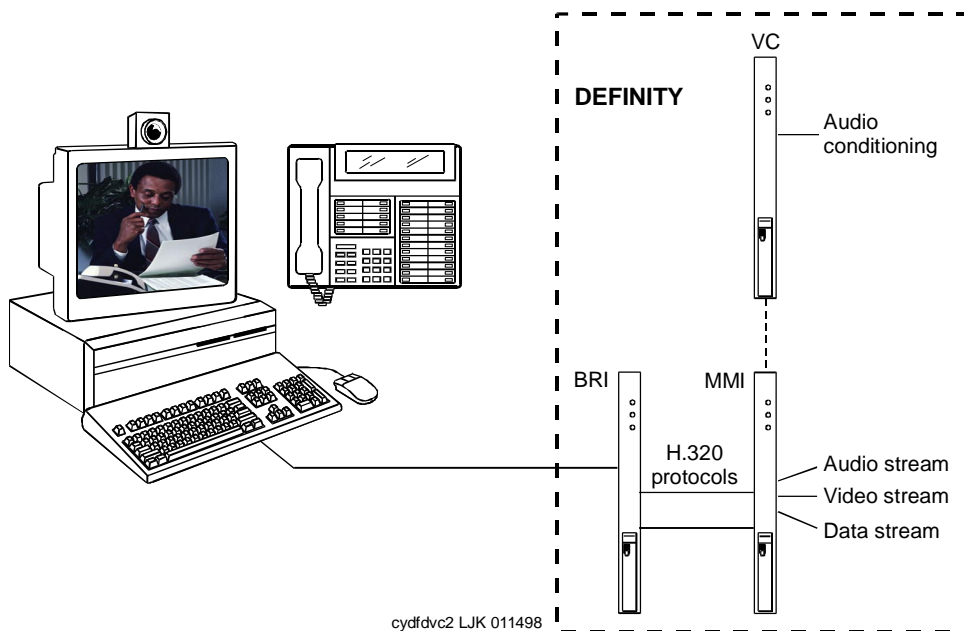

Figure 11-6. Enhanced MMCH service link

### Enhanced mode service link

The service link is the combined hardware and software multimedia connection between the user's multimedia endpoint and the DEFINITY ECS which terminates the H.320 protocol. The service link provides video, data, and, optionally, voice streams to augment the capabilities of the voice terminal and PC. A service link only applies to an Enhanced multimedia complex, never to a Basic multimedia complex. The service link is administered on the station form and can be either "permanent" or "as-needed." For detailed information see [11-49](#).

### Feature Description

MMCH's two levels of functionality for a multimedia complex, Basic and Enhanced mode, are enabled either by switch administration (see "[System Level Administration](#)" on page 11-41) or by an mm-basic feature button or FAC (see [11-51](#)).

### Basic Mode Operation

#### In Basic Mode:

- All voice-only calls originate at the voice station.

## 11 Multimedia

### Multimedia Call Handling

Page 11-33

- All multimedia calls originate with the H.320 DVC system.
- All incoming voice calls attempt to alert at the voice station and receive all standard voice call treatment.
- All incoming H.320 multimedia calls attempt to alert on the H.320 DVC system initially. If answered, a 2-way video call will result. The Basic multimedia complex voice station will not be involved in the call in any way.

If the H.320 multimedia call is not answered at the H.320 DVC system and the Basic multimedia complex voice station has the H.320 field administered to "y", the call will:

- timeout at the DVC system
- alert at the associated voice station set as a voice-only call
- receive all standard voice call treatment.
- Call control depends on what type of call is being originated.
  - Video is received and controlled at the PC.
  - Voice is received and controlled at the telephone set.
- The voice station of a Basic multimedia complex must manually add their multimedia endpoint to a multimedia conference. There is limited support for multimedia feature interactions. A specific set of voice features work for multimedia calls.
- Service Links are not used by Basic mode complexes.
- A single number may be used to reach the Basic multimedia complex for voice or H.320 multimedia calls.

See ["Basic Mode MM complex" on page 11-59.](#)

## Enhanced Mode Operation

The Enhanced multimedia complex provides a much more tightly coupled integration of the complex voice station and H.320 DVC system. In Enhanced Mode:

- Both multimedia and voice calls must originate at the telephone set.
- Voice and multimedia calls can be controlled at the telephone set.
- Conferencing is spontaneous and established just like a voice-only conference call.
- There is extensive support for multimedia feature interaction. Most voice features work the same for multimedia calls.
- Service Links can be either "permanent" or "as-needed."

See ["Enhanced Mode MM complex" on page 11-73.](#)

## Physical Installation

---

The physical components necessary to utilize MMCH capabilities include:

- DEFINITY ECS software (see [“Administration commands” on page 11-41](#)).
- H.320 DVC systems that are BRI connected to the DEFINITY ECS.
- Non-BRI multifunction voice terminals.
- DEFINITY TN787 MultiMedia Interface (MMI) and TN788 Voice Conditioner (VC) boards.
- A T.120 Enhanced Services Module (ESM) server (necessary only if you plan to do T.210 data collaboration). Connectivity of the ESM requires an additional TN787 along with a TN2207 DS1 circuit pack.

## Dual Port Desktop

Both Basic and Enhanced multimedia complexes are dual-port desktops that consist of:

- a BRI-connected multimedia-equipped PC that supports the H.320 protocol
- a non-BRI-connected multifunction telephone set.

The PC and the multifunction voice terminal are individually wired to the DEFINITY ECS. These two pieces of equipment can be administratively associated to form a Basic or ENHANCED multimedia complex (see [“Planning & administration for MMCH” on page 11-37](#)).

MMCH works with any H.320 system that is fully H.320 compliant and operates at the 2B or 128K rate.

### NOTE:

If you intend to share applications among users or whiteboard capabilities, the endpoint software you choose must also support the T.120 protocol.

The following endpoint-software packages have been tested:

- PictureTel PCS 50 & PCS 100, Release 1.6T
- Proshare 2.0a, 2.1
- Zydacron Z250 Ver. 2.02, Z350 Ver. 1.2 (With Netmeeting 2.0)

## MMI & VC hardware

The MMCH feature requires the use of two additional circuit packs:

- Multi Media Interface (MMI) TN787J.
- Voice Conditioner (VC) TN788B.



The TN787 and TN788 are service circuit packs. The TN787 supports simultaneous operation of 16 2B H.320 calls. The TN788 supports the voice processing for 4 H.320 endpoints.

- These service circuit packs may be located in any Port Network.
- These packs do not require any translations as part of their implementation.
- The MMI and VC circuit packs are resource circuit packs akin to the Tone Detector circuit packs.
- These circuit packs require no switch administration and may be located in multiple port networks.
- Specific provisioning guidelines for the number and placement of these packs can be found by calling the Lucent Technical Support Center (TSC) at (303) 850 - 8187.

### **T.120 Data Collaboration Server**

The Expansion Services Module (ESM) provides T.120 data collaboration capability on a MMCH multipoint H.320 video conference.

- Each person in the conference who wants to participate in the data collaboration session, must have a personal computer with an H.320 video application that supports the T.120 protocol.
- The DEFINITY ECS must have an ESM installed.

## ESM Installation

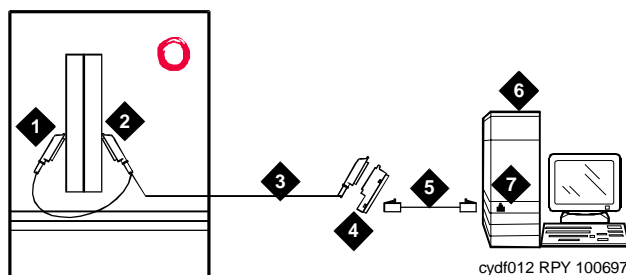

### Figure Notes

1. Port B Y-cable connector to a TN787 multimedia interface (MMI) circuit pack
2. Port A Y-cable connector to a TN2207 PRI circuit pack
3. 25-pair Y-cable
4. 356A adapter
5. D8W cord connected to 356A adapter S/B port 8
6. Expansion service module (ESM)
7. Port B on compatible primary rate interface (PRI) card

### Figure 11-7. Typical Multimedia Call handling ESM Connections

Use the following procedure and [Figure 11-7](#) to connect to the ESM equipment:

1. Install the TN2207 primary rate interface (PRI) circuit pack and the TN787 multimedia interface (MMI) circuit pack in the DEFINITY System port carrier.



#### NOTE:

These two circuit packs should be co-located in the cabinet since they must be connected by a Y-cable on the back plane of the DEFINITY ECS.

2. Record the circuit pack locations.
3. Connect the ESM Y-cable as shown.
4. Administer the DS1 form and the signaling-group form for the ESM (see [“ESM T.120 Server Administration”](#) on page 11-53).
5. Configure the ESM adjunct.

## System Capacities

The following capacity information provides a starting point for understanding the current MMCH physical system limitations.

**Table 11-1. MMCH System Capacities**

|                                    | R6.3 si | R6.3 r |
|------------------------------------|---------|--------|
| TN787 MMI boards                   | 5       | 13     |
| TN788 VC boards                    | 20      | 52     |
| Max Simultaneous 3 MM pty calls    | 26      | 69     |
| Max Simultaneous Conversion calls  | 80      | 208    |
| Nominal Dual-Port Desktops         |         |        |
| ■ Basic mode office environment    | 675     | 2000   |
| ■ Enhanced mode office environment | 225     | 675    |
| ■ Enhanced mode Call Center        | 32      | 83     |

## Planning & administration for MMCH

The following are some of the tasks you perform in planning and administering MMCH.

### Planning the system

This is a list of questions to help you use DEFINITY ECS for multimedia.

- How many MMCH users are you going to have?
- How many multimedia calls do you expect to have at any given time?

With the information above you can determine how many Voice Conditioner (VC) and Multimedia Interface (MMI) circuit packs you need.

- Will users need data collaboration capabilities? If so, you need to install the Expansion Service Module (ESM).
- Which stations, hunt groups or vectors need early answer?
- Do you have ISDN-PRI trunks? It is possible to use separate DS1 trunks for data, but ISDN-PRI trunks are recommended.

## Installation checklist

1. Purchase MMCH right-to-use.
2. Lucent Technologies — enable MMCH on Customer-Options form.
3. Administer default multimedia outgoing trunk parameter selection on the System-Parameters Features form.
4. Administer MMCH related feature access code on the Feature Access Code form.
5. Install and administer hardware:
  - Install MMIs, VCs and ESM.
  - Administer ESM to ECS connection — DS1 Circuit Pack form, Signaling Group form.
  - Establish maintenance parameters — Maintenance Related System Parameters form.
6. Administer multimedia complexes:
  - Administer data modules — Data Module form
  - Administer stations as part of a multimedia complex, assign associated data module extension, multimedia mode, service link mode and appropriate multimedia buttons — Station forms
7. Administer early answer and H.320 flag for stations, the early answer flag for hunt groups, and the multimedia flag for vectors as appropriate.
8. Train end users.
9. Monitor traffic and performance.

## Multimedia Forms

---

**Table 11-2. Required forms**

| Form                                     | Field  | Page                  |
|--|--|-----------------------|
| System-Parameters<br>Customer-Options    | ■ Multimedia Call Handling (Basic)                               | <a href="#">11-41</a> |
|  | ■ Multimedia Call Handling (Enhanced)                            |                       |
| System-Parameters<br>Features            | ■ Default Multimedia Outgoing Trunk<br>Parameter Selection (p.2) | <a href="#">11-42</a> |
| Maintenance-Related<br>System Parameters | ■ Packet Bus Activated = y                                       | <a href="#">11-45</a> |
|  | ■ Minimum Maintenance Thresholds<br>MMIs, VCs                    |                       |
| Data Module<br>(type = 7500 or WCBRI)    | ■ Multimedia (p. 1) = y  | <a href="#">11-46</a> |
|  | ■ XID (p. 2) = n   |                       |
|  | ■ MIM Support (p. 2) = n   |                       |
| Station                                  | ■ MM Complex Data Ext (p. 1)                                     | <a href="#">11-47</a> |
|  | ■ H.320 Conversion (p. 2)  |                       |
|  | ■ Multimedia Early Answer (p. 2)                                 |                       |
|  | ■ Multimedia Mode (p.2)  |                       |
|  | ■ Service Link Mode (p.2)  |                       |
|  | ■ Feature Buttons (p.3) (optional)                               |                       |
| Hunt Group                               | ■ MM Early Answer (optional)                                     | <a href="#">11-56</a> |
| Call Vector                              | ■ Multimedia (optional)  | <a href="#">11-57</a> |

*Continued on next page*

**Table 11-2. Required forms**

|                             |  |                       |
|-----------------------------|--|-----------------------|
| Feature Access Codes        | <ul style="list-style-type: none"> <li>■ Basic Mode Activation (p.5)</li> <li>■ Enhanced Mode Activation (p.5)</li> <li>■ Multimedia Call Access Code (p.5)</li> <li>■ Multimedia Data Conference Activation &amp; Deactivation (p.5)</li> <li>■ Multimedia Multi-Address Access Code (p.5)</li> <li>■ Multimedia Parameter Access Code (p.5)</li> </ul> | <a href="#">11-43</a> |
| DS1 Circuit Pack (ESM Only) | <ul style="list-style-type: none"> <li>■ Bit Rate=2.048</li> <li>■ Line Coding=hdb3</li> <li>■ Signaling Mode=isdn-pri</li> <li>■ Connect=pbx</li> <li>■ Interface=network</li> <li>■ Country Protocol=1</li> <li>■ CRC=y</li> <li>■ MMI Cabling Board</li> </ul>  | <a href="#">11-53</a> |
| Signaling group (ESM Only)  | <ul style="list-style-type: none"> <li>■ Primary D-Channel</li> </ul>  | <a href="#">11-55</a> |

## Administration commands

---

### System Level Administration

#### System-Parameters Customer-Options form:

To enable the MMCH release 6.3 feature, you must change the System-Parameters Customer-Options form. There are two MMCH related fields on page 2 of this form.

- The “Multimedia Call Handling (Basic)” field must be set to ‘y’ to allow MMCH Basic mode operation.
- The “Multimedia Call Handling (Enhanced)” field must be set to ‘y’ to allow MMCH Enhanced mode operations.

```
change system-parameters customer-options                               Page 2 of 4
                                OPTIONAL FEATURES
                                ISDN-BRI Trunks? n Restrict Call Forward Off Net? y
                                ISDN-PRI? y           Secondary Data Module? y
                                ISDN-PRI over PACCON? y           SoftLock? n
                                Malicious Call Trace? n           Station and Trunk MSP? n
                                Mode Code Interface? n           Tenant Partitioning? n
                                Multifrequency Signaling? y       Terminal Trans. Init. (TTI)? n
Multimedia Appl. Server Interface (MASI)? n           Time of Day Routing? n
                                Multimedia Call Handling (Basic)? y           Uniform Dialing Plan? y
                                Multimedia Call Handling (Enhanced)? y       Usage Allocation Enhancements? y
                                Personal Station Access (PSA)? n
                                                Wideband Switching? n
                                                Wireless? n
                                Processor and System MSP? n
                                Private Networking? y

(NOTE: You must logoff & login to effect the permission changes.)
```

Screen 11-15. System-Parameters Customer-Options Form (Page 2 of 4)

### System-Parameters Features form:

The default bandwidth for MMCH calls is defined on the System-Parameters Features form shown below.

 **NOTE:**

Originating a multimedia call with the mm-call button will originate a call according to the Default Multimedia Parameters selected on the System Parameters Features form.

- This default parameter will be either 2x56 or 2x64.
- The bearer capability of the multimedia calls will either be 56K or 64K and the bandwidth will be 2B channels.

```
change system-parameters features                               Page 2 of 8
                    FEATURE-RELATED SYSTEM PARAMETERS
LEAVE WORD CALLING PARAMETERS
Maximum Number of Messages Per Station (when MSA not in service): 10
Stations with System-wide Retrieval Permission (enter extension)
 1:      3:      5:      7:      9:
 2:      4:      6:      8:     10:
WARNING! SEE USER DOCUMENTATION BEFORE CHANGING TTI STATE
          Terminal Translation Initialization (TTI) Enabled? n

          Prohibit Bridging Onto Calls With Data Privacy? n
          Enhanced Abbreviated Dial Length (3 or 4): 3
          Call Forward Override? n
          External Coverage Treatment for Transferred Incoming Calls? n
          Coverage Of Calls Redirected Off-Net Enabled? n
          Default Multimedia Outgoing Trunk Parameter Selection: 2x64
WIRELESS PARAMETERS
Radio Controllers with Download Server Permission (enter board location)
 1:      2:      3:      4:      5:
```

Screen 11-16. System-Parameters Features Form (Page 2 of 8)



## MMCH Feature Access Codes (FACs)

The following MMCH specific feature access codes can be administered in the feature-access-codes form.

### NOTE:

These FACs only work if MMCH has been enabled via the System-Parameters Customer-Options form.

```

change feature-access-codes                                     Page 6 of 6
                                FEATURE ACCESS CODE (FAC)
                                Multimedia Features

                                Basic Mode Activation: *01
                                Enhanced Mode Activation: *02
                                Multimedia Call Access Code: *03
Multimedia Data Conference Activation: *04 Deactivation: #04
                                Multimedia Multi-Address Access Code: *05
                                Multimedia Parameter Access Code: *06
    
```

### Screen 11-17. Feature-Access-Codes Form (Page 6 of 6)

- **Basic Mode Activation:** If you enter this FAC when your system is an Enhanced multimedia complex, it will revert to a Basic multimedia complex. If you enter this FAC when your system is a Basic mode station it will do nothing.
- **Enhanced Mode Activation:** If you enter this FAC when your system is a Basic multimedia complex, it will become an Enhanced multimedia complex. If you enter this FAC when your system is an Enhanced mode station it will do nothing.
- **Multimedia Call Access Code:** If you enter this FAC from any voice station, it indicates to the DEFINITY ECS that you are making an Enhanced multimedia mode call. If you originate a multimedia call with the multimedia call access code, it will originate a call according to the Default Multimedia Parameters selected on the System Parameters Features form.
- **Multimedia Data Conference Activation:** If you enter this FAC from any voice station that is participating in a multimedia call, it will alert the DEFINITY ECS that you want to enable data collaboration with the other parties on the call. If you enter this FAC a second time, it will give denial treatment (since a collaboration session is already active). This FAC only applies to voice stations on a DEFINITY ECS switch equipped with an ESM adjunct.

The Multimedia Data Conference Activation FAC must be entered after your system is active on a multimedia call. To enter the FAC:

1. Select TRANSFER
  2. Receive a dialtone
  3. Dial the Multimedia Data Conference Activation FAC
  4. Receive a confirmation tone
  5. Re-select the call appearance for the held-multimedia call.
- **Multimedia Data Conference Deactivation:** If you enter this FAC from the voice terminal that enabled data collaboration on a multimedia mode call, it will deactivate the data session and revert to a voice and video call. If you enter this deactivation FAC while participating in a data-collaboration multimedia call that *you did not initiate*, you will get denial treatment.

The Multimedia Data Conference Deactivation FAC must be entered after you are active on a multimedia call. To enter the FAC:

1. Select TRANSFER
  2. Receive a dialtone
  3. Dial the FAC
  4. Receive a confirmation tone
  5. Re-select the call appearance for the held multimedia call.
- **Multimedia Multi-Address Access Code:** The multimedia multi-address access code is similar to the multimedia call access code. It allows origination of a multimedia call from a voice station. It is used when the destination being dialed requires a different address for each of the 2 B-channels. For example, ISDN-BRI provided by a Central Office is provisioned with separate listed directory numbers for each B-channel. In order to make a 2B multimedia call to such a device, two sets of addresses must be entered.  
  
Originating a multimedia call with the multimedia multi-address access code will originate a call according to the Default Multimedia Parameters selected on the System Parameters Features form.
  - **Multimedia Parameter Access Code:** This FAC can be entered by any voice station to indicate to the DEFINITY ECS that you want to initiate a multimedia mode call with a specific bearer capability. This FAC would be followed by a 1 or 2 to indicate the following parameter selections respectively: 2x64 (unrestricted initial system default), 2x56 (restricted).

## Maintenance-Related System Parameters

```

- -
change system-parameters maintenance                               Page 2 of 3
                MAINTENANCE-RELATED SYSTEM PARAMETERS

MINIMUM MAINTENANCE THRESHOLDS ( Before Notification )
    TRs: 4          CPTRs: 1          Call Classifier Ports: 0
    MMIs: 0         VCs: 0

TERMINATING TRUNK TRANSMISSION TEST ( Extension )
    Test Type 100:          Test Type 102:          Test Type 105:

ISDN MAINTENANCE
    ISDN-PRI Test Call Extension:          ISDN-BRI Service SPID:

DS1 MAINTENANCE
    DS0 Loop-Around Test Call Extension:

LOSS PLAN ( Leave Blank if no Extra Loss is Required )
    Minimum Number of Parties in a Conference Before Adding Extra Loss:

SPE OPTIONAL BOARDS
    Disk? y          Packet Intf1? y          Packet Intf2? n          Packet Intf3? n
  
```

Screen 11-18. Maintenance-Related System Parameters Form (Page 2 of 3)

## Multimedia Complex/Station

Use the following administration commands to add, change, duplicate, or remove stations and data modules.

| Action    | Objects                | Qualifier  |
|-----------|------------------------|--|
| add       | station<br>data module | xxxxx (extension) or 'next'<br>xxxxx (extension) or 'next' |
| change    | station<br>data module | xxxxx (extension)<br>xxxxx (extension)                     |
| duplicate | station<br>data module | xxxxx (extension)<br>xxxxx (extension)                     |
| remove    | station<br>data module | xxxxx (extension)<br>xxxxx (extension)                     |

### Data module form

The H.320 DVC system should contain a BRI interface. You must connect this BRI interface to a port on a TN556 BRI circuit pack and administer it as a BRI data module.

- You may administer the data endpoint type as 7500 (recommended) or WCBRI.
- The fields for multimedia are the same on either form.
- The administration for a Basic mode and an Enhanced mode data module are exactly the same.

```

                                                                 Page 1 of 2
                                DATA MODULE
Data Extension: 65001      Name: _____
      Type: 7500_____ COS: 1_      Multimedia? y
      Port: _____   COR: 1_      MM Complex Voice Ext: 67434

ABBREVIATED DIALING
List1: _____
SPECIAL DIALING OPTION: hot-line
HOT LINE DESTINATION
Abbreviated Dialing Dial Code (From above list): _
CIRCUIT SWITCHED DATA ATTRIBUTES (used for modem pooling)
Default Duplex: full      Default Mode: async      Default Speed: 1200_
DATA MODULE CAPABILITIES
Default ITC: restricted          Default Data Application? M2_A
    
```

Screen 11-19. Data Module Form (Page 1 of 2)

```

                                                                 Page 2 of 2
                                DATA MODULE
BRI LINK/MAINTENANCE PARAMETERS
      XID? n      Fixed TEI? n      TEI: ____
      MIM Support? n
    
```

Screen 11-20. Data Module Form (Page 2 of 2)

- **Type** — Set the data module type to 7500 or WCBRI.
- **Multimedia** — This field appears on the data module form only if MM is set to yes on the System-Parameters Customer Options form. Enter Y to enable this data module to be multimedia compliant.

- **MM Complex Voice Ext:** (display only) — This field contains the number of the associated telephone in the complex. This is a display-only field, and is blank until you enter the data module extension in the Station form MM Complex Data Ext field. Once you have done that, these two extensions are associated as two parts of a multimedia complex.
- **XID and MIM Support** — These fields must be set to n.

### Station form

After you have administered the BRI data module, use the Station form to associate it with a voice station to form a multimedia complex. This is a one-to-one relationship: you can administer only one station and one data endpoint per multimedia complex. Neither the voice station, nor the data endpoint can be a member of another multimedia complex.

 **NOTE:**

A BRI station cannot be part of a multimedia complex.

### Station form, page 1

```

change station 67434                                     Page 1 of 5
                                                    STATION
Extension: 67434                                         Lock Messages? n      BCC: 0
  Type: 7434D                                           Security Code:        TN: 1
  Port: 01C1103                                         Coverage Path 1:     COR: 1
  Name: jud's phone                                     Coverage Path 2:     COS: 1
                                                    Hunt-to Station:
STATION OPTIONS
  Data Module? n                                       Personalized Ringing Pattern: 1
  Display Module? y                                   Message Lamp Ext: 67434
  Display Language: english
                                                    Coverage Module? n
                                                    MM Complex Data Ext: 65001
    
```

### Screen 11-21. Station Form (Page 1 of 5)

- **MM Complex Data Ext:** — This is the extension assigned to the data module of the multimedia complex. This field must be filled out to create either a Basic or an Enhanced multimedia complex. Other users can dial this extension to place either a voice or a multimedia call to this complex. It is interchangeable with the voice station extension for reaching the multimedia complex directly.

Station form, page 2

```

change station 67434                                     Page 2 of 5
                                                    STATION
FEATURE OPTIONS
    LWC Reception: msa-spe           Auto Select Any Idle Appearance? n
    LWC Activation? y                Coverage Msg Retrieval? y
    CDR Privacy? n                   Auto Answer: none
    Redirect Notification? y         Data Restriction? n
    Per Button Ring Control? n      Idle Appearance Preference? n
    Bridged Call Alerting? n
    Active Station Ringing: single   Restrict Last Appearance? y

    H.320 Conversion? y
    Service Link Mode: as-needed Per Station CPN - Send Calling Number?
    Multimedia Mode: enhanced       Multimedia Early Answer? n

                                     Display Client Redirection? n
                                     Select Last Used Appearance? n
    
```

Screen 11-22. Station Form (Page 2 of 5)

- H.320 Conversion** — This field is optional for non-multimedia complex voice stations and for Basic multimedia complex voice stations. It is mandatory for Enhanced multimedia complex voice stations. Because the system can only handle a limited number of conversion calls, you may need to limit the number of telephones with H.320 conversion. Enhanced multimedia complexes must have this flag set to **y**.

For non-multimedia complex voice stations, setting this field to **y** allows H.320 calls to convert to voice and alert at the standalone voice station. If the call is unanswered at the voice station, the call will follow standard voice treatment. Any subsequent station that is reached in the routing of this call, that is, coverage points, forwarded destinations, call pickup members, and so forth, do not need to have the H.320 field enabled. The H.320 field is only needed at the *first* station that may receive the H.320 call.

For Basic multimedia complex voice stations, setting this field to **y** allows H.320 calls to convert to voice and alert at the Basic multimedia complex voice station *after* an attempt has been made to offer the call to the H.320 DVC system. If the call is unanswered at the H.320 DVC system, the call will alert at the voice station after 5 seconds or after the administered number of rings as specified in the voice station's coverage path. If the call is unanswered at the voice station, the call will follow standard voice treatment. Any subsequent station that is reached in the routing of this call, that is, coverage points, forwarded destinations, call pickup members, and so forth, do not need to have the H.320 field enabled. The H.320 field is only needed at the *first* station that may receive the H.320 call.

- **Service Link Mode** — The service link is the combined hardware and software multimedia connection between an Enhanced mode complex's H.320 DVC system and the DEFINITY ECS which terminates the H.320 protocol. A service link is never used by a Basic mode complex H.320 DVC system. Connecting a service link will take several seconds. When the service link is connected, it uses MMI, VC and system timeslot resources. When the service link is disconnected it does not tie up any resources. The Service Link Mode can be administered as either 'as-needed' or 'permanent' as described below:
  - As-Needed - Most non-call center multimedia users will be administered with this service link mode. The as-needed mode provides the Enhanced multimedia complex with a connected service link whenever a multimedia call is answered by the station and for a period of 10 seconds after the last multimedia call on the station has been disconnected. Having the service link stay connected for 10 seconds allows a user to disconnect a multimedia call and then make another multimedia call without having to wait for the service link to disconnect and re-establish.
  - Permanent - Multimedia call center agents and other users who are constantly making or receiving multimedia calls may want to be administered with this service link mode. The permanent mode service link will be connected during the station's first multimedia call and will remain in a connected state until the user disconnects from their PC's multimedia application or the DEFINITY ECS switch restarts. This provides a multimedia user with a much quicker video cut-through when answering a multimedia call from another permanent mode station or a multimedia call that has been early answered.
- **Multimedia Mode** — There are two multimedia modes, Basic and Enhanced, as described below:
  - Basic — A Basic multimedia complex consists of a BRI-connected multimedia-equipped PC and a non-BRI-connected multifunction telephone set. When in Basic mode, users place voice calls at the multifunction telephone and multimedia calls from the multimedia equipped PC. Voice calls will be answered at the multifunction telephone and multimedia calls will alert first at the PC and if unanswered will next alert at the voice station if it is administered with H.320 = y. A Basic mode complex has limited multimedia feature capability as described in ["Basic Mode Operation" on page 11-32](#).
  - Enhanced — An Enhanced multimedia complex consists of a BRI-connected multimedia-equipped PC and a non-BRI-connected multifunction telephone. The Enhanced mode station acts as though the PC were directly connected to the multifunction telephone; the service link provides the actual connection between DEFINITY ECS and the PC. Thus, voice and multimedia calls are originated and received at the telephone set. Voice and multimedia

call status are also displayed at the telephone set. An Enhanced mode station allows multimedia calls to take full advantage of most call control features as described in [“Enhanced Mode Operation” on page 11-33](#).

- **Multimedia Early Answer** — This field lets you set this phone for early answer of multimedia calls. The system will answer the incoming multimedia call on behalf of the station and proceed to establish the H.320 protocol. After audio path has been established to the caller, the call will then alert at the voice station. The station may then answer by going off-hook and will have immediate audio path. No hourglass tone will be heard by the answering party (see [“Hourglass Tone” on page 11-64](#)).

Example: An administrative assistant who does not have a multimedia PC, but may get multimedia mode calls from forwarding or coverage, may want to set the H.320 flag to **y** and the early answer flag to **y** on their voice station. This allows any multimedia call to be presented to the station with immediate voice path rather than hourglass tone. The answered call could then be transferred as voice to voice mail or transferred as multimedia to a user equipped with a multimedia endpoint.

## Multimedia Buttons

There are six new multimedia specific buttons that may be added to a voice station. Most of them may be placed on any voice station, whether it is part of a Basic multimedia complex, an Enhanced multimedia complex or not part of any multimedia complex. Two feature buttons, mm-basic and mm-pcaudio, may only be placed on stations which are part of an Enhanced multimedia complex.

All of the multimedia specific feature buttons have a corresponding feature access code except mm-pcaudio and mm-cfwd.

- The mm-pcaudio feature can only be used with a station form button.
- The mm-cfwd button may be replaced by the standard “*call forward*” FAC followed by the “*multimedia call*” FAC.



### Station form, page 3

```

change station 67434                                     Page 3 of 5

                                STATION

SITE DATA
  Room:                                     Headset? n
  Jack:                                     Speaker? n
  Cable:                                    Mounting: d
  Floor:                                    Cord Length: 0
  Building:                                 Set Color:

ABBREVIATED DIALING
  List1:                                     List2:                                     List3:

BUTTON ASSIGNMENTS
  1: call-appr                               6: mm-pcaudio
  2: call-appr                               7: mm-datacnf
  3: call-appr                               8: mm-cfwd
  4: mm-call                                 9: mm-multnbr
  5: mm-basic                               10:
  
```

Screen 11-23. Station Form (Page 3 of 5)

- **mm-call** — This button may exist on any voice station. Most multimedia enabled users will want an mm-call button. This button (or it's corresponding FAC) must be used to indicate that the user is placing a multimedia mode call. To place a multimedia mode call the user would go off-hook, select an idle call appearance, and press the mm-call button followed by the destination extension digits. If the user has a speakerphone they can simply press the mm-call button, which preselects an idle call appearance, followed by the destination extension digits.

The mm-call button lamp lights when you press this button during call origination. The lamp also lights to indicate that the selected call appearance is a multimedia mode call.

- **mm-basic** — This button is only allowed on the voice station of a multimedia complex. The mm-basic button toggles your station between Basic and Enhanced modes. If you press the mm-basic button when you are an Enhanced multimedia complex, you will revert to a Basic multimedia complex and the button status lamp will be lit. If you press this button when you are a Basic mode station it will switch you to an Enhanced mode station and the button status lamp will not be lit. This button can NOT be used to change the station's multimedia mode when the station has an active multimedia call appearance.

Toggleing between Basic and Enhanced mode changes the station's administered Multimedia mode. When in Basic mode this field on the station form will show *basic*. When in Enhanced mode this field on the station form will show *enhanced*. The current station Multimedia mode will be saved to translation when a **save translation** command is executed.

- **mm-pcaudio** — This button only works for an Enhanced multimedia complex voice station. When originating or receiving a multimedia call, the audio path is connected to the voice station's handset or speakerphone device. The mm-pcaudio button allows a user to switch the audio portion of any call to their PC's audio input/output device (if available). To switch the audio path to the PC while active on a call, the user presses the mm-pcaudio button (if off-hook you may now hang up the handset). The mm-pcaudio button's status lamp will light up when the button is pushed to move the audio path to the PC and remain lit while the audio path is at the PC device.



**NOTE:**

If you are on a voice only call, the voice path will switch to the PC device but you will get muted or loopback video depending on the multimedia endpoint software.

A user may simply go off-hook on their voice station or press the speakerphone button to move the audio path of a multimedia call from the PC back to the voice station. Pressing the mm-pcaudio button while the status lamp is lit and the voice station's handset is on-hook will disconnect the user from the active call.

- **mm-datacnf** — Pressing the mm-datacnf button from any voice station that is participating in a multimedia call will light the status lamp and alert the DEFINITY ECS that you want to enable T.120 data collaboration with the other parties on the call. The button status lamp will also light for other participants in the multimedia call who have mm-datacnf buttons.

Pressing this button from the voice station that enabled data collaboration on a multimedia mode call will deactivate the data session and revert to a voice and video call. If you are participating on a multimedia call with data collaboration, but did not initiate the data collaboration, and you press this button, the status lamp led will flash momentarily and the T.120 data services will not be terminated, (only the station that activated the collaboration session can deactivate it). This button only works for stations connected to a DEFINITY ECS equipped with an ESM adjunct.

- **mm-cfwd** — The mm-cfwd button allows a user to indicate that multimedia mode calls will be forwarded off of the DEFINITY ECS switch as multimedia mode calls to a specific forwarded-to destination. If voice call forwarding is active and multimedia call forwarding is not active then multimedia calls going off of the DEFINITY ECS switch will be forwarded as voice only calls.

The mm-cfwd button status lamp will be lit to indicate that multimedia call forwarding is activated. Pressing the mm-cfwd button when the lamp is lit will deactivate multimedia call forwarding.

Note - pressing the mm-cfwd button is the same as dialing the regular call-fwd FAC followed by the mm-call button or FAC followed by the desired forwarded-to extension digits.

- **mm-multinbr** — The mm-multinbr call button is similar to the mm-call button. It allows origination of a multimedia call from any voice station. It is used when the destination being dialed requires a different address for each of the 2 B-channels. An example of this is Central Office provided ISDN-BRI. This type of BRI line is provisioned with separate listed directory numbers for each B-channel. In order to make a 2B multimedia call to such a device, two sets of address must be entered.

Originating a multimedia call with the mm-multinbr button will originate a call according to the Default Multimedia Parameters selected on the System Parameters Features form. This default parameter will be either 2x56 or 2x64. The bearer capability of the multimedia calls will either be 56K or 64K and the bandwidth will be 2B channels.

## ESM T.120 Server Administration

### DS1 form, page 1

```

change ds1 1c09                                     Page 1 of 1
                                                    DS1 CIRCUIT PACK

      Location: 01C09                               Name:
      Bit Rate: 2.048                               Line Coding: hdb3

      Signaling Mode: isdn-pri                       Interface: network
      Connect: pbx                                   Country Protocol: 1

                                                    CRC? y

      Idle Code: 11111111                           DCP/Analog Bearer Capability: 3.1kHz
      MMI Cabling Board: 01C10                       MMI Interface: ESM

      Slip Detection? n                               Near-end CSU Type: other
    
```

Screen 11-24. DS1 Form (Page 1 of 1)

From the system administration terminal:

1. Enter **list configuration all**, and a list of the installed carriers, circuit packs, and ports appears.
2. Record the location (board number) of the MMI board cabled to the Tn2207 slot and verify that all other required circuit packs (refer to [“ESM Installation”](#)) are present.
3. Enter **add DS1 xxxxx**, (where xxxxx is the location of the TN2207 PRI circuit pack recorded in step 2), and the DS1 circuit pack administration form appears.
4. Set the Name: field to **ESM DS1**
5. Set the Bit Rate: field to **2.048**  
  
The TN2207 DS1 must have a bit rate of 2.048, even if all other DS1 boards in the system are operating at 1.544. Verify the 24/32 channel switch on the circuit pack is in the 32 channel position.
6. Set the Line Coding: field to **hdb3**
7. Set the Signaling Mode: field to **isdn-pri**
8. Set the Connect: field to **pbx**
9. Set the Interface: field to **network**
10. Set the Country Protocol: field to **1**
11. Set the CRC?: field to **y**
12. The Idle Code default is 11111111.
13. The DCP/Analog Bearer Capability default is 3.1 kHz.
14. Set the MMI Cabling Board: field to **xxxxx** (where xxxxx is the location of the TN787 MMI circuit pack recorded in step 2). This must be the slot for port B of the Y-cable.
15. The MMI Interface: field **ESM** appears.

## Signaling-Group form, page 1

```
change signaling-group 6                               Page 1 of 5
                                     SIGNALING GROUP

Group Number: 6
Associated Signaling? y                               Max number of NCA TSC: 0
Primary D-Channel: 01C0916                           Max number of CA TSC: 0
Trunk Group for Channel Selection:                    Trunk Group for NCA TSC:
Supplementary Service Protocol: a
```

### Screen 11-25. Signaling-Group Form (Page 1 of 5)

1. Enter **add signaling-group next** and the signaling-group form appears.
2. Change Associated Signaling: field to **y**.
3. Change Primary D-Channel Port: field to **xxxx16** (where xxx is the address of the TN2207 PRI circuit pack, for example: 1B0516).
4. The Max Number of NCA TSC: default is 0.
5. The Max Number of GA TSC: default is 0.
6. Trunk Group for NCA TSC: \_\_\_\_ (leave blank)
7. Trunk Group for Channel Selection: \_\_\_\_ (leave blank)
8. Logoff the terminal and then log back on the terminal to view your changes.

**Troubleshooting.** To determine ESM link status enter the following commands from the system administration terminal:

1. **Status esm**
2. **Status signaling-group**
3. **List MMI**

#### NOTE:

When you move ESM circuit packs, you **MUST** remove the DS1 and signaling group translations. You cannot use the **change circuit pack** command.

## Hunt Group Form

(See [11-69](#) for Hunting with Basic Complex or [11-71](#) for Hunting with Enhanced Mode Complex.)

```
change hunt-group 101                                     Page 1 of 3
                                                         HUNT GROUP
Group Number: 101                                       ACD? y
Group Name: hu 101                                       Queue? y
Group Extension: 52001                                   Vector? y
Group Type: ucd-mia
TN: 1
COR: 1                                                   MM Early Answer? n
Security Code:
ISDN Caller Display:

Queue Length: 5
Calls Warning Threshold: 2   Port:
Time Warning Threshold: 15  Port:
```

### Screen 11-26. Hunt Group Form (Page 1)

- **MM Early Answer** — This field is to be used when the hunt group will expect to receive H.320 multimedia calls and the members of the hunt group are voice extensions. The voice members of the hunt group should all have the H.320 field on each of their station forms set to “y”. The MM Early Answer field lets you set this hunt group for early answer of multimedia calls. The system will answer the incoming multimedia call on behalf of the agent and proceed to establish the H.320 protocol. After audio path has been established, the call will then alert at the agent’s voice station. The station may then answer by going off-hook and will have immediate audio path. No hourglass tone will be heard by the answering party. This is especially important for AUDIX hunt groups, because otherwise the caller may miss all or a portion of the AUDIX greeting.

The MM Early Answer field has no effect on voice calls.

The MM Early Answer field has no effect if the hunt group members are data extensions.

## Call Vector Form

```

change vector 10                                     Page 1 of 3
                                                    CALL VECTOR

Number: 10                                         Name                               Multimedia? y   Lock? n
  Basic? y   EAS? n   G3V4 Enhanced? y   ANI/II-Digits? y   ASAI Routing? n
  Prompting? n   LAI? n   G3V4 Adv Route? y           CINFO? n           BSR? n

01 route-to      number 69999                with cov n if unconditionally
02
03
04
05
06
07
08
09
10
  
```

### Screen 11-27. Call Vector Form (Page 1 of 3)

**Multimedia** — Very often, calls are routed to hunt groups or skills via a vector. The existing VDNs and vectors which exist for routing voice calls can be used to route multimedia calls.

In order to use a vector for multimedia calls that will terminate to voice stations, you must set the Multimedia field on the vector form to **y**. This field has no effect on voice calls routing through the vector. This field will cause multimedia calls routed through the vector to receive early answer treatment prior to processing the vector steps. This provides a talk path to the caller for announcements or immediate conversation with an agent.



**NOTE:**

Vectors which have the Multimedia field set to “y” must eventually route to hunt groups, skills or numbers which are voice extensions. A vector with the multimedia field set to “y” should never be set up to route to a hunt group or number which is a data extension.

When a vector is used to route video (56K/64K) calls to a hunt group comprised of data extensions, the vector *must* have the multimedia field set to **n**.

## Duplicating multimedia endpoints

Use the **duplicate station** command to enter groups of multimedia endpoints at one time. If the original station form had a data module page, the second page of this form appears.

| STATION |       |       |               |       |       |       |          |
|---------|-------|-------|---------------|-------|-------|-------|----------|
| Ext     | Port  | Name  | Security Code | Room  | Jack  | Cable | Endpt ID |
| _____   | _____ | _____ | _____         | _____ | _____ | _____ | _____    |
| _____   | _____ | _____ | _____         | _____ | _____ | _____ | _____    |
| _____   | _____ | _____ | _____         | _____ | _____ | _____ | _____    |
| _____   | _____ | _____ | _____         | _____ | _____ | _____ | _____    |
| _____   | _____ | _____ | _____         | _____ | _____ | _____ | _____    |
| _____   | _____ | _____ | _____         | _____ | _____ | _____ | _____    |
| _____   | _____ | _____ | _____         | _____ | _____ | _____ | _____    |
| _____   | _____ | _____ | _____         | _____ | _____ | _____ | _____    |
| _____   | _____ | _____ | _____         | _____ | _____ | _____ | _____    |
| _____   | _____ | _____ | _____         | _____ | _____ | _____ | _____    |
| _____   | _____ | _____ | _____         | _____ | _____ | _____ | _____    |
| _____   | _____ | _____ | _____         | _____ | _____ | _____ | _____    |
| _____   | _____ | _____ | _____         | _____ | _____ | _____ | _____    |
| _____   | _____ | _____ | _____         | _____ | _____ | _____ | _____    |
| _____   | _____ | _____ | _____         | _____ | _____ | _____ | _____    |
| _____   | _____ | _____ | _____         | _____ | _____ | _____ | _____    |
| _____   | _____ | _____ | _____         | _____ | _____ | _____ | _____    |
| _____   | _____ | _____ | _____         | _____ | _____ | _____ | _____    |
| _____   | _____ | _____ | _____         | _____ | _____ | _____ | _____    |
| _____   | _____ | _____ | _____         | _____ | _____ | _____ | _____    |

Screen 11-28. Duplicate Station Form (Page 1)

| STATION |          |               |             |
|---------|----------|---------------|-------------|
| Ext     | Data Ext | Data Ext Name | MM Data Ext |
| xxxxxx  | _____    | _____         | _____       |
| xxxxxx  | _____    | _____         | _____       |
| xxxxxx  | _____    | _____         | _____       |
| xxxxxx  | _____    | _____         | _____       |
| xxxxxx  | _____    | _____         | _____       |
| xxxxxx  | _____    | _____         | _____       |
| xxxxxx  | _____    | _____         | _____       |
| xxxxxx  | _____    | _____         | _____       |
| xxxxxx  | _____    | _____         | _____       |
| xxxxxx  | _____    | _____         | _____       |
| xxxxxx  | _____    | _____         | _____       |
| xxxxxx  | _____    | _____         | _____       |
| xxxxxx  | _____    | _____         | _____       |
| xxxxxx  | _____    | _____         | _____       |
| xxxxxx  | _____    | _____         | _____       |
| xxxxxx  | _____    | _____         | _____       |
| xxxxxx  | _____    | _____         | _____       |
| xxxxxx  | _____    | _____         | _____       |
| xxxxxx  | _____    | _____         | _____       |
| xxxxxx  | _____    | _____         | _____       |
| xxxxxx  | _____    | _____         | _____       |
| xxxxxx  | _____    | _____         | _____       |

Screen 11-29. Duplicate Station Form (Page 2)

Detailed feature operation descriptions follow.



## Basic Mode MM complex

---

**1-number access.** 1-number access permits originating users to make voice or multimedia calls to a Basic multimedia complex by dialing the same number for either type of call. The number may be the voice station extension or the data module extension. If the incoming call is a voice call, DEFINITY ECS directs it to the telephone. If the incoming call is 56K or 64K data call, DEFINITY ECS recognizes it as such and sends it to the multimedia endpoint. Likewise, if a voice call is addressed to the data extension, the system recognizes this and directs the call to the voice station.

Calls originating on the same switch as the Basic mode complex destination may always use 1-number access for voice or video. In order to take advantage of 1-number access for calls originating from a remote location, the incoming calls must arrive over ISDN-PRI trunks. If the system is setup with separate data non-PRI digital facilities multimedia calls must be made to the data extension.

AVD (Alternate voice/data) trunk groups cannot be used to provide 1-number access with MMCH. If the AVD trunk group has a BCC of 0, all calls arriving over the AVD trunk to the Basic mode complex will be assumed to be voice calls. If the AVD trunk group has a BCC of 1 or 4, all calls arriving over the AVD trunk to the Basic mode complex will be assumed to be multimedia calls.

**Originating voice calls.** All voice calls are originated at the voice station.

**Originating multimedia calls.** For a Basic mode complex, multimedia calls are normally originated at the user's multimedia equipped PC. These multimedia calls use the associated station's COR/COS.

The voice station of a Basic multimedia complex may also use the "mm-call" button or FAC, and the "mm-multinbr" button or FAC to originate multimedia calls. When these methods are used, a multimedia call is originated from the voice station. In order for the Basic multimedia complex to receive video, the user must make a call from the H.320 DVC system to the voice station of the complex or must make a multimedia call from the voice station to the H.320 DVC. This allows the station to spontaneously add themselves or other parties to a multimedia conference.

1. **H.320 DVC system GUI.** The normal way for a Basic multimedia complex endpoint to originate a multimedia call is through the vendor provided user interface. Generally, digits to dial are entered, speed is selected and the call originates from the DVC system. The voice station is not involved in such as origination.

Any voice station may use the following mechanisms to originate a multimedia call from the voice station. For stations that are not part of a multimedia complex, video cannot be provided. For voice stations that are part of a Basic multimedia complex, video is not provided until a multimedia call is made from the complex's H.320 DVC system to the

## 11 Multimedia

### Basic Mode MM complex

Page 11-60

voice station or a multimedia call is made from the voice station to the H.320 DVC system. Video is automatically included for Enhanced multimedia complexes (see [11-33](#)).

2. **mm-call (Multimedia Call) button.** If the station has an mm-call button administered, the user goes off-hook and selects the mm-call button. The user may select the mm-call button and then go off-hook. If the user has a speakerphone on the station, the user may originate the call simply by selecting the mm-call button. The speakerphone will automatically be placed off-hook and dialtone will be heard. Upon selection of the mm-call button, the mm-call status lamp (green led) should become solid.

The user now dials the destination address digits. The destination address may be provided by dialing digits, using abbreviated dial entries, last number dialed, station busy indicators, etc. Originating a multimedia call with the mm-call button will originate a call according to the Default Multimedia Parameters selected on the System Parameters Features form. This default parameter will be either 2x56 or 2x64. The bearer capability of the multimedia calls will either be 56K or 64K and the bandwidth will be 2B channels.

For calls with a bandwidth of 2B, use of the mm-call button to originate will cause the same destination address to be used for both channels of the 2B call. See the section below on the mm-multinbr button/FAC for information on originating a 2B call where the destination has a different address for each B-channel.



#### NOTE:

The mm-call feature button is generally used by stations that are part of an Enhanced multimedia complex, but may be used by any station to originate a multimedia call.

3. **Multimedia Call feature Access Code.** For stations that do not have an administered mm-call button, the Multimedia call feature access code may be used instead. The user goes off-hook on the station, waits for dialtone, then dials the MM-call FAC, receives dialtone again and then dials the call normally. The destination address may be provided by dialing digits, using abbreviated dial entries, last number dialed, station busy indicators, etc.

Originating a multimedia call with the mm-call button will originate a call according to the Default Multimedia Parameters selected on the System Parameters Features form. This default parameter will be either 2x56 or 2x64. The bearer capability of the multimedia calls will either be 56K or 64K and the bandwidth will be 2B channels.

For calls with a bandwidth of 2B, use of the mm-call button to originate will cause the same destination address to be used for both channels of the 2B call. See the section below on the mm-multinbr button/FAC for information on originating a 2B call where the destination has a different address for each B-channel.

 **NOTE:**

The mm-call feature access code is generally used by stations that are part of an Enhanced multimedia complex, but may be used by any station to originate a multimedia call.

4. **mm-multinbr (Multimedia Multi-number) button.** The mm-multinbr button is similar to the mm-call button. It allows origination of a multimedia call from a voice station. It is used when the destination being dialed requires a different address for each of the 2 B-channels. An example of this is Central Office provided ISDN-BRI. This type of BRI line is provisioned with separate listed directory numbers for each B-channel. In order to make a 2B multimedia call to such a device, two sets of addresses must be entered.

The user goes off-hook and selects the mm-multinbr button. The user may select the mm-multinbr button and then go off-hook. If the user has a speakerphone on the station, the user may originate the call simply by selecting the mm-multinbr button. The speakerphone will automatically be placed off-hook and dialtone will be heard. Upon selection of the mm-multinbr button, the mm-multinbr and mm-call (if present) status lamp (green led) should light steadily. The user now dials the first destination address digits. The destination address may be provided by dialing digits, using abbreviated dial entries, last number dialed, etc. The system will provide dialtone after the first address has been completed. The user now dials the second destination address digits. The destination address may be provided by dialing digits, using abbreviated dial entries, last number dialed, etc. After the 2nd address has been collected the mm-multinbr status lamp will go off.

Originating a multimedia call with the mm-multinbr button will originate a call according to the Default Multimedia Parameters selected on the System Parameters Features form. This default parameter will be either 2x56 or 2x64. The bearer capability of the multimedia calls will either be 56K or 64K and the bandwidth will be 2B channels.

 **NOTE:**

The mm-multinbr feature button is generally used by stations that are part of an Enhanced multimedia complex, but may be used by any station to originate a dual address multimedia call.

5. **Multimedia Multi-number Call feature Access Code.** For stations that do not have an administered mm-multinbr button, the Multimedia Multi-number call feature access code may be used instead. It allows origination of a multimedia call from a voice station. It is used when the destination being dialed requires a different address for each of the 2 B-channels. An example of this is Central Office provided ISDN-BRI. This type of BRI line is provisioned with separate listed directory numbers for each B-channel. In order to make a 2B multimedia call to such a device, two sets of addresses must be entered.

## 11 Multimedia

### Basic Mode MM complex

Page 11-62

The user goes off-hook and dials the MM-multinbr feature access code. Upon dialing of the MM-multinbr FAC, the mm-call (if present) status lamp (green led) should become solid. The user now dials the first destination address digits. The destination address may be provided by dialing digits, using abbreviated dial entries, last number dialed, etc. The system will provide dialtone after the first address has been completed. The user now dials the second destination address digits. The destination address may be provided by dialing digits, using abbreviated dial entries, last number dialed, etc.

Originating a multimedia call with the MM-multinbr FAC will originate a call according to the Default Multimedia Parameters selected on the System Parameters Features form. This default parameter will be either 2x56 or 2x64. The bearer capability of the multimedia calls will either be 56K or 64K and the bandwidth will be 2B channels.

#### NOTE:

The mm-multinbr FAC is generally used by stations that are part of an Enhanced multimedia complex, but may be used by any station to originate a dual address multimedia call.

6. **Multimedia parameter selection feature access code.** This FAC is used to originate a multimedia call that wishes to use a different bearer and bandwidth than the system default. For example, if the system has a default multimedia parameter of 2x64 and the user wishes to make a call to a destination that is known to only have 56K digital facilities, the MM parameter selection FAC can be used to select a bearer and bandwidth of 2x56 for this specific call.

The MM parameter selection FAC may be used in conjunction with the mm-multinbr button or FAC to make a single or dual address multimedia call at the desired bearer and bandwidth. The user goes off-hook and dials the MM-parameter selection feature access code. Dialtone is returned. The user enters a single digit, 1 or 2, where 1 = 2x64, 2 = 2x56. All other digits will produce reorder. Dialtone is returned. Upon dialing of the MM-parameter selection FAC, the mm-call (if present) status lamp (green led) should become solid. The user may indicate a dual-address call at this point with the mm-multinbr button or FAC. The user now dials one or two sets of destination address digits. The destination address may be provided by dialing digits, using abbreviated dial entries, last number dialed, etc.

#### NOTE:

The mm-parameter selection FAC is generally used by stations that are part of an Enhanced multimedia complex, but may be used by any station to originate a dual address multimedia call.

7. Dialing sequences that include TACs, AAR, ARS, Authorization codes, CDR account codes, FRLs
  1. Single address with TAC

11 Multimedia

Basic Mode MM complex

- **Dial** mm-call button or FAC, **Hear** dialtone
- **Dial** TAC, **Dial** destination digits
- 2. Dual address with TAC
  - **Dial** mm-multinbr button or FAC, **Hear** dialtone
  - **Dial** TAC, **Dial** 1st dest. digits, **Hear** dialtone
  - **Dial** TAC, **Dial** 2nd dest. digits
- 3. Single address with AAR/ARS
  - **Dial** mm-call button or FAC, **Hear** dialtone
  - **Dial** AAR/ARS, **Dial** destination digits
- 4. Dual address with AAR/ARS
  - **Dial** mm-multinbr button or FAC, **Hear** dialtone
  - **Dial** AAR/ARS, **Dial** 1st dest. digits, **Hear** dialtone
  - **Dial** AAR/ARS, **Dial** 2nd dest. digits
- 5. Single address with AAR/ARS and authorization code
  - **Dial** mm-call button or FAC, **Hear** dialtone
  - **Dial** AAR/ARS FAC, **Dial** destination digits, **Hear** stutter dialtone
  - **Dial** authorization code
- 6. Dual address with AAR/ARS and authorization code
  - **Dial** mm-multinbr button or FAC, **Hear** dialtone
  - **Dial** AAR/ARS FAC, **Dial** 1st dest. digits, **Hear** dialtone
  - **Dial** AAR/ARS FAC, **Dial** 2nd dest. digits, **Hear** stutter dialtone
  - **Dial** authorization code
- 7. Single address with TAC or AAR/ARS and CDR account code
  - **Dial** mm-call button or FAC, **Hear** dialtone
  - **Dial** CDR FAC, **Hear** dialtone
  - **Dial** CDR account code, **Hear** dialtone
  - **Dial** TAC or AAR/ARS, **Dial** destination digits
- 8. Dual address with TAC or AAR/ARS and CDR account code
  - **Dial** mm-multinbr button or FAC, **Hear** dialtone
  - **Dial** CDR FAC, **Hear** dialtone
  - **Dial** CDR account code, **Hear** dialtone
  - **Dial** TAC or AAR/ARS, **Dial** 1st dest. digits

■ **Dial TAC or AAR/ARS, Dial 2nd dest. digits**

**Receiving voice calls.** Any voice calls directed to the voice or data extension of a Basic multimedia complex will ring at the voice station.

**Receiving multimedia calls.** Any data calls directed to the voice or data extension of a Basic multimedia complex will ring at the multimedia equipped PC if it is available. You may answer the multimedia call at the PC and voice and video will connect to the PC. If the data endpoint is unavailable, the system verifies that the telephone of the complex is administered with the H.320 field set to **y**. If so, the system converts the call to voice and sends it to the telephone of the multimedia complex, where the call then alerts.

**Hourglass Tone.** When a voice station answers a converted multimedia call, the answering party may hear different things depending on the nature of the originator. If the origination is directly from an H.320 DVC system or if the originator is an Enhanced mode complex on a remote switch, an immediate audio path will not exist between the two parties. This is because the H.320 protocol must be established after the call is answered. It takes several seconds for the H.320 protocol to establish an audio path. During this interval the answering party will hear special ringback. When the audio path exists the special ringback will be removed and replaced with a short incoming call tone indicating that audio now exists. The combination of special ringback followed by incoming call tone is referred to as "hourglass tone." Hourglass tone is an indication to the answering party that they should wait for the H.320 call to establish audio.

**Early Answer.** The answering party may administer their station to avoid hearing hourglass tone. With the station form Early Answer field set to **y**, the system answers the incoming multimedia call on behalf of the station and establishes the H.320 protocol. After audio path has been established, the call will then alert at the voice station of the Basic complex destination. The station may then answer by going off-hook and will have immediate audio path. No hourglass tone will be heard by the answering party.

If the H.320 field is not set to **y** for the telephone of a Basic multimedia complex, H.320 calls alert at the multimedia endpoint until the caller drops. If an H.320 call is directed to a telephone with H.320 set to **n**, the system denies the call.

You can assign H.320 conversion to any voice station.

**Authorization.** Multimedia complexes require the same types of authorization (COR/COS) as standard telephones. If a call is addressed to the voice extension, the system checks the COR/COS of the telephone, whether the call is voice-only or multimedia. If a call is addressed to the data extension, the system checks the COR/COS of the data endpoint. If the call is subsequently redirected to the voice station, the system does a second COR/COS check for the authorization of the voice station. Calls originated from the PC use the COR/COS of the voice station.

## 11 Multimedia

### *Basic Mode MM complex*

Page 11-65

**Adjunct Switch Applications Interface .** ASAI is not expected to support call-association for data calls. Therefore Lucent Technologies does not recommend that you use ASAI for multimedia.

**Administered Connections.** Basic Multimedia endpoints may serve as the origination point or destination of an administered connection.

**Administration without Hardware.** You cannot use AWOH to administer a data module or the data endpoint in a multimedia complex. However, you can use AWOH to administer the telephone.

**Authorization and Barrier Codes.** Basic Mode multimedia users or off-premises PC users may not be able to respond to prompts for authorization or barrier codes. Multimedia endpoints do not recognize the prompts.

An on-premises user might be able to use Remote Access and enter the entire digit string at once before launching the call, but it would be better to eliminate the need for such codes for multimedia users who need to call off premises.

**Bridged Appearances.** Voice users can bridge onto a call if the user has a bridged appearance of a voice member of the call.

**Call redirection.** Calls directed to either member of the Basic multimedia complex are subject to redirection (coverage, forwarding). DEFINITY ECS converts calls to voice before sending them to coverage. Calls redirected through call forwarding maintain multimedia status if forwarded from the data endpoint.

**Conferencing .** A multimedia conference can consist of multimedia and voice-only conferees. All multimedia conferees are added to a multimedia conference by a voice-terminal user on the switch, who acts as the controller of the multimedia conference. When the controller is a Basic complex voice station, the controller must remain on the conference until all parties have joined. Once all endpoints are on the conference, the voice-terminal user may put the call on hold or drop, if the user wishes.

Video conferees can see only their local video and one other party. If more than two people are involved in a video conference, the person who is speaking is the one whose video appears to other conferees. The speaker's video shows the previous speaker. This changes dynamically as the speaker changes.

### **Creating a multi-party video conference**

All multimedia conferences must be controlled by a voice phone. Multimedia conferees may be added by calling the voice phone or by having the voice phone make a multimedia call to other DVC endpoints. The controller can then conference together individual parties to create a multimedia conference.

To set up a multimedia conference:

1. Determine who is going to be the conference controller.

## 11 Multimedia

### Basic Mode MM complex

Page 11-66

2. At the appointed time, the conference controller calls his or her telephone from the multimedia endpoint by dialing the 1-number extension. Once this call is established, the controller conferences in other calls as if this were a voice conference. The controller continues to add conferees in this manner until all conferees have joined, or until the number of conferees reaches the administered limit.
3. The conference controller may also add voice or multimedia parties to the conference spontaneously. The controller hits CONFERENCE, makes a voice or multimedia call to a new party. To make a multimedia call, the controller must originate a call using the mm-call button or FAC or the mm-multinbr button or FAC. After the new party begins alerting, the controller may hit CONFERENCE to add the party to the existing conference on hold.

**Coverage.** Multimedia calls to a Basic mode complex are subject to the same coverage criteria as voice calls and follow the coverage path administered for the voice station of the Basic multimedia mode complex.

If a plain voice station or a Basic mode complex is the covering party, the answering voice station will receive audio only. If all voice stations in the coverage path have the station form Early Answer field set to **n** and the originator of the multimedia call was not a local Enhanced mode complex, the answering station will hear hourglass tone.

If an Enhanced mode complex is the covering party, the answering voice station will receive voice and video. If all voice stations in the coverage path have the station form Early Answer field set to **n** and the originator of the multimedia call was not a local Enhanced mode complex, the answering station will hear hourglass tone.

**Coverage: Multimedia calls and off-net call coverage.** If the principal station's coverage path include a remote coverage point, the multimedia call will cover off-switch as voice only. If the call is unanswered off-switch and proceeds to the next coverage point on-switch, the multimedia nature of the call is preserved.

**Coverage: Multimedia calls and coverage to voice mail.** Voice mail systems such as AUDIX are typically the last point in a coverage path and are usually implemented as a hunt group. In order to guarantee that the originator of an H.320 multimedia call hears the voice mail greeting, the hunt group that defines the list of voice mail ports should have the Early Answer field on the hunt group set to **y**. This field will have no effect on voice calls to the voice mail system.

**Call Detail Recording.** Each channel of a 2-channel call generates a separate CDR record.

### Data Collaboration

Once you have established a multi-point video conference, multi-point T.120 data collaboration may be enabled for that call. This will allow all video parties on the current conference to collaborate.



## 11 Multimedia

### Basic Mode MM complex

Page 11-67

T.120 Data conferencing is made possible through the Expansion Services Module (ESM) which is an adjunct to the DEFINITY ECS. Up to six parties may participate in a single data conference, and up to 24 parties may use ESM facilities for data collaboration at any given time.

#### Adding data sharing to a video conference

1. Set up a multimedia conference.
2. Once a multimedia call is active, any voice station in the conference, can initiate data collaboration by pressing the mm-datacnf button. Or, to use the feature access code to initiate a data conference, press the Transfer button. A second line-appearance becomes active and you hear dial tone. Dial the multimedia data conference feature access code. Confirmation tone is heard and the system automatically reselects the held call appearance of the multimedia conference. The DEFINITY ECS will select a data rate which is acceptable to all H.320 DVC systems in the current call.

If the system does not have sufficient ESM resources available for all parties currently in the call, activation of T.120 data sharing will be denied. The mm-datacnf status lamp will flash denial or the mm-datacnf FAC will produce reorder.

3. Each H.320 DVC system in the conference call is joined to the data conference. On many DVC systems, the provided GUI may prompt the user with a dialog box, requesting the user to select a specific conference to join. With DEFINITY MMCH, there should only be one conference available to select.
4. The user must now use the PC's GUI to begin application sharing. The method for beginning application sharing or file transfer is different for each H.320 multimedia application. One of the H.320 DVC systems activates data sharing from the H.320 DVC vendor provided GUI. See your H.320 DVC system documentation for details.
5. The same H.320 DVC system as in step 4, opens an application, whiteboard, etc. to share and the image of the application is displayed on all H.320 DVC systems in the conference.

For details on how multiple users may control the shared application, see the vendor provided documentation for your specific H.320 DVC system.

6. To end the data collaboration session and retain the voice/video conference, **the station that selected the mm-datacnf button or FAC may press the mm-datacnf button or hit transfer and dial the mm-datacnf deactivation FAC.**

#### NOTE:

As of this writing, many endpoints do not respond correctly to ending the data collaboration session and retaining voice/video. Some H.320 DVC systems drop the entire call. It is recommended that once T.120 data sharing has been enabled for a conference, that it remain active for the duration of the conference call. When all

endpoints have dropped from the call, the T.120 resources will be released.

**Joining a multimedia conference after T.120 data sharing has been enabled.**

If a multimedia conference with T.120 data sharing is already active and it is desired to conference in a new video endpoint, the new video endpoint can be conferenced into the existing call. The new endpoint will be allowed into the data conference if there exists sufficient ESM resources for the new endpoint. The new endpoint will get voice/video and data sharing if the new endpoint supports the MLP data rate chosen by the system when T.120 data collaboration was activated. If the endpoint does not support the pre-existing MLP data rate, the new endpoint will only receive voice and video.

**Single switch data collaboration.** When all parties involved in data collaboration conference are located on the same physical DEFINITY ECS, there is no restriction on the type of user. The parties may be any combination of Enhanced multimedia complexes, Basic multimedia complexes or stand-alone H.320 DVC systems.

**Multi- switch data collaboration.** When all parties involved in data collaboration conference are **not** located on the same physical DEFINITY ECS, the parties located on the DEFINITY ECS hosting the data conference (i.e. the switch that activated mm-datacnf) may be any combination of Enhanced multimedia complexes, Basic multimedia complexes or stand-alone H.320 DVC systems. All parties on remote switches must not be Enhanced multimedia complexes: they must be Basic multimedia complexes or stand-alone H.320 DVC systems. Prior to originating or receiving a multimedia mode call, the mm-basic feature button or feature access code can be used to dynamically change an Enhanced mode complex into a Basic mode complex and back again.

**Forwarding of voice/multimedia calls.** In Basic mode you can forward calls from either the voice terminal or the multimedia endpoint. To forward a call from the multimedia endpoint:

1. At the PC's multimedia application, enter the call-forwarding feature access code (FAC)
2. Enter the forward-to number in the dialed number field on the endpoint software
3. Click the Dial button (or equivalent)

 **NOTE:**

The PC multimedia software will probably respond with a message that the call failed, since it does not recognize the FAC. In fact, DEFINITY ECS *does* receive the message, and forwards all multimedia calls addressed to the 1-number.

If a call is forwarded from the voice terminal, the call converts to voice first. If using the multimedia endpoint to forward, the calls arrive at the forwarded-to

## 11 Multimedia

### *Basic Mode MM complex*

Page 11-69

extension as a data call. Such calls continue to ring until answered or abandoned, rather than follow a coverage path.

Users can forward calls from the multimedia endpoint using the call forward FAC. You can also assign a call-forward button at the voice station to forward calls for the data endpoint. If a Basic multimedia complex has console permissions, that user can forward calls for others by dialing the FAC, the data extension, and then the forwarded-to number.

**Call Park.** A voice-terminal user can park any active call, voice or multimedia, and unpark the call from another telephone. Users cannot park or unpark calls using multimedia endpoints.

**Call Pickup.** Members of a pickup group can answer an H.320 call using a telephone after the call has been converted to voice. This is true for standard or directed call pickup.

**Consult.** After a call is converted to voice, consult may be used when transferring or conferencing the call.

**COR/COS.** The Class of Restriction and Class of Service for H.320 calls originated from a 1-number complex are the same as those of the telephone in the complex.

**Data Call Setup.** Basic complex multimedia endpoints are BRI data endpoints, and may use data call-setup procedures as provided by the software vendor.

**Data Hotline.** If endpoint software allows users to select the dial function without entering a number, the endpoint can be used for hotline dialing.

**Dial Access to Attendant.** Access to Attendant is blocked for a data call from a Basic mode multimedia endpoint.

**Data Trunk Groups.** Data trunk groups may be used to carry H.320 calls of a fixed (administered) bearer capability.

**Hold.** The voice station and multimedia endpoint of a Basic complex are each independent devices with respect to call control. When a Basic multimedia complex voice station executes hold only the voice station is held. If the user has conferenced their multimedia endpoint into a multimedia conference, activating hold will *not* disconnect the multimedia endpoint from the conference, it will only disconnect the Basic multimedia complex voice station. Executing hold with an Enhanced mode complex will fully disconnect voice and video from the current active call.

**Hunt Groups using Basic Mode complexes.** Since Basic mode complexes may receive point to point multimedia calls at the DVC system and voice calls to the station simultaneously, the voice station extension may be placed in any normal voice hunt group or ACD skill and the data extension may be placed in a simple hunt group made up of only data extensions.

## 11 Multimedia

### *Basic Mode MM complex*

Page 11-70

Basic mode complex data extensions or stand-alone data extensions may be used to create simple data hunt groups. Data extensions are not allowed in ACD hunt groups. It is recommended that you do not mix voice and data stations in a hunt group.

If you want multimedia calls to hunt to multimedia endpoints (i.e. 2B point to point data hunting), put the data extension in the hunt group. If you place the voice extension in a hunt group, only voice calls hunt to that extension. Multimedia calls to a hunt group with a Basic mode voice station as the hunt group member will *not* be offered to the DVC system of the Basic mode complex. If either the voice or data extension of a Basic mode complex is busy, the entire complex is considered busy for hunting purposes.

In order to guarantee that all members of a voice hunt group or skill can receive voice or multimedia calls, all members should have the H.320 field on the station form set to "y". Simple voice stations and Basic complex mode voice stations will receive voice only. Enhanced mode stations will receive voice and video.

The MM Early Answer field (on the Hunt Group form) tells the system to answer the incoming multimedia call and establish audio before it reaches the first member of the hunt group. Thus, when the talk path is established, the caller is able to speak with an agent immediately. This is not necessary for hunt groups comprised of data extensions.

**Hunting, Other considerations.** Agents that are part of a Basic mode complex may dial a feature access code to remove themselves from availability (and to indicate that they are available again) from both the multimedia endpoint and the telephone independently. This allows the voice member or the data member to be individually made unavailable. To make the data extension unavailable, the agent must dial the FAC from the DVC system.

CMS measurements may indicate unusually slow ASA, because of the time required for the system to establish early-answer before offering the call to an agent.

**Hunting Call association (routing).** Typically incoming voice calls consist of 2 B-channel calls to the same address, to provide greater bandwidth and better video resolution. DEFINITY ECS attempts to correctly pair up incoming calls and offer them as a unit to a single agent. MMCH uses call association to route both calls to the extension that answered the first call, regardless of how the call was routed internally.

Two 56K/64K data calls with the same calling party number to the same destination number are considered to be associated. The system makes every attempt to route both calls of a 2-channel call to the same answering party. If the first call terminates at a member of a hunt group, the second call does not have to hunt, but goes directly to the same member. In order for 2B multimedia calls to be correctly given to a single agent, incoming calls to the hunt group must have ANI information. The ANI information may be in the form of ISDN calling party number or DCS calling party number. Multimedia calls made on the same switch

## 11 Multimedia

### Basic Mode MM complex

Page 11-71

as the hunt group are easily associated. If multimedia calls into a hunt group have incorrect ANI information (i.e. all calls from switch X to switch Y include the LDN for switch X), then as the volume of calls increases, the number of mis-associated calls will increase. If multimedia calls into a hunt group have no ANI information, the switch will never associate pairs of calls and all calls will be treated independently and routed to separate agents. This is not a recommended configuration.

**Hunting with Multimedia vectors.** Very often, calls are routed to hunt groups or skills via a vector. The existing VDNs and vectors which exist for routing voice calls can be used to route multimedia calls.

In order to use a vector for multimedia calls that will terminate to voice stations, you must set the Multimedia field on the vector form to **y**. This field has no effect on voice calls routing through the vector. This field will cause multimedia calls routed through the vector to receive early answer treatment prior to processing the vector steps. This provides a talk path to the caller for announcements or immediate conversation with an agent.

#### NOTE:

Vectors which have the Multimedia field set to **y** must eventually route to hunt groups, skills or numbers which are voice extensions. A vector with the multimedia field set to **y** should never be set up to route to a hunt group or number which is a data extension.

When a vector is used to route video (56K/64K) calls to a hunt group comprised of data extensions, the vector *must* have the multimedia field set to **n**.

**Intercept Treatment.** H.320 calls that receive intercept treatment are treated like other data calls. H.320 calls cannot be directed to an attendant for service because the attendant cannot have H.320 conversion service.

**ISDN Trunk Groups.** Lucent Technologies highly recommends that you use ISDN trunks for multimedia calls. ISDN PRI trunks allow complete 1-number access for an Enhanced multimedia complex. ANI provided over PRI trunks allows correct routing of multiple bearer channels to the correct destination device. ISDN also provides the bearer capability on a call by call basis which can be used to distinguish voice calls from multimedia calls.

**Malicious Call Trace.** If a malicious call terminates at a Basic multimedia complex endpoint, the user can dial the feature access code from the telephone to activate malicious call trace, followed by the extension of the multimedia endpoint. If the user does not dial the multimedia extension, MCT traces any call held on the telephone.

**Message Waiting.** Message Waiting indication is handled at the telephone. Because H.320 calls are converted to voice before going to coverage, all messages are voice only.

## 11 Multimedia

### *Basic Mode MM complex*

Page 11-72

**Night Service.** Incoming Basic mode data calls follow established night-service processing for data calls.

**Remote Access.** The switch does not prevent Basic multimedia complexes from attempting to use remote access. However, these Basic mode endpoints will most likely not be able to dial the necessary codes.

**Station Hunting .** Basic mode data calls to endpoints that have an extension administered in the hunt-to-station field hunt based on established hunting criteria. The call is converted to voice before station hunting.

**Tenant Partitioning.** Permission to make multimedia calls or add parties of any type to a conference is subject to standard tenant-partitioning restrictions.

**Terminating Extension Groups.** Basic mode data calls to a TEG are converted to voice and can terminate only at a voice endpoint. Effectively, DEFINITY ECS treats the multimedia-complex extension as a voice-only endpoint.

**Telephone Display.** Display information for calls to or from a Basic multimedia complex contains the 1-number.

## Enhanced Mode MM complex

---

The Enhanced multimedia complex provides a much greater unified and integrated interface for control of voice and multimedia calls. The multifunction voice station is used to control all calls, whether voice or multimedia. The H.320 desktop video system is used to present the video stream, data stream and (optionally) audio stream to the user. The H.320 desktop video system is *not* used for call control. The Enhanced multimedia complex allows the multifunction voice station to handle voice or multimedia calls in an almost identical manner. Each call appearance on the voice station may represent a voice or multimedia call, allowing multiple voice or multimedia calls to be present simultaneously on the station. The user may manage the separate call appearances without regard to the voice or multimedia nature of the specific call. The standard HOLD/TRANSFER/CONFERENCE/DROP actions may be applied to any call without regard to the voice or multimedia nature of the call.

### 1-number access

1-number access permits originating users to make voice or multimedia calls to an Enhanced multimedia complex by dialing the same number for either type of call. The number may be the voice station extension or the data module extension. If the incoming call is a voice call, DEFINITY ECS alerts the station of an incoming voice call. If the incoming call is 56K or 64K data call, DEFINITY ECS recognizes it as a multimedia call and inserts resources to terminate the H.320 protocol and then alerts the voice station with a multimedia call.

Calls originating on the same switch as the Enhanced mode complex destination may always use 1-number access for voice or video. In order to take advantage of 1-number access for calls originating from a remote location, the incoming calls must arrive over ISDN-PRI trunks. If the system is setup with separate non-PRI digital facilities for data, multimedia calls must be made to the data extension of the Enhanced mode complex.

AVD (Alternate voice/data) trunk groups cannot be used to provide 1-number access with MMCH. If the AVD trunk group has a BCC of 0, all calls arriving over the AVD trunk to the Basic mode complex will be assumed to be voice calls. If the AVD trunk group has a BCC of 1 or 4, all calls arriving over the AVD trunk to the Basic mode complex will be assumed to be multimedia calls.

### ORIGINATION

The basic call sequence from an Enhanced mode complex is to originate a multimedia call and alert the destination. When the destination answers the call, the originating station's H.320 desktop video system will be alerted (that is, called by the switch to establish the service link). If the H.320 desktop video system is not configured for auto-answer, the user must answer the H.320 calls via the DVC GUI. If the H.320 DVC is configured for auto-answer, no action is needed via the DVC GUI. It is recommended, but not required, that Enhanced mode complexes place their desktop video system into an auto-answer mode of operation. If the far-end is providing a video signal, the 2-way video will be observed. If the

## 11 Multimedia

### *Enhanced Mode MM complex*

Page 11-74

destination is not providing a video signal (call was answered by a simple voice station), then loopback video will be provided at the Enhanced mode complex originator. The audio signal will exist at the handset of the voice station. The audio signal may be moved to the H.320 DVC system via activation of a mm-pcaudio button on the voice station. See the section below on mm-pcaudio.

**Hourglass tone.** The originating party may hear different things when the incoming multimedia call is answered depending on the nature of the answering party. If the call is being answered directly by an H.320 DVC system or if the answering party is an Enhanced mode complex on a remote switch, an immediate audio path will not exist between the two parties. This is because the H.320 protocol must be established after the call is answered. It takes several seconds for the H.320 protocol to establish an audio path. During this interval the originating party will hear special ringback. When the audio path exists the special ringback will be removed and replaced with a short incoming call tone indicating that audio path now exists. The combination of special ringback followed by incoming call tone is referred to as "hourglass tone." Hourglass tone is an indication to the originating party that they should wait for the H.320 call to establish audio.

#### **- originating voice calls**

Voice calls are originated from the voice station of an Enhanced mode complex in the normal manner as for any voice station.

#### **- originating multimedia calls**

Multimedia calls from an Enhanced multimedia complex are originated from the VOICE STATION, NOT the H.320 desktop video system. All multimedia originations require the user to indicate the multimedia nature of the call prior to providing any address digits. There are several different ways to originate a multimedia call from the voice station.

1. **mm-call (Multimedia Call) button.** If the station has an mm-call button administered, the user goes off-hook and selects the mm-call button. The user may select the mm-call button and then go off-hook. If the user has a speakerphone on the station, the user may originate the call simply by selecting the mm-call button. The speakerphone will automatically be placed off-hook and dialtone will be heard. Upon selection of the mm-call button, the mm-call status lamp (green led) will light steadily, indicating a multimedia call.

The user now dials the destination address digits. The destination address may be provided by dialing digits, using abbreviated dial entries, last number dialed, station busy indicators, etc. Originating a multimedia call with the mm-call button will originate a call according to the Default Multimedia Parameters selected on the System Parameters Features form. This default parameter will be either 2x56 or 2x64. The bearer capability of the multimedia calls will either be 56K or 64K and the bandwidth will be 2B channels.



For calls with a bandwidth of 2B, use of the mm-call button to originate will cause the same destination address to be used for both channels of the 2B call. See the section below on the mm-multinbr button/FAC for information on originating a 2B call where the destination has a different address for each B-channel.

 **NOTE:**

The mm-call feature button is generally used by stations that are part of an Enhanced multimedia complex, but may be used by any station to originate a multimedia call.

2. **Multimedia Call feature Access Code.** For stations that do not have an administered mm-call button, the Multimedia call feature access code may be used instead. The user goes off-hook on the station, waits for dialtone, then dials the MM-call FAC, receives dialtone again and then dials the call normally. The destination address may be provided by dialing digits, using abbreviated dial entries, last number dialed, station busy indicators, etc.

Originating a multimedia call with the mm-call button will originate a call according to the Default Multimedia Parameters selected on the System Parameters Features form. This default parameter will be either 2x56 or 2x64. The bearer capability of the multimedia calls will either be 56K or 64K and the bandwidth will be 2B channels.

For calls with a bandwidth of 2B, use of the mm-call button to originate will cause the same destination address to be used for both channels of the 2B call. See the section below on the mm-multinbr button/FAC for information on originating a 2B call where the destination has a different address for each B-channel.

 **NOTE:**

The mm-call feature access code is generally used by stations that are part of an Enhanced multimedia complex, but may be used by any station to originate a multimedia call.

3. **mm-multinbr (Multimedia Multi-number) button.** The mm-multinbr button is similar to the mm-call button. It allows origination of a multimedia call from a voice station. It is used when the destination being dialed requires a different address for each of the 2 B-channels. An example of this is Central Office provided ISDN-BRI. This type of BRI line is provisioned with separate listed directory numbers for each B-channel. In order to make a 2B multimedia call to such a device, two sets of addresses must be entered.

The user goes off-hook and selects the mm-multinbr button. The user may select the mm-multinbr button and then go off-hook. If the user has a speakerphone on the station, the user may originate the call simply by selecting the mm-multinbr button. The speakerphone will automatically be placed off-hook and dialtone will be heard. Upon selection of the mm-multinbr button, the mm-multinbr and mm-call (if present) status lamp

## 11 Multimedia

### Enhanced Mode MM complex

Page 11-76

(green led) should become solid. The user now dials the first destination address digits. The destination address may be provided by dialing digits, using abbreviated dial entries, last number dialed, etc. The system will provide dialtone after the first address has been completed. The user now dials the second destination address digits. The destination address may be provided by dialing digits, using abbreviated dial entries, last number dialed, etc. After the 2nd address has been collected the mm-multinbr status lamp will go off.

Originating a multimedia call with the mm-multinbr button will originate a call according to the Default Multimedia Parameters selected on the System Parameters Features form. This default parameter will be either 2x56 or 2x64. The bearer capability of the multimedia calls will either be 56K or 64K and the bandwidth will be 2B channels.

#### NOTE:

The mm-multinbr feature button is generally used by stations that are part of an Enhanced multimedia complex, but may be used by any station to originate a dual address multimedia call.

4. **Multimedia Multi-number Call feature Access Code.** For stations that do not have an administered mm-multinbr button, the Multimedia Multi-number call feature access code may be used instead. It allows origination of a multimedia call from a voice station. It is used when the destination being dialed requires a different address for each of the 2 B-channels. An example of this is Central Office provided ISDN-BRI. This type of BRI line is provisioned with separate listed directory numbers for each B-channel. In order to make a 2B multimedia call to such a device, two sets of addresses must be entered.

The user goes off-hook and dials the MM-multinbr feature access code. Upon dialing of the MM-multinbr FAC, the mm-call (if present) status lamp (green led) should become solid. The user now dials the first destination address digits. The destination address may be provided by dialing digits, using abbreviated dial entries, last number dialed, etc. The system will provide dialtone after the first address has been completed. The user now dials the second destination address digits. The destination address may be provided by dialing digits, using abbreviated dial entries, last number dialed, etc.

Originating a multimedia call with the MM-multinbr FAC will originate a call according to the Default Multimedia Parameters selected on the System Parameters Features form. This default parameter will be either 2x56 or 2x64. The bearer capability of the multimedia calls will either be 56K or 64K and the bandwidth will be 2B channels.

#### NOTE:

The mm-multinbr FAC is generally used by stations that are part of an Enhanced multimedia complex, but may be used by any station to originate a dual address multimedia call.

11 Multimedia

Enhanced Mode MM complex

Page 11-77

5. **Multimedia parameter selection feature access code.** This FAC is used to originate a multimedia call that wishes to use a different bearer and bandwidth than the system default. For example, if the system has a default multimedia parameter of 2x64 and the user wishes to make a call to a destination that is known to only have 56K digital facilities, the MM parameter selection FAC can be used to select a bearer and bandwidth of 2x56 for this specific call.

The MM parameter selection FAC may be used in conjunction with the mm-multinbr button or FAC to make a single or dual address multimedia call at the desired bearer and bandwidth. The user goes off-hook and dials the MM-parameter selection feature access code. Dialtone is returned. The user enters a single digit, 1 or 2, where 1 = 2x64, 2 = 2x56. All other digits will produce reorder. Dialtone is returned. Upon dialing of the MM-parameter selection FAC, the mm-call (if present) status lamp (green led) should become solid. The user may indicate a dual-address call at this point with the mm-multinbr button or FAC. The user now dials one or two sets of destination address digits. The destination address may be provided by dialing digits, using abbreviated dial entries, last number dialed, etc.



**NOTE:**

The mm-parameter selection FAC is generally used by stations that are part of an Enhanced multimedia complex, but may be used by any station to originate a dual address multimedia call.

6. Dialing sequences that include TACs, AAR, ARS, Authorization codes, CDR account codes, FRLS
  1. Single address with TAC
    - **Dial** mm-call button or FAC, **Hear** dialtone
    - **Dial** TAC, **Dial** destination digits
  2. Dual address with TAC
    - **Dial** mm-multinbr button or FAC, **Hear** dialtone
    - **Dial** TAC, **Dial** 1st dest. digits, **Hear** dialtone
    - **Dial** TAC, **Dial** 2nd dest. digits
  3. Single address with AAR/ARS
    - **Dial** mm-call button or FAC, **Hear** dialtone
    - **Dial** AAR/ARS, **Dial** destination digits
  4. Dual address with AAR/ARS
    - **Dial** mm-multinbr button or FAC, **Hear** dialtone
    - **Dial** AAR/ARS, **Dial** 1st dest. digits, **Hear** dialtone
    - **Dial** AAR/ARS, **Dial** 2nd dest. digits
  5. Single address with AAR/ARS and authorization code

## 11 Multimedia

### Enhanced Mode MM complex

Page 11-78

- **Dial** mm-call button or FAC, **Hear** dialtone
  - **Dial** AAR/ARS FAC, **Dial** destination digits, **Hear** stutter dialtone
  - **Dial** authorization code
6. Dual address with AAR/ARS and authorization code
- **Dial** mm-multinbr button or FAC, **Hear** dialtone
  - **Dial** AAR/ARS, **Dial** 1st dest. digits, **Hear** dialtone
  - **Dial** AAR/ARS, **Dial** 2nd dest. digits, **Hear** stutter dialtone
  - **Dial** authorization code
7. Single address with TAC or AAR/ARS and CDR account code
- **Dial** mm-call button or FAC, **Hear** dialtone
  - **Dial** CDR FAC, **Hear** dialtone
  - **Dial** CDR account code, **Hear** dialtone
  - **Dial** TAC or AAR/ARS, **Dial** destination digits
8. Dual address with TAC or AAR/ARS and CDR account code
- **Dial** mm-multinbr button or FAC, **Hear** dialtone
  - **Dial** CDR FAC, **Hear** dialtone
  - **Dial** CDR account code, **Hear** dialtone
  - **Dial** TAC or AAR/ARS, **Dial** 1st dest. digits
  - **Dial** TAC or AAR/ARS, **Dial** 2nd dest. digits

### Answering

The user actions required to answer voice or multimedia calls at an Enhanced multimedia complex are identical if the H.320 DVC system is configured for auto-answer. If the H.320 DVC system is not configured for auto-answer an additional step is required. See answering multimedia calls below. It is recommended, but not required, that Enhanced mode complexes place their desktop video system into an auto-answer mode of operation.

### Answering voice calls

Incoming voice calls will alert at the voice station of the Enhanced multimedia complex in the normal manner. Standard alerting and call appearance flashing will occur. They are answered in the normal manner by selecting the alerting call appearance and going off-hook on the voice station.

### Answering multimedia calls

Incoming multimedia calls will alert at the voice station of the Enhanced multimedia complex in the same manner as voice calls with one addition. If the alerting station has an administered mm-call button and the alerting call

## 11 Multimedia

### *Enhanced Mode MM complex*

Page 11-79

appearance is the selected call appearance (i.e. the red led is lit, on the alerting call appearance), then the mm-call button status lamp will go on indicating that the call on the selected call appearance is a multimedia call.

The incoming multimedia call is answered in the normal manner by selecting the alerting call appearance and going off-hook on the voice station. If the H.320 DVC system for the answering party is configured for auto-answer, no other action is needed to complete the multimedia call. If the H.320 DVC system for the answering party is not configured for auto-answer, the H.320 DVC system will alert and must also be answered by the user. It is recommended, but not required, that Enhanced mode complexes place their desktop video system into an auto-answer mode of operation.

If the originating party is providing a video signal, then a complete 2-way multimedia call will exist. If the originating party is not providing a video signal, the answering party will receive loopback video. The audio signal will exist at the handset of the voice station. The audio signal may be moved to the H.320 DVC system via activation of a mm-pcaudio button on the voice station. (See the section below on mm-pcaudio [11-83](#), [11-52](#).)

**Hourglass Tone.** The answering party may hear different things when the incoming multimedia call is answered depending on the nature of the originator. If the origination is directly from an H.320 DVC system or if the originator is an Enhanced mode complex on a remote switch, an immediate audio path will not exist between the two parties. This is because the H.320 protocol must be established after the call is answered. It takes several seconds for the H.320 protocol to establish an audio path. During this interval the answering party will hear special ringback. When the audio path exists the special ringback will be removed and replaced with a short "incoming call tone" indicating that audio now exists. The combination of special ringback followed by incoming call tone is referred to as "hourglass tone." Hourglass tone is an indication to the answering party that they should wait for the H.320 call to establish audio.

**Early Answer.** The answering party may administer their station in such a way as to avoid hearing hourglass tone. If the station form has set the Early Answer field to **y**, then the system will answer the incoming multimedia call on behalf of the station and proceed to establish the H.320 protocol. After audio path has been established, the call will then alert at the voice station of the Enhanced mode complex destination. The station may then answer by going off-hook and will have immediate audio path. No hourglass tone will be heard by the answering party.

### **- multiple call appearance operation**

With an Enhanced mode complex all calls to or from the complex are controlled via the voice station. Each voice or multimedia call has its own call appearance which may be selected without regard for the nature of the call using the specific call appearance. This allows a multifunction station to control multiple voice or multimedia calls in exactly the same way they would control multiple voice calls.

## 11 Multimedia

### Enhanced Mode MM complex

Page 11-80

As an example, a user may originate a simple voice call on the first call appearance. A multimedia call may then arrive on the second call appearance. The user activates HOLD on the first call appearance and selects the second call appearance to answer the multimedia call. The user may then activate HOLD on the second call appearance and reselect the first call appearance or select a third call appearance and originate another call.

### - creating a multi-party video conference

An Enhanced multimedia complex can create a spontaneous video conference in the same way that a spontaneous voice conference is created. Given an active call, the user activates the CONFERENCE button. This puts the current call on HOLD and activates a new call appearance. The user makes a multimedia call according to the instructions for originating a multimedia call and then selects CONFERENCE to combine or merge the two call appearances. This results in a 3-way conference.

If all three parties are video equipped, then a 3-way video conference results. Conference members see the current speaker on video. The current speaker sees the last speaker on video. If one of the parties is not video equipped, then a 3-way audio conference exists and the two video equipped parties have 2-way video. The CONFERENCE action may be repeated until 6 parties have been conferenced together. The 6 parties may be any mix of voice or video, local or remote parties.

The following steps create a multi-party voice/video conference:

1. Enhanced mode complex station A originates a multimedia call to, or receives a multimedia call from, party B. Station A and party B have 2-way voice and video.
2. Station A, activates CONFERENCE.
3. Station A originates a multimedia call (i.e. uses the mm-call button/FAC/etc.) and dials the party to be added, Enhanced multimedia complex C.
4. Party C, answers the call from station A.
5. Station A selects CONFERENCE to complete the 3-way conference. Parties A,B and C will be in a 3-way voice/video conference.

### NOTE:

If party C is another Enhanced mode complex on the same switch as station A, station A does not need to indicate a multimedia call prior to dialing the new party in step 3. While A consults with C, the call will be audio only. When A completes the conference in step 5, party C's video will be activated.

A multi-party video conference uses voice activated switching to determine which parties are seen. The current speaker is seen by all other parties. The current speaker sees the previous speaker.

Additional voice or video parties may be added by repeating these steps.

### Data Collaboration

Once you have established a multi-point video conference, multi-point T.120 data collaboration may be enabled for that call. This will allow all video parties on the current conference to collaborate.

T.120 Data conferencing is made possible through the Expansion Services Module (ESM) which is an adjunct to the DEFINITY ECS. Up to six parties may participate in a single data conference, and up to 24 parties may use ESM facilities for data collaboration at any given time.

The following steps add data sharing to a video conference:

1. Set up a multimedia conference.
2. Once a multimedia call is active, any member can initiate data collaboration by pressing the mm-datacnf button. Or, to use the feature access code to initiate a data conference, press the Transfer button. A second line-appearance becomes active and you hear dial tone. Dial the multimedia data conference feature access code. Confirmation tone is heard and the system automatically reselects the held call appearance of the multimedia conference. The DEFINITY ECS will select an MLP data rate which is acceptable to all H.320 DVC systems in the current call.

If the system does not have sufficient ESM resources available for all parties currently in the call, activation of T.120 data sharing will be denied. The mm-datacnf status lamp will flash denial or the mm-datacnf FAC will produce reorder.

3. Each H.320 DVC system in the conference call is joined to the data conference. On many DVC systems, the provided GUI may prompt the user with a dialog box, requesting the user to select a specific conference to join. With DEFINITY MMCH, there should only be one conference available to select.
4. The user must now use the PC's GUI to begin application sharing. The method for beginning application sharing or file transfer is different for each H.320 multimedia application. One of the H.320 DVC systems activates data sharing from the H.320 DVC vendor provided GUI. See your H.320 DVC system documentation for details.
5. The same H.320 DVC system as in step 4, opens an application, whiteboard, etc. to share and the image of the application is displayed on all H.320 DVC systems in the conference.

For details on how multiple users may control the shared application, see the vendor provided documentation for your specific H.320 DVC system.

6. To end the data collaboration session and retain the voice/video conference, the station that selected the mm-datacnf button or FAC may press the mm-datacnf button or hit transfer and dial the mm-datacnf deactivation FAC.



**NOTE:**

Currently, many endpoints do not respond correctly to ending the data collaboration session and retaining voice/video. Some H.320 DVC systems drop the entire call. It is recommended that once T.120 data sharing has been enabled for a conference, that it remain active for the duration of the conference call. When all endpoints have dropped from the call, the T.120 resources will be released.

**Joining a multimedia conference after T.120 data sharing has been enabled.**

If a multimedia conference with T.120 data sharing is already active and it is desired to conference in a new video endpoint, the new video endpoint can be conferenced into the existing call. The new endpoint will be allowed into the data conference if there exists sufficient ESM resources for the new endpoint. The new endpoint will get voice/video and data sharing if the new endpoint supports the data rate chosen by the system when T.120 data collaboration was activated. If the endpoint does not support the pre-existing data rate, the new endpoint will only receive voice and video.

**Activating HOLD while on a T.120 data collaboration conference.**

If an Enhanced multimedia complex is active on a multimedia call and the call has activated T.120 data collaboration, the user should be receiving voice/video and data. If the station places this existing call on hold, audio and video will be disconnected for the current call. The data collaboration portion of the call will remain intact and unaffected. While this T.120 data conference is on hold, the user will only be allowed to receive audio on all other call appearances. Thus a user is limited to one call appearance that has T.120 data collaboration active.

**Single switch data collaboration.** When all parties involved in data collaboration conference are located on the same physical DEFINITY ECS, there is no restriction on the type of user. The parties may be any combination of Enhanced multimedia complexes, Basic multimedia complexes or stand-alone H.320 DVC systems.

**Multi- switch data collaboration.** When all parties involved in data collaboration conference are *not* located on the same physical DEFINITY ECS, the parties located on the DEFINITY ECS hosting the data conference (i.e. the switch that activated mm-datacnf) may be any combination of Enhanced multimedia complexes, Basic multimedia complexes or stand-alone H.320 DVC systems.



**NOTE:**

All parties on remote switches must not be Enhanced multimedia complexes. They must be Basic multimedia complexes or stand-alone H.320 DVC systems.

Prior to originating or receiving a multimedia mode call, the mm-basic feature button or feature access code can be used to dynamically change an Enhanced mode complex into a Basic mode complex and back again.



## Voice station audio vs. H.320 DVC system audio

When an Enhanced mode complex originates or receives a voice or multimedia call, the call is originated with the station handset or answered with the station handset. The audio path will be through the handset. If the user's H.320 DVC system has speakers and a microphone, the user may wish to use the H.320 DVC system for audio in much the same manner as a built-in or separate telephone speakerphone. The user can move the station's audio to the H.320 DVC system by selecting an mm-pcaudio feature button on the voice station. There is no feature access code for this function.

The mm-pcaudio feature button works very much like a speakerphone on/off button. If the station is off-hook and selects mm-pcaudio, audio is directed to the PC DVC system. The switch-hook may be placed on-hook. If the handset is taken off-hook, the audio moves back to the handset. If the mm-pcaudio button is selected while audio is already on the DVC system and the handset is on-hook, this acts as a speakerphone off action and disconnects the current call.

The mm-pcaudio feature button may be used for voice as well as multimedia calls. If the mm-pcaudio feature button is selected while on a voice only call, the DVC system is alerted and brought into the call. No video will be transmitted or displayed. Audio will be directed through the PC DVC system.

## Switching between Basic and Enhanced modes

There may exist occasions when an Enhanced mode complex needs to switch to Basic mode operation temporarily. One example is when a user wishes to make a direct point to point multimedia call originated directly from the H.320 DVC. Basic mode operation allows this functionality at the expense of losing multimedia call handling capabilities (i.e. hold/xfer/conf). To switch from Enhanced mode to Basic mode, the station may either select a mm-basic feature button or dial the mm-basic feature access code. Both of these actions are valid only if the Enhanced mode station has no multimedia calls active.

When in Basic mode, the status lamp for the mm-basic button, if present, will be on solid. The mm-basic feature button acts as a toggle. If the status lamp is on, when the button is selected, the lamp will go off and the station will return to Enhanced mode. The mm-enhanced feature access code will set the state of the station back to Enhanced. Switching to Enhanced mode is only valid if the associated H.320 DVC system is idle.

### NOTE:

Toggling between Basic and Enhanced mode changes the station's administered Multimedia mode. When in Basic mode this field on the station form will show *basic*. When in Enhanced mode this field on the station form will show *enhanced*. The current station Multimedia mode will be saved to translation when a **save translation** command is executed.

## 11 Multimedia

*Enhanced Mode MM complex*

Page 11-84

### Forwarding of voice and multimedia calls

The Enhanced multimedia mode complex voice station may use the existing standard call forwarding mechanisms to activate forwarding for voice calls. If the forwarding destination is on the same switch then this will also forward multimedia calls as multimedia calls to the destination. If the forwarding destination is off switch, multimedia calls will forward off switch as voice only calls. This is appropriate when the user will be at a location that is not able to receive multimedia calls.

To forward multimedia calls off switch as multimedia calls, the user must activate multimedia call forwarding. This may be done with an mm-cfwd button or feature access code. The user may also activate standard voice call forwarding and select the mm-call button prior to entering the forwarding address.

### Coverage

Multimedia calls to an Enhanced mode complex are subject to the same coverage criteria as voice calls and follow the coverage path administered for the voice station of the Enhanced multimedia mode complex.

If a plain voice station or a Basic mode complex is the covering party, the answering voice station will receive audio only. If all voice stations in the coverage path have the station form Early Answer field set to **n** and the originator of the multimedia call was not a local Enhanced mode complex, the answering station will hear hourglass tone.

If an Enhanced mode complex is the covering party, the answering voice station will receive voice and video. If all voice stations in the coverage path have the station form Early Answer field set to **n** and the originator of the multimedia call was not a local Enhanced mode complex, the answering station will hear hourglass tone.

**Multimedia calls and off-net call coverage.** If the principal station's coverage path include a remote coverage point, the multimedia call will cover off-switch as voice only. If the call is unanswered off-switch and proceeds to the next coverage point on-switch, the multimedia nature of the call is preserved.

**Multimedia calls and coverage to voice mail.** Voice mail systems such as AUDIX are typically the last point in a coverage path and are usually implemented as a hunt group. In order to guarantee that the originator of an H.320 multimedia call hears the voice mail greeting, the hunt group that defines the list of voice mail ports should have the Early Answer field on the hunt group set to **y**. This field will have no effect on voice calls to the voice mail system.

### Hunt Groups using Enhanced Mode Complexes

When creating hunt groups with Enhanced multimedia mode complexes, only the station extension should ever be entered as a hunt group member. Any hunt group or ACD skill can include the voice station of an Enhanced multimedia complex as a member. The data extension of an Enhanced mode complex

## 11 Multimedia

### *Enhanced Mode MM complex*

Page 11-85

should never be entered as any hunt group member. A hunt group or skill may have a mix of members that are stand-alone stations and Enhanced mode complex stations. In order to guarantee that all members of the hunt group or skill can receive voice or multimedia calls, all members should have the H.320 field on the station form set to **y**. Simple voice stations will receive voice only. Enhanced mode stations will receive voice and video.

The MM Early Answer field (on the Hunt Group form) tells the system to answer an incoming multimedia call and establish audio before it reaches the first member of the hunt group. Thus, when the talk path is established, the caller is able to speak with an agent immediately.

**Other considerations.** CMS measurements may indicate unusually slow ASA, because of the time required for the system to establish early-answer before offering the call to an agent.

**Call association (routing).** Typically incoming voice calls consist of 2 B-channel calls to the same address, to provide greater bandwidth and better video resolution. DEFINITY ECS attempts to correctly pair up incoming calls and offer them as a unit to a single agent. MMCH uses call association to route both calls to the extension that answered the first call, regardless of how the call was routed internally.

Two 56K/64K data calls with the same calling party number to the same destination number are considered to be associated. The system makes every attempt to route both calls of a 2-channel call to the same answering party. If the first call terminates at a member of a hunt group, the second call does not have to hunt, but goes directly to the same member.

In order for 2B multimedia calls to be correctly given to a single agent, incoming calls to the hunt group must have ANI information. The ANI information may be in the form of ISDN calling party number or DCS calling party number. Multimedia calls made on the same switch as the hunt group are easily associated. If multimedia calls into a hunt group have insufficient ANI information (i.e. all calls from switch X to switch Y include the LDN for switch X), then as the volume of calls increases the number of mis-associated calls will increase. If multimedia calls into a hunt group have no ANI information, the switch will never associate pairs of calls and all calls will be treated independently and routed to separate agents. This is not a recommended configuration.

**Multimedia vectors.** Very often, calls are routed to hunt groups or skills via a vector. The existing VDNs and vectors which exist for routing voice calls can be used to route multimedia calls.

In order to use a vector for multimedia calls, you must set the Multimedia field on the vector form to **y**. This field has no effect on voice calls routing through the vector. This field will cause multimedia calls routed through the vector to receive early answer treatment prior to processing the vector steps. This provides a talk path to the caller for announcements or immediate conversation with an agent.

 NOTE:

Vectors which have the Multimedia field set must eventually route to hunt groups, skills or numbers which are voice extensions. A vector with the multimedia field set to y should never be set up to route to a hunt group or number which is a data extension.

## Interactions

Interactions are listed here only if the operation is different from standard.

- Administered Connections

An Enhanced multimedia complex voice station may serve as the origination point or destination of an administered connection. If the Multimedia call feature access code is included in the administration of the administered connection, this will result in a video AC.

An Enhanced multimedia complex H.320 DVC system may not serve as the origination point of an administered connection.

- Administration without Hardware

You cannot use AWOH to administer a data module or the data endpoint in a multimedia complex. However, you can use AWOH to administer the telephone.

- Bridged Appearances

Enhanced multimedia complex voice station users can bridge onto a call if the user has a bridged appearance. If the bridged appearance is for a multimedia call, selecting the bridged appearance will result in a multimedia call.

- Call Detail Recording

Each channel of a 2-channel multimedia call generates a separate CDR record that is tagged as data.

- Call Park

Any station can park a multimedia call, and unpark the call from another telephone. If a multimedia call is unparked by an Enhanced mode complex station, a multimedia call will result. Users cannot park or unpark calls using multimedia endpoints.

- Call Pickup

Any member of a pickup group can answer a multimedia call after the call has begun alerting at a station call appearance. If the station picking up the call is an Enhanced mode complex station and the call is multimedia, a multimedia call will result. This is true for standard or directed call pickup.

- Consult

After a multimedia call has been answered, consult may be used when transferring or conferencing the call.

## 11 Multimedia

### *Enhanced Mode MM complex*

Page 11-87

- **COR/COS**

The Class of Restriction and Class of Service for a multimedia call originated from an Enhanced multimedia complex are those of the voice station in the complex.

- **Data Call Setup**

An Enhanced mode multimedia H.320 DVC system may not originate calls from the DVC system. All calls, both voice or video are originated from the voice station.

- **Data Hotline**

An Enhanced multimedia complex H.320 DVC endpoint may not be used to originate a call for hotline dialing. In order to setup a video hotline function with an Enhanced mode complex, the hotline number administered for the voice station should include the Multimedia call feature access code.

- **Data Trunk Groups**

Data trunk groups may be used to carry H.320 calls of a fixed (administered) bearer capability.

- **ISDN Trunk Groups**

Lucent Technologies highly recommends that you use ISDN trunks for multimedia calls. ISDN PRI trunks allow complete 1-number access for an Enhanced multimedia complex. ANI provided over PRI trunks allows correct routing of multiple bearer channels to the correct destination device. ISDN also provides the bearer capability on a call by call basis that can be used to distinguish voice calls from multimedia calls.

- **Night Service**

Incoming H.320 calls follow established night-service processing for data calls.

- **Remote Access**

The switch does not prevent Enhanced multimedia complexes from attempting to use remote access. However, these endpoints will most likely not be able to dial the necessary codes.

- **Station Hunting**

Multimedia calls to Enhanced mode complex voice stations that have an extension administered in the hunt-to-station field hunt based on established hunting criteria. If the hunt-to-station is also an Enhanced mode complex station, a multimedia call will result when the call is answered.

- **Terminating Extension Groups**

A multimedia call to a TEG may be answered by any member of the TEG. If the member answering the call is an Enhanced mode complex station, a multimedia call will result.

11 Multimedia

Enhanced Mode MM complex

Page 11-88

- Telephone Display

Display information for calls to or from an Enhanced multimedia complex contains the display information associated with the voice station.

## Troubleshooting

If one channel of a 2 B-channel call goes down, your choices are to continue with reduced transmission quality, or to hang up the call and start over. It is not possible to re-establish the second channel while the call is still active.

If you cannot share data with others, it may be that both parties do not have the same endpoint software. This is true for some data collaboration, but most whiteboard and file transfer software implementations are compatible.

## Monitoring MMCH

This section briefly discusses some of the commands you can use to monitor multimedia complexes and conferences. *DEFINITY Enterprise Communications Server Release 6 — Maintenance for R6vs/si* and *DEFINITY Enterprise Communications Server Release 6 — Maintenance for R6r* discuss these commands and their output in detail.

| Action  | Objects   | Qualifier  |
|---------|---|--|
| display | station<br>data module  | xxxxx (extension)<br>xxxxx (extension)   |
| list    | mmi<br><br>measurements<br><br><br>multimedia   | multimedia-interface<br>voice-conditioner<br>esm<br><br>endpoints ['print' or 'schedule']<br>h.320-stations ['print' or 'schedule']  |
| status  | attendant<br>conference<br>conference<br>conference<br>data module<br>station<br>trunk<br><br>esm | xxxx (console number)<br>all<br>xxx (conference ID)<br>xxx (conference ID) endpoint (endpoint ID)<br>xxxxx (extension)<br>xxxxx (extension)<br>(group number or group number/member number)<br>number) |

## Status commands

The **status** commands for data module, station, trunk, and attendant provide the conference ID and endpoint ID for any of these involved in an active multimedia conference.

```

status station 1002

                                GENERAL STATUS

                                Type: 7405D                Service State: in-service/on-hook
                                Extension: 1002             Maintenance Busy? no
                                Port: 01C0702              SAC Activated? no
                                Call Parked? no             User Cntrl Restr: none
                                Ring Cut Off Act? no        Group Cntrl Restr: none
                                Active Coverage Option: 1    CF Destination Ext:
                                                                MM Conference ID:
                                                                MM Endpoint ID:

Message Waiting:
Connected Ports:

                                ACD STATUS                  HOSPITALITY STATUS
                                Agent Logged In   Work Mode   AWU Call At:
                                                                User DND: not activated
                                                                Group DND: not activated
                                                                Room Status: non-guest room

                                On ACD Call? no
    
```

### Screen 11-30. Status Station 1002 — General Status Form

The following fields specific to multimedia appear on the status station, attendant, data module and trunk screens.

- **MM Conference ID** — This field appears only if the station is active on a multimedia conference. It displays the ID for the conference. Enter this number with the status conference command to get more information about this conference.
- **MM Endpoint ID** — This field appears only if the station is active on a multimedia conference. It displays the endpoint ID for the station. Enter this number with the status conference endpoint command to learn more about this endpoint's involvement in the conference.

## List commands

The **list multimedia endpoints** command shows you all the multimedia data modules that exist in your system, and their associated telephones, if any. The **list multimedia H.320-stations** command shows you all the stations that are administered for H.320 conversion.

11 Multimedia

Enhanced Mode MM complex

| MULTIMEDIA ENDPOINTS |            |           |                   |
|----------------------|------------|-----------|-------------------|
| Data Ext             | MM Complex | Voice Ext | H.320 Conversion? |
| 100                  |            | 87654     | y                 |
| 1321                 |            |           |                   |
| 15683                |            | 738       | n                 |

Screen 11-31. List Multimedia Endpoints Form

| MULTIMEDIA H.320-STATIONS |             |
|---------------------------|-------------|
| Station Ext               | MM Data Ext |
| 100                       | 87654       |
| 1321                      |             |
| 15683                     | 738         |

Screen 11-32. List Multimedia H.320-Stations Form

**List measurements commands**

---

Several reports are available to help you determine the amount of traffic your switch carries for multimedia conferences and conversion calls. All reports show traffic over multimedia circuit packs housed within the same switch, although not necessarily in the same port network. You can use these reports to determine if you have adequate resources to handle the multimedia traffic on your system.

**NOTE:**

Point-to-point multimedia calls between Basic mode or standalone multimedia endpoints do not use MMIs or VCs, and therefore do not count in these measurements.

The following reports are available:

- MMI Hourly and Summary
- ESM-MMI Hourly and Summary
- VC Hourly and Summary

The Hourly and Summary reports provide the same types of information. The hourly report shows measurements for the last 24 hours, whereas the summary reports show measurements for one hour, according to the type of summary you request.



11 Multimedia

Enhanced Mode MM complex

Page 11-91

MMI reports

Use the following commands to view the MMI reports. You can also print or schedule any of these reports.

**list measurements multimedia-interface hourly**

**list measurements multimedia-interface summary yesterday-peak, today-peak, or last-hour**

```
list measurements mmi hourly Page 1
Switch Name: Cust_Switch_Name           Date: 11:33 am TUE JUL 31, 19xx
MMI HOURLY REPORT

Meas Avail Avail Total Total  MMI   Out of %  %
Hour Ports Usage Usage Alloc Denials Srv-CCS APB Blockage
1900 0    0    0    0    0    0    0    0
1800 0    0    0    0    0    0    0    0
1700 0    0    0    0    0    0    0    0
1600 0    0    0    0    0    0    0    0
1500 0    0    0    0    0    0    0    0
1400 0    0    0    0    0    0    0    0
1300 0    0    0    0    0    0    0    0
1200 0    0    0    0    0    0    0    0
1100 0    0    0    0    0    0    0    0
1000 0    0    0    0    0    0    0    0
0900 0    0    0    0    0    0    0    0
0800 0    0    0    0    0    0    0    0
    press CANCEL to quit -- Press NEXT PAGE to continue
```

Screen 11-33. MMI Hourly Report

```
list measurements mmi summary today-peak Page 1
Switch Name: Cust_Switch_Name           Date: 11:33 am TUE JUL 31, 19xx
MMI SUMMARY REPORT

    Peak Hour for all MMIs : 1100

Meas Avail Avail Total Total  MMI   Out of %  %
Hour Ports Usage Usage Alloc Denials Srv-CCS APB Blockage
1100 0    0    0    0    0    0    0    0
```

Screen 11-34. MMI Summary Report

**Table 11-3. MMI Summary Report**

| Field                  | Description   |
|------------------------|---|
| Switch Name            | The name of the switch that contains the MMIs.  |
| Date                   | The date and time that you requested the report, or that the report was run, if scheduled.  |
| Peak Hour For All MMIs | If you use the yesterday-peak or today-peak qualifiers, this field displays the hour of greatest usage for the specified day.   |
| Meas Hour              | The hour for which these measurements apply, on the 24-hour clock.  |
| Avail Ports            | Total network MMI ports in the system. This does not include any MMIs that are cabled to an ESM. ESM-MMIs are measured separately.  |
| Avail Usage            | Total time that is available in the system for network MMI ports, in CCS units.   |
| Total Usage            | The total time, in CCS units, that MMI ports are in use on a call. Includes the time that the ports are out of service or maintenance busy. Usage is measured from the time the port is allocated until it is released.   |
| Total Alloc            | The total number of times that an MMI port was allocated to a call. Keep in mind that a 2-channel call occupies 2 ports, so this number does not necessarily reflect the number of calls that took place. Also, point-to-point calls do not use MMI resources, so these allocations are for conversion calls of multimedia conferences. |
| MMI Denials            | Total number of times an MMI port was needed but could not be allocated because all ports were busy. Ideally, this number should be zero. If you see denials on a regular basis, you should consider adding MMIs to your system.  |
| Out of Srv - CCS       | The total time, in CCS units, that any MMI ports were out of service during any part of the measured interval.  |
| % APB                  | Percent All Ports Busy. The percentage of time during the measured interval that all MMI ports are unavailable to carry a new call.   |
| % Blockage             | The percentage of attempted allocations of MMI ports that are not successful. This value is calculated as % blockage = (MMI Denials / Total Alloc + MMI Denials) * 100  |

11 Multimedia

Enhanced Mode MM complex

Page 11-93

### ESM Reports

Use the following commands to view the ESM reports. You can also print or schedule any of these reports. ESM reports show traffic over the MMI that is cabled to the ESM.

**list measurements esm hourly**

**list measurements esm summary yesterday-peak, today-peak, or last-hour**

```
list measurements esm hourly Page 1
Switch Name: Cust_Switch_Name           Date: 11:33 am TUE JUL 31, 19xx
                ESM HOURLY REPORT

Meas Avail Avail Total Total  MMI   Out of  %   %
Hour Ports Usage Usage Alloc Denials Srv-CCS APB Blockage
1900 0    0    0    0    0    0    0    0
1800 0    0    0    0    0    0    0    0
1700 0    0    0    0    0    0    0    0
1600 0    0    0    0    0    0    0    0
1500 0    0    0    0    0    0    0    0
1400 0    0    0    0    0    0    0    0
1300 0    0    0    0    0    0    0    0
1200 0    0    0    0    0    0    0    0
1100 0    0    0    0    0    0    0    0
1000 0    0    0    0    0    0    0    0
0900 0    0    0    0    0    0    0    0
0800 0    0    0    0    0    0    0    0
      press CANCEL to quit -- Press NEXT PAGE to continue
```

**Screen 11-35. ESM Hourly Report — Page 1**

```
list measurements esm summary today-peak Page 1
Switch Name: Cust_Switch_Name           Date: 11:33 am TUE JUL 31, 19xx
                ESM SUMMARY REPORT

                Peak Hour for all ESM-MMIs : 1100

Meas Avail Avail Total Total  MMI   Out of  %   %
Hour Ports Usage Usage Alloc Denials Srv-CCS APB Blockage
1100 0    0    0    0    0    0    0    0
```

**Screen 11-36. ESM Summary Report**

**Table 11-4. ESM Summary Report**

| Field                      | Description   |
|----------------------------|---|
| Switch Name                | The name of the switch that contains the ESM-MMIs.  |
| Date                       | The date and time that you requested the report, or that the report was run, if scheduled.  |
| Peak Hour For All ESM-MMIs | If you use the yesterday-peak or today-peak qualifiers, this field displays the hour of greatest usage for the specified day.   |
| Meas Hour                  | The hour for which these measurements apply, on the 24-hour clock.  |
| Avail Ports                | Total network ESM-MMIs in the system.   |
| Avail Usage                | Total time, in CCS units, that is available in the system for ESM-MMI ports.  |
| Total Usage                | The total time, in CCS units, that ESM-MMI ports are in use on a call. Includes the time that the ports are out of service or maintenance busy. Usage is measured from the time the port is allocated until it is released. |
| Total Alloc                | The total number of times that an ESM-MMI port was allocated to a call.   |
| MMI Denials                | Total number of times an ESM-MMI port was needed but could not be allocated because all ports were busy.  |
| Out Srv                    | The total time, in CCS units, that any ESM-MMI ports were out of service during any part of the measured interval.  |
| %APB (all ports busy)      | The percentage of time during the measured interval that all ESM-MMI ports are unavailable to carry a new call.   |
| % Blockage                 | The percentage of attempted allocations of ESM-MMI ports that are not successful. This value is calculated as % blockage = (MMI Denials / Total Alloc + MMI Denials) * 100  |

## VC reports

Use the following commands to view the MMI reports. You can also print or schedule any of these reports.

### **list measurements voice-conditioners hourly**

11 Multimedia

Enhanced Mode MM complex

Page 11-95

**list measurements voice-conditioners summary yesterday-peak,  
 today-peak, or last-hour**

```
list measurements esm hourly                                     Page 1
Switch Name: Cust_Switch_Name                               Date: 11:33 am TUE JUL 31, 19xx
VC HOURLY REPORT

Meas # -----USAGE----- --ALLOCATIONS--- -----DENIALS----- Out % %
Hour Prt Avail H320 Voice Total H320 Voice Total H320 Voice Total Srv APB Blk
1900 0 0 0 0 0 0 0 0 0 0 0 0 0 0 0
1800 0 0 0 0 0 0 0 0 0 0 0 0 0 0 0
1700 0 0 0 0 0 0 0 0 0 0 0 0 0 0 0
1600 0 0 0 0 0 0 0 0 0 0 0 0 0 0 0
1500 0 0 0 0 0 0 0 0 0 0 0 0 0 0 0
1400 0 0 0 0 0 0 0 0 0 0 0 0 0 0 0
1300 0 0 0 0 0 0 0 0 0 0 0 0 0 0 0
1200 0 0 0 0 0 0 0 0 0 0 0 0 0 0 0
1100 0 0 0 0 0 0 0 0 0 0 0 0 0 0 0
1000 0 0 0 0 0 0 0 0 0 0 0 0 0 0 0
0900 0 0 0 0 0 0 0 0 0 0 0 0 0 0 0
0800 0 0 0 0 0 0 0 0 0 0 0 0 0 0 0
press CANCEL to quit -- Press NEXT PAGE to continue
```

**Screen 11-37. ESM Hourly Report — Page 1**

```
list measurements vc summary today-peak                       Page 1
Switch Name: Cust_Switch_Name                               Date: 11:33 am TUE JUL 31, 19xx
VOICE-COndITIONERS SUMMARY REPORT
Peak Hour for all VC : 1100

Meas # -----USAGE----- --ALLOCATIONS--- -----DENIALS----- Out % %
Hour Prt Avail H320 Voice Total H320 Voice Total H320 Voice Total Srv APB Blk
1100 0 0 0 0 0 0 0 0 0 0 0 0 0 0 0
```

**Screen 11-38. VC Summary Report**

**Table 11-5. VC Summary**

| Field                | Description  |
|----------------------|--|
| Switch Name          | The name of the switch that contains the VCs.  |
| Date                 | The date and time that you requested the report, or that the report was run, if scheduled.   |
| Peak Hour For All VC | If you use the yesterday-peak or today-peak qualifiers, this field displays the hour of greatest usage for the specified day.  |
| Meas Hour            | The hour for which these measurements apply, on the 24-hour clock.   |
| # Prt                | Total number of VC ports in the system.  |
| Usage - Avail        | Total time, in CCS, that all VC ports are available in the system. Calculated as #MMI ports x 36.  |
| Usage - H320         | Total time that VC ports are allocated to H320 endpoints.  |
| Usage - Voice        | Total time VC ports are allocated to voice endpoints.  |
| Usage -Total         | Total time, in CCS units, that VC ports are unavailable to carry a new call. This includes time that the ports are busy on a call, out of service or maintenance busy. Measured from the time that the port is allocated until it is released. |
| Allocation s - Total | Total number of times a VC port was allocated to a call. Each B-channel used on a multimedia call counts as one allocation.  |
| Denials-H320         | Number of times a port was needed for an H320 call, but was not available.   |
| Denials -voice       | Number of times a port was needed for a voice call, but was not available.   |
| Denials-To tal       | Total number of times a VC port was needed for any call, but was not allocated because all VC ports were busy.   |

*Continued on next page*

**Table 11-5. VC Summary**

| Field                 | Description  |
|-----------------------|--|
| Out Srv               | The total time, in CCS units, that any MMI ports were out of service during any part of the measured interval.   |
| %APB (all ports busy) | The percentage of time during the measured interval that all MMI ports are unavailable to carry a new call.  |
| % Blockage            | The percentage of attempted allocations of MMI ports that are not successful. This value is calculated as % blockage = (MMI Denials / Total Alloc + MMI Denials) * 100 |

## Considerations

Each channel of a 2-channel BRI call takes one port on an MMI circuit pack. This alone limits the number of multimedia calls your system can handle. In addition, each conference takes one port on a voice-conditioner circuit pack.

Also, there is a limit to the number of conversion calls that the system can handle simultaneously. If you experience traffic problems after installing multimedia, you may want to lower the number of stations that use H.320 conversion.

## References

---

Other information about MMCH is available in the following books:

*DEFINITY ECS Release 6 — Overview* contains a high-level description of the MMCH feature.

*DEFINITY ECS Release 6 — Installation for Adjuncts and Peripherals* describes how to install necessary circuit packs, and how to set up endpoint hardware and software.

*DEFINITY ECS Release 6 — Maintenance*

*DEFINITY ECS Release 6 — System Description Pocket Reference* describes the hardware components that are required for MMCH.



## Private Networking

# 12

This section contains the following DEFINITY ECS Private Networking features and related forms.

**Table 12-1. Private Networking features and related forms**

| <b>Feature</b>                                | <b>Page</b>           |
|---|-----------------------|
| ATM-PNC                                       | <a href="#">12-3</a>  |
| Centralized Attendant Service                 | <a href="#">12-4</a>  |
| Distributed Communications System             | <a href="#">12-11</a> |
| DCS Alphanumeric Display for Terminals        | <a href="#">12-27</a> |
| DCS Attendant Control of Trunk Group Access   | <a href="#">12-28</a> |
| DCS Attendant Direct Trunk Group Selection    | <a href="#">12-29</a> |
| DCS Attendant Display                         | <a href="#">12-31</a> |
| DCS Automatic Callback                        | <a href="#">12-32</a> |
| DCS Automatic Circuit Assurance               | <a href="#">12-34</a> |
| DCS Busy Verification of Terminals and Trunks | <a href="#">12-35</a> |
| DCS Call Coverage                             | <a href="#">12-36</a> |
| DCS Call Forwarding                           | <a href="#">12-41</a> |
| DCS Call Waiting                              | <a href="#">12-42</a> |

*Continued on next page*

**Table 12-1. Private Networking features and related forms**  
 — *Continued*

| <b>Feature</b>                               | <b>Page</b>            |
|--|------------------------|
| DCS Distinctive Ringing                      | <a href="#">12-43</a>  |
| DCS Leave Word Calling                       | <a href="#">12-44</a>  |
| DCS Multiappearance Conference/Transfer      | <a href="#">12-46</a>  |
| DCS Over ISDN-PRI D-channel                  | <a href="#">12-47</a>  |
| DCS Trunk Group Busy/Warning Indication      | <a href="#">12-52</a>  |
| DCS with Rerouting                           | <a href="#">12-50</a>  |
| Emergency (911) Calls                        | <a href="#">12-54</a>  |
| Enhanced DCS                                 | <a href="#">12-55</a>  |
| Extended Trunk Access                        | <a href="#">12-67</a>  |
| Extension Number Portability                 | <a href="#">12-70</a>  |
| Inter-PBX Attendant Calls                    | <a href="#">12-72</a>  |
| Node Number Routing                          | <a href="#">12-74</a>  |
| Private Network Access                       | <a href="#">12-75</a>  |
| QSIG   | <a href="#">12-77</a>  |
| QSIG Call Forwarding (Diversion)             | <a href="#">12-82</a>  |
| QSIG Call Transfer                           | <a href="#">12-84</a>  |
| QSIG Name and Number Identification          | <a href="#">12-86</a>  |
| QSIG Path Replacement (ANF-PR)               | <a href="#">12-90</a>  |
| QSIG Supplementary Service - Call Completion | <a href="#">12-91</a>  |
| QSIG Supplementary Service - Call Offer      | <a href="#">12-96</a>  |
| QSIG Transit Counter (ANF-TC)                | <a href="#">12-99</a>  |
| Uniform Dial Plan                            | <a href="#">12-103</a> |
| <hr/>  |                        |
| <b>Form</b>                                  | <b>Page</b>            |
| Private Networking Forms                     | <a href="#">12-109</a> |

## ATM-PNC

---

Port network connectivity (PNC) enables you to connect the processor port network (PPN) to each of the expansion port networks (EPNs). The ATM-PNC feature uses an asynchronous transfer mode (ATM) switch to perform the function of the center-stage switch between the PPN and EPNs.

---

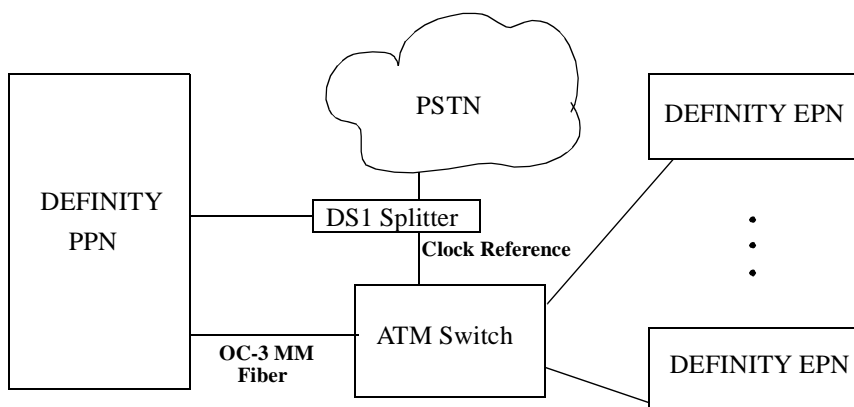

---

**Figure 12-1. ATM-PNC Hardware Configuration**

### How to Administer ATM-PNC

---

The initial administration of an ATM-PNC system is performed by service technicians at installation. See *Installation for Adjuncts and Peripherals* for details. For a description of maintenance procedures including troubleshooting for ATM-PNC, see *Maintenance for R6r*, 555-230-126, Issue 3.

## Centralized Attendant Service

---

### Required forms

| Form                                     | Field  | Page                  |
|--|--|-----------------------|
| System-Parameters<br>Customer-Options    | Async. Transfer Mode (ATM)<br>PNC?                             | <a href="#">5-277</a> |
| Synchronization Plan                     | Synchronization Source<br>Synchronization Reference<br>Stratum |                       |
| Duplication-Related System<br>Parameters | Enable Operation of PNC<br>Duplication                         | <a href="#">5-104</a> |
| Fiber Link Administration                |  |                       |
| ATM-PNC                                  | All  |                       |
| Circuit Packs                            |  |                       |
| Cabinet                                  |  |                       |

Centralized Attendant Service (CAS) allows attendants in a private network of switching systems to be concentrated at a central or main location.

## How to administer CAS

---

### Required forms

| Form                       | Field   | Page                  |
|----------------------------|---|-----------------------|
| Attendant Console          | <ul style="list-style-type: none"> <li>■ Feature Button Assignments</li> <li>— cas-backup -trunk-name</li> </ul>  | <a href="#">5-35</a>  |
| Console-Parameters         | <ul style="list-style-type: none"> <li>■ CAS</li> <li>■ RLT Trunk Group Number</li> <li>■ CAS Back-Up Ext</li> <li>■ Timed Reminder on Hold</li> <li>■ Return Call Timeout (sec)</li> </ul> | <a href="#">5-86</a>  |
| Station (multi-appearance) | <ul style="list-style-type: none"> <li>■ Feature Button Assignments</li> <li>— cas-backup</li> <li>— flash</li> <li>— trunk name</li> <li>— night serv</li> </ul>                           | <a href="#">6-28</a>  |
| Trunk Group (RLT)          | <ul style="list-style-type: none"> <li>■ All</li> </ul>   | <a href="#">7-252</a> |
| Feature Access Code (FAC)  | <ul style="list-style-type: none"> <li>■ CAS Remote Hold Access Code</li> </ul>   | <a href="#">5-113</a> |

## Detailed description

Each branch in a CAS has its own LDN or other type of access from the public network. Incoming trunk calls to the branch, as well as attendant-seeking voice terminal calls, route to the centralized attendants over release link trunks (RLT).

The CAS attendants are at the main location. The main location can be a DEFINITY ECS, a DEFINITY System Generic 1 or 3, a DEFINITY System Generic 2.1, a System 85, a DIMENSION PBX, or a System 75 (V3).

The CAS main switch operates independently of the CAS branch switches. Operation for CAS main-switch traffic is identical to operation of a stand-alone switch.

Each branch in a CAS network connects to the main by way of RLTs. These trunks provide paths for:

- Sending incoming attendant-seeking trunk calls at the branch to the main for processing and extending them back to the branch (both parts of a call use the same trunk)
- Returning timed-out waiting and held calls from the branch to the main
- Routing calls from the branch to the main

Two queues are associated with CAS calls: one at the main and one at the branch. If idle RLTs are available from the branch to the main, RLTs are seized and CAS calls are queued at the main along with other attendant-seeking calls. If all RLTs are in use, CAS calls to the attendant are queued at the branch in a RLT queue. The length of the queue can vary from 1 to 100, as set during administration of the RLT group.

Backup service provides for all CAS calls can be sent to a backup extension in the branch if all RLTs are maintenance-busy or out of service, or if the attendant presses a Backup button that is not lighted.

- To activate the feature and provide notification that backup service is in effect, assign the backup extension to a Backup button and associated status lamp.
- The status lamp remains lighted as long as backup service is in effect.
- To deactivate the feature, the attendant presses the Backup button while the status lamp is lighted. Calls are not sent to the backup extension unless all RLTs are maintenance-busy or out of service.

The attendant can put a CAS call from a branch on Remote Hold. The branch holds the call and drops the RLT. After a time-out (same as the timed reminder for an attendant-held call), the branch automatically attempts to route the call back to the attendant. The returning call can queue for the RLT. Attendants should use Remote Hold when they have to put a call on hold to keep RLTs from being tied up unnecessarily.

## Branch-generated call-identification tones

The branch in a CAS network generates call-identification tones and transmits them to the CAS attendant by way of the RLT. These tones indicate the type of call coming from the branch or the status of a call extended to or held at the branch. The attendant hears these tones in the console handset before being connected to the caller. The tones may vary by country.

- Incoming trunk call: 480 Hz (100 ms), 440 Hz (100 ms), 480 Hz (100 ms) in sequence; heard immediately after attendant lifts handset
- Call from branch terminal to attendant or transferred by branch terminal to attendant: 440 Hz (100 ms), silence (100 ms), 440 Hz (100 ms) in sequence; heard immediately after attendant lifts handset
- Call extended to idle station or recall on does not answer ringback tone (300 ms) followed by connection to normal ringing cycle
- Call extended to busy terminal — automatically waiting or recall on attendant call waiting: 440 Hz (100 ms)
- Call extended to busy terminal — waiting denied or not provided: busy tone
- Remote hold or remote hold recall: a series of four to six cycles of 440 Hz (50 ms), silence (50 ms)
- Recall on does not answer: burst of ringback (300 ms), then connection to normal ringback at any point in its cycle
- Recall from a call on remote hold: a series of four to six cycles of 440 Hz (50 ms), silence (50 ms)
- Recall from a call waiting at a single-line terminal: burst of 440 Hz (100ms)

The centralized attendant at the main has access, through RLTs, to all outgoing trunk facilities at the branches in a CAS network. The attendant can extend an incoming LDN call to an outgoing trunk at a branch by dialing the access code and allowing the caller to dial the rest of the number or by dialing the complete outgoing number.

Calls extended to busy single-line voice terminals at the branch wait automatically. If there is a call in queue, the user hears a busy signal. When station hunting and send all calls is administered, the call routes along the administered path. Not answering any waiting extended call within an administered interval causes the branch switch to return the call to the attendant. Call Waiting does not apply to multiappearance terminals; if no appearances are available, busy tone is sent to the attendant, who tells the caller that the line is busy.

Calls from voice terminals at the branch to an attendant also route over RLTs seized by the branch switch. A branch caller reaches the attendant by dialing the attendant-group access code. The access code is administrable; the default is 0. The conversation between the branch caller and the attendant ties up the seized RLT, but calls of this type are usually short.

## Considerations

---

- CAS reduces the number of attendants required at a branch. For example, a chain of department stores can have a centralized attendant location at the main store to handle calls for the branch stores.
- In a CAS network, DEFINITY switches can function as branches or as the main. A branch can connect to only one main.
- A branch can have an attendant. Access to the branch attendant must be by way of an individual attendant extension. Incoming trunk calls in a CAS network can bypass branch attendants but can be routed back to them by the centralized attendant.
- Branch calls terminate on the CAS main switch based on the incoming RLT trunk-group day-destination or night-service destination. An attendant console is not always answering or extending incoming CAS calls. If someone other than an attendant answers a CAS call, that person can extend the call back to the branch by pressing the FLASH button on a multiappearance voice terminal or flashing the switchhook on a single-line voice terminal. The branch reaction to Flash Signals and the branch application of tones is the same whether an attendant or someone other than an attendant answers or extends the call.
- If an extended call returns to the main attendant unanswered, the called party at the branch does not drop but continues to be alerted until the caller releases. This allows the attendant to talk to the caller, then extend the call again, if the caller wishes, without redialing the number.
- If an extended CAS call recall times out and goes to coverage but no one answers, then the branch leaves the extended-to party ringing and drops coverage.
- When an analog-station call goes to coverage, the station drops from the call. This is the exception to the branch leaving the extended-to party ringing. If the main attendant extends a call to an analog station and that call goes to coverage and later returns to the main attendant, the call is treated as an incoming LDN call and the attendant must re-extend the call, if requested by the user.
- On an incoming CAS call to the main attendant, the Name field from the trunk-group form for that RLT displays to the attendant. Therefore, you should administer the field to provide meaningful branch identification information.
- Music-on-Hold feature at branch applies to two stages of LDN calls: during call extension and Remote Hold.

## Interactions

---

- Abbreviated Dialing

## 12 Private Networking

### Centralized Attendant Service

Page 12-8

The main attendant can use an Abbreviated Dialing button to extend CAS calls after obtaining branch dial tone.

- Attendant Auto-Manual Splitting

The SPLIT lamp and button do not function on CAS main calls extended via the RLT trunk. Attendant conference does not function on CAS calls.

- Attendant Control of Trunk-Group Access

If a branch attendant has control of an outgoing RLT trunk group, new attendant-seeking calls route to the branch attendant.

- Attendant Override of Diversion

Use Attendant Override of Diversion with CAS.

- Attendant Serial Calling

Attendant Serial Calling does not work for CAS calls.

- Automatic Alternate Routing and Automatic Route Selection

CAS calls can be routed using AAR and ARS.

- Busy-Indicator Buttons

Busy indicators can identify incoming calls over an RLT. You can also use Busy indicators to dial after the attendant starts to extend a call.

- Call Coverage

Redirect calls to a centralized attendant by Call Coverage. Do not redirect calls to a CAS backup extension for backup service via Send All Calls to the backup extension's coverage path.

- Call Detail Recording

If the CAS main RLT trunk has the CDR option selected, CDR records generate for incoming CAS calls.

- Call Forwarding

Do not forward calls to a CAS extension.

- Call Park

If a CAS attendant parks a call and the call returns to the attendant after the Call Park expiration interval, the attendant hears incoming trunk-call notification.

- DCS Operation

If an RLT trunk group is administered as a DCS trunk, the following interaction applies: On an incoming CAS call to the attendant, the DCS message displays instead of the name of the incoming RLT trunk group. Upon answering the call, the attendant hears call-identification tones, indicating that the call is a CAS call. Use a TRUNK-NAME button to obtain the name of the RLT trunk group.

- DXS and DTGS Buttons



## 12 Private Networking

### Centralized Attendant Service

Page 12-9

DXS and DTGS buttons at the main attendant console can be used with CAS. However, with DXS buttons, it takes a few seconds before the attendant hears ringback tone.

- Emergency Access to the Attendant

CAS Branch Emergency Access calls generated by a Feature Access Code route Off-Hook Alert to the branch attendant group. If there is no attendant in the branch, the call routes to the branch's administered Emergency Access Redirection Extension. When the branch switch is in CAS Backup Service, the calls route to the backup station and the call is treated as a normal call.

- Hunt Groups

If an incoming CAS call directs to a hunt group, the call does not redirect to the hunt group's coverage path. Depending on the circumstances, the attendant can get a busy tone or ringing.

- Last Number Dialed

An attendant cannot extend calls using Last Number Dialed.

- Leave Word Calling

If a message is left for a branch user and the attendant at the CAS switch tries to retrieve the message by using LWC message retrieval, permission is denied.

- Night Service — Night Console Service

When the CAS main enters night service, CAS calls terminate at the CAS main night-service destination. When the branch enters Night Service, CAS calls route to the branch night console, the LDN night station, or the TAAS.

- Night Service — Trunk Answer from Any Station

In a multiswitch DCS environment with CAS, the result of transferring incoming trunk calls via Night Service Extension or Trunk Answer from Any Station varies depending on the home switch of the transferred-to station, the home switch of the connected trunk, and the type of night-service function chosen (Night Service Extension, Trunk Answer From Any Station, or both).

- Nonattendant Console Handling of CAS Calls

The CAS branch calls terminate at the CAS main based on the incoming RLT trunk-group day destination or night-service destination. You can also answer a CAS call by the Trunk Answer Any Station feature.

Normally, a nonattendant extends a CAS call by pressing the Flash button. However, if the nonattendant does not have a Flash button, extend the call as follows:

## 12 Private Networking

### Centralized Attendant Service

Page 12-10

- Multiappearance voice-terminal users press the Conference or Transfer button and then dial the desired extension. To complete the call, the user drops the call. To drop the extended-to party, the user presses the Conference or Transfer button again.
- Single-line voice-terminal users flash the switchhook and then dial the extension. To complete the call, the user drops the call. To drop the extended-to party, the user flashes the switchhook again.
- **Non-Attendant Console Holds Call**

A multifunction nonattendant can hold a CAS call by pressing the hold button.
- **Nonattendant Console Releases Call**

A nonattendant can drop the RLT by going on-hook, using the DISCONNECT or DROP button, or selecting another call appearance.
- **Nonattendant — Display Trunk Name**

If the nonattendant with a display presses the TRUNK-NAME button while active on a trunk call, the switch displays *Name* from the trunk-group form.
- **Timed Reminder**

The timer value for recalling held calls at the attendant console that can be set on the console form.

If an attendant at the CAS main transfers a call from a branch to an extension at the main, the timed reminder does not apply and the call does not return to the attendant if unanswered. If a branch call is unanswered, the branch timed reminder times out and the call routes to a new RLT trunk and back to a CAS main attendant.
- **Trunk-Name Button**

Use the trunk-name button when an outgoing call is made over a trunk administered to have no outgoing display.

## Distributed Communications System

---

Distributed Communications System (DCS) allows you to configure 2 or more switches as if they were a single, large DEFINITY ECS. DCS provides attendant and voice-terminal features between these switch locations. DCS simplifies dialing procedures and allows transparent use of some of the DEFINITY ECS features. (Feature transparency means that features are available to all users on DCS regardless of the switch location.)

Configuring a DCS network is a complex process that involves 4 major steps:

- Planning your DCS network
- Connecting the physical equipment in the network
- Administering the physical layer (hardware connections)
- Administering the link layer to create a DCS

### How to administer DCS

---

To administer your DCS, complete the following steps:

1. Connect the switches using the necessary circuit packs, data modules, and boards, and trunks.

For more information about what hardware you need for your physical DCS network and how to connect the network, see *DEFINITY Enterprise Communications Server Release 6 Terminals and Adjuncts Reference*.

2. Administer any packet gateway (pgate) boards, processor data modules (PDM), X.25 data modules, processor interface data modules, and trunks you have in the DCS network.



**NOTE:**

Trunk group member numbers and trunk group numbers must match on both ends of each connection.

For information about administering this equipment, see the following sections in this book.

| Form   | Page                  |
|--|-----------------------|
| DS1 Circuit Pack   | <a href="#">7-79</a>  |
| Trunk Groups   | <a href="#">7-115</a> |
| Data Modules   | <a href="#">6-226</a> |
| X.25 (R5r and later configurations only)                 | <a href="#">6-249</a> |
| Processor Interface (R5si and later configurations only) | <a href="#">6-246</a> |
| Netcon (R5si and later configurations only)              | <a href="#">6-245</a> |
| Processor (if both R5si and R5r in the DCS)              | <a href="#">6-243</a> |
| Packet Gateway Board (R5r and later configurations only) | <a href="#">5-246</a> |

- Plan and implement a Dial Plan and Uniform Dial Plan for each switch in the DCS network.

For more information about administering the dial plans, see [“Dial Plan” on page 4-311](#) and [“Uniform Dial Plan” on page 12-103](#).

Plan your network so you can easily expand and administer the dial plan table. All nodes within the DCS network must be assigned compatible but different dial plans. It is recommended that:

- All feature access codes be identical
- Design routing patterns consistently at each node to make outward dialing transparent

Use the Uniform Dial Plan (UDP) to assign extensions. The UDP design has to be coordinated among the switches in the DCS network to obtain a common 4- or 5-digit dial plan. For example, if you have three switches (nodes) in your DCS network, plan to use unique groups of extensions for each switch (such as, 4xxx on one switch, 5xxx on the second switch, and 6xxx on the third switch).

 **NOTE:**

Be sure to record the value in `Local PBX ID` for each switch. You need to use this ID to identify the node number on the Route Pattern form.

The Local PBX ID is the value assigned to the nearest switch (node). For example, if switch A is connected to B, the Local PBX ID at A identifies the node number for B. Similarly, you can find the node number for A, by looking for the Local PBX ID on B (be sure to look at the connection to A, if it has more than one connection).

4. Complete a route pattern for each ultimate destination in the network.

For example, if you have four switches in your DCS — switches A, B, C, and D — you need route patterns for each of the following connections:

|        |        |        |        |
|--------|--------|--------|--------|
| A to B | A to C | A to D | B to C |
| B to D | C to D | B to A | C to A |
| D to A | C to B | D to B | D to C |

5. Administer the following forms to configure the links in the DCS:



**NOTE:**

Complete the Administered Connections form if you use a PDM and you set the Destination (or Destination Number for R5r and later configurations) to external on the Interface Links form.

**Required forms**

| Form            | Field   | Page                  |
|-----------------|---|-----------------------|
| Interface Links | ■ Enable  | <a href="#">5-179</a> |
|                 | ■ X.25 Connection<br>(R5r and later configurations)       |                       |
|                 | ■ Destination Number<br>(R5r and later configurations)    |                       |
|                 | ■ Establish Connection<br>(R5r and later configurations)  |                       |
|                 | ■ Connected Data Module<br>(R5r and later configurations) |                       |
|                 | ■ Est Conn<br>(R5si and later configurations)             |                       |
|                 | ■ PI Ext<br>(R5si and later configurations)               |                       |
|                 | ■ Prot<br>(R5si and later configurations)                 |                       |
|                 | ■ Destination<br>(R5si and later configurations)          |                       |
|                 | ■ DCE/DTE<br>(R5si and later configurations)              |                       |

### Required forms

| Form                         | Field   | Page   |
|------------------------------|---|--|
| Administered Connection      | ■ Connection Number                                     | <a href="#">5-17</a>                                     |
|                              | ■ Originator  |  |
|                              | ■ Destination   |  |
|                              | ■ Name  |  |
|                              | ■ Retry Interval  |  |
|                              | ■ Auto Restoration?                                     |  |
| Processor Channel Assignment | ■ All Proc Chan fields that you want to be assigned DCS | <a href="#">5-248</a><br>(R5r and later configurations)  |
|                              |   | <a href="#">5-252</a><br>(R5si and later configurations) |

- Complete the Processor Channel Assignment form on each switch to establish dialogs from the switch to other nodes on the network.

This step involves extensive planning as you must map each link, channel, and remote port throughout the network.

- Administer the Hop Channels.

For more information, see [“Hop Channel Assignments Form” on page 12-116](#).

- If you are using ISDN, administer the gateway functions.

For more information, see [“ISDN TSC Gateway Channel Assignments” on page 7-98](#).

### Detailed description of DCS

DCS network configurations can be:

- Traditional DCS network — A DCS network configured with 2 or more switches using BX.25 signaling for transporting DCS feature transparency information.
- D-channel DCS network (private network only) — A DCS network that includes DEFINITY ECS using the ISDN-PRI D-channel DCS transparency information (D-channel signaling). ISDN-PRI facilities with this type of network use only private-line facilities.
- D-channel DCS network (public network access/egress) — A DCS network that includes DEFINITY ECS using D-channel signaling. At least one of these ISDN-PRI facilities uses a public network ISDN-PRI.

## **12 Private Networking**

### *Distributed Communications System*

*Page 12-15*

- Integrated DCS network (private network only) — A DCS network that contains a variety of switches using BX.25 or D-channel signaling methods. At least one DEFINITY ECS serves as an ISDN-PRI DCS Gateway node. This node can interwork DCS transparency information between a BX.25 connection and one of the ISDN-PRI user-to-user signaling methods over the D-channel.  
  
An ISDN-PRI DCS Gateway node provides backward compatibility to existing traditional DCS networks.
- Integrated DCS network (public network access) — The same as D-channel DCS Network (Private Network Only), but the D-channel of at least one ISDN- PRI facility uses a public network ISDN-PRI.

Once you have connected and set up your DCS network, you can provide the following features across the network:

- DCS Alphanumeric Display for Terminals
- DCS Attendant Control of Trunk Group Access
- DCS Attendant Direct Trunk Group Selection
- DCS Attendant Display
- DCS Automatic Callback
- DCS Automatic Circuit Assurance
- DCS Busy Verification of Terminals and Trunks
- DCS Call Coverage
- DCS Call Forwarding
- DCS Call Waiting
- DCS Distinctive Ringing
- DCS Leave Word Calling
- DCS Multiappearance Conference/ Transfer
- DCS Over ISDN-PRI D-channel
- DCS Trunk Group Busy/Warning Indication
- DCS with Rerouting
- Enhanced DCS

### **DCS/AUDIX gateway**

DEFINITY ECS can serve as an interface between PBXs that support the D-channel signaling feature and those that do not support this feature. The switch providing this interface is known as the ISDN-DCS Gateway node and provides backward compatibility to existing traditional DCS networks.

It maintains a mapping between processor channels and Administered NCA-TSCs. When a DCS D-channel message arrives on an Administered NCA-TSC acting as a gateway, it is converted to a traditional DCS message and sent out through the processor channel that has been administered to map to this Administered NCA-TSC. Likewise, when a traditional DCS message arrives at the gateway node on a processor channel acting as a gateway, it is converted to a DCS D-channel message and sent out through the Administered NCA-TSC that has been associated with this processor channel on the ISDN Gateway Channel form.

In summary, a gateway is required whenever a transition is being made from BX.25 signaling to D-channel signaling. When the transition takes place at a switch that sits between that part of the network that supports D-channel DCS and that part that does not, that switch is an ISDN-DCS Gateway. A DCS network consisting entirely of switches that support D-channel DCS never requires an ISDN-DCS Gateway because none of the switches require "translation" to/from BX.25.

## Example DCS configurations

The following two examples provide details for setting up two basic DCS networks. The first is a two-node network and the second is a three-node network.

### 2-Node private network with AUDIX

[Figure 12-2](#) shows a 2-node DCS/AUDIX D-channel network. In this configuration, DCS feature transparency is achieved exclusively through the exchange of user-to-user information on the D-channel using one of the three methods discussed earlier — MA-UUI, CA-TSCs or NCA-TSCs. Although NCA-TSCs are nothing more than virtual connections on the D-channel, they are shown as independent entities in the diagram for the purposes of clarity. Administered TSC 2/1 (that is, the first Administered NCA-TSC of signaling group 2) of Switch A is connected to TSC 4/1 of Switch B. This virtual connection is used in the exchange of user-to-user information for DCS features not associated with any current B-channel connection.

Notice that for AUDIX, a BX.25 data link is no longer required between the host switch and the remote switch(es). AUDIX messages between the AUDIX and the remote switch will use the AUDIX Gateway functionality of the host switch and will be transported to the remote switch via an NCA-TSC. Specifically, AUDIX messages destined for Switch B will arrive at Switch A on Link 1, Channel 2 (processor channel 57), be converted to ISDN-PRI Q.931 format and sent out via Administered NCA-TSC 2/2.

This is accomplished by administering processor channel 57 as a gateway and mapping it on the gateway form to Administered NCA-TSC 2 of signaling group 2 that is also administered as a gateway.



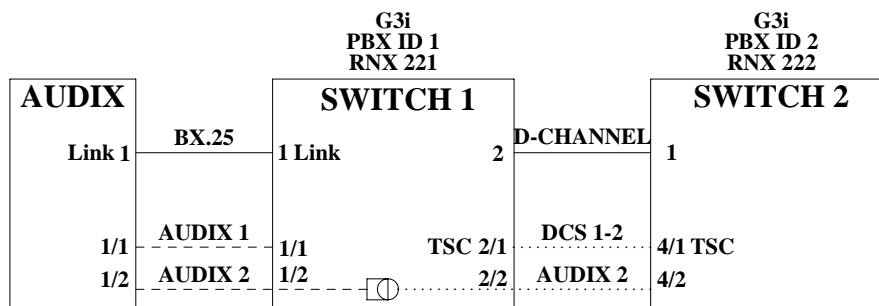

Figure 12-2. 2-Node private network

The following tables show you how you would complete each of the necessary forms.

### AUDIX administration

- AUDIX Translations for,

| Switch Number | AUDIX Port | Switch Port <sup>1</sup> | Logical Channel | Data Link |
|---------------|------------|--------------------------|-----------------|-----------|
| 1             | 1          | 59                       | 1               | 1         |
| 2             | 2          | 57                       | 2               | 1         |

1. Switch Port refers to the processor channel that is used for AUDIX in the PBX.

### Administration for switch 1

- Dial Plan form

| Start Dig. | Len | Usage |
|------------|-----|-------|
| 4          | 4   | ext   |
| 5          | 4   | ext   |

- Uniform Dial Plan form

| Ext Code | Type    | Location Code |
|----------|---------|---------------|
| 5xxx     | UDPcode | 222           |

12 Private Networking

Distributed Communications System

■ AAR Digit Conversion form

| Matching Pattern | Min | Max | Del | Replacement String | Net | Conv |
|------------------|-----|-----|-----|--------------------|-----|------|
| 221              | 7   | 7   | 3   | -                  | ext | n    |

■ AAR Analysis Table

| Dialed String | Min | Max | Rte Pat | Call Type | Node Num |
|---------------|-----|-----|---------|-----------|----------|
| 222           | 7   | 7   | 2       | aar       | 2        |

■ Signaling Group form (signaling group 2)

| TSC   | Local | Enabled | Establish | Dest. | Far-end | Appl.   |
|-------|-------|---------|-----------|-------|---------|---------|
| Index | Ext.  |         |           | Ext.  | PBX-ID  |         |
| 1     | 4900  | y       | permanent | 5900  | 2       | dcs     |
| 2     | 4901  | y       | permanent | 5901  | -       | gateway |

■ Trunk Group form

| Group # | Grp Type | Used for DCS? | DCS Sig. Method | PBX ID |
|---------|----------|---------------|-----------------|--------|
| 2       | isdn-pri | y             | d-chan          | 2      |

■ Routing Pattern form

| Routing Pattern # | Trunk Group # | FRL | Del | TSC | CA-TSC Request |
|-------------------|---------------|-----|-----|-----|----------------|
| 2                 | 2             | 0   | 3   | y   | at-setup       |

■ Gateway Channel form

| Signaling Group | TSC Index | Processor Channel | Application |
|-----------------|-----------|-------------------|-------------|
| 2               | 2         | 57                | audix       |

12 Private Networking

Distributed Communications System

- Processor Channel form

| Proc Channel | Application | Inter. Link | Channel | Remote Proc. Channel | PBX ID |
|--------------|-------------|-------------|---------|----------------------|--------|
| 57           | gateway     | 1           | 2       | 2                    | -      |
| 59           | audix       | 1           | 1       | 1                    | 1      |

Administration for switch 2

- Dial Plan form

| Start Dig. | Len | Usage |
|------------|-----|-------|
| 4          | 4   | ext   |
| 5          | 4   | ext   |

- Uniform Dial Plan form

| Ext Code | Type    | Location Code |
|----------|---------|---------------|
| 4xxx     | UDPcode | 221           |

- AAR Digit Conversion form

| Matching Pattern | Min | Max | Del | Replacement String | Net | Conv |
|------------------|-----|-----|-----|--------------------|-----|------|
| 222              | 7   | 7   | 3   | -                  | ext | n    |

- AAR Analysis Table

| Dialed String | Min | Max | Rte Pat | Call Type | Node Num |
|---------------|-----|-----|---------|-----------|----------|
| 221           | 7   | 7   | 1       | aar       | 1        |

- Signaling Group form (signaling group 4)

| TSC Index | Local Ext. | Enabled | Establish | Dest. | Far-end Ext. | Appl PBX-ID |
|-----------|------------|---------|-----------|-------|--------------|-------------|
| 1         | 5900       | y       | permanent | 4900  | 1            | dcs         |
| 2         | 5901       | y       | permanent | 4901  | -            | audix       |

12 Private Networking

Distributed Communications System

- Trunk Group form

| Group # | Grp Type | Used for DCS? | DCS Sig. Method | PBX ID |
|---------|----------|---------------|-----------------|--------|
| 1       | isdn-pri | y             | d-chan          | 1      |

- Routing Pattern form

| Routing Pattern # | Trunk Group # | FRL | Del | TSC | CA-TSC Request |
|-------------------|---------------|-----|-----|-----|----------------|
| 1                 | 1             | 0   | 3   | y   | at-setup       |

### 3-Node public/private network with AUDIX

The D-channel signaling feature expands the domain of DCS networks by supporting configurations that include public network ISDN facilities utilizing network services including Software Defined Network (SDN). By eliminating the need for dedicated private line facilities, this feature allows geographically dispersed DCS networks to be cost effective. [Figure 12-3](#) shows a 3-node network.

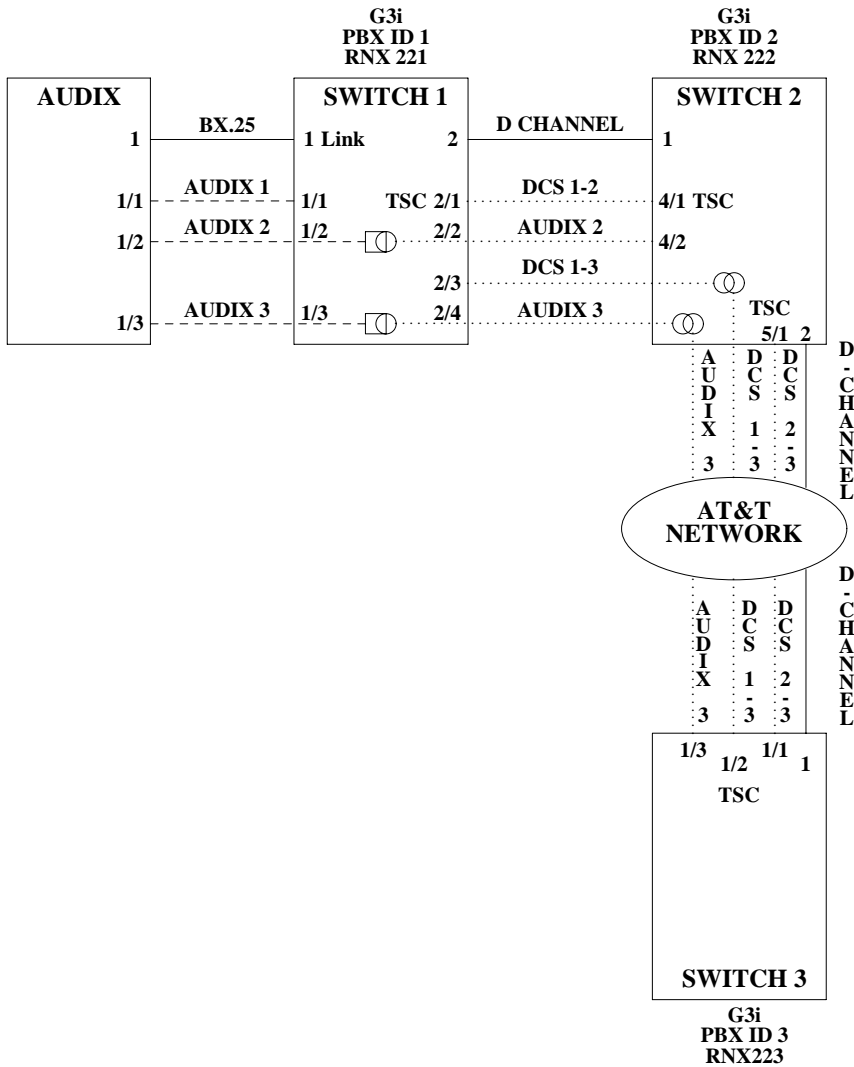

Figure 12-3. 3-Node public/private network

The following tables show you how you would complete each of the necessary forms.

### AUDIX administration

- AUDIX Translations form

| Switch Number | AUDIX Port | Switch Port <sup>1</sup> | Logical Channel | Data Link |
|---------------|------------|--------------------------|-----------------|-----------|
| 1             | 1          | 59                       | 1               | 1         |
| 2             | 2          | 57                       | 2               | 1         |
| 3             | 3          | 58                       | 3               | 1         |

- 
1. Switch Port refers to the processor channel that is used for AUDIX in the PBX.

### Administration for switch 1

- Dial Plan form

| Start Dig. | Len | Usage |
|------------|-----|-------|
| 4          | 4   | ext   |
| 5          | 4   | ext   |
| 6          | 4   | ext   |

- Uniform Dial Plan form

| Ext Code | Type    | Location Code |
|----------|---------|---------------|
| 5xxx     | UDPcode | 222           |
| 6xxx     | UDPcode | 223           |

- AAR Digit Conversion form

| Matching Pattern | Min | Max | Del | Replacement String | Net | Conv |
|------------------|-----|-----|-----|--------------------|-----|------|
| 221              | 7   | 7   | 3   | -                  | ext | n    |

- AAR Analysis Table

| Dialed String | Min | Max | Rte Pat | Call Type | Node Num |
|---------------|-----|-----|---------|-----------|----------|
| 222           | 7   | 7   | 2       | aar       | 2        |
| 223           | 7   | 7   | 3       | aar       | 3        |

**12 Private Networking**

*Distributed Communications System*

- Signaling Group form (signaling group 2)

| TSC Index | Local Ext. | Enabled | Establish | Dest. Ext. | Far-end PBX-ID | Appl    |
|-----------|------------|---------|-----------|------------|----------------|---------|
| 1         | 4900       | y       | permanent | 5900       | 2              | dcs     |
| 2         | 4901       | y       | permanent | 5901       | -              | gateway |
| 3         | 4902       | y       | permanent | 6902       | 3              | dcs     |
| 4         | 4903       | y       | permanent | 6903       | -              | gateway |

- Trunk Group form

| Group # | Grp Type | Used for DCS? | DCS Sig. Method | PBX ID |
|---------|----------|---------------|-----------------|--------|
| 2       | isdn-pri | y             | d-chan          | 2      |
| 3       | isdn-pri | y             | d-chan          | 3      |

- Routing Pattern form

| Routing Pattern # | Trunk Group # | FRL | Del | TSC | CA-TSC Request |
|-------------------|---------------|-----|-----|-----|----------------|
| 2                 | 2             | 0   | 3   | y   | at-setup       |
| 3                 | 3             | 0   | 3   | y   | at-setup       |

- Gateway Channel form

| Signaling Group | TSC Index | Processor Channel | Application |
|-----------------|-----------|-------------------|-------------|
| 2               | 2         | 60                | audix       |
| 2               | 4         | 61                | audix       |

- Processor Channel form

| Proc Channel | Application | Inter. Link | Channel | Remote Proc. Channel | PBX ID |
|--------------|-------------|-------------|---------|----------------------|--------|
| 59           | audix       | 1           | 1       | 1                    | 1      |
| 57           | gateway     | 1           | 2       | 2                    | -      |
| 58           | gateway     | 1           | 3       | 3                    | -      |

## Administration for switch 2

- Dial Plan form

| Start Dig. | Len | Usage |
|------------|-----|-------|
| 4          | 4   | ext   |
| 5          | 4   | ext   |
| 6          | 4   | ext   |

- Uniform Dial Plan form

| Ext Code | Type    | Location Code |
|----------|---------|---------------|
| 4xxx     | UDPcode | 221           |
| 6xxx     | UDPcode | 223           |

- AAR Digit Conversion form

| Matching Pattern | Min | Max | Del | Replacement String | Net | Conv |
|------------------|-----|-----|-----|--------------------|-----|------|
| 222              | 7   | 7   | 3   | -                  | ext | n    |

- AAR Analysis Table

| Dialed String | Min | Max | Rte Pat | Call Type | Node Num |
|---------------|-----|-----|---------|-----------|----------|
| 221           | 7   | 7   | 1       | aar       | 1        |
| 223           | 7   | 7   | 3       | aar       | 3        |

- Signaling Group form

Signaling group 4

| TSC   | Local | Enabled | Establish | Dest. | Far-end | Appl. |
|-------|-------|---------|-----------|-------|---------|-------|
| Index | Ext.  |         |           | Ext.  | PBX-ID  |       |
| 1     | 5900  | y       | permanent | 4900  | 1       | dcs   |
| 2     | 5901  | y       | permanent | 4901  | -       | audix |

Signaling group 5

| TSC   | Local | Enabled | Establish | Dest. | Far-end | Appl. |
|-------|-------|---------|-----------|-------|---------|-------|
| Index | Ext.  |         |           | Ext.  | PBX-ID  |       |
| 1     | 5905  | y       | permanent | 6905  | 3       | dcs   |



12 Private Networking

Distributed Communications System

- Trunk Group form

| Group # | Grp Type | Used for DCS? | DCS Sig. Method | PBX ID | NCA-TSC Sig. Group <sup>1</sup> |
|---------|----------|---------------|-----------------|--------|---------------------------------|
| 1       | isdn-pri | y             | d-chan          | 1      | -                               |
| 3       | isdn-pri | y             | d-chan          |        | 5                               |

1. This field is only used for tandeming.

- Routing Pattern form

| Routing Pattern # | Trunk Group # | FRL | Del | TSC | CA-TSC Request |
|-------------------|---------------|-----|-----|-----|----------------|
| 1                 | 1             | 0   | 3   | y   | at-setup       |
| 3                 | 3             | 0   | 3   | y   | at-setup       |

Administration for switch 3

- Dial Plan form

| Start Dig. | Len | Usage |
|------------|-----|-------|
| 4          | 4   | ext   |
| 5          | 4   | ext   |
| 6          | 4   | ext   |

- Uniform Dial Plan form

| Ext Code | Type    | Location Code |
|----------|---------|---------------|
| 4xxx     | UDPcode | 221           |
| 5xxx     | UDPcode | 222           |

- AAR Digit Conversion form

| Matching Pattern | Min | Max | Del | Replacement String | Net | Conv |
|------------------|-----|-----|-----|--------------------|-----|------|
| 223              | 7   | 7   | 3   | -                  | ext | n    |

**12 Private Networking**

*Distributed Communications System*

■ AAR Analysis Table

| Dialed String | Min | Max | Rte Pat | Call Type | Node Num |
|---------------|-----|-----|---------|-----------|----------|
| 221           | 7   | 7   | 1       | aar       | 1        |
| 222           | 7   | 7   | 2       | aar       | 2        |

■ Signaling Group form (signaling group 4)

| TSC Index | Local Ext. | Enabled | Establish | Dest. Ext. | Far-end PBX-ID | Appl. |
|-----------|------------|---------|-----------|------------|----------------|-------|
| 1         | 6905       | y       | permanent | 5905       | 2              | dcs   |
| 2         | 6902       | y       | permanent | 4902       | 1              | dcs   |
| 3         | 6903       | y       | permanent | 4903       | -              | audix |

■ Trunk Group form

| Group # | Grp Type | Used for DCS? | DCS Sig. Method | PBX ID |
|---------|----------|---------------|-----------------|--------|
| 1       | isdn-pri | y             | d-chan          |        |

■ Routing Pattern form

| Routing Pattern # | Trunk Group # | FRL | Del            | TSC | CA-TSC Request |
|-------------------|---------------|-----|----------------|-----|----------------|
| 1                 | 1             | 0   | 3 <sup>1</sup> | y   | at-setup       |

1. Should be blank if SDN network routing requires 7 digits.

**Interactions**

---

See the specific DCS features for interactions with each DCS feature.

## DCS Alphanumeric Display for Terminals

---

DCS Alphanumeric Display for Terminals allows calls to or from alphanumeric-display terminals to have transparency for call-related data.

The transparency allows calling-name display, called-name display, and miscellaneous identifiers to be transferred from a terminal on one node to a terminal on another node.

The following DCS configurations provide transparency of alphanumeric displays.

- Networks of 2 or more DEFINITY ECS
- Networks of 2 or more DEFINITY switches: (Generic 1 or Generic 3i) with a System 75 Version 3 or later, Generic 2, System 85 Release 2 Version 2 or later, or a Generic 2.1 as an intermediate node
- A DEFINITY system Generic 1 connected to a System 85 Release 2 Version 2 or later, or a Generic 2 or later.

### How to administer DCS Alphanumeric Display for Terminals

---

#### Required forms

| Form                       | Field            | Page                  |
|----------------------------|------------------|-----------------------|
| Trunk Group - Tie (DCS TG) | Outgoing Display | <a href="#">7-262</a> |

## DCS Attendant Control of Trunk Group Access

---

DCS Attendant Control of Trunk Group Access allows an attendant at any node in the DCS to control an outgoing trunk group at an adjacent node in the cluster.

To use this feature, you must have a DCS Trunk Group between the local and remote switches, and the trunks in that trunk group cannot insert digits on incoming calls. If you need digit insertion on these trunks, it should be added on the outgoing trunk based on the dialed string.

 **NOTE:**

DCS Attendant Control of Trunk Group Access is not available if you are using D-channel DCS.

### How to administer DCS Attendant Control of Trunk Group Access

---

#### Required forms

---

| Form              | Field   | Page                 |
|-------------------|---|----------------------|
| Attendant Console | <ul style="list-style-type: none"><li>■ Feature Button Assignments</li><li>— act-tr-grp</li><li>— deact-tr-g</li><li>— remote-tgs</li></ul> | <a href="#">5-35</a> |

---

## DCS Attendant Direct Trunk Group Selection

---

DCS Attendant Direct Trunk Group Selection allows attendants at one node to have direct access to an idle outgoing trunk at a different node in the DCS. This feature functions the same as regular Direct Trunk Group Selection, except attendants can access trunk groups at remote nodes.

### NOTE:

DCS Attendant Direct Trunk Group Selection is not available if you are using D-channel DCS.

To use this feature, you must have a DCS Trunk Group between the local and remote switches, and the trunks in that trunk group cannot insert digits on incoming calls. If you need digit insertion on these trunks, it should be added on the outgoing trunk based on the dialed digits.

You can assign a Trunk Hundreds Select button to access a trunk group at the local node or a trunk group at a remote node. A Trunk Group Select button assigned to access a remote node is referred to as a remote Trunk Hundreds Select button. Pressing a remote Trunk Group Select button is the same as dialing the tie trunk group access code for the remote node and the trunk access code of the selected trunk.

Each attendant console has 12 Trunk Hundreds Select buttons for Attendant Direct Trunk Group selection. Each button allows the attendant to directly access an outgoing trunk group by pressing the button assigned to that trunk group. Each button's Busy lamp lights when all trunks in its associated trunk group are busy. On a basic console, 6 of these buttons have 2 additional lamps for Attendant Control of Trunk Group Access. On an enhanced console, all 12 buttons have the additional lamps. The two additional lamps are:

- Warn (warning) lamp  
Lights when a preset number of trunks are busy in the associated trunk group.
- Cont (control) lamp  
Lights when the attendant activates Attendant Control of Trunk Group Access for the associated trunk group.

Users can activate attendant control of a remote trunk group in the DCS network by pressing the Cont button followed by the desired Remote Trunk Hundreds Select button. The initiating node sends a message to the remote node where the trunk group to be controlled resides to indicate that control of that trunk group was initiated.

When the remote node receives the activation message from the initiating node, it has 4 seconds to reply back to the initiating node whether control of the remote trunk group can be activated. If control of the remote trunk group can be

12 Private Networking

DCS Attendant Direct Trunk Group Selection

activated, a confirmation message is sent to the initiating node and the Cont lamp lights at the remote node. An error message is sent to the attendant at the initiating node if the trunk access code is invalid or if the trunk group is already controlled. An error message is also sent if the remote node is a System 85 or Enhanced DIMENSION PBX and the attendant does not have a Trunk Hundreds Select button with Cont lamp for that trunk group.

When a trunk group is controlled in a DCS environment, calls to the trunk group by anyone other than an attendant route to the local attendant at the node where the trunk group resides. If that node does not have an attendant, the call routes to a CAS main attendant or an attendant for Inter-PBX Attendant Calls. However, if CAS or Inter-PBX Attendant Calls is not provided, the party attempting to call on the controlled trunk receives intercept tone.

## How to administer DCS Attendant Direct Trunk Group Selection

---

### Required forms

---

| Form              | Field  | Page                 |
|-------------------|--|----------------------|
| Attendant Console | ■ Direct Trunk Group Select Button Assignments<br>— remote-tgs | <a href="#">5-35</a> |

---

## DCS Attendant Display

---

The DCS Attendant Display provides transparency for displaying call-related information.

Calls to and from DEFINITY ECS in a DCS environment have calling-party ID and called-party ID transparency when:

- The other party is at another Generic 1, Generic 3, or System 75, and the intermediate node is a Generic 1, Generic 2, Generic 3, System 75 Version 3 or later, or a System 85 Release 2 Version 2 or later.
- The other party is at a System 85 Release 2 Version 2 or later, or a DEFINITY system Generic 2 or later.
- The call is not routed through an intermediate System 85 Release 2 Version 1 or Enhanced DIMENSION PBX node. (These calls display only the extension of the calling party or called party.)

### How to administer DCS Attendant Display

---

#### Required forms

---

| Form              | Field                               | Page                 |
|-------------------|-------------------------------------|----------------------|
| Attendant Console | ■ Display Module Button Assignments | <a href="#">5-35</a> |
|                   | ■ Display Language                  |                      |

---

You administer DCS Attendant Display the same as you do Attendant Display. See [“Attendant Display” on page 4-74](#) for more information.

## DCS Automatic Callback

---

DCS Automatic Callback allows a user at one node to make an automatic callback call to a user at another node in the DCS.

A DCS Automatic Callback call can be initiated from a terminal at one node to a terminal at another node in the same way as if at a local node under the following conditions.

- If the called party is at a System 85, Generic 2, or Enhanced DIMENSION PBX node, the callback call can only be activated if the called node is returning busy tone or special audible ringback.
- If the called party is at a Generic 3, Generic 1 or System 75 node, the callback call can be activated if the called node is returning busy tone, Call Waiting ringback tone, or ringback tone.
- The calling party must disconnect within 6 seconds after hearing the confirmation tone for Automatic Callback activation.

Automatic Callback uses the following rules when the callback call is made to a user at another node:

- When the calling party answers the callback call, and no tie trunk to the called-party's node is available, Automatic Callback is reactivated toward the called party. The calling party hears confirmation tone instead of ringback when this occurs.
- If the calling party is on a System 85, Generic 2, or Enhanced DIMENSION PBX node and is unable to receive the callback call (for example, a busy single-line voice terminal without Call Waiting), Automatic Callback is reactivated by the calling party's node. If the calling party is on a Generic 3, Generic 1, or System 75 node and is unable to receive the callback call, the callback call is canceled.
- If the called party is unable to receive the callback call because they are busy again (for example, the called party goes on hook and then off hook immediately to place another call), the calling party hears busy tone again and can choose to reactivate Auto Callback, if desired.



## How to administer DCS Automatic Callback

### Required forms

| Form                              | Field  | Page                  |
|-----------------------------------|--|-----------------------|
| Feature-Related System Parameters | ■ Automatic Callback — No Answer Timeout Interval                    | <a href="#">5-123</a> |
| Feature Access Code (FAC)         | ■ Automatic Callback Activation<br>■ Automatic Callback Deactivation | <a href="#">5-113</a> |
| Station (multiappearance)         | ■ Button/Feature Button Assignments — auto-cback                     | <a href="#">6-14</a>  |
| Class of Service                  | ■ Automatic Callback (0–15)  | <a href="#">5-81</a>  |

You administer DCS Automatic Callback the same as you do Automatic Callback. See [“Automatic Callback” on page 4-100](#) for more information.

## DCS Automatic Circuit Assurance

---

DCS Automatic Circuit Assurance (ACA) allows a voice-terminal user or attendant at a node to activate and deactivate ACA referral calls for the entire DCS network. This transparency allows the referral calls to originate at a node other than the node that detects the problem.

If referral calls are generated at a node for one or more remote nodes, the remote nodes are notified when ACA referral is activated or deactivated. If referral calls are generated at a remote node for a DEFINITY ECS node, the DEFINITY ECS node is notified when ACA referral is activated or deactivated at the remote node. The lamp associated with the ACA button lights when ACA referral is activated and goes dark when ACA referral is deactivated. The ACA button serves no other purpose when a remote node generates the DEFINITY ECS referral calls.

### How to administer DCS ACA

---

#### Required forms

---

| Form                              | Field  | Page                  |
|-----------------------------------|--|-----------------------|
| Feature-Related System Parameters | ■ ACA Referral Calls   | <a href="#">5-123</a> |
| Attendant Console                 | ■ Feature Button Assignments<br>— aca halt   | <a href="#">5-35</a>  |
| Station (multiappearance)         | ■ Button/Feature Button Assignments<br>— aca halt  | <a href="#">6-14</a>  |
| Trunk Group (Tie)                 | ■ ACA Assignment<br>■ Long Holding Time<br>■ Short Holding Time<br>■ Short Holding Threshold | <a href="#">7-262</a> |

---

## DCS Busy Verification of Terminals and Trunks

---

DCS Busy Verification of Terminals and Trunks allows attendants and multiappearance voice-terminal users to make test calls to voice terminals and trunk groups that are located at other nodes in the DCS.

To use this feature, you must have a DCS Trunk Group between the local and remote switches, and the trunks in that trunk group cannot insert digits on incoming calls. If you need digit insertion on these trunks, it should be added on the outgoing trunk based on the dialed digits.

Attendants and voice-terminal users can busy-verify voice terminals at a remote location by pressing Verify and dialing the UDP extension. Verification continues as if the voice terminal is on the same node.

Multiappearance voice terminal users can busy-verify an adjunct at a remote location by pressing Verify and dialing the TAC of the tie trunk group to the remote node. Then they must press Verify a second time and dial the desired TAC and the trunk group member number to be verified. Verification of the trunk then continues as if the trunk is on the same node.

### How to administer DCS Busy Verification of Terminals and Trunks

---

#### Required forms

---

| Form                          | Field   | Page                 |
|-------------------------------|---|----------------------|
| Attendant Console             | Feature Button Assignments<br>— verify        | <a href="#">5-35</a> |
| Station<br>(multi-appearance) | Button/Feature Button Assignments<br>— verify | <a href="#">6-14</a> |

You administer DCS Busy Verification of Terminals and Trunks the same as you do Busy Verification of Terminals and Trunks. See [“Busy Verification of Terminals and Trunks” on page 4-130](#) for more information.

## DCS Call Coverage

---

DCS Call Coverage provides DCS messaging required for calls to be covered on remote systems when there is a DCS signaling link (BX.25 or ISDN-PRI) for the trunk groups. Calls to an extension on one system are covered by extensions on remote systems that are administered as coverage points.

### How to administer DCS Call Coverage

---

#### Required forms

---

| Form                                 | Field | Page                  |
|--------------------------------------|-------|-----------------------|
| All forms required for DCS           | All   | <a href="#">12-11</a> |
| All forms required for Call Coverage | All   | <a href="#">4-146</a> |

To administer DCS Call Coverage, you must have DCS software and UDP or PNA software. DCS Call Coverage must be enabled on all systems having principals or coverage points and on all intervening systems.

### Detailed description of DCS Call Coverage

---

DCS Call Coverage is similar to Call Coverage, with the following exceptions:

- Coverage Answer Groups across nodes are not supported.
- Under some conditions, a call follows the coverage point's coverage path. (See ["Operation Under Error Conditions" on page 12-40](#) for more information.)
- Under some conditions, Consult does not work properly. (See ["Operation Under Error Conditions" on page 12-40](#) for more information.)
- Displays differ in some cases. (See ["How to administer DCS Alphanumeric Display for Terminals" on page 12-27](#) for more details.)
- DCS Call Coverage does not support Coverage Call Back from a remote node.
- DCS Call Coverage supports Consult.



#### NOTE:

In releases prior to DEFINITY ECS and G3V4, DCS Call Coverage was limited to coverage of a single point and that point had to be an AUDIX, AUDIX DEFINITY, or INTUITY.

## DCS Call Coverage applications

Without DCS Call Coverage, the following coverage cannot be achieved:

- You spend time in multiple locations and want calls to Station B to be covered first by Station A and then by AUDIX, DEFINITY AUDIX, or INTUITY.
- You move from location A to location B and want calls to Station A to be covered first at Station B, then at AUDIX.
- You are normally located at Station B, but want calls to first be answered by an administrative assistant at Station A, and then by the AUDIX at location B.

See [Figure 12-4](#) for an example of a DCS Call Coverage configuration.

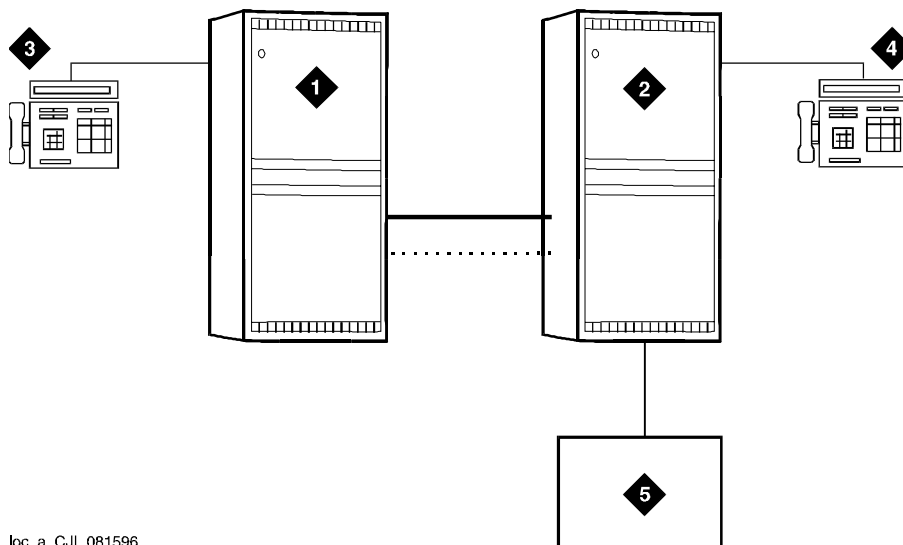

loc\_a CJL 081596

### Figure Notes

- |                              |                                     |
|------------------------------|-------------------------------------|
| 1. Location A - DEFINITY ECS | 4. Station B                        |
| 2. Location B - DEFINITY ECS | 5. AUDIX, DEFINITY AUDIX or INTUITY |
| 3. Station A                 |                                     |

Figure 12-4. Configuration for DCS Call Coverage

## DCS Call Coverage Operation

DCS Call Coverage allows calls to cover to points other than AUDIX on a remote system. Through DCS messaging, it provides transparency for Call Coverage. [Figure 12-5](#) shows an example of DCS Call Coverage.

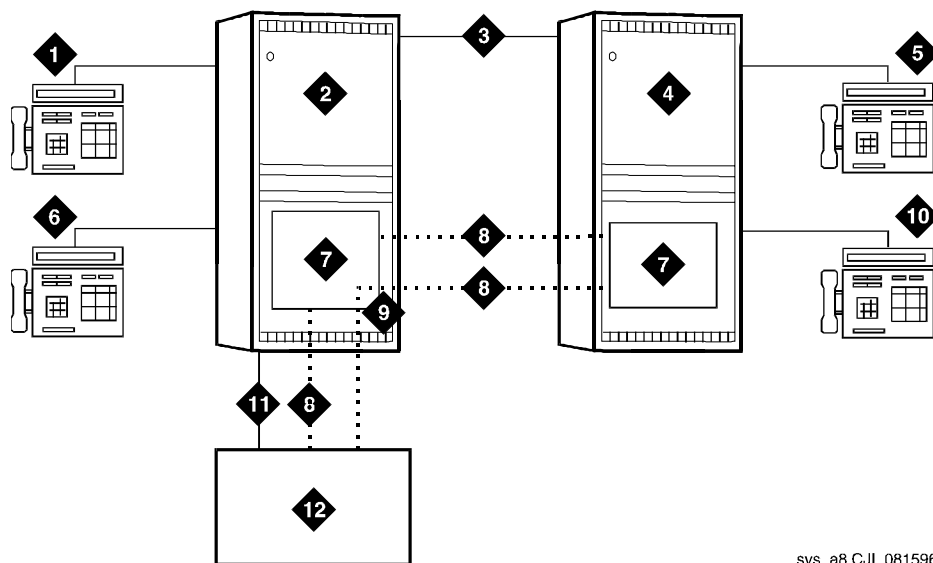

sys\_a8 CJL 081596

### Figure Notes

- |                            |  |
|----------------------------|--|
| 1. Station A               | 7. PGATE or PI Board                   |
| 2. System A - DEFINITY ECS | 8. X.25 or ISDN PRI DCS Signaling Link |
| 3. DCS Tie Trunk Groups    | 9. Hop or ISDN TSC Gateway             |
| 4. System B - DEFINITY ECS | 10. Station D                          |
| 5. Station C               | 11. AUDIX Voice Lines                  |
| 6. Station B               | 12. AUDIX - x34000                     |

**Figure 12-5. DCS Call Coverage**

In [Figure 12-5](#), calls to Station A can be covered first by Station B, then by Station C or D, and finally by the AUDIX on system A. Alternatively, calls could be covered by Station C, then Station B, then Station D, and so on.

If the called party answers after the call goes to coverage and the coverage point has answered, then the called party, calling party, and coverage point are all conferenced together.

If the called party answers and the coverage point has not answered, the call to the coverage point drops and the called party connects to the calling party.

### Operation under Normal Conditions

In a normal DCS Call Coverage configuration where the DCS link is up, the DCS trunk group is available, and DCS Call Coverage is active on the local and remote systems, DCS Call Coverage works as follows:

1. A call comes into the principal.
2. The principal does not answer within the administered number of rings or has Send All Calls active.
3. The call is redirected to the first coverage point, which is on the remote system. Also, at this time the DCS distinctive ringing message is sent to the coverage point along with 2 messages conveying the caller's name and the principal's name.
4. The coverage point rings with internal ringing (if the caller is on a DCS node) or with external ringing.
5. The covering station answers and receives the calling party's name and principal's name on the display.

Other DCS Call Coverage situations can occur which deviate from the normal operation, including:

- A call to the principal redirects to the remote coverage point, which is unavailable. The coverage point is considered unavailable when:
  - The coverage point is not a valid extension, QDN, or VDN.
  - The coverage point is busy with no hunting, forwarded, or has send all calls activated, or activates send all calls after ringing.
  - The coverage point has no staffed agents or an invalid vector.

When the coverage point is unavailable, the local system determines the availability status from a time-out or from a message from the remote system. When the local system discovers that the coverage point is unavailable, it tries the next coverage point. If the last coverage point is unavailable, the previous coverage point rings until it is answered or until the caller hangs up. If only one coverage point exists in the path and it is unavailable, the principal's station rings until it is answered or until the caller hangs up.

- A call to the principal is forwarded and the forwarded-to extension is not available. In this case, the first coverage point in the principal's path is tried. Note that the coverage does not follow the forwarded-to extension's coverage path.

- A call to the principal redirects to the remote coverage point, which answers. Subsequently, the principal goes off hook. In this case, the local system bridges the principal onto the call between the calling party and coverage point creating a conference among the three. The principal receives the call on the same call appearance as the original call.
- A call to the principal redirects to the remote coverage point. While the remote coverage point is ringing, the principal answers the call. In this case the call is not cut through to the coverage point. Instead, ringing and ringback is removed from the coverage point and the call is cut through to the principal.

### Operation Under Error Conditions

[Table 12-2](#) describes the DCS Call Coverage under error conditions.

**Table 12-2. Error Conditions**

| Error Condition   | Action   |
|---|--|
| DCS link not up.<br>or<br>DCS trunk is not available.<br>or<br>DCS Call Coverage feature is not activated on the remote system. | The call is routed to the remote coverage point. If the call is answered, it is treated as Call Coverage Off Premises (also called Remote Call Coverage). If the call is redirected at the remote coverage point before the DCS SRI expires, the remote point's path is followed. If the call is not answered within the DCS SRI time-out period, the next coverage point is tried with DCS Call Coverage from the local system. |
| All trunks to the remote system, DCS or otherwise, are busy   | The next coverage point is tried with DCS Call Coverage from the local system.   |

In addition, when the DCS link is down, call consult operates differently. If Station A calls Station B but the call covers to Station C, then Station C consults back to Station B and Station B receives the consult call on the next call appearance.



## DCS Call Forwarding

---

DCS Call Forwarding allows all calls to an extension to be forwarded to a selected extension in the DCS network or to an external (off-premises) number.

If the Call Forwarding and DCS Call Forwarding are both active, and if a call is forwarded between extensions on the same node, the Call Forwarding coverage path is used. If the nodes are different, the DCS Call Forwarding coverage path is used.

Voice-terminal users in the DCS can activate/deactivate this feature with a dial access code or with a Call Forwarding button.

### NOTE:

Calls can be forwarded to a Vector Directory Number (VDN) anywhere in the DCS network. An attendant cannot activate/deactivate Call Forwarding for a VDN.

## How to administer DCS Call Forwarding

---

### Required forms

---

| Form                      | Field   | Page                  |
|---------------------------|---|-----------------------|
| Feature Access Code (FAC) | ■ Call Forwarding Activation                      | <a href="#">5-113</a> |
|                           | ■ Call Forwarding Deactivation                    |                       |
| Station                   | ■ Redirect Notification                           | <a href="#">6-28</a>  |
|                           | ■ Button/Feature Button Assignments<br>— call-fwd |                       |
| Class of Service          | ■ Call Fwd-All Calls (0-15)                       | <a href="#">5-81</a>  |

You administer DCS Call Forwarding the same as you do Call Forwarding. See [“Call Forwarding” on page 4-224](#) for more information.

## DCS Call Waiting

---

DCS Call Waiting allows calls from one node to busy single-line voice terminals at another node to wait until the called party is available to accept the call. With DCS Call Waiting, a single-line voice terminal user, by knowing a call is waiting, can quickly process calls from locations within the DCS. DCS Call Waiting functions the same as normal Call Waiting.

DCS Call Waiting includes the following features:

- Attendant Call Waiting
- Call Waiting — Termination
- Priority Calling

DCS priority calling from the attendant station is *not* available.

### How to administer DCS Call Waiting

---

None

## **DCS Distinctive Ringing**

---

DCS Distinctive Ringing activates the called-terminal alerting or ringing device to indicate the type of incoming call to the user before they answer it. Distinctive Alerting functions in a DCS environment the same as it does within a single system.

By default, internal calls are identified by a 1-burst ringing pattern, external calls by a 2-burst ringing pattern, and priority calls by a 3-burst ringing pattern. However, you can administer these patterns.

### **How to administer DCS Distinctive Ringing**

---

None.

## DCS Leave Word Calling

---

DCS Leave Word Calling (LWC) enables users to leave preprogrammed “call me” messages at other terminals within the DCS network. Messages can be left by calling, called, or covering users.

LWC transparency in a DCS configuration allows messages from a DEFINITY switch to another node, depending on the storage capability of the remote node.

### How to administer DCS LWC

---

#### Required forms

---

| Form                              | Field  | Page                  |
|-----------------------------------|--|-----------------------|
| Feature-Related System Parameters | ■ Max. Number Of Messages Per Station                    | <a href="#">5-123</a> |
|                                   | ■ Stations With System-Wide Message Retrieval Permission |                       |
| Feature Access Code (FAC)         | ■ LWC Message Retrieval Lock                             | <a href="#">5-113</a> |
|                                   | ■ LWC Message Retrieval Unlock                           |                       |
|                                   | ■ LWC Send A Message                                     |                       |
|                                   | ■ LWC Cancel A Message                                   |                       |
| Station                           | ■ LWC Reception  | <a href="#">6-28</a>  |
|                                   | ■ LWC Activation   |                       |
|                                   | ■ Button/Feature/Button Assignments                      |                       |
|                                   | — lwc-store  |                       |
|                                   | — lwc-cancel   |                       |
|                                   | — aut-msg-wt (Ext: __)                                   |                       |
|                                   | — msg-retr   |                       |
|                                   | — delete-msg   |                       |
|                                   | — lwc-lock   |                       |
|                                   | — next   |                       |
| — call-disp                       |  |                       |
| — cov-msg-rt                      |  |                       |

---

*Continued on next page*

**Required forms — Continued**

---

| <b>Form</b>       | <b>Field</b>               | <b>Page</b>          |
|-------------------|----------------------------|----------------------|
| Attendant Console | Feature Button Assignments | <a href="#">5-35</a> |
|                   | — cov-msg-rt               |                      |
|                   | — delete-msg               |                      |
|                   | — next                     |                      |
|                   | — lwc-cancel               |                      |
|                   | — call-disp                |                      |
|                   | — lwc-store                |                      |
|                   | — aut-msg-wt (Ext: __)     |                      |

---

You administer DCS LWC the same as you do LWC. See [“Leave Word Calling” on page 4-405](#) for more information.

## **DCS Multiappearance Conference/ Transfer**

---

DCS Multiappearance Conference/Transfer provides transparency for transferring calls and conferencing calls within a DCS network. A user in the DCS can initiate conference calls among or transfer calls originated from extensions in the DCS network to another extension within the DCS by dialing the UDP extension. (For transferred calls, the destination need not be within the DCS.)

In a DCS, if a party in a conference hangs up or completes a transfer leaving only outgoing trunks on the call, the system attempts to preserve the connection if any of the remaining parties on the call is a DCS tie trunk.

The display transparency is not preserved after a conference of transfer across the DCS network.

### **How to administer DCS Multiappearance Conference/Transfer**

---

None.

## DCS Over ISDN-PRI D-channel

---

DCS Over ISDN-PRI D-channel (DCS+) enhances DCS by allowing access to the public network for DCS connectivity between DCS switch nodes. With this feature, DCS features are no longer restricted to private facilities.

The ISDN-PRI B-channel is used for voice communications, and the ISDN-PRI D-channel transports DCS control information. The only difference between DCS networks that do not utilize the DCS Over ISDN-PRI and those that do is in the method of signaling. The DCS Over ISDN-PRI D-channel uses Message-Associated User-to-User Information (MA-UUI) and Temporary Signaling Connections (TSC) to transport certain DCS control information. MA-UUI allows additional user-specific information to be transported along with certain ISDN call-control messages.

 **NOTE:**

Use this feature only over DS1/E1 or T1 circuit packs that are administered to Country Protocol Option 1 (even in a private network environment) independent of what country the system is in.

### How to administer DCS Over ISDN-PRI D-channel

---

#### Required forms

---

| Form                                 | Field                                    | Page                  |
|--------------------------------------|--|-----------------------|
| Signaling Group                      | ■ Max number of NCA TSC                  | <a href="#">7-106</a> |
|                                      | ■ Max number of CA TSC                   |                       |
|                                      | ■ Trunk Group for NCA TSC                |                       |
|                                      | ■ Administered NCA TSC Assignment fields |                       |
|                                      | ■ Service/Feature                        |                       |
|                                      | ■ Inactivity Time-out (min)              |                       |
| ISDN TSC Gateway Channel Assignments | ■ All                                    | <a href="#">7-98</a>  |
| Trunk Group (ISDN-PRI)               | ■ Used for DCS Node Number DCS Signaling | <a href="#">7-219</a> |
|                                      | ■ NCA TSC Signaling Group                |                       |

---

*Continued on next page*

**Required forms — Continued**

| Form                         | Field                            | Page   |
|------------------------------|----------------------------------|--|
| Route Pattern                | ■ TSC                            | <a href="#">8-67</a>                                 |
|                              | ■ CA TSC Request                 |  |
| Processor Channel Assignment | ■ Application                    | <a href="#">5-248</a><br>or<br><a href="#">5-252</a> |
|                              | ■ Record TSCs for CDR Parameters | <a href="#">5-123</a>                                |

**NOTE:**

There are several differences in administration between switches. For example, PRI is translated a little differently in G3r when traditional DCS and this feature are used in combination. On systems with AUDIX in a DCS environment, an additional column has been added to the Signaling Group form so you can specify which AUDIX and switch to use. When traditional DCS and DCS over ISDN are used in combination, translations are also different.

**Detailed description**

A TSC provides a temporary signaling path through ISDN switches for exchanging supplementary service information on ISDN-PRI D-channels. There is no B-channel related to the connection; no data or voice transmissions take place.

There are two types of temporary signaling connections:

- Call Associated (CA-TSC)
- Non-Call Associated (NCA-TSC)

A CA-TSC refers to a service for exchanging USER INFORMATION messages associated with an ISDN B-channel connection by the call reference value of the call control data packets. On DEFINITY ECS, this type of TSC is used only for DCS features on ISDN-PRI Signaling Groups administered with Supplementary Service Protocol a.

An NCA-TSC is a connection not related with any ISDN B-channel connections. DEFINITY ECS supports two types of NCA-TSC that conform to two different protocol standards:



## 12 Private Networking

### DCS Over ISDN-PRI D-channel

Page 12-49

- The AT&T type of NCA-TSC is used for the DCS Over ISDN-PRI D-channel and DCS AUDIX applications. Only ISDN-PRI Signaling Groups administered with Supplementary Service Protocol a support AT&T NCA-TSCs.
- The QSIG type of NCA-TSC is used for certain QSIG features such as Call Completion (Automatic Call Back). This type of NCA-TSC is referred to in the QSIG protocol standards as a Call-Independent Signaling Connection (CISC). Only ISDN-PRI Signaling Groups administered with Supplementary Service Protocol b support QSIG NCA-TSCs.

For further information, see [“QSIG NCA-TSC” on page 12-80](#).

## AT&T NCA-TSC

An AT&T NCA-TSC is an administered virtual connection established for exchanging USER INFORMATION messages on the ISDN D-channel. Once an AT&T NCA-TSC has been administered and enabled, it is active for an extended period of time. There are two types of administered NCA-TSCs depending on their setup mechanism:

- Permanent (can be established by Near-end or Far-end)
- As-needed

Once enabled, a permanent NCA-TSC remains established while the system is running. If the permanent NCA-TSC drops for any reason, the system attempts to reestablish the connection. An as-needed administered NCA-TSC is established based on user request and the availability of TSC facilities. The connection drops after an administered period of inactivity.

The system can transport DCS or DCS AUDIX messages over an ISDN-PRI D-channel and over BX.25 data links when functioning as a gateway between a switch equipped with DCS Over ISDN-PRI D-channel and a switch equipped with traditional DCS using BX.25 data links. In this situation, the messages travel from the gateway through the NCA-TSCs or CA-TSCs to TSC-capable switches and from the gateway to switches that support only traditional DCS via a BX.25 logical channel.

At least one switch must be configured as an ISDN DCS Gateway node in a DCS network that consists of switches that support DCS Over ISDN-PRI D-channel and PBXs that do not support the feature. Switches directly connected to AUDIX serve as Gateway nodes.

## DCS with Rerouting

---

Distributed Communications System (DCS) with Rerouting allows a call's connection between two DEFINITY systems to be replaced by a new connection. All of the trunks used in the original path must be DCS and the new path utilizes only DCS trunks. DCS with Rerouting provides the following capabilities:

- Attempts to obtain a better (generally less expensive) connection.
- May replace the current path of a call with a route that is better in terms of Automatic Alternate Routing/Automatic Route Selection (AAR/ARS) routing preferences administered on a DEFINITY ECS.
- Frees up resources being used unnecessarily.

### How to administer DCS with Rerouting

---

#### Required forms

| Form        | Field | Page                  |
|-------------|-------|-----------------------|
| Trunk Group |       |                       |
| ISDN-PRI    | All   | <a href="#">7-219</a> |

### Detailed description

---

DCS with Rerouting primarily provides you with the ability to attempt to be more effective with the usage of Trunk groups administered for Supplementary Services Protocol Option E (SSE) during the existence of an active call. This means using a more preferred route (in terms of UDP/AAR/ARS routing preferences administered on the PBX) between the PBXs involved.

Your users invoke DCS with Rerouting by Call Transfer, Transfer out of Audix, and dial 0 out of Audix. DCS with Rerouting must be enabled on a switch-wide basis and the trunk groups involved must be administered as SSE.

### Considerations

---

- DCS with Rerouting could fail.
- Depending upon administration of routing patterns, the new route could be worse than the original.

## Interactions

---

- When interworking with non-ISDN trunks or non-Supplementary Service Option E ISDN trunks, DEFINITY acts as a gateway in the following sense:
  - When a call is tandeming through a DEFINITY system from a non-ISDN trunk to an SSE trunk or from a non-Option E to an SSE trunk, the system acts as an incoming gateway.
  - When a call is tandeming through a DEFINITY system from an SSE trunk to a non-ISDN trunk or from an SSE trunk to a non-Option E trunk, the system acts as an outgoing gateway.

As an example, when calls come in from the public network to the DCS network and then are transferred to another extension within the private network, DEFINITY functions as an incoming gateway and rerouting occurs.
- If a conference call is transferred, rerouting will not occur.
- Trunks or endpoints measured by the Call Management System (CMS) will not have rerouting take place.
- Trunks or endpoints that are involved with vectoring or announcements will not have rerouting take place.

## DCS Trunk Group Busy/Warning Indication

---

DCS Trunk Group Busy/Warning Indication provides attendants with a visual indication that the number of busy trunks in a remote group reached an administered level. A visual indication is also provided when all trunks in a trunk group are busy.

### NOTE:

DCS Trunk Group Busy/Warning Indication is not available if you are using DCS over ISDN-PRI.

To use this feature, you must have a DCS Trunk Group between the local and remote switches, and the trunks in that trunk group cannot insert digits on incoming calls. If you need digit insertion on these trunks, it should be added on the outgoing trunk based on the dialed digits.

You can administer DCS Trunk Group Busy/Warning Indication only for remote trunk groups that are directly connected to the local switch. Trunk group access codes for these trunk groups must be 3 digits or less.

If an attendant has a Trunk Hundreds Select button assigned to a remote trunk group, the button's Busy lamp lights when all trunks in the trunk group are busy. If an attendant has a 3-lamp Trunk Hundreds Select button assigned to a remote trunk group, the button's Warn lamp lights when the number of busy trunks in the trunk group reaches the Busy Warning Threshold.

To ensure that the busy, warning, and control status of all Trunk Hundreds Select buttons in the DCS remain consistent with the status of the corresponding trunk groups, some nodes in the DCS broadcast the status of a different local trunk group, every 50 seconds, to all directly connected nodes. (A pair of DCS nodes are directly-connected if the voice tie trunks between them are not connected through another switch). For example, a node with 30 trunk groups would take 1,500 (50 x 30) seconds to broadcast the status of all 30 trunk groups. This is called a lamp audit. When a node receives a lamp audit message, its TGB/TGW lamps update accordingly.

## How to administer DCS Trunk Group Busy/Warning Indication

---

### Required forms

---

| Form               | Field  | Page                  |
|--------------------|--|-----------------------|
| Attendant Console  | ■ Direct Trunk Group Select Button Assignments<br>— (1–6) for 301A Basic<br>or<br>— (1–12) for the 302A Enhanced Attendant Console | <a href="#">5-35</a>  |
| Trunk Groups (All) | ■ Busy Threshold   | <a href="#">7-115</a> |

---

## Emergency (911) Calls

---

The Enhanced 911 (E911) systems installed in many jurisdictions in the U.S. are equipped so that by dialing a service code (911 in the U.S.) a victim of a fire, accident, crime, or medical emergency may quickly access a public safety agency that will dispatch the appropriate response. The public E911 system maintains a database that stores location and background information to aid public safety agencies in responding quickly with the appropriate assistance. Information about the calling party can be triggered by the transmission of a Caller's Emergency Service Identification (CESID) number over Centralized Automatic Message Accounting (CAMA) trunks when the call originates from behind a PBX. 911 calls from a station on a PBX not equipped with CAMA trunks (or an adjunct computer system associated with CAMA trunks) will not provide the E911 system with the information required to identify the location of the person placing the call. Instead, the E911 system will only be able to identify the location of the trunk termination at the PBX.

This feature allows transmission of identifying information in the form of the CESID over CAMA trunks as to the extension number of a DID station associated with the calling party. The calling party may be at or near a station on a remote port network, or may be at a remote location served by an off-premises station.

### How to administer Emergency (911) Calls

---

#### Required forms

| Form                     | Field                                    | Page                  |
|--------------------------|--|-----------------------|
| ARS Digit Analysis Table | ■ All                                    | <a href="#">8-55</a>  |
| CAMA Numbering Format    | ■ All                                    | <a href="#">5-61</a>  |
| Class of Restriction     | ■ Calling Party Restriction              | <a href="#">5-72</a>  |
| Feature Access Code      | ■ ARS Access Code1<br>■ ARS Access Code2 | <a href="#">5-113</a> |
| Route Pattern            | ■ All                                    | <a href="#">8-67</a>  |
| Trunk Group (CAMA)       | ■ All                                    | <a href="#">7-161</a> |

### Interactions

---

None.

## Enhanced DCS

---

Enhanced DCS (EDCS) adds features to the existing DCS capabilities.EDCS is used primarily in Italy. EDCS adds the following features:

- Exchanging information to provide class of restriction (COR) checking between switches in the EDCS network
- Providing call-progress information for the attendant
- Allowing attendant intrusion between a main and a satellite
- Allowing a main PBX to provide DID/CO intercept treatment rather than the satellite PBX.

 **NOTE:**

EDCS is not compatible with DCS Over/Under ISDN-PRI. If used with ISDN-PRI, configure the switch as a DCS node. Also, DCS-ISDN display enhancements are not currently available in EDCS.

### How to administer Enhanced DCS

---

#### Required forms

---

| Form                              | Field                              | Page                  |
|-----------------------------------|------------------------------------|-----------------------|
| Feature-Related System Parameters | ■ Enhanced DCS Enabled?            | <a href="#">5-123</a> |
|                                   | ■ Apply Intercept Locally?         |                       |
|                                   | ■ Enforce PNT-to-PNT Restrictions? |                       |

---

## DCS feature considerations

---

- The DS1 Circuit Pack form must be completed if DS1 tie trunks are used for DCS signaling.
- The Synchronization Plan form must be completed if DS1 tie trunks are used for DCS signaling. You assign a secondary circuit pack that the system can use if the primary circuit pack fails.
- If you call an attendant on another switch in the DCS network, your display shows the attendant's name, but does not show the attendant's extension, instead you see a zero where the extension should be.

### DCS Alphanumeric Display considerations

- Calls to and from a DEFINITY ECS in a DCS network have Calling/Called Name Display transparency under the following conditions:
  - The other party is at another DEFINITY ECS or a DEFINITY Generic 3 and the tandem node is a System 75 Version 3 or later, DEFINITY Generic 1, DEFINITY Generic 3, System 85 Release 2 Version 2 or later, or a DEFINITY Generic 2.1.
  - The call is not routed through a tandem System 85 Release 2 Version 1 or Enhanced DIMENSION PBX node. (Such calls display only the extension number of the calling or called party.)
- On outgoing DCS calls, display of the called name may be delayed for a few seconds until the required information arrives from the distant node. The called name display only works between DEFINITY ECS, DEFINITY Generic 1 and Generic 3 Systems, and System 75s.
- Within the same DEFINITY ECS, DEFINITY Generic 1 or Generic 3 nodes in a DCS, complete transparency of Calling and Called Name Display exists.

### DCS Attendant Control of Trunk Group Access considerations

- This feature is not available for trunk groups with 4-digit trunk access codes or for trunk members 100 through 999.
- There must be direct DCS tie trunk connections between the initiating node and the remote node where the trunk group to be controlled originates. Otherwise, control of remote trunk groups is denied.
- If the remote node (where the trunk group to be controlled resides) is a System 75, Generic 1, or Generic 3, it is not necessary for that node to have an attendant console with corresponding three-lamp Trunk Hundreds Select button. However, if the remote node is a System 85, Generic 2.1, or Enhanced DIMENSION PBX, control of the trunk group is not allowed unless an attendant at that node has a corresponding three-lamp Trunk Group Select button.



## **12 Private Networking**

### *DCS feature considerations*

*Page 12-57*

- The attendant must use the Remote Trunk Hundreds Select button to directly access the controlled remote trunk group. If an attendant controls a remote trunk group, and that attendant dials the trunk access codes of the DCS tie trunk and the controlled remote trunk group, the call is routed to the attendant at the node where the trunk group resides.
- If Attendant Control of Trunk Group Access is activated, and no attendant is assigned, or the attendant is later removed, calls to a controlled trunk group route to the attendant queue.

### **DCS Attendant Direct Trunk Group Selection considerations**

- This feature is not available for trunk groups with 4-digit trunk access codes or for trunk members 100 through 999.
- There must be a direct DCS tie trunk connection between the initializing node and the remote node where the trunk group to be accessed originates. Otherwise, access to the remote trunk group is denied.

### **DCS Attendant Display considerations**

- CORs for a DEFINITY switch may not correspond to those used by an Enhanced DIMENSION PBX, System 85, or DEFINITY system Generic 2.1. Therefore, if the DCS network contains nodes other than Generic 1 or Generic 3, the display CORs may be misinterpreted. If it is important that certain CORs between various systems correspond with each other, those CORs should be administered accordingly.
- On outgoing calls, the display of called party information may be delayed a few seconds until the required information arrives from the remote node. The called party information is displayed only if both nodes are Generic 1 or System 75.
- DCS tie trunks between nodes must be administered with the Outgoing Display enabled. This enables the called party's name to be displayed at the calling attendant's display.

### **DCS Automatic Callback considerations**

- An Automatic Callback request is canceled automatically if the called party does not become available within 40 minutes, or if the calling party does not hang up within six seconds after activating Automatic Callback.
- DCS Automatic Callback does not work on the last trunk between nodes. Thus, if  $n$  trunks are provided, there can be up to  $n - 1$  Automatic Callback calls.

### **DCS Busy Verification of Terminals and Trunks considerations**

- This feature is not available for trunk groups with 4-digit trunk access codes or for trunk members 100 through 999.

### DCS Call Coverage considerations

- The following software is required for DCS Call Coverage.
  - DCS software
  - UDP or PNA software
  - DCS Call Coverage must be enabled on all systems having principals or coverage points and on all intervening systems.

### DCS Call Forwarding considerations

- With DCS Call Forwarding, voice terminal users can have their calls follow them to any location within the DCS network or outside the DCS network.
- Calls to an attendant cannot be forwarded. However, an attendant can activate or deactivate the feature for other extension numbers within the DCS.

### DCS Distinctive Ringing considerations

- When DCS transparency is lost for any reason, terminal-to-terminal calls made between nodes produce external ringing instead of the usual internal ringing. Loss of transparency may occur when the data link between nodes is down or when data transmission delay exceeds the trunk signaling time.

### DCS LWC considerations

- LWC cannot be successfully activated toward any system that is not capable of storing the messages, either internally or in an associated adjunct.
- Messages from one node, through an intermediate node, to a remote node do not require storage capability at the intermediate node.
- LWC transparency is supported for all DCS configurations except for cases when either the activating node or the remote node is either an ENHANCED DIMENSION PBX or a System 85 R2V1.
- Retrieval of LWC messages is permitted only from a terminal at the node where the messages are stored.
- DCS LWC cannot be activated from an attendant console.

### DCS Multiappearance Conference/Transfer considerations

- DCS Multi-Appearance Conference/Transfer is useful when it is necessary to talk to more than one party at one time within a DCS. Multiappearance voice terminals must have an idle appearance in order to transfer a call.

## DCS Over ISDN-PRI D-channel considerations

- Users should not notice any difference between DCS features over ISDN-PRI and traditional DCS features.
- The gateway node serves as the terminating node to the D-channel DCS network as well as the terminating node to the traditional DCS network.

A PBX serving as an ISDN DCS Gateway node introduces some interesting situations when administering processor channels in an associated traditional DCS PBX. In a traditional DCS network, (BX.25 processor channel links) `Remote Port` in the "Processor Channel Assignments" form refers to the processor channel of the destination PBX. In an Integrated DCS network, `Remote Proc Chan` in the "Processor Channel Assignments" form refers to the processor channel of the Gateway PBX (if the destination PBX is an ISDN DCS PBX), *not* the destination PBX.

On the contrary, `Machine-ID` in the "Processor Channel Assignments" form refers to the destination PBX, either an ISDN DCS PBX or a traditional DCS PBX. The Gateway PBX number *must not* be used in this field if the destination PBX is an ISDN DCS PBX.

## DCS Trunk Group Busy/Warning Indication considerations

- This feature is not available for trunk groups with 4-digit trunk access codes or for trunk members 100 through 999.
- Trunk Group Busy and Trunk Group Warning Indication is particularly useful with the Attendant Control of Trunk Group Access feature. The indicators alert the attendant when control of access to local and remote trunk groups is necessary.
- Except for remote S75 R1V3, S85/G2 and S75 R1V2 switches, this feature is only transparent if the remote switch is directly connected by voice tie trunks. For S75 R1V3 and S85/G2 remote switches, Trunk Group Busy and Trunk Group Warning Indication is provided regardless of whether the voice tie trunks are directly-connected or in tandem through an intermediate node; For S75 R1V2 remote switches, no Trunk Group Busy and Trunk Group Warning Indication transparency is provided.

## Enhanced DCS considerations

- If the DCS link fails, the administrator can choose to allow calls to continue without class of restriction checking or to block all DCS calls to inward-restricted stations.
- Enhanced DCS is not available with DCS over an ISDN-PRI D-channel. When EDCS is used, all nodes in the DCS network must use EDCS.
- The DCS Transfer display enhancements and DCS Conference display enhancements do not apply when EDCS is enabled.

## DCS Interactions

---

### DCS Alphanumeric Display interactions

The following features allow transparency with respect to Calling or Called Name Display and miscellaneous ID.

- Automatic Callback  
Complete display transparency.
- Call Coverage  
At the calling terminal, the miscellaneous id “cover” is not displayed.
- Call Forwarding  
When a system user calls a party on a different node in the DCS and the call is forwarded, the miscellaneous ID “forward” is not displayed. At the covering (forwarded-to) user’s terminal, only the calling party’s name is shown; the called party’s name is not displayed.
- Call Park  
When a DCS call between a local system user and a user on another node is parked by the remote user, the miscellaneous ID “park” is not displayed at the local terminal.
- Call Pickup  
When a DCS call from a system user to another node is answered by way of Call Pickup, the miscellaneous ID “cover” is not displayed at the caller’s terminal.
- Call Waiting  
When a DCS call from a system user to another node is waiting at the called terminal, the miscellaneous ID “wait” is not displayed at the caller’s terminal.
- CAS  
When a user dials the extension for CAS, a RLT is seized or the caller is queued for an RLT. The caller’s terminal displays the trunk group identifier, such as OPERATOR.
- Conference  
When two DCS and/or ISDN-PRI calls (or any possible combination of each) are conferenced and revert to a two-party call, the trunk group of the remaining call is displayed.
- DDC/UCD  
Complete display transparency.
- Internal Terminal-to-Terminal Calling  
Complete display transparency.

- ISDN-PRI

If both DCS and ISDN-PRI features are provided with a system, the ISDN-PRI display information displays in DCS format.

### **DCS Attendant Control of Trunk Group Access interactions**

- DCS Attendant Display

When a user attempts to access a controlled trunk group and is routed to the local attendant, the display shows the reason the call was redirected. If the call is routed via CAS or the Inter-PBX Attendant Calls feature, the display does not show the reason the call was redirected.

- UDP

DCS tie trunks should not be attendant controlled. This would result in all UDP calls on the controlled tie trunk being routed to the controlling attendant instead of to the desired destination.

### **DCS Attendant Display interactions**

- When both ISDN and DCS display information, or only DCS display information, is received, the switch displays the DCS display information in the DCS format. If ISDN display information is received, and no DCS display information is received, then the ISDN display information displays in the ISDN formats.

### **DCS Automatic Callback interactions**

- Attendant Control of Trunk Group Access and DCS Attendant Control of Trunk Group Access

Automatic Callback cannot be activated if the call uses a controlled trunk group.

- Call Forwarding and DCS Call Forwarding

Automatic Callback calls cannot be activated on a voice terminal at a DEFINITY switch or System 75 node that has Call Forwarding activated.

- Vector Directory Number

Automatic callback calls do not apply for VDNs.

### **DCS Automatic Circuit Assurance interactions**

- None.

### **DCS Busy Verification interactions**

- If the Trunk Identification by Attendant feature is used during busy verification of a trunk (Trunk ID button is pressed), the trunk access code and trunk group member number of the DCS tie trunk being used is displayed.

- DCS Busy Verification of Terminals and Trunks transparency is lost if the routing pattern is administered to not delete the RNX and the AAR prefix is inserted on the terminating switch trunk group. The voice terminal display at the terminating switch displays only **a=station name**. `Extension` is left blank.

## DCS Call Coverage interactions

DCS Call Coverage has the same interactions as Call Coverage plus the following additional interactions.

- Call Coverage Off Premises

If the coverage point is a non-UDP number in the remote call coverage table, Call Coverage Off Premises is applied to the call rather than DCS Call Coverage, even if a DCS link exists to the remote system.

- Coverage Answer Groups

DCS Call Coverage to Coverage Answer Groups on remote systems are not supported by DCS Call Coverage. Coverage answer groups cannot be administered on a system other than the principal's system.

- Coverage Call Back

DCS Call Coverage does not support Coverage Call Back from a remote node. This is because the coverage point's system has no way of knowing whether the caller can respond to Leave Word Calling. For example, the coverage point's system does not know whether the calling party is a trunk or a station.

- Displays

The displays on the DCS Call Coverage point's terminal may be different than those associated with the Call Coverage feature in the following situations:

- When the call from the calling party to the principal or the redirected call to the coverage point travel over ISDN-PRI trunk groups.
- When the calling party is on a System 85 or Generic 2.
- When the DCS name message is not received by the remote (coverage point's) system.

- Go to Cover

Go to Cover is not supported over DCS and therefore is not supported with DCS Call Coverage.

- Leave Word Calling Back to Principal

With DCS Call Coverage, a covering user on a different node cannot press their LWC button to leave a message for the principal to call the covering user.

## 12 Private Networking

### DCS feature considerations

Page 12-63

- **Queuing**

DCS Call Coverage interacts with queuing in the following way. If a call is queued to a coverage point, such as a queue to a hunt group or an ACD split, and the queue is not full, the call remains in the queue without subsequent redirection until answered or until the caller hangs up.

### DCS Call Forwarding interactions

- If the forwarding extension and the designated extension are at different nodes, and the designated extension's coverage criteria are met on a forwarded call, the call is redirected to a point in the designated extension's coverage path.
- If the forwarding extension and the designated extension are at different nodes, LWC and Coverage Callback cannot be activated at the designated extension for a forwarded call.
- There is a 30-second interval during which calls forwarded from the DEFINITY switch to another DCS node is denied. This prevents forwarded incoming trunk calls from being forwarded ad infinitum between two extensions.

### DCS Call Waiting interactions

- DCS Call Waiting is denied when the following features are activated at the single-line voice terminal:
  - Automatic Callback (to or from the voice terminal)
  - Data Privacy
  - Data Restriction
- On incoming trunk calls to the attendant extended over DCS trunks, Attendant Call Waiting interacts with the EDCS feature.

### DCS Distinctive Ringing interactions

- **Distinctive Ringing**

Distinctive Ringing treats a call from another switch in a DCS arrangement as external; DCS Distinctive Ringing treats such calls as internal. If both features are administered, DCS Distinctive Ringing takes precedence. If EDCS is activated, DID treatment may be different. See ["Enhanced DCS" on page 12-55](#).

- **Tie Trunk Access**

On DEFINITY ECS, tie trunk groups can be administered as either internal or external tie trunk groups. Calls from internal tie trunk groups are treated as terminal-originated calls and receive one-burst ringing. Calls from external tie trunk groups are treated as externally originated calls and receive two-burst ringing.

## 12 Private Networking

### DCS feature considerations

Page 12-64

- The following distinctive ringing features cannot be provided between nodes in a DCS:
  - Intercom — Automatic
  - Intercom — Dial
  - Manual Signaling

### DCS LWC interactions

- DCS Multi-appearance Conference/Transfer

Activation of LWC is denied after a DCS call has been conferenced or transferred.
- DCS Call Forwarding

If the forwarding extension and the designated extension are at different nodes, LWC cannot be activated at the designated extension for a forwarded call.

### DCS Multiappearance Conference/Transfer interactions

- Voice Terminal Display

No display transparency is provided for DCS Multi-Appearance Conference/Transfer.
- EDCS

On calls to or from Public Network Trunks, calling/called party restrictions are checked when EDCS is active.

### DCS Over ISDN-PRI D-channel interactions

- ASAI

For incoming calls on DCS over ISDN-PRI, ASAI applications receive the ISDN-PRI Calling Party Information, not the DCS Calling Party Information.
- Attendant DXS with Busy Lamp Field

An attempt by the attendant to directly select an extension that has been previously administered as belonging to a administered NCA-TSC results in intercept tone being received.
- CDR

CDR records both the status and the utilization of TSCs. Both CA-TSCs and NCA-TSCs can be recorded. For more information, consult the CDR description in this manual or the CDR manual.
- D-channel Backup

In the event of a D-channel switchover (primary to secondary or secondary back to primary) in a private network, administered NCA-TSCs that were active are assumed to have remained active. Any unacknowledged user-user service requests are assumed to be rejected,



## 12 Private Networking

### DCS feature considerations

Page 12-65

and administered NCA-TSCs which were in the process of being established at the time of the switchover are dropped when the switchover occurs. Those administered NCA-TSCs that were dropped are reattempted again.

If a D-channel switchover occurs on a D-channel going to the public network then all TSCs are dropped. A maintenance-provided "heartbeat" message periodically is sent over each permanent administered NCA-TSC to ensure that such a situation is detected and recovered from.

- Distributed Communications System AUDIX (DCS AUDIX)

The DCS over ISDN-PRI D-channel feature can be used to support DCS AUDIX. (The connection between G3si and AUDIX should be BX.25.)

- GRS

GRS selects TSC compatible facilities when routing NCA-TSCs. In other words, a NCA-TSC request can only select a routing preference that supports TSCs.

In a tandem node, GRS first selects facilities that support TSCs if the call falls into any one of the following two conditions:

- It requests a CA-TSC explicitly
- It contains a DCS information element in the SETUP message

Once a trunk group with available members is selected, the call proceeds even if all the TSCs belonging to the associated signaling group are active. In other words, the completion of a call is given priority over DCS transparency.

- ISDN-PRI

This feature uses ISDN-PRI call control protocol and messages.

- SDN

The DCS over ISDN-PRI D-channel feature allows the system to access public networks such as SDN. SDN supports all DCS features except for the following:

- DCS Attendant Control of Trunk Group Access
- DCS Attendant Direct Trunk Group Selection
- DCS Busy Verification of Terminals and Trunks

- Voice Terminals

An attempt to dial an extension that has been previously administered as belonging to an administered NCA-TSC results in intercept tone being received.

### **DCS Trunk Group Busy/Warning Indication interactions**

- **Loudspeaker Paging Access**

If Trunk Hundreds Select buttons are assigned for Loudspeaker Paging Access zones, Trunk Group Busy Indicators provide a visual indication of the busy or idle status of the zones at the remote location as well as at the local node.

### **Enhanced DCS interactions**

- **Class of Restriction**

When a call goes to coverage, it is the called party's (not the covering party's) restrictions that are used.

## Extended Trunk Access

---

Use Extended Trunk Access (ETA) in conjunction with Uniform Dial Plan (UDP) to allow DEFINITY ECS to send any unrecognized number (such as an extension not administered locally) to another switch for analysis and routing. Such unrecognized numbers can be Facility Access Codes, Trunk Access Codes, or extensions that are not in the UDP table. Non-UDP numbers are administered on either the First Digit Table (on the Dial Plan Record form) or the Second Digit Table. They also are not administered on the ETA Call Screening Table. ETA helps you make full use of automatic routing and UDP.

### How to administer ETA

---

#### Required forms

---

| Form  | Field  | Page                   |
|---|--|------------------------|
| Dial Plan Record<br>(First Digit and Second Digit Tables) | <ul style="list-style-type: none"> <li>■ ETA Routing Pattern</li> <li>■ ETA Node Number</li> </ul> | <a href="#">5-99</a>   |
| ETA Call Screening Table                                  | <ul style="list-style-type: none"> <li>■ Call Screening Entry</li> </ul>                           | <a href="#">12-113</a> |

#### CAUTION:

*Switches can be chained together using ETA. However, you must ensure that switches do not route in a circular ETA call setup. Switch A can route to switch B, and switch B can route to switch C. But, if switch A routes to switch B and switch B routes to switch A, you create a circular ETA call setup.*

### Detailed description

---

Historically, ETA has been used by satellite switches to access stations, trunks, and features at the main switch. ETA frees you from having to enumerate the entire dial plan for the main or satellite complex. Calls that would get intercept treatment without ETA are routed to a remote switch to be reprocessed. The following processing takes place when ETA is administered:

- ETA call is identified because it fails all other routing possibilities.
- The dialed string is not in the ETA Call Screening Table.
- An available route pattern is selected based on the Dial Plan form ETA Routing Pattern or ETA Node Number entries.
- The dialed string is sent to the remote switch.

## Examples of ETA administration

### CASE #1

- ETA Route Pattern — Not administered
- ETA Node Number — Not administered

In this case, ETA is not active. It is not used to route undefined dialed strings.

### CASE #2

- ETA Route Pattern — Administered
- ETA Node Number — Not administered

In this case, the ETA Route Pattern routes undefined dialed strings. However, since an ETA Node Number is not specified, non-call-related DCS messages are not routed.

### CASE #3

- ETA Route Pattern — Not administered
- ETA Node Number — Administered

In this case, the ETA Node Number provides the route pattern. Non-call-related DCS messages also can route since a node number is supplied.

### CASE #4

- ETA Route Pattern — Administered
- ETA Node Number — Administered

In this case, the ETA Route Pattern routes undefined dialed strings while the ETA Node Number routes DCS messages. Nodes themselves do not have to be administered for ETA. ETA should not be used over tandem-tie trunks.

## Interactions

- Abbreviated Dialing  
Abbreviated Dialing calls are routed via ETA.
- Attendant  
Attendants calls are routed via ETA.
- Data-Call Setup  
Analog and digital endpoints can access ETA. The digit string goes to the remote switch like any other digit string is sent. The remote switch handles the data-call setup from that point forward.

- Facility Restriction Levels

It is possible to restrict trunks that are being used in conjunction with ETA by assigning FRLs.

- Last Number Dialed

If a number is routed via ETA to a remote switch and you want to reaccess that number, then reaccess uses ETA.

- Modem Pooling

Modems in Modem Pools are treated like all other trunks.

- Remote Access

Remote-access trunks are able to access the ETA feature just as any other trunk or station does.

## Extension Number Portability

Extension Number Portability (ENP) gives you the ability to assign any extension to any switch in an ENP subnetwork. Stations can be moved across switches while retaining the original extension number, as long as the switches are part of the ENP subnetwork. ENP is used in conjunction with Automatic Alternate Routing (AAR) and Uniform Dial Plan (UDP).

### How to administer ENP

#### Required forms

| Form  | Field      | Page                   |
|---|------------|------------------------|
| AAR and ARS Digit Conversion Table          | ■ All      | <a href="#">8-63</a>   |
| Extension Number Portability Numbering Plan | ■ All      | <a href="#">12-115</a> |
| Node Number Routing                         | ■ All      | <a href="#">12-119</a> |
| Uniform Dialing Plan                        | ■ Ext Code | <a href="#">12-121</a> |

- AAR Digit Conversion form — Assign all 3-digit ENP codes as home, and if using a 5-digit UDP, associate the ENP codes with the leading, or 10 thousands, digit (that is, the fifth digit of the extension). For example, for extension number 73446, “7” is the 10 thousands digit.
- ENP Numbering Plan form — Associate the leading one or two digits of extensions in the ENP subnetwork with a 3-digit ENP code, used to construct a 7-digit AAR-like ENP number.
- Node Number Routing form — Associate a route pattern with each node in the ENP subnetwork.
- Uniform Dialing Plan form — Enter the number of digits in the plan (4 or 5) and the Extension Codes for non-home extensions in the ENP subnetwork as ENPNode (node number routed).

### Detailed description

The ENP Numbering Plan allows you to set 4- or 5-digit extensions in the ENP subnetwork to a 7-digit AAR-like number that is sent to other nodes in the network. Only the first 1 or 2 leading digits of the extension are significant.

ENP Codes are distinguished from AAR location codes because ENP Codes are home on every node within the ENP subnetwork, and ENP Codes are administered in the ENP Numbering Plan table as well as in the AAR Analysis table. Since ENP Codes are home on every node, they cannot be used as AAR location codes.

## 12 Private Networking

### *Extension Number Portability*

Page 12-71

UDP extensions are converted to ENP numbers if node number routing is specified for the extensions in88

the UDP table.



**NOTE:**

One ENP code is required for a 4-digit ENP subnetwork. A 5-digit UDP requires one ENP code for each leading digit of extensions used within the ENP subnetwork.

DCS message signaling links are not required to support ENP. As a result, many multiple switch configurations are possible with ENP. Typically the ENP network will be a subnetwork of a UDP or Electronic Tandem Network (ETN).

## **Interactions**

---

- **Distributed Communications System**

If you use DCS, the ENP node numbers must correspond to DCS node numbers.

## Inter-PBX Attendant Service

---

Inter-PBX Attendant Service (IAS) allows attendants for multiple branches to be concentrated at a main location. Incoming trunk calls to the branch, as well as attendant-seeking voice-terminal calls, route over tie trunks to the main location.

### How to administer Inter-PBX Attendant Service

---

#### Required forms

---

| Form                        | Field   | Page                  |
|-----------------------------|---|-----------------------|
| Tie Trunk Group (Main)      | ■ Incoming Destination  | <a href="#">7-262</a> |
| Console Parameters (Branch) | ■ IAS (Branch)<br>■ IAS Tie Trunk Group No.<br>■ IAS Att. Access Code | <a href="#">5-86</a>  |
| Tie trunk group (Branch)    | ■ All   | <a href="#">7-262</a> |

### Detailed description

---

Inter-PBX Attendant Service calls are incoming tie-trunk calls from a branch location to the main-location attendant group. If no attendant in the group is immediately available, the calls are queued. When an attendant becomes available, the call routes to that attendant. Extended calls are treated as incoming calls to the main location.

DEFINITY ECS can be a branch or main location. Users at each branch can access other branch locations through the main location. A branch can have local attendants. You access these local attendants using Individual Attendant Access.

### Interactions

---

- Attendant Control of Trunk-Group Access  
If a call at a branch attempts to access a controlled trunk group, the call routes to a branch attendant, if there is one. If there is no branch attendant, the call routes to the attendant group at the main location.
- Attendant Display and DCS Attendant Display  
In a DCS environment, an incoming call from a branch displays at the attendant console at the main location as a local call.  
In a non-DCS environment, an incoming call displays at the attendant console at the main location as an incoming tie-trunk call.



## 12 Private Networking

### *Inter-PBX Attendant Service*

Page 12-73

- **Attendant Recall**

If an attendant at the main location holds a call, the calling parties at the branch cannot recall the attendant.

- **Call Coverage**

A call redirected to a coverage path with the attendant group as a coverage point skips that coverage point. It goes to the next coverage point at the branch, if administered, or continues to ring at the previous coverage point. If the attendant group 0 is the only coverage point, it continues to ring at the principal's extension.

- **Centralized Attendant Service**

CAS and Inter-PBX attendant calling cannot be used at the same time.

- **Dial Access to Attendant**

Administer Dial Access to Attendant via the dial platform to the same digit on both the IAS main switch and the IAS branch switch. On the branch switch, administer the PBX attendant access code (Console Parameters form) to match the main PBX attendant-group dial access code.

- **Electronic Tandem Network**

Inter-PBX Attendant Calls can be used within an ETN. The attendant group for the network can be located at the main switch and serve other tandem switches connected by tie trunks.

- **Night Service**

Inter-PBX Attendant Calls deactivates when a branch goes into night service, and reactivates when the branch comes out of night service.

## Node Number Routing

---

Use Node Number Routing (NNR) to specify the route pattern associated with each node in a private network. NNR is a required capability for Extension Number Portability (ENP) and is used in conjunction with Automatic Route Selection (ARS), AAR and ARS Partitioning, Private Networking, and Uniform Dial Plan (UDP). UDP extensions can be routed to a specified node using its associated pattern. NNR allows a UDP route pattern based on node numbers or on location codes. On the AAR and ARS Digit Analysis Tables, you also can specify a Node Number instead of a Route Pattern.

### How to administer NNR

---

#### Required forms

---

| Form                | Field | Page                   |
|---------------------|-------|------------------------|
| Node Number Routing | ■ All | <a href="#">12-119</a> |

---

### Interactions

---

None.

## Private Network Access

Use Private Network Access to allow calls to other switching systems in a private network. These calls do not use the public network. They are routed over customer-dedicated facilities.

### How to administer Private Network Access

#### Required forms

| Form                               | Field                                     | Page                   |
|------------------------------------|---|------------------------|
| Trunk Groups                       | ■ All                                     |                        |
| Access                             |   | <a href="#">7-150</a>  |
| APLT                               |   | <a href="#">7-156</a>  |
| ISDN-BRI                           |   | <a href="#">7-198</a>  |
| ISDN-PRI                           |   | <a href="#">7-219</a>  |
| Tandem                             |   | <a href="#">7-257</a>  |
| Class of Restriction               | ■ Advanced Private Line Termination       | <a href="#">5-72</a>   |
| Feature Access Code (FAC)          | ■ Automatic Alternate Routing Access Code | <a href="#">5-113</a>  |
| AAR and ARS Digit Analysis Table   | ■ All                                     | <a href="#">8-54</a>   |
| AAR and ARS Digit Conversion Table | ■ All                                     | <a href="#">8-63</a>   |
| Node Number Routing                | ■ All                                     | <a href="#">12-119</a> |
| Station                            | ■ COR                                     | <a href="#">6-28</a>   |

- Trunk Group Forms — Set `Group Type` to **access**, **aplt**, **tandem**, **tie**, or **isdn** and `Service Type` to **access**, **tie**, or **tandem**. Complete COR digit treatment and common type fields for tie trunk groups associated with a private network.

### Detailed description

Private networks can include:

- Common-control switching arrangement (CCSA)
- Distributed Communications Systems (DCS) and Enhanced DCS (EDCS)
- Electronic tandem network (ETN)
- Enhanced private-switched communications service (EPSCS)
- Tandem-tie-trunk network (TTTN)
- Italian Traslatore Giunzione Uscente/Entrante/Interno (TGU/TGE/TGI) trunks

Unless prohibited by the COR, all incoming private network trunks, except CCSA, can access outgoing trunks without attendant or terminal-user assistance. All incoming CCSA calls must route to an attendant or a terminal user.

When off-network calling is part of the CCSA and EPSCS, long-distance calls route as far as possible over these networks before terminating on the public network. Thus, charges for toll calls are reduced. The COR you administer to individual system users determines whether access to this capability is allowed or denied.

In Italy, TGU/TGE/TGI trunks provide private network access between 2 switching systems. They also provide some feature transparency for COR (Inward Restriction), DID (when reaching busy stations), and Intrusion.

## Interactions

---

- Attendant Call Waiting

Call Waiting is provided via Italian TGU/TGE (main and satellite) trunks. Call Waiting also is provided in Italy and all other countries through DCS.

- Attendant Intrusion

Attendant Intrusion is provided on satellite switches via TGU/TGE trunks. Attendant Intrusion also is provided through DCS.

## QSIG

---

QSIG provides compliance to the International Organization for Standardization (ISO) Integrated Services Digital Network private-networking specifications. QSIG is defined by ISO as the worldwide standard for private networks.

QSIG is the generic name for a family of signaling protocols. The Q-reference point or interface is the logical point where signaling is passed between two peer entities in a private network. QSIG signaling provides feature transparency in a single-vendor or multi-vendor environment.

QSIG provides call-related supplementary services. These are services that provide features in addition to voice or data connectivity and number transport and display. Examples of supplementary services include Name Identification, Call Forwarding (Diversion), and Call Transfer.

DEFINITY ECS provides three levels of QSIG functionality:

- Basic Call Setup — Supports basic call setup and number transport
- Basic Supplementary Services — Supports Name Identification Services, Call Forwarding (Diversion), and Call Transfer
- Supplementary Services with Rerouting — Supports Call Forwarding (Diversion) with Reroute (using Path Replacement) and Call Transfer with Reroute (using Path Replacement)

### How to administer QSIG

---

DEFINITY ECS supports QSIG over both ISDN-PRI trunks (using the DS1 circuit pack) and ISDN-BRI trunks (using the ISDN-BRI trunk circuit pack).

#### Required forms for Basic Call Setup

---

| Form                                  | Field              | Page                  |
|---------------------------------------|--------------------|-----------------------|
| DS1 Circuit Pack (for ISDN-PRI only)  | ■ Connect          | <a href="#">7-79</a>  |
|                                       | ■ Interface        |                       |
|                                       | ■ Peer Protocol    |                       |
|                                       | ■ Signaling Mode   |                       |
| ISDN-BRI Circuit Pack                 | ■ All              | <a href="#">5-186</a> |
| ISDN-BRI Trunk Group                  | ■ Group Type       | <a href="#">7-198</a> |
| ISDN-PRI Trunk Group                  | ■ Group Type       | <a href="#">7-219</a> |
| System Parameters<br>Customer-Options | ■ ISDN             | <a href="#">5-277</a> |
|                                       | ■ Basic Call Setup |                       |

---

- DS1 Circuit Pack form — Set Connect to **pbx**, Interface to **peer-master** or **peer-slave**, Peer Protocol to **q-sig**, and Signaling Mode to **isdn-pri** or **isdn-ext**, as required.

### Required forms for Basic Supplementary Services

| Form                                  | Field                            | Page                  |
|---------------------------------------|----------------------------------|-----------------------|
| System Parameters<br>Customer-Options | ■ ISDN                           | <a href="#">5-277</a> |
|                                       | ■ Basic Supplementary Services   |                       |
| ISDN-BRI Trunk Group                  | ■ Group Type                     | <a href="#">7-198</a> |
|                                       | ■ Supplementary Service Protocol |                       |
| ISDN-PRI Trunk Group                  | ■ Group Type                     | <a href="#">7-219</a> |
|                                       | ■ Supplementary Service Protocol |                       |

## Supplementary Services

### Required forms for Supplementary Services with Rerouting

| Form                                  | Field                                   | Page                  |
|---------------------------------------|---|-----------------------|
| System Parameters<br>Customer-Options | ■ ISDN                                  | <a href="#">5-277</a> |
|                                       | ■ Basic Supplementary Services          |                       |
|                                       | ■ Supplementary Services with Rerouting |                       |
| ISDN-BRI Trunk Group                  | ■ Group Type                            | <a href="#">7-198</a> |
|                                       | ■ Supplementary Service Protocol        |                       |
| ISDN-PRI Trunk Group                  | ■ Group Type                            | <a href="#">7-219</a> |
|                                       | ■ Supplementary Service Protocol        |                       |
| ISDN Numbering -<br>Private           | ■ All                                   | <a href="#">7-93</a>  |

- DEFINITY ECS provides QSIG in addition to some national public network protocols and the European Telecommunications Standards Institute (ETSI) protocols for supplementary services. *The protocols are mutually exclusive.* On the Trunk Group form, set the Group Type to **isdn** and one of the following Supplementary Service Protocols. For a more complete list of options, see Supplementary Service Protocol on page [7-207](#) for ISDN-BRI trunks and page [7-231](#) for ISDN-PRI trunks.

- b ISO/ETSI QSIG Private Network
- d European Computer Manufacturer's Association (ECMA) QSIG private network (supports only Name Identification and Additional Network Feature Transit Counter (ANF-TC))

## Additional Network Features

DEFINITY ECS also includes QSIG Additional Network Feature (ANF) capability. ANFs are used for networking; they operate behind the scene. You are not always aware that DEFINITY ECS is using them. They provide services in addition to the basic call. DEFINITY ECS includes the following ANFs: Transit Counter (ANF-TC) and Path Replacement (ANF-PR). Path Replacement is a mechanism used for routing.

### Detailed description

QSIG signaling protocols are based on ITU-T (formerly CCITT) Q.931 access protocols across the Q-reference point. QSIG standards are also supported by the ISDN Private Networking Specification (IPNS) Forum. DEFINITY ECS QSIG complies with a number of international regulations. For example, QSIG:

- Complies with ISO standard 11572 for layer 3 to support private-network connectivity.
- Meets requirements for the ISO Private Network Generic Functional Procedures (ISO standard 11582) for call-related supplementary services.
- Supports call-related supplementary service transport, Abstract Syntax Notation 1 (ASN.1)/Basic Encoding Rules (BER), and Remote Operation Service Element (ROSE) services/protocols.
- Provides the Name and Number Identification supplementary service as defined by ISO Standards 13864, 13868, and 11572.
- Provides Call Forwarding (Diversion) as defined by ISO Standards 13872 and 13873.
- Provides Call Transfer as defined by ISO Standards 13865 and 13869.

A Temporary Signaling Connection (TSC) provides a temporary signaling path through ISDN switches for exchanging supplementary service information on ISDN-PRI D-channels. There is no B-channel related to the connection; no data or voice transmissions take place.

There are two types of temporary signaling connections:

- Call Associated (CA-TSC)
- Non-Call Associated (NCA-TSC)

A CA-TSC refers to a service for exchanging USER INFORMATION messages associated with an ISDN B-channel connection by the call reference value of the call control data packets. On DEFINITY ECS, this type of TSC is used only for DCS features on ISDN-PRI Signaling Groups administered with Supplementary Service Protocol a.

An NCA-TSC is a connection not related with any ISDN B-channel connections. DEFINITY ECS supports two types of NCA-TSC that conform to two different protocol standards:

- The AT&T type of NCA-TSC is used for the DCS over ISDN-PRI D-channel and DCS AUDIX applications. Only ISDN-PRI Signaling Groups administered with Supplementary Service Protocol support AT&T NCA-TSCs. For further information, see [“AT&T NCA-TSC” on page 12-49](#).
- The QSIG type of NCA-TSC is used for certain QSIG features such as Call Completion (Automatic Call Back). This type of NCA-TSC is referred to in the QSIG protocol standards as a Call-Independent Signaling Connection (CISC). Only ISDN-PRI Signaling Groups administered with Supplementary Service Protocol support QSIG NCA-TSCs.

## QSIG NCA-TSC

Used to exchange Facility Information Elements in call control messages, FACILITY messages, or a combination of both. NCA-TSC is not administered ahead of time, but is invoked dynamically by the QSIG feature that needs it. Some QSIG features remove the NCA-TSC when it is no longer needed; others leave the NCA-TSC active for a longer period of time.

DEFINITY ECS does not provide gateway functionality between a QSIG NCA-TSC and an AT&T NCA-TSC. For example, although a call can be routed from a DCS network into a QSIG network, it is not possible for the caller in this case to invoke an automatic callback.

## Called Name

Enables the calling party to see the name of the called party while the call is ringing at the called party's terminal. Called Name is similar to the display provided for local on-switch calls, as well as for the DCS calls, with the following exceptions:

- Names longer than 15 characters are truncated; only the first 15 characters display.
- The number never displays.

## Busy Name

Enables the calling party to see the name of the called party while listening to a busy tone because the called party's terminal was busy. Busy Name is similar to the display provided for local on-switch calls, as well as for DCS calls, with the exceptions noted for Called Name.

## QSIG Path Retention

Path Retention is a generic mechanism that can be used by supplementary services during call establishment.

The Originating PBX invokes path retention for one supplementary service or for several simultaneous supplementary services. Invoking a particular supplementary service means retaining the network connection if the Terminating



PBX encounters the appropriate conditions. The Originating PBX is informed of the reason for retaining the connection. It then decides (for example, by consulting the calling user) whether to invoke the supplementary service. Under some circumstances in which the network connection is retained, more than one of the supplementary services for which path retention has been invoked may be applicable.

Successive retentions of the network connection by the Terminating PBX following a single path-retention invocation by the Originating PBX are possible. This is a result of different conditions being encountered at the Terminating PBX. When an attempt is made to invoke a supplementary service for which the network connection has been retained, a further condition can be encountered that can cause the network connection to be retained again for the same or a different supplementary service.

Path retention is specified in terms of a Path Retention entity existing within the Coordination Function at the Originating PBX and at the Terminating PBX.

## QSIG Call Forwarding (Diversion)

---

QSIG Call Forwarding (Diversion) is based on the DEFINITY ECS Call Forwarding feature. It extends the feature transparency aspects of Call Forwarding over a QSIG trunk.

- If QSIG Call Forwarding Unconditional is activate, all calls are diverted immediately.
- If QSIG Call Forwarding with busy/don't answer is activate and a station is busy, a call is diverted immediately.
- If QSIG Call Forwarding with busy/don't answer is activate and a station is idle but the call is not answered, a call is diverted after a specified number of rings.

These features are activated either by dialing a feature access code or by pressing a button. See [“Call Forwarding” on page 4-224](#) for detailed descriptions of how to use these features.

ANF-PR applies to all QSIG Call Forwarding features. A forwarded call can be rerouted in a private network to find a more cost-effective or resource-efficient path.

QSIG Call Forwarding (Diversion) provides additional call information to both the caller and the diverted-to station above what is provided if the call is forwarded over a trunk that is not administered for QSIG Supplementary Service Protocol b. The caller sees “forward” on the display when a call is forwarded. The diverted-to user receives information that the call has been forwarded with the redirection symbol “f.” Depending upon QSIG Name and Number Identification Services administration, the originator can see the connected party's name or number followed by “forward.” The diverted-to user can see the originator's identification (name or number) and the diverting user's (called party) identification (name or number) followed by “f.”

When a call has already been forwarded 3 times over a QSIG trunk, it is not forwarded again but instead terminates at the final forwarded-to terminal. Remote activation and deactivation of this feature are not supported.

Because QSIG Call Forwarding (Diversion) is compatible with the ISO QSIG standards, DEFINITY ECS provides feature transparency for Call Forwarding with any switch that follows these standards.

If an incoming QSIG call is forwarded to another extension, the Called Name sent in ALERTING or DISCONNECT is the name of the forwarding extension. If the original Called Name is not available, the Redirecting Name is available, the Redirecting Name is sent instead. This applies to Call Forward All Calls and Call Forward Busy/Don't Answer.

## How to administer QSIG Call Forwarding (Diversion)

---

### Required forms

| Form                                  | Field   | Page                  |
|---------------------------------------|---|-----------------------|
| System Parameters<br>Customer-Options | ■ QSIG Basic Supplementary Services (for Call Forwarding without rerouting)       | <a href="#">5-277</a> |
|                                       | ■ QSIG Supplementary Services with Rerouting (for Call Forwarding with rerouting) |                       |
|                                       | ■ Restrict Call Forward Off Net   |                       |
| Class of Service                      | ■ Restrict Call Forward Off Net   | <a href="#">5-81</a>  |
| ISDN-BRI Trunk<br>Group               | ■ Group Type  | <a href="#">7-198</a> |
|                                       | ■ Supplementary Service Protocol  |                       |
|                                       | ■ Disconnect Supervision  |                       |
| ISDN-PRI Trunk<br>Group               | ■ Group Type  | <a href="#">7-219</a> |
|                                       | ■ Supplementary Service Protocol  |                       |
|                                       | ■ Disconnect Supervision  |                       |

 **NOTE:**

The QSIG b and d protocols are not allowed with DCS.

## QSIG Call Transfer

---

QSIG Call Transfer is based on the current DEFINITY ECS Transfer and Trunk-to-Trunk Transfer features. QSIG Transfer signaling occurs as long as one of the calls involves a QSIG trunk between the two switches.

Once a call is transferred, the transferring switch is unnecessary. Additional Network Feature-Path Replacement (ANF-PR) is invoked automatically to connect the transferred call more efficiently in the private network. QSIG Call Transfer attempts to connect the two parties more efficiently and drops the unnecessary switches.

When you use this feature, you see no difference between QSIG Call Transfer and the standard DEFINITY ECS Transfer or Trunk-to-Trunk Transfer features. See the basic features: [“Transfer” on page 4-597](#) and [“Transfer — Outgoing Trunk to Outgoing Trunk” on page 4-599](#).

QSIG Call Transfer differs from standard DEFINITY ECS Transfer in that additional call information is available for the connected parties after the transfer completes.

Depending upon QSIG Identification Services administration, the connected parties' displays show each other's name and/or number. If the name and number are not available, the display of a connected party updates with the name of the involved trunk group.

## How to administer QSIG Call Transfer

### Required forms

| Form                                  | Field   | Page                  |
|---------------------------------------|---|-----------------------|
| System Parameters<br>Customer-Options | <ul style="list-style-type: none"><li>■ QSIG Basic Supplementary Services (for Call Transfer without rerouting)</li><li>■ QSIG Supplementary Services with Rerouting (for Call Transfer with rerouting)</li></ul> | <a href="#">5-277</a> |
| Feature-Related<br>System Parameters  | <ul style="list-style-type: none"><li>■ Trunk-to-Trunk Transfer</li></ul>   | <a href="#">5-123</a> |
| ISDN-BRI trunk group                  | <ul style="list-style-type: none"><li>■ Group Type</li><li>■ Supplementary Service Protocol</li><li>■ Disconnect Supervision</li></ul>  | <a href="#">7-198</a> |
| ISDN-PRI trunk group                  | <ul style="list-style-type: none"><li>■ Group Type</li><li>■ Supplementary Service Protocol</li><li>■ Disconnect Supervision</li></ul>  | <a href="#">7-219</a> |

### NOTE:

Unless QSIG Name and Number Identification is also administered, name and number information do not display when a call is transferred. Also, DCS does not allow the QSIG b and d protocols.

## QSIG Name and Number Identification

---

QSIG Name and Number Identification allows a switch to send and receive the calling number, calling name, connected number, and connected name. Additional parameters that control the display of the connected name and number are administered on the Feature-Related System-Parameters form.

You can administer “yes”, “no”, or “restricted.” Restricted means that DEFINITY ECS sends the information but sends it “presentation restricted,” which indicates to the receiving switch that the information should not be displayed. A received restricted name or number is included on the Call Detail Record (CDR). Due to current networking limitations, a received Restricted Calling Party Number displays. However, a received Restricted Connected Party Number or Calling/Connected Name is *not* displayed.

QSIG Name and Number Identification displays up to 15 characters for the calling and connected name and up to 15 digits for the calling and connected number across ISDN interfaces.

### Transit switch information

When DEFINITY ECS acts as a transit switch, the QSIG standards require it to pass on all supplementary service information that is not addressed to it. This includes name information. (A “transit” switch is a switch that routes an incoming call administered for Supplementary Services Protocol B to a trunk also administered for Supplementary Services Protocol B.) However, Basic Call Setup and number information is subject to modification by the transit switch. This means that trunk group administration on a transit switch does not override incoming name information, but may override incoming number information (as long as this does not lower the restriction on the information).

**Example.** If a non-restricted calling name and number are received by a DEFINITY ECS acting as a transit switch, and if the outgoing trunk is administered for presentation restricted for both name and number, the number is passed on as “restricted” and name is passed on as “unrestricted.”

### Tandem switch information

However, in the case of tandemed calls (calls involving two ISDN trunks that are not both administered for Supplementary Service Protocol B), trunk group administration may override both incoming name and number information, as long as doing so does not lower the restriction on the information. For example, a tandemed call that comes in with restricted name information is sent out with restricted name information even if the outgoing trunk is administered for presentation unrestricted. However, non-restricted data is sent restricted if the trunk group administration is set for “presentation restricted.”

## ISDN numbering formats

The ability to send calling name, connected number, and calling number, or to restrict their display, is administered on the ISDN Trunk Group form. The ISDN system parameters are administered on the Feature-Related System-Parameters form. Numbering is specified on the ISDN Public-Unknown-Numbering and/or ISDN Private-Numbering forms. The numbering form you use depends on how you administer the ISDN trunk group Numbering Format field.

- On the ISDN trunk group form, if you set `Numbering Format` to one of the public or unknown numbering formats, use the ISDN Public-Unknown-Numbering form.
- On the ISDN trunk group form, if you set `Numbering Format` to one of the private numbering formats, use the ISDN Private-Numbering form.

However, there is an exception. If the Called Party Number is formatted with the public numbering format, the Calling/Connected Party Number is created in the public format even if “private” is specified on the ISDN trunk group form. This provides the caller or called party a number that can be used to reach the other party. Since the call routes through the public network, the public Calling/Connected Party Number is a more accurate address.

## Called/Busy Name Display

A QSIG Called Name or Busy Name displays on the calling party's display as soon as the ALERTING or DISCONNECT message has been received. The display format matches exactly the format used to display a QSIG Connected Name. If the name received in ALERTING or DISCONNECT is longer than 15 characters, the leftmost 15 characters display.

If a CONNECT message is received while a QSIG Called Name displays, and if the CONNECT contains a Connected Name and/or Number, DEFINITY ECS updates the calling station display with the connected information. If no Connected Name or Number is received, the displays continues to show the Called Name (and Called Number, if applicable).

## **How to administer QSIG Name and Number Identification**

---

### **Required forms**

| <b>Form</b>                           | <b>Field</b>   | <b>Page</b>           |
|---------------------------------------|--|-----------------------|
| System Parameters<br>Customer-Options | ■ QSIG Basic Call Setup (for Calling Number)           | <a href="#">5-277</a> |
|                                       | ■ QSIG Basic Supplementary Services (for Calling Name) |                       |
| DS1 Circuit Pack                      | ■ All  | <a href="#">7-79</a>  |
| Hunt Group                            | ■ Group Name   | <a href="#">5-158</a> |
|                                       | ■ Ext  |                       |
|                                       | ■ Member Name  |                       |
|                                       | ■ ISDN Caller Disp                                     |                       |
| ISDN Numbering —<br>Public/Unknown    | ■ All  | <a href="#">7-95</a>  |
| ISDN Numbering —<br>Private           | ■ All  | <a href="#">7-93</a>  |
| Station                               | Name   | <a href="#">6-28</a>  |
| Terminating<br>Extension Group        | ■ Group Name   | <a href="#">5-295</a> |
|                                       | ■ Ext  |                       |
|                                       | ■ ISDN Caller Disp                                     |                       |

*Continued on next page*



**Required forms — Continued**

---

| <b>Form</b>                       | <b>Field</b>                      | <b>Page</b>           |
|-----------------------------------|-----------------------------------|-----------------------|
| ISDN-BRI trunk group              | ■ Outgoing Display                | <a href="#">7-198</a> |
|                                   | ■ Send Calling Number             |                       |
|                                   | ■ Send Connected Number Send Name |                       |
|                                   | ■ Supplementary Service Protocol  |                       |
|                                   | ■ Numbering Format                |                       |
| ISDN-PRI trunk group              | ■ Outgoing Display                | <a href="#">7-219</a> |
|                                   | ■ Send Calling Number             |                       |
|                                   | ■ Send Connected Number Send Name |                       |
|                                   | ■ Supplementary Service Protocol  |                       |
|                                   | ■ Numbering Format                |                       |
| Feature-Related System Parameters | ■ Trunk-to-Trunk Transfer         | <a href="#">5-123</a> |

---

 **NOTE:**

The QSIG b and d protocols are not allowed with DCS.

## QSIG Path Replacement (ANF-PR)

---

DEFINITY ECS provides QSIG Additional Network Feature Path Replacement (ANF-PR) as defined in ISO/IEC 13863 and 13874. With this feature, a call's connections between switches in a private network can be replaced with new connections while the call is active.

ANF-PR is invoked when a call is transferred and improvements may be made in the routes. For example, after a call is transferred, the two parties on the transferred call can be connected directly and the unnecessary trunks are dropped off the call. The routing administered at the endpoints allows for a more efficient route connection. See ["QSIG Call Transfer" on page 12-84](#) for more information.

ANF-PR selects the best route based on the preference assigned to routes in the Route Pattern form. Least cost Supplementary Service B (SSB) routes must be first, followed by more expensive routes.

### NOTE:

When routes to SSB trunks are included with routes to non-SSB trunks, SSB trunks must appear first on the Route Pattern form. This is because as soon as ANF-PR encounters a non-SSB trunk in the route pattern, it stops looking.

Class of Restriction (COR) and Facility Restriction Levels (FRL) are adhered to in routing calls. ANF-PR is not invoked on data calls because there is a period of time when information can be lost.

## How to administer QSIG Path Replacement

---

### Required forms

---

| Form                                  | Field                                   | Page                  |
|---------------------------------------|---|-----------------------|
| System Parameters<br>Customer-Options | ■ QSIG Basic Supplementary Services     | <a href="#">5-277</a> |
|                                       | ■ Supplementary Services with Rerouting |                       |
| ISDN-BRI trunk<br>group               | ■ Group Type                            | <a href="#">7-198</a> |
|                                       | ■ Supplementary Service Protocol        |                       |
| ISDN-PRI trunk<br>group               | ■ Group Type                            | <a href="#">7-219</a> |
|                                       | ■ Supplementary Service Protocol        |                       |

---

## QSIG Supplementary Service - Call Completion

---

Use this feature to provide QSIG Supplementary Service - Call Completion (SS-CC).

### How to administer QSIG Supplementary Service - Call Completion

---

#### Required forms

| Form                               | Field   | Page                  |
|------------------------------------|---|-----------------------|
| Signaling Group                    | ■ Supplementary Service Protocol                          | <a href="#">7-106</a> |
|                                    | ■ Max Number of NCA TSC                                   |                       |
| Route Pattern                      | ■ TSC   | <a href="#">8-67</a>  |
| Feature-Related System Parameters  | ■ QSIG TSC Extension                                      | <a href="#">5-123</a> |
|                                    | ■ Automatic Callback - No Answer Timeout Interval (rings) |                       |
| Feature Access Code                | ■ Automatic Callback Activation and Deactivation          | <a href="#">5-113</a> |
| Station                            | ■ Button/Feature Button Assignments - Auto-cback          | <a href="#">6-28</a>  |
| Class of Service                   | ■ Auto Callback   | <a href="#">5-81</a>  |
| System-Parameters Customer-Options | ■ ISDN-PRI  | <a href="#">5-277</a> |
|                                    | ■ Basic Supplementary Services                            |                       |
|                                    | ■ Basic Call Setup  |                       |
| Trunk group                        | ■ Supplementary Service Protocol                          | <a href="#">7-198</a> |
|                                    | ■ NCA-TSC Trunk Member                                    | <a href="#">7-219</a> |

For voice terminals, administer the following:

- For the Signaling Group form, set `Supplementary Service Protocol` to **b** and `Max Number of NCA TSC` to greater than 0.
- For the Feature-Related System Parameters form, set `QSIG TSC Extension` to the dedicated number for QSIG calls.
- For the Trunk Group form, set `Supplementary Service Protocol` to **b**.
- For the Route Pattern form, set `TSC` to **y** (only if the PBX is a transit node for QSIG CISC).

For digital voice terminals, you also must use the Station form, and administer for Automatic Callback button.

## Detailed description

---

The Supplementary Service - Completion of Calls to Busy Subscribers (SS-CCBS) and Supplementary Service - Completion of Calls on No Reply (SS-CCNR) are the equivalent QSIG features of Automatic Callback On Busy and Automatic Callback on No Answer, respectively.

SS-CCBS and SS-CCNR allow any QSIG network voice user who placed a call to a busy or unanswered voice terminal over the QSIG network to be called back automatically when the called voice terminal becomes available.

An analog voice terminal user activates SS-CCBS or SS-CCNR by pressing the Recall button or flashing the switchhook and then dialing the Automatic Callback (ACB) Activation feature access code. The type of supplementary service being invoked (CCBS versus CCNR) depends on the busy or unanswered condition of the call. DEFINITY ECS identifies which supplementary service to invoke as a consequence of the ACB activation request. An analog user can activate only one ACB call at any given time.

A multiappearance voice terminal user can activate SS-CCBS or SS-CCNR for the number of ACB buttons assigned to the terminal. After placing a call to a voice terminal over the QSIG network that is busy or not answering, the caller can activate SS-CCBS or SS-CCNR by pressing an idle ACB button. DEFINITY ECS identifies which supplementary service to invoke as a consequence of the ACB activation request.

The requested supplementary service remains activated until the Call Completion performs, or until the Service Duration Timer expires (40 minutes).

When SS-CCBS or SS-CCNR activates towards the busy or not answering station on the terminating PBX, the terminating PBX monitors the called voice terminal. A busy voice terminal becomes available when the user hangs up after completing the current call. An unanswered voice terminal becomes available after being used for another call and then hung up. When the called voice terminal becomes available to receive a call, the terminating PBX notifies the originating PBX to initiate a Call Completion call attempt.

After the called voice terminal at the terminating PBX becomes available and the initiation of the Call Completion call, the calling party at the originating PBX receives a priority ringing callback call. If the calling party lifts the handset, ringing starts at the terminating PBX.

An SS-CCBS or SS-CCNR request cancels at both PBXs for any of the following user-related reasons:

- A successful Call Completion call.

## 12 Private Networking

### QSIG Supplementary Service - Call Completion

Page 12-93

- The called party at the terminating PBX does not become available within 40 minutes.
- The calling party does not answer the priority callback call within the administered interval (2 to 9 ringing cycles).
- The calling party decides not to wait and presses the same ACB button a second time (multiappearance voice terminal) or dials the ACB Cancel feature access code (analog voice terminal).
- The calling party is unable to receive the callback call because it is busy during the attempted priority callback call.
- After the calling party receives the priority callback call, but before alerting the called user at the terminating PBX, the called party becomes busy again.

## Interactions

---

- Adjunct Switch Applications Interface (ASAI)  
ASAI cannot invoke/initiate QSIG-CC.
- Attendant Calling Waiting and Call Waiting Termination  
If you activate QSIG SS-CC to a single line voice terminal, the Attendant Call Waiting and Call Waiting Termination features are denied.
- Attendant Console Group  
You cannot activate QSIG SS-CC toward the attendant console group or towards the individual attendant.
- Attendant Control of Trunk Group Access  
You cannot activate QSIG SS-CC if the call uses a controlled trunk group.
- AUDIX  
You cannot activate QSIG SS-CC towards AUDIX. SS-CC to any transferred-to station is not allowed.
- Automatic Call Distribution (ACD)  
You cannot activate QSIG SS-CC towards a voice terminal after dialing the ACD group extension. It is possible to invoke SS-CC towards a station when dialing the individual's extension number. You can activate SS-CC from any ACD agent.

## 12 Private Networking

### QSIG Supplementary Service - Call Completion

Page 12-94

- **Bridged Call Appearance**

You cannot activate QSIG SS-CC from a bridged call appearance. When a call originates from a primary extension number, the return call notification rings at all bridged call appearances.
- **Call Coverage**

QSIG SS-CC requests are always activated at the principal user and not coverage points. Similar to ACB, QSIG SS-CC Call Completion calls to the called user can redirect to coverage.
- **Call Forwarding**

You cannot activate SS-CCBS or SS-CCNR towards a called station that has Call Forwarding enabled.
- **Call Pickup**

On recall at the originating side, a group member cannot answer a QSIG SS-CC call for another group member.
- **Call Waiting**

Call Waiting is denied when QSIG SS-CC is activated to the single-line voice terminal.
- **Conference and Transfer**

You cannot activate QSIG SS-CC towards a transferred-to party.
- **Hold**

A single-line voice terminal cannot receive a QSIG SS-CC call while it has a call on hold.
- **Hotline Service**

A hotline service cannot request SS-CC.
- **Internal Automatic Answer (IAA)**

If the IAA feature is enabled, QSIG SS-CC calls are not answered automatically.
- **Manual Originating Line Service**

A manual originating service cannot request QSIG SS-CC.
- **Multimedia Endpoints**

You cannot activate QSIG-CC towards multimedia data endpoints.
- **Outgoing Trunk Queueing**

Outgoing Trunk Queueing cannot be invoked after the calling party answers the priority call back call and no trunks are available. The SS-CCBS and SS-CCNR request cancels at both PBXs.

**12 Private Networking**

*QSIG Supplementary Service - Call Completion*

*Page 12-95*

- Termination Extension Group (TEG)

You cannot activate QSIG SS-CC towards a TEG extension, but QSIG-CC requests can be activated towards a single member in the group.

- Uniform Call Distribution and Direct Department Calling

You cannot activate QSIG SS-CC towards a uniform call distribution group or a direct department calling group extension, but you can activate towards a single member in the group.

- Vector Directory Number (VDN)

You cannot activate SS-CC towards a VDN extension.

## QSIG Supplementary Service - Call Offer

---

This feature, on request from the calling user (or on that user's behalf), enables a call to be offered to a busy called user and to wait for that person to accept the call, after the necessary resources have become available.

The busy called user is given an indication of the offered call. During the time that the call is offered, the called user may ignore the offered call or may attempt to make the necessary resources available (for instance, by releasing or placing another call on hold). When and if the necessary resources become available, the call completes as a normal incoming call.

There are four ways of invoking QSIG Supplementary Service - Call Offer (SS-CO). A Private Telecommunication Network (PTN) offers one or more of these ways. They are:

- Network invocation (immediate) — the PTN automatically invokes SS-CO whenever the calling user makes a call to a user that is busy, if required by the service profile of the calling user.
- Consultation — the calling user, on being informed that a call has failed because it is busy at the destination and that SS-CO may be possible, is able, within a defined time period (consultation timer), to request invocation of SS-CO.
- Immediate invocation — the calling user is able to request invocation of SS-CO as part of the initial call set-up.
- Network invocation (delayed) — the network, having informed the calling user that a call has failed because it is busy at the destination, invokes SS-CO automatically unless the calling user initiates call clearing within a defined time period (automatic call offer invocation timer).

DEFINITY ECS supports immediate invocation on outgoing QSIG originations if the originator's Class of Service (COS) is so optioned. DEFINITY ECS supports all of the above for incoming QSIG calls.

SS-CO is considered completed when any of the following occurs:

- The offered call starts alerting
- The offered call is answered
- The calling user releases the offered call
- The terminating end PBX rejects the offered call

When a QSIG Call Offer service terminates, the service is considered successful if one of the following occurs:

- The called user is an Analog set, busy, and *Call Waiting Termination* on the Station form is enabled



## 12 Private Networking

### QSIG Supplementary Service - Call Offer

Page 12-97

- The called user is a Multi Call-appearance set, at least one call-appearance is busy for an active call, and at least one call-appearance is available for incoming calls
- If the call cannot be offered to the original called user due to call deflection (for instance, Send All Calls active, Call Coverage due to “busy” condition), but it can be offered/terminated to another user within the same PBX which satisfies either condition (1) or (2)
- If the called number is a group number (for instance, Hunt group (UCD/DDC), Coverage Answer Group, Attendant group, and so forth) and the offered call can be queued or terminated to one of the group member which satisfies either condition (1) or (2)

The effect of QSIG SS-CO on the terminating end is similar to the DCS Call Waiting feature with the exception that for Call Waiting, the calling side (user or PBX) does not have to convey any special message to invoke the feature. The Call Waiting Termination feature is driven based on the terminating user (for instance, single line analog set user with Call Waiting enabled).

For internal calls (for instance, intra-PBX calls) within DEFINITY for the Call Waiting feature, if Call Waiting is invoked successfully at the called user, the calling user's display (for display equipped terminal) is updated with call progress message “wait” and a special audible ringback tone is provided. For DCS Call Waiting, the calling user is provided with special audible ringback tone but is not provided with a display update. For QSIG Call Offer, DEFINITY takes advantage of the additional information available from the far end, if QSIG Call Offer invokes successfully, and provides similar information to the calling user as the Call Waiting feature provides for on internal calls, with the exception that the display update will be “offered” instead of “wait” to reflect invocation of QSIG Call Offer service.

On successful invocation of the QSIG Call Offer service, the called user receives an indication of the terminated offered call. Currently, DEFINITY provides an administrable tone (one, two, or three bursts) to the called busy user when Call Waiting Termination is invoked. When the QSIG Call Offer service is invoked successfully, DEFINITY provides the following:

- To the busy analog set user, the same tone as Call Waiting Termination feature, or
- To the busy Multi call-appearance set (for instance, at least one call-appearance is busy for an active call and at least one call-appearance is available for incoming calls) user, a normal incoming call tone

For incoming QSIG calls, the QSIG Call Offer service may use path retention which is a generic mechanism to retain the signaling connection so that the originating party can decide whether to invoke the supplementary service. The network connection can be retained for more than one of the supplementary services for which path retention has been invoked.

## How to administer QSIG SS-CO

---

**Table 12-3. Required forms for Basic Call Setup**

| Form                                  | Field   | Page                  |
|---------------------------------------|---|-----------------------|
| Class of Service                      | ■ QSIG Call Offer Originations                                  | <a href="#">5-81</a>  |
| System-Parameters<br>Customer-Options | ■ ISDN<br>■ Basic Call Setup<br>■ Basic Supplementary Services  | <a href="#">5-277</a> |
| DS1 Circuit Pack form                 | ■ Connect<br>■ Interface<br>■ Peer Protocol<br>■ Signaling Mode | <a href="#">7-79</a>  |
| Station                               | ■ Call Waiting Indication                                       | <a href="#">6-28</a>  |

### Detailed description

---

- DS1 Circuit Pack form — Set **Connect** to **pbx**, **Interface** to **peer-master** or **peer-slave**, **Peer Protocol** to **q-sig**, and **Signaling Mode** to **isdn-pri** or **isdn-ext**, as required.
- For outgoing call offer call originations:
  - System Parameters Customer-Option form — on QSIG OPTIONAL FEATURES (page 4), set **Basic Call Setup** to **y** and **Basic Supplementary Services** to **y**.
  - Class of Service form — set **QSIG Call Offer Originations** to **y**.
- For incoming call offer calls to a single line appearance:
  - System Parameters Customer-Option form — on QSIG OPTIONAL FEATURES (page 4), set **Basic Supplementary Services** to **y**.
  - Station form — set **Call Waiting Indication** to **y**.
- For incoming call offer calls to a multiple line appearance:
  - System Parameters Customer-Option form — on QSIG OPTIONAL FEATURES (page 4), set **Basic Supplementary Services** to **y**.

## QSIG Transit Counter (ANF-TC)

DEFINITY ECS provides QSIG ANF-TC as defined in ISO/IEC 6B032 and 6B033. It prevents indefinite looping, connections giving poor transmission performance, and inefficient use of network resources.

ANF-TC is invoked automatically for ISDN basic calls and the Route Pattern form indicates the number of switches through which a call may be routed.

### How to administer QSIG Transit Counter

#### Required forms

| Form                 | Field                            | Page                  |
|----------------------|----------------------------------|-----------------------|
| ISDN-BRI Trunk Group | ■ Group Type                     | <a href="#">7-198</a> |
|                      | ■ Hop Dgt                        |                       |
|                      | ■ Supplementary Service Protocol |                       |
| ISDN-PRI Trunk Group | ■ Group Type                     | <a href="#">7-219</a> |
|                      | ■ Hop Dgt                        |                       |
|                      | ■ Supplementary Service Protocol |                       |
| Route Pattern        | ■ Hop Lmt                        | <a href="#">8-67</a>  |

- On ISDN trunk group form, set `Group Type` to **isdn**, `Hop Dgt` to **y**, and `Supplementary Service` to **b** for QSIG or **d** for ECMA.
- On Route Pattern form, set `Hop Lmt`.

### QSIG Interactions

#### QSIG Call Forwarding (Diversion) interactions

The interactions that apply to the standard DEFINITY ECS Call Forwarding features also apply to Call Forwarding (Diversion) with QSIG. See [“Call Forwarding” on page 4-224](#) for a description of these interactions. The following are additional interactions.

- Alternate Facilities Restriction Levels
 

The AFRL of the original call is the AFRL used for Call Forwarding with Reroute.
- Authorization Codes
 

Call Forwarding with Reroute is denied to calls that require an Authorization Code.

## 12 Private Networking

### QSIG Transit Counter (ANF-TC)

Page 12-100

- Automatic Alternate Routing and Automatic Route Selection  
Call Forwarding with Reroute uses AAR and ARS to reroute the original call.
- Call Detail Recording  
Call Forwarding with Reroute is denied to calls that require Forced Entry of Account Codes.
- Call Transfer  
When a forwarded call transfers, the forwarding indication displays to the caller until the call is answered. This display includes the trunk group name and word "forward." When the call is answered, the word "forward" is removed and the name and number of the answering party displays.
- Distributed Communications Systems  
Call Forwarding feature transparency does not exist on calls tandemed between a QSIG (Supplementary Service protocol b) network and a traditional DCS network. However, the basic call continues.
- Facility Restriction Levels and Traveling Class Marks  
The FRL (and TCM) of the original call is the FRL used for Call Forwarding with Reroute.
- Forwarding and Coverage  
If a coverage point is a number that routes over an ISDN (Supplementary Service protocol b) trunk, QSIG diversion information is not passed to the coverage switch.
- QSIG Name and Number Identification  
Availability of name and/or number display at the originating and diverted-to users depends upon how QSIG Name and Number Identification has been administered for the switches involved.
- Terminating Call has Coverage Active  
If a call is forwarded off switch, the terminating switch has call coverage activated, and the criteria are met, the call does not route to the forwarding party's coverage path. It routes to the terminating station's coverage path.

### QSIG Call Transfer interactions

- Call Forwarding (Diversion)  
When a call is forwarded and transferred or transferred and forwarded, the forwarding indication displays to the caller until the call is answered. This display includes the trunk group name and word "forward." When the call is answered, the word "forward" is removed and the name and number of the answering party displays.

- Distributed Communications Systems  
The only DCS transparency that exists when a call is transferred in a DCS network and passed over a QSIG administered trunk is calling name.
- QSIG Path Replacement  
ANF-PR is invoked whenever a QSIG transferred call is answered.
- QSIG Name and Number Identification  
Availability of name and/or number display at the connected parties depends upon how QSIG Name and Number Identification has been administered for the switches involved.

### QSIG Name and Number Identification interactions

- Distributed Communications Systems (DCS)  
DEFINITY ECS can display DCS called name/number information or ISDN connected name/number information in a DCS (ISDN) network.  
When an incoming ISDN call is routed back out over a non-ISDN trunk group, DEFINITY ECS can send the name of the non-ISDN trunk group as the connected name if the `Send Non-ISDN Trunk Group Name as Connected Name` is enabled on the Feature-Related System-Parameters form.

### QSIG Path Replacement interactions

- Basic Call Management System  
If the old connection is monitored by a BCMS entity, ANF-PR is blocked due to BCMS measurements.
- Call Detail Recording  
Codes for recording the new connections of ANF-PR calls are code J for incoming trunk calls and code K for outgoing trunk calls. When a path is replaced, you also may receive records for short-duration calls that are not directly linked to the J and K records.
- Call Management System  
If the old connection is monitored by a CMS entity, ANF-PR is blocked due to CMS measurements.
- Call Vectoring
- A transferred call that terminates at a vector and is answered cannot have its path replaced.
- Data-Call Setup  
A data call is denied ANF-PR.

- Data Privacy  
If Data Privacy is active, ANF-PR is denied.
- Data Restriction  
If Data Restriction is active, ANF-PR is denied.
- Malicious Call Trace  
If MCT is active, ANF-PR is denied.
- Recorded Announcement  
A call that is receiving a recorded announcement cannot have its path replaced.
- Trunk Access Code  
The paths of outgoing calls made using a TAC are not replaced.
- Voice Terminals  
Voice terminal displays that show trunk group name should update with new trunk group information after ANF-PR occurs. Calling and connected party displays are not disturbed when ANF-PR takes place if the original display shows the connected party name, number, or both.

### QSIG Transit Counter interactions

- Call Forwarding (Diversion)  
When call forwarding (Diversion) occurs and the ANF-TC feature is enabled, the transit counter is set to zero.
- ISDN Trunk Group Administration  
If all of the conditions are satisfied for both the Tandem Hop Limitation and ANF-TC, ANF-TC takes precedence. In situations where DEFINITY ECS is an Incoming or Outgoing Gateway, either makes use of the hop count/transit count information provided by the other.
- Trunk Access Code  
ANF-TC does not apply to TAC calls.

## Uniform Dial Plan

Uniform Dial Plan (UDP) provides a common 4- or 5-digit dial plan (specified in the Dial Plan Record) that can be shared among a group of switches. Interswitch dialing and intraswitch dialing both require 4- or 5-digit dialing. UDP is used with an electronic tandem network (ETN); main, satellite, and tributary switches; and Distributed Communications Systems (DCS). In addition, UDP can provide uniform 4- or 5-digit dialing between 2 or more private-switching systems without ETN, main, satellite, and tributary switches, or DCS.

### How to administer UDP

#### Required forms

| Form   | Field   | Page  |
|--|---|---|
| Dial Plan Record<br>Second Digit Table         | <ul style="list-style-type: none"> <li>■ Uniform Dial Plan</li> <li>■ UDP Extension Search Order</li> </ul> | <a href="#">5-99</a><br><a href="#">5-264</a> |
| Uniform Dial Plan                              | <ul style="list-style-type: none"> <li>■ All</li> </ul>   | <a href="#">12-121</a>                        |
| AAR and ARS Digit Analysis Table               | <ul style="list-style-type: none"> <li>■ All</li> </ul>   | <a href="#">8-54</a>                          |
| AAR and ARS Digit Conversion Table             | <ul style="list-style-type: none"> <li>■ All</li> </ul>   | <a href="#">8-63</a>                          |
| Node Number Routing                            | <ul style="list-style-type: none"> <li>■ Route Pat</li> </ul>   | <a href="#">12-119</a>                        |
| Extension Number Portability<br>Numbering Plan | <ul style="list-style-type: none"> <li>■ All</li> </ul>   | <a href="#">12-115</a>                        |
| Route Pattern                                  | <ul style="list-style-type: none"> <li>■ All</li> </ul>   | <a href="#">8-67</a>                          |

#### NOTE:

On the Uniform Dialing Plan form, if you change `Ext Code` and `Type` from a 4-digit or 5-digit extension number to **none**, a warning message informs you that all UDP extension codes will be lost. The same warning message displays when you change `Ext Code` and `Type` extension numbers from 4-digits to 5-digits or from 5-digits to 4-digits.

## Detailed description

---

UDP routes calls off the local switch by converting the extension number into a private-network number with 7 digits. This number is formed by prepending a 3-digit code (of the form XXX) to the (last) 4 digits of the extension number. 3 types of conversion are supported: UDPCode, AACode, and ENPCode.

- For UDPCode and AACode, XXX is a 3-digit private-network location code, and the result is analyzed and routed via Automatic Alternate Routing (AAR). UDPCode conversion prohibits digit conversion via AAR; AACode conversion permits it, just as if you dialed the AAR number instead of the extension.
- For ENPCode, XXX is called an Extension Number Portability (ENP) code. It is not used for routing; node-number routing is used instead. The ENP code is chosen based on the first 1 or 2 digits of the dialed string. Because it is not used for routing, the ENPCode can be independent of location.

UDP conversion is specified for individual extensions or groups of extensions sharing the same leading digits, via the UDP form and extension codes. An extension code is the desired leading digits of an extension followed by an "x" (wildcard). For example, "123xx" "12345" is the extension code for all 100 possible extensions beginning with "123" plus two wild cards. "12345" is an extension code specifying one extension.

Each extension code can be assigned to 1 of 6 possible treatments.

- UDPCode — Conversion to AAR with given location code, further conversion suppressed
- AACode — Conversion to AAR with given location code, further conversion allowed
- ENPCode — Conversion to private network number (via ENP form), route to given node number routing
- TempOOS — Temporarily out of service, give reorder
- Local — Local range of extensions
- blank — Similar to local, however, this extension is not chosen when the system is asked to "add a station"

When a user at a switch that is included in a UDP dials an extension, DEFINITY ECS first checks to see if the extension is assigned to a local station on that switch. If so, the call is routed to the station, and UDP is not invoked. If the extension is not found locally, the system checks to see if the extension matches an assigned extension code. If the extension matches an assigned extension code, the system performs the specified conversion into a private network number and routes the call as specified. If more than one extension code matches, the "best" match (most explicit digits) is used. For example, 1234x is chosen over 123xx if 12345 is dialed. However, 123xx is chosen if 12355 is



dialed. If no matching extension code is found, the user receives intercept treatment. Or, if Extended Trunk Access (ETA) is enabled, the call routes via ETA.

### Example of how UDP works

To administer, assign each UDP code:

- To a private network location code (RNX) or node number. (The RNX is equivalent to an office code of a central office in a public network. This RNX determines how a UDP call is routed.)
- Assign each UDP code as either local or remote to the switch.

To understand the function of a UDP, review the following example.

A given station is called using the same 5-digit extension regardless of where in the ETN the call originates. Three switches are included in [Table 12-4](#). Each has been assigned a list of RNX and UDP codes. See [Table 12-4](#) and [Figure 12-6](#).

**Table 12-4. Switch/RMX/UDP Codes**

---

| SWITCH | RNX | UDP CODE |
|--------|-----|----------|
| A      | 224 | 41       |
| C      | 223 | 51       |
| C      | 223 | 52       |
| B      | 222 | 60       |
| B      | 222 | 61       |

---

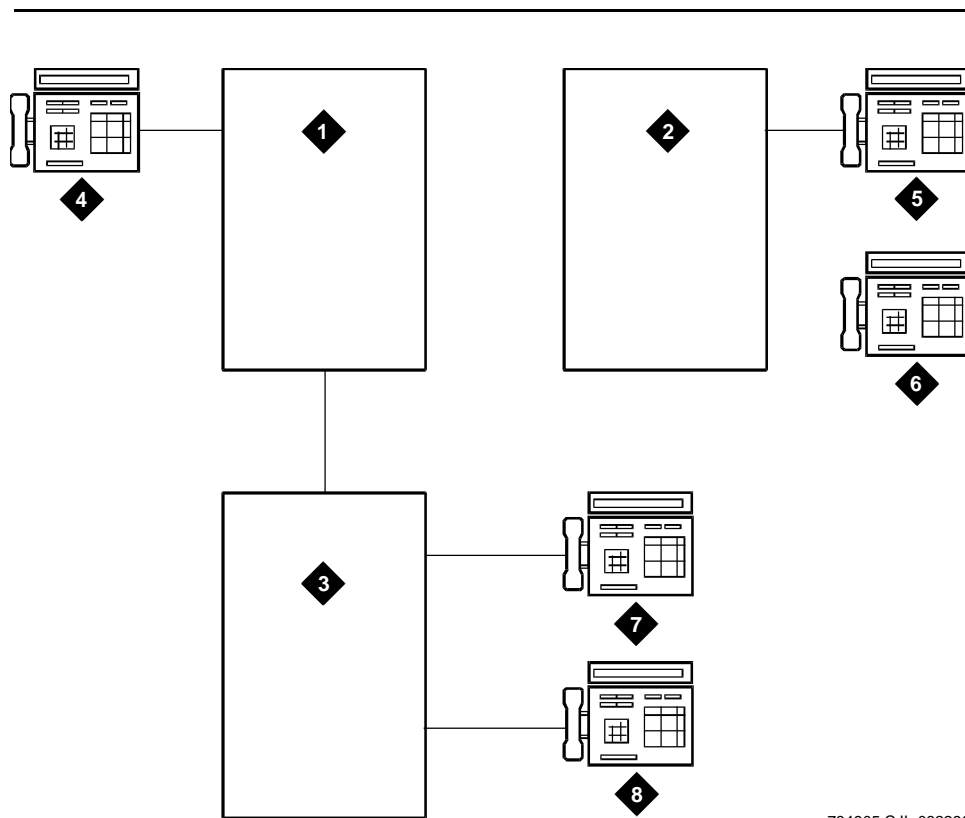

r764905 C.JL 062296

### Figure Notes

- |  |                    |
|--|--------------------|
| 1. Switch A<br>Dial Plan for extensions is 41XXX<br>RNX=224            | 4. Extension 41000 |
| 2. Switch B:<br>Dial Plan for Extensions is 60XXX and 61XXX<br>RNX=222 | 5. Extension 61234 |
| 3. Switch C:<br>Dial Plan for extensions is 51XXX and 52XXX<br>RNX=223 | 6. Extension 60123 |
|  | 7. Extension 51234 |
|  | 8. Extension 5200  |

### Figure 12-6. UDP Example

If a user at extension 41000 wants to call extension 61234, there are two choices:

- Dial 61234
- Dial the AAR access code followed by 222-1234

If 61234 is dialed, the system recognizes 61 as a remote UDP, determines the associated RNX (222), and uses AAR to route the call to 222-1234.

If the AAR access code and 222-1234 are dialed, the system finds the route pattern for RNX 222 and routes the call to the switch associated with that RNX.

Whenever UDP is used to route a call to another switch, the correct digit deletion and insertion must be specified within the route pattern so that the receiving switch gets digits in the format it expects. DEFINITY ECS can be configured in several different ways.

- If AAR is available on the receiving switch, Subnet Trunking can be used to insert the AAR feature access code on the originating switch or digit insertion may be used to insert it on the receiving switch. The receiving switch then uses AAR digit conversion to convert 222 with 7 digits to an extension by deleting 3 digits and inserting a 6.
- If AAR is not available on the receiving switch, Subnet Trunking must be used on the originating switch to delete the 222 and insert the digit 6 at the beginning of the extension number so that the receiving switch can continue to route correctly.

If the user at extension 51234 on Switch C dials extension 61234, the call must first go through Switch A before proceeding to Switch B. When 61234 is dialed, the system recognizes 61 as a UDP code, determines the associated RNX (222), and uses AAR to route the call. The AAR feature access code plus 222-1234 are outpulsed to Switch A. Switch A then recognizes the RNX 222 as a remote switch and routes the call to Switch B and extension 61234. This same type of call routing occurs when an extension at Switch B calls an extension at Switch C.

If extension 61234 on Switch B calls extension 61235, the system recognizes 61 as a local UDP code and routes the call directly to extension 61235.

## Considerations

---

- In North American network environments, extensions beginning with 0 may route to an attendant. You are encouraged to use another number as the leading digit when assigning extensions.
- When you call an extension on another switch, there may be a slight delay before call-progress tones are applied. This delay is due to the trunk signaling necessary to complete the call to the remote switch.
- When you select the option to look at the UDP table first, calls that might otherwise terminate at a local extension route over the network. This is easily reversed. When you remove the extensions from the UDP table, the local extension can be dialed again.

- If AAR is active, FRLs and Traveling Class Marks (TCMs) can be sent along with the private network number. UDPCode and AARCode conversions use the FRL assigned to the caller. ENPNode conversion always raises the FRL to the maximum (7).

If an FRL is insufficient to access the facility, access is denied. There is no prompt for an authorization code even if authorization codes are enabled and administered.

- If AAR is not active, tandem-tie trunks should not be used to transport UDP numbers. The TCM is not recognized at the terminating switch.



**NOTE:**

Never use tandem-tie trunks to transport UDP numbers (the TCM and Hop count will not be recognized as such following the extension received at the receiving switch).

## Interactions

---

- Automatic Alternate Routing

AAR routes UDP calls. (Included with UDP is the required AAR subset.) If AAR is enabled in addition to UDP, then the 7-digit AAR number provides the same routing as UDP.
- Dial Plan
  - All of the extension numbers on a switch are not necessarily part of UDP. Any that do not belong to UDP are handled by a regular, non-UDP Dial Plan associated with the switch.
  - When administering the Dial Plan form and designating a group of extensions as UDP non-local, you can specify whether you want to search for local extensions first or last. This allows flexibility to change extensions from local to non-local and vice-versa.
- DID Trunk Group

DID calls to 5-digit UDP extension numbers require that the DID trunk group insert enough digits to make a 5-digit extension number.
- Distributed Communications System

UDP is required when DCS is provided. The necessary UDP software is provided with the DCS software.
- Extension Number Portability

If an extension code is administered to use ENP node routing, ENP routes the call to the correct switch. If AAR is enabled in addition to UDP, the 7-digit AAR number provides the same routing as UDP (that is, via ENP).

## **Private Networking Forms**

This section describes the following forms related to private networking:

- ATM PNC
- ATM Measurements
- Extended Trunk Access Call Screening Form
- Extension Number Portability Numbering Plan
- Hop Channel Assignments
- Node Number Routing

## .ATM-PNC Form

This form is used to administer the TN2238 circuit pack associated with a port network connectivity (PNC) configuration using an ATM switch. The ATM PNC form is identical for processor port network (PPN) and the expansion port network (EPN).

### Administration Commands

Use the following commands to administer the ATM PNC form.

| Action  | Object  | Qualifier                |
|---------|---------|--------------------------|
| change  | atm pnc | <i>connection-number</i> |
| display | atm pnc | <i>connection-number</i> |
| add     | atm pnc | <i>connection-number</i> |
| remove  | atm pnc | <i>connection-number</i> |
| list    | atm pnc |                          |

#### NOTE:

These commands are available only if the “Asynch. Transfer Mode (ATM) PNC?” field on the Customer Options form is set to “y”.

### Form Description

Page 1 of 1

ATM PNC

Connection Number:

Location:  
 Name:

Address Format:

AFI:  
 E.164:  
 HO-DSP:  
 ESI:  
 SEL:

Screen 12-1. ATM PNC Form — Standard Reliability

Page 1 of 1

ATM PNC

Connection Number:

| A - PNC            | B - PNC            |
|--------------------|--------------------|
| Location:<br>Name: | Location:<br>Name: |
| Address Format:    | Address Format:    |
| AFI:               | AFI:               |
| E.164:             | E.164:             |
| HO-DSP:            | HO-DSP:            |
| ESI:               | ESI:               |
| SEL:               | SEL:               |

### Screen 12-2. ATM PNC Form — Critical Reliability

Make assignments as required for the following fields on the form:

- **Connection Number** — 1–44 entered from the command line. Display only.
- **Location** — Enter cabinet(1–x); carrier(A–E); slot(01–03. Default is blank.
- **Name** — Enter 1–15 alphanumeric characters. Default is blank.
- **Address Format** — Enter **E.164 ATM Private**, **DCC ATM**, or **ICD ATM**. Default is E.164 ATM Private.
- **AFI** — Authority and Format Identifier. Valid values are 39, 45, or 47. Default is 45. Display only.
- **E.164** — Field name may also be DCC or ICD, depending on the value of the Address Format field. Enter 1–15 decimal digits. Default is blank.
- **DCC** — Data Country Code. Enter 1–4 decimal digits. Default is blank.
- **ICD** — International Code Designator. Enter 1–4 decimal digits. Default is blank.
- **HO-DSP** — High-Order Domain-Specific Part. Enter 8 hexadecimal digits if Address Format is **E.164**; otherwise enter 20 hexadecimal digits. Default is blank.
- **ESI** — End System Identifier. Enter 12 hexadecimal digits. Default is blank.
- **SEL** — Selector. Enter 2 hexadecimal digits. Default is blank.

#### NOTE:

For critical reliability, the A-PNC field values cannot be changed; the B-PNC field values can be changed only if A-PNC is active and B-PNC has been busied-out.





## Extended Trunk Access Call Screening Form

---

This form allows a set of digit strings to be identified that should not be routed via ETA. This form can also block the routing of certain FACs or TACs. For example, if the system administrator were to notice a digit string being mistakenly dialed repeatedly that ended up being routed via ETA to a remote PBX only to have the remote PBX return intercept treatment, then that digit string would be a candidate for the entry into the ETA call screening table. Entry into this table would have the effect of return intercept treatment to the caller without first attempting to route the digits to the remote PBX for interpretation via ETA.

### Administration Commands

---

Use the following commands to administer the Extended Trunk Access Call Screening form.

| Action  | Object         | Qualifier |
|---------|----------------|-----------|
| change  | call-screening |           |
| display | call-screening |           |

### Form Instructions

---

Page 1 of 1

ETA CALL SCREENING TABLE

Entry

No. Call Screening Entry

0: \_\_\_\_\_

1: \_\_\_\_\_

2: \_\_\_\_\_

3: \_\_\_\_\_

4: \_\_\_\_\_

5: \_\_\_\_\_

6: \_\_\_\_\_

7: \_\_\_\_\_

8: \_\_\_\_\_

9: \_\_\_\_\_

Screen 12-3. ETA Call Screening Table Form (Page 1 of 1)

12 Private Networking Forms

*Extended Trunk Access Call Screening Form*

Page 12-114

Make assignments as required for the following fields on the form:

- **Call Screening Entry** — Assign those digit strings (up to 10) that should be blocked for this RNX. Each string can have up to 6 digits and/or special or wildcard characters. Valid entries are the digits **0** through **9**, **x**, **X**, **\***, and **#**. The **"#"** character may only be used as the first character.

# Extension Number Portability Numbering Plan Form

## Administration Commands

Use the following commands to administer the ENP Numbering Plan form.

| Action  | Object          | Qualifier <sup>1</sup>  |
|---------|-----------------|-------------------------|
| change  | enp-number-plan |                         |
| display | enp-number-plan | ['print' or 'schedule'] |

1. Brackets [ ] indicate the qualifier is optional. Single quotes ( ' ) indicate the text inside the quote must be entered exactly as shown or an abbreviated form of the word may be entered.

## Form Instructions

Page 1 of 1

EXTENSION NUMBER PORTABILITY  
 NUMBERING PLAN

| ENP<br>Code | ENP<br>Code | ENP<br>Code | ENP<br>Code | ENP<br>Code | ENP<br>Code | ENP<br>Code | ENP<br>Code | ENP<br>Code | ENP<br>Code | ENP<br>Code |
|-------------|-------------|-------------|-------------|-------------|-------------|-------------|-------------|-------------|-------------|-------------|
| 0x: ___     | 1x: ___     | 2x: ___     | 3x: ___     | 4x: ___     | 5x: ___     | 6x: ___     | 7x: ___     | 8x: ___     | 9x: ___     |             |
| 00: ___     | 10: ___     | 20: ___     | 30: ___     | 40: ___     | 50: ___     | 60: ___     | 70: ___     | 80: ___     | 90: ___     |             |
| 01: ___     | 11: ___     | 21: ___     | 31: ___     | 41: ___     | 51: ___     | 61: ___     | 71: ___     | 81: ___     | 91: ___     |             |
| 02: ___     | 12: ___     | 22: ___     | 32: ___     | 42: ___     | 52: ___     | 62: ___     | 72: ___     | 82: ___     | 92: ___     |             |
| 03: ___     | 13: ___     | 23: ___     | 33: ___     | 43: ___     | 53: ___     | 63: ___     | 73: ___     | 83: ___     | 93: ___     |             |
| 04: ___     | 14: ___     | 24: ___     | 34: ___     | 44: ___     | 54: ___     | 64: ___     | 74: ___     | 84: ___     | 94: ___     |             |
| 05: ___     | 15: ___     | 25: ___     | 35: ___     | 45: ___     | 55: ___     | 65: ___     | 75: ___     | 85: ___     | 95: ___     |             |
| 06: ___     | 16: ___     | 26: ___     | 36: ___     | 46: ___     | 56: ___     | 66: ___     | 76: ___     | 86: ___     | 96: ___     |             |
| 07: ___     | 17: ___     | 27: ___     | 37: ___     | 47: ___     | 57: ___     | 67: ___     | 77: ___     | 87: ___     | 97: ___     |             |
| 08: ___     | 18: ___     | 28: ___     | 38: ___     | 48: ___     | 58: ___     | 68: ___     | 78: ___     | 88: ___     | 98: ___     |             |
| 09: ___     | 19: ___     | 29: ___     | 39: ___     | 49: ___     | 59: ___     | 69: ___     | 79: ___     | 89: ___     | 99: ___     |             |

Screen 12-4. Extension Number Portability Numbering Plan Form (Page 1 of 1)

Make assignments as required for the following fields on the form.

- **ENP Code** — Assign a 3-digit code to translate each 4- or 5-digit UDP extension that is node number routed to a 7 digit, AAR-like number used for outpulsing a call within an ENP sub network. This field maps each leading digit of a UDP extension to an ENP Code or blank.

## Hop Channel Assignments Form

This form assigns Hop Channels. The maximum number of connections that may be established between channels on the system's interface links varies depending on System configuration.

### Administration Commands

Use the following commands to administer the Hop Channel Assignment form.

| Action  | Object                  | Qualifier <sup>1</sup>               |
|---------|-------------------------|--------------------------------------|
| change  | communication-interface | hop-channels                         |
| display | communication-interface | hop-channels ['print' or 'schedule'] |

1. Brackets [ ] indicate the qualifier is optional. Single quotes ( ' ' ) indicate the text inside the quote must be entered exactly as shown or an abbreviated form of the word may be entered.

HOP CHANNEL ASSIGNMENT Page 1 of 4

| Link/Channel A | Link/Channel B | Link/Channel A | Link/Channel B |
|----------------|----------------|----------------|----------------|
| 1: — —         | — —            | 17: — —        | — —            |
| 2: — —         | — —            | 18: — —        | — —            |
| 3: — —         | — —            | 19: — —        | — —            |
| 4: — —         | — —            | 20: — —        | — —            |
| 5: — —         | — —            | 21: — —        | — —            |
| 6: — —         | — —            | 22: — —        | — —            |
| 7: — —         | — —            | 23: — —        | — —            |
| 8: — —         | — —            | 24: — —        | — —            |
| 9: — —         | — —            | 25: — —        | — —            |
| 10: — —        | — —            | 26: — —        | — —            |
| 11: — —        | — —            | 27: — —        | — —            |
| 12: — —        | — —            | 28: — —        | — —            |
| 13: — —        | — —            | 29: — —        | — —            |
| 14: — —        | — —            | 30: — —        | — —            |
| 15: — —        | — —            | 31: — —        | — —            |
| 16: — —        | — —            | 32: — —        | — —            |

Screen 12-5. Hop Channel Assignment Form (Page 1 of 4)



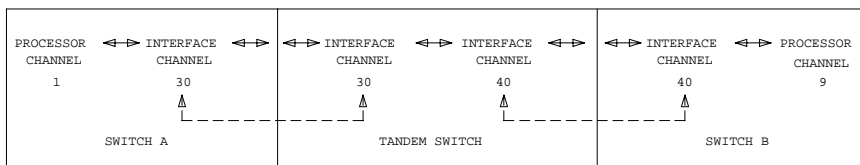

THE INTERFACE CHANNELS ON THE TANDEM SWITCH SHOULD MATCH THE INTERFACE CHANNELS ON SWITCHES A AND B. THE PROCESSOR CHANNELS DO NOT HAVE TO MATCH.

Figure 12-1. Interface Channel Assignments Between Switches

## Node Number Routing Form

---

This form specifies the routing pattern associated with each node in a public or private network. NNR is a required capability for Extension Number Portability (ENP) and is associated with the Uniform Dial Plan (UDP).

### Administration Commands

---

Use the following commands to administer the Node Number Routing form.

| Action  | Object       | Qualifier <sup>1</sup>                       |
|---------|--------------|--|
| change  | node-routing | Enter digits between 1-MAX ['partition' 1-8] |
| display | node-routing | Enter digits between 1-MAX ['partition' 1-8] |
| list    | node-routing | Enter digits between 1-MAX ['partition' 1-8] |

- 
1. Brackets [ ] indicate the qualifier is optional. Single quotes ( ' ' ) indicate the text inside the quote must be entered exactly as shown or an abbreviated form of the word may be entered. MAX is the maximum number available in your system configuration.

**Form Instructions**

```

change node-routing 87 partition 2
                                     Page 1 of 2
                                     NODE NUMBER ROUTING
                                     Partitioned Group Number: 2
Route   Route   Route   Route   Route   Route   Route
Pat     Pat     Pat     Pat     Pat     Pat     Pat
1: _____ 15: _____ 30: _____ 45: _____ 60: _____ 75: _____ 90: _____
2: _____ 16: _____ 31: _____ 46: _____ 61: _____ 76: _____ 91: _____
3: _____ 17: _____ 32: _____ 47: _____ 62: _____ 77: _____ 92: _____
4: _____ 18: _____ 33: _____ 48: _____ 63: _____ 78: _____ 93: _____
5: _____ 19: _____ 34: _____ 49: _____ 64: _____ 79: _____ 94: _____
6: _____ 20: _____ 35: _____ 50: _____ 65: _____ 80: _____ 95: _____
7: _____ 21: _____ 36: _____ 51: _____ 66: _____ 81: _____ 96: _____
8: _____ 22: _____ 37: _____ 52: _____ 67: _____ 82: _____ 97: _____
9: _____ 23: _____ 38: _____ 53: _____ 68: _____ 83: _____ 98: _____
10: _____ 24: _____ 39: _____ 54: _____ 69: _____ 84: _____ 99: _____
11: _____ 25: _____ 40: _____ 55: _____ 70: _____ 85: _____
12: _____ 26: _____ 41: _____ 56: _____ 71: _____ 86: _____
13: _____ 27: _____ 42: _____ 57: _____ 72: _____ 87: _____
14: _____ 28: _____ 43: _____ 58: _____ 73: _____ 88: _____
15: _____ 29: _____ 44: _____ 59: _____ 74: _____ 89: _____
    
```

Screen 12-7. Node Number Routing Form (Page 1 of 2)

Make assignments as required for the following fields on the form.

- **Partitioned Group Number** — This read-only field displays the partitioned group number associated with the node numbers being administered. The partitioned group number is either specified on the command line or defaults to partitioned group number 1.
- **Node Number** — This display-only field lists the node number to be changed.



**NOTE:**

Two pages display simultaneously for a total of 200 nodes (100 per page). For example, entering **change node-routing 87** displays nodes 1 through 199, and entering **change node-routing 151** displays nodes 100 through 299. However, entering **change node-routing 999** displays nodes 900 through 999 on one page.

- **Route Pat** — Enter the routing pattern associated with the corresponding node number. This field repeats the same number of times as there are node numbers on the page; default is blank



## Uniform Dial Plan Form

This form administers the Uniform Dial Plan (UDP).

### Administration Commands

Use the following commands to administer the Uniform Dial Plan form.

| Action  | Object | Qualifier <sup>1</sup>  |
|---------|--------|---|
| change  | udp    | Enter 1-MAX digits between 0-9, 'x' or 'X'  |
| display | udp    | Enter 1-MAX digits between 0-9, 'x' or 'X' ['print' or 'schedule']                        |
| list    | udp    | Enter ['ext' x]['to-ext' x][ 'type' x [[ 'dest' x][to-dest' x]] ] ['print' or 'schedule'] |

1. Brackets [ ] indicate the qualifier is optional. Single quotes ( ' ') indicate the text inside the quote must be entered exactly as shown or an abbreviated form of the word may be entered. MAX is the maximum number available in your system configuration.

### Form Instructions

Page 1 of 2

UNIFORM DIALING PLAN  
 Ext Codes: \_\_\_\_\_  
 Ext Code: \_\_\_\_\_ Type: \_\_\_\_\_

| dd  | Type  | dd  | Type  | dd  | Type  | dd  | Type  | dd  | Type  |
|-----|-------|-----|-------|-----|-------|-----|-------|-----|-------|
| 0x: | _____ | 1x: | _____ | 2x: | _____ | 3x: | _____ | 4x: | _____ |
| 00: | _____ | 10: | _____ | 20: | _____ | 30: | _____ | 40: | _____ |
| 01: | _____ | 11: | _____ | 21: | _____ | 31: | _____ | 41: | _____ |
| 02: | _____ | 12: | _____ | 22: | _____ | 32: | _____ | 42: | _____ |
| 03: | _____ | 13: | _____ | 23: | _____ | 33: | _____ | 43: | _____ |
| 04: | _____ | 14: | _____ | 24: | _____ | 34: | _____ | 44: | _____ |
| 05: | _____ | 15: | _____ | 25: | _____ | 35: | _____ | 45: | _____ |
| 06: | _____ | 16: | _____ | 26: | _____ | 36: | _____ | 46: | _____ |
| 07: | _____ | 17: | _____ | 27: | _____ | 37: | _____ | 47: | _____ |
| 08: | _____ | 18: | _____ | 28: | _____ | 38: | _____ | 48: | _____ |
| 09: | _____ | 19: | _____ | 29: | _____ | 39: | _____ | 49: | _____ |

Page 2 of 2

UNIFORM DIALING PLAN  
 Ext Codes: \_\_\_\_\_  
 Ext Code: \_\_\_\_\_ Type: \_\_\_\_\_

| dd        | Type  | dd        | Type  | dd        | Type  | dd        | Type  | dd        | Type  |
|-----------|-------|-----------|-------|-----------|-------|-----------|-------|-----------|-------|
| 5x: _____ | _____ | 6x: _____ | _____ | 7x: _____ | _____ | 8x: _____ | _____ | 9x: _____ | _____ |
| 50: _____ | _____ | 60: _____ | _____ | 70: _____ | _____ | 80: _____ | _____ | 90: _____ | _____ |
| 51: _____ | _____ | 61: _____ | _____ | 71: _____ | _____ | 81: _____ | _____ | 91: _____ | _____ |
| 52: _____ | _____ | 62: _____ | _____ | 72: _____ | _____ | 82: _____ | _____ | 92: _____ | _____ |
| 53: _____ | _____ | 63: _____ | _____ | 73: _____ | _____ | 83: _____ | _____ | 93: _____ | _____ |
| 54: _____ | _____ | 64: _____ | _____ | 74: _____ | _____ | 84: _____ | _____ | 94: _____ | _____ |
| 55: _____ | _____ | 65: _____ | _____ | 75: _____ | _____ | 85: _____ | _____ | 95: _____ | _____ |
| 56: _____ | _____ | 66: _____ | _____ | 76: _____ | _____ | 86: _____ | _____ | 96: _____ | _____ |
| 57: _____ | _____ | 67: _____ | _____ | 77: _____ | _____ | 87: _____ | _____ | 97: _____ | _____ |
| 58: _____ | _____ | 68: _____ | _____ | 78: _____ | _____ | 88: _____ | _____ | 98: _____ | _____ |
| 59: _____ | _____ | 69: _____ | _____ | 79: _____ | _____ | 89: _____ | _____ | 99: _____ | _____ |

Screen 12-9. Uniform Dial Plan Form (Page 2 of 2)

Make assignments as required for the following fields on each page of the form:

- **Ext Codes** — Displays a string of digits, "x", and "dd." The position of the dd shows which digit positions of the Ext Codes are being administered. For example, **512dd** means that the last two digits of the Ext Codes, for the leading digits 512, are being administered on the form. The string, **5ddxx**, shows that the second and third digits of the Ext Codes, for the leading digit 5, are being administered on the form (these entries would all be wildcard entries).
- **Ext Code, Type** (and associated data) — Displays what rules apply if the entries on the form are not administered. For example, shows a form for Ext Codes starting with 512. If these entries are not administered, the entry for Ext Code 51xxx applies to these entries, and if Ext Code 51xxx is not administered, the entry for Ext Code 5xxxx applies to these entries. In a 5-digit UDP, these read-only fields display only if at least 3 digits are specified in the command-line key, although one set (the set on the left) of these fields would still display if 2 digits are specified in the command-line key. If only 1 digit is specified or if 'x' or 'X' is specified in the command-line key, then neither of these sets of fields display, since there is no Ext Code more general than those listed on the form.
- **dd** — Displays the two digits (or x's) representing the extension or group of extensions to be administered. For this field, "xx:" is repeated on both pages, since it is the default for all other entries on both pages. Changing the type associated with this field on one page changes it on both pages.
- **Type** — Specify the type of treatment for the extension (**AARCode**, **ENPNode**, **Local**, **TempOOS**, **UDPCode**, or blank). That is, specify whether the extension should receive intercept treatment, be converted to AAR, or be converted via ENP. The difference between AAR Location Codes and UDP Location Codes is that 7-digit AAR Numbers created from

AAR Location Codes may be changed during AAR analysis by AAR digit conversion before being routed. Seven-digit AAR Numbers created from UDP Location Codes are not subject to digit conversion before being routed with AAR digit analysis.

When an extension code that is displayed on the UDP form is not administrable because it conflicts with the translations in the first and/or second digit tables, then the type field for that extension code displays "NotInDP."

The entry **TempOOS** indicates an extension is temporarily out-of-service. Calls to these extensions receive reorder.

A blank entry indicates this Ext code is not administered. If no matching code can be found, then the call receives intercept treatment.

- **Location Code** — Specify the 3-digit location code for Ext Codes administered with a type of AARCode or UDPCode. This field displays if AARCode or UDPCode is entered as the type.
- **Node Number** — Specify the node number for Ext Codes administered with a type of ENPNode. This field pops up if ENPNode is entered as the type.



**NOTE:**

This node number must not be the same as the local node number on the dial plan form.



## **Transition Reference**



---

### **DEFINITY ECS R6.1 to R6.3 Transition Reference**

This appendix presents two types of information. First, it lists all DEFINITY ECS Release 6.3 features, and notes which are new or changed for Release 6.3. Second, it provides a brief description of feature changes. See the individual feature descriptions for a detailed explanation of new and changed features.

### **Release 6.3 Features**

[Table A-1](#) lists R6.3 enhancements to existing features.

**Table A-1. Release 5.4 to Release 6.3 Transition Reference**

| <b>Feature Name</b>   | <b>New R6.3 Feature</b> | <b>Changed for R6.3</b> |
|---|-------------------------|-------------------------|
| 6400-Series Voice Terminals   |                         |                         |
| 7505D, 7506D, 7507D, 8503D, 8510T, and 8520T ISDN-BRI Voice Terminals |                         |                         |
| AAR and ARS   |                         | X                       |
| AAR/ARS Overlap Sending   |                         |                         |
| AAR/ARS Partitioning  |                         |                         |
| AAR and ARS Digit Analysis Table                                      |                         | X                       |
| AAR and ARS Digit Conversion Table                                    |                         | X                       |
| Abandoned Call Search   |                         |                         |
| Abbreviated Dialing (Enhanced)  |                         | X                       |
| Access Trunk Group  |                         |                         |
| Add/Remove Skills   |                         |                         |
| Additional External Alarming <sup>1</sup>                             |                         |                         |
| Administrable Language Displays                                       |                         |                         |
| Administrable Logins  |                         |                         |
| Administered Connections  |                         |                         |
| Administration Without Hardware                                       |                         |                         |
| Agent Call Handling   |                         |                         |
| Agent Sizing  |                         |                         |
| Alphanumeric Dialing  |                         |                         |
| Alternate Facility Restriction Levels                                 |                         |                         |
| Answer Detection  |                         |                         |
| Alternate OSSA Number   |                         |                         |
| Attendant Auto-Manual Splitting                                       |                         |                         |
| Attendant Backup Alerting   |                         |                         |
| Attendant Call Waiting  |                         |                         |
| Attendant Control of Trunk Group Access                               |                         |                         |
| Attendant Direct Extension Selection With Busy Lamp Field             |                         |                         |

*Continued on next page*

**Table A-1. Release 5.4 to Release 6.3 Transition Reference — *Continued***

| <b>Feature Name</b>   | <b>New R6.3 Feature</b> | <b>Changed for R6.3</b> |
|---|-------------------------|-------------------------|
| Attendant Direct Trunk Group Selection                                |                         |                         |
| Attendant Display   |                         |                         |
| Attendant Intrusion (Call Offer)                                      |                         |                         |
| Attendant Override of Diversion Features                              |                         |                         |
| Attendant Priority Queue  |                         |                         |
| Attendant Recall  |                         |                         |
| Attendant Release Loop Operation                                      |                         |                         |
| Attendant Room Status   |                         |                         |
| Attendant Serial Calling  |                         |                         |
| Audible Message Waiting   |                         |                         |
| Audio Information Exchange (AUDIX) Interface                          |                         |                         |
| Authorization Codes   |                         |                         |
| Auto-Available Split (AAS)  |                         |                         |
| Automatic Alternate Routing (AAR) and Automatic Route Selection (ARS) |                         |                         |
| Automatic Callback  |                         |                         |
| Automatic Call Distribution (ACD)                                     |                         |                         |
| Automatic Circuit Assurance   |                         |                         |
| Automatic Hold  |                         |                         |
| Automatic Incoming Call Display                                       |                         |                         |
| Automatic Transmission Measurement System                             |                         |                         |
| Automatic Wakeup  |                         |                         |
| Auto-Start/Don't Split  |                         |                         |
| Basic Call Management System (BCMS)                                   |                         |                         |
| Best Service Routing™   | X                       |                         |
| Block Collect Call  |                         |                         |
| Bridged Call Appearance   |                         |                         |
| Busy Verification of Terminals and Trunks                             |                         |                         |

*Continued on next page*

**Table A-1. Release 5.4 to Release 6.3 Transition Reference — Continued**

| <b>Feature Name</b>                           | <b>New R6.3 Feature</b> | <b>Changed for R6.3</b> |
|---|-------------------------|-------------------------|
| Button View                                   |                         | X?                      |
| Call-By-Call Service Selection                |                         |                         |
| Call Charge Information                       |                         |                         |
| Call Coverage                                 |                         |                         |
| Call Detail Recording (CDR)                   |                         |                         |
| Call Forwarding                               |                         |                         |
| Call Forward Busy/Don't Answer                |                         |                         |
| Call Park                                     |                         |                         |
| Call Pickup                                   |                         |                         |
| Call Prompting                                |                         |                         |
| Call Timer                                    | X                       |                         |
| Call Vectoring                                |                         | X?                      |
| Call Waiting Termination                      |                         |                         |
| CAMA Trunk Group                              |                         |                         |
| CAMA Numbering Format form                    |                         |                         |
| Centralized Attendant Service (CAS)           |                         |                         |
| CentreVu® Call Management System <sup>2</sup> |                         | X?                      |
| Class of Restriction (COR)                    |                         | X                       |
| Class of Service (COS)                        |                         |                         |
| Clear Message Waiting Indicators              |                         |                         |
| Code Calling Access                           |                         |                         |
| Conference — Attendant                        |                         |                         |
| Conference — Terminal                         |                         |                         |
| Constellation Voice/Data Terminal Support     |                         |                         |
| Consult                                       |                         |                         |
| CO Trunk Group                                |                         | X                       |
| Coverage Callback                             |                         |                         |
| Coverage Incoming Call Identification (ICI)   |                         |                         |

*Continued on next page*



**Table A-1. Release 5.4 to Release 6.3 Transition Reference — *Continued***

| <b>Feature Name</b>                                      | <b>New R6.3 Feature</b> | <b>Changed for R6.3</b> |
|--|-------------------------|-------------------------|
| CPN Restriction  |                         |                         |
| Customer-Provided Equipment (CPE) Alarm                  |                         |                         |
| Data Call Setup  |                         |                         |
| Data Hot Line  |                         |                         |
| Data-Only Off-Premises Extensions                        |                         |                         |
| Data Privacy   |                         |                         |
| Data Restriction   |                         |                         |
| DCS with Rerouting                                       |                         |                         |
| Distributed Communication System (DCS)                   |                         | X                       |
| Default Dialing  |                         |                         |
| DEFINITY LAN Gateway                                     |                         |                         |
| Dial Access to Attendant                                 |                         |                         |
| Dial Plan  |                         |                         |
| Digital Multiplexed Interface                            |                         |                         |
| Direct Inward Dialing (DID) Trunk Group                  |                         | X                       |
| Direct Inward and Outward Dialing (DIOD) — International |                         |                         |
| Direct Inward and Outward Dialing (DIOD) Trunk Group     |                         | X                       |
| Distinctive Ringing                                      |                         |                         |
| DMI-BOS Trunk Group                                      |                         |                         |
| Do Not Disturb   |                         |                         |
| DS1 Circuit Pack Form                                    |                         |                         |
| DS1 Trunk Service (T1 and E1)                            |                         |                         |
| EIA Interface  |                         |                         |
| Emergency Access to the Attendant                        |                         |                         |
| Enhanced Voice Terminal Display                          |                         |                         |
| Expert Agent Selection                                   |                         |                         |
| Extended User Administration of Redirected Calls         |                         |                         |

*Continued on next page*

**Table A-1. Release 5.4 to Release 6.3 Transition Reference — *Continued***

| <b>Feature Name</b>   | <b>New R6.3 Feature</b> | <b>Changed for R6.3</b> |
|---|-------------------------|-------------------------|
| Facility and Non-Facility Associated Signaling                    |                         |                         |
| Facility Busy Indication  |                         |                         |
| Facility Restriction Levels (FRL) and Traveling Class Marks (TCM) |                         |                         |
| Facility Test Calls   |                         |                         |
| Feature Access Code   |                         | X?                      |
| Feature-Related System Parameters                                 |                         | X                       |
| Fiber Link Administration   |                         | X                       |
| Flexible Billing  |                         |                         |
| Forced Password Aging   |                         |                         |
| Generalized Route Selection (GRS)                                 |                         |                         |
| Go to Cover   |                         |                         |
| Group Listen  |                         |                         |
| Group Paging  |                         |                         |
| Hold  |                         |                         |
| Hold—Automatic  |                         |                         |
| Hospitality   |                         |                         |
| Hot Line Service  |                         |                         |
| Hunting   |                         |                         |
| Inbound Call Management   |                         |                         |
| Incoming Call Line Identification on Analog Trunk                 | X                       |                         |
| Individual Attendant Access                                       |                         |                         |
| Information Forwarding  | X                       |                         |
| Integrated Directory  |                         |                         |
| Intercept Treatment   |                         |                         |
| Intercom — Automatic  |                         |                         |
| Intercom — Dial   |                         |                         |
| Internal Automatic Answer   |                         |                         |

*Continued on next page*

**Table A-1. Release 5.4 to Release 6.3 Transition Reference — Continued**

| <b>Feature Name</b>                                       | <b>New R6.3 Feature</b> | <b>Changed for R6.3</b> |
|---|-------------------------|-------------------------|
| Inter-PBX Attendant Calls                                 |                         |                         |
| Intraflow and Interflow                                   |                         |                         |
| ISDN-BRI Circuit Pack form                                |                         | X                       |
| ISDN-BRI Trunk Circuit Pack                               |                         | X                       |
| ISDN-BRI Trunk Group                                      |                         | X                       |
| ISDN-BRI (S/T)  |                         |                         |
| ISDN BRI (U-Zwire)  |                         |                         |
| ISDN - General  |                         | X                       |
| ISDN Numbering - Private                                  |                         |                         |
| ISDN-PRI Trunk Group                                      |                         | X                       |
| International Operator Access                             |                         |                         |
| Language Translations                                     |                         | X?                      |
| Last Number Dialed  |                         |                         |
| Leave Word Calling  |                         |                         |
| Line Lockout  |                         |                         |
| Look Ahead Interflow                                      |                         | X                       |
| Look Ahead Routing  |                         |                         |
| Loudspeaker Paging Access                                 |                         |                         |
| Malicious Call Trace                                      |                         |                         |
| Manual Message Waiting                                    |                         |                         |
| Manual Originating Line Service                           |                         |                         |
| Manual Signaling  |                         |                         |
| MERLIN®/System 25 — Voice Terminal Support (731xH Series) |                         |                         |
| Misoperations Handling (modified)                         |                         |                         |
| Modem Pooling   |                         |                         |
| Multi-Appearance Preselection and Preference              |                         |                         |
| Multifrequency Signaling                                  |                         | X                       |

*Continued on next page*

**Table A-1. Release 5.4 to Release 6.3 Transition Reference — *Continued***

| <b>Feature Name</b>                                | <b>New R6.3 Feature</b> | <b>Changed for R6.3</b> |
|--|-------------------------|-------------------------|
| Multifrequency-Signaling-Related System Parameters |                         | X                       |
| Multimedia Applications Server Interface           |                         |                         |
| Multimedia Call Handling                           |                         | X                       |
| Multiple Call Handling                             |                         |                         |
| Music-on-Hold Access                               |                         |                         |
| Names Registration                                 |                         |                         |
| Network Access — Private                           |                         |                         |
| Night Service                                      |                         | X                       |
| On-Hook Dialing                                    | X                       |                         |
| PC Interface                                       |                         |                         |
| Personal Central Office Line (PCOL)                |                         |                         |
| Personal Station Access                            |                         |                         |
| Personalized Ringing                               |                         |                         |
| Power Failure Transfer                             |                         |                         |
| PRI Endpoint                                       |                         |                         |
| Priority Calling                                   |                         |                         |
| Privacy — Attendant Lockout                        |                         |                         |
| Privacy — Manual Exclusion                         |                         |                         |
| Property Management System Interface               |                         | X                       |
| Public Network Call Priority                       |                         |                         |
| Pull Transfer                                      |                         |                         |
| QSIG   |                         | X                       |
| QSIG Supplementary Service - Call Completion       | X                       |                         |
| Queue Status Indications                           |                         |                         |
| Reason Codes                                       |                         |                         |
| Recall Signaling                                   |                         |                         |
| Recent Change History                              |                         |                         |

*Continued on next page*

**Table A-1. Release 5.4 to Release 6.3 Transition Reference — *Continued***

| <b>Feature Name</b>                   | <b>New R6.3 Feature</b> | <b>Changed for R6.3</b> |
|---------------------------------------|-------------------------|-------------------------|
| Recorded Announcement                 |                         |                         |
| Recorded Telephone Dictation Access   |                         |                         |
| Redirection On No Answer (RONA)       |                         |                         |
| Remote Access                         |                         |                         |
| Report Scheduler and System Printer   |                         |                         |
| Restriction — Controlled              |                         |                         |
| RHNPA Table                           |                         |                         |
| Ringback Queuing                      |                         |                         |
| Ringer Cutoff                         |                         |                         |
| Ringling — Abbreviated and Delayed    |                         |                         |
| Rotary Dialing                        |                         |                         |
| Route Pattern Form                    |                         |                         |
| Security Violation Notification (SVN) |                         |                         |
| Send All Calls                        |                         |                         |
| Service Observing                     |                         |                         |
| Signaling Group                       |                         | X                       |
| Station Form Field Descriptions       |                         | X                       |
| Station Hunting                       |                         |                         |
| Station Security Code                 |                         |                         |
| Subnet Trunking                       |                         |                         |
| Switch Based Bulletin Board           |                         |                         |
| Synchronization Plan                  |                         | X                       |
| System-Parameters Customer-Options    |                         | X                       |
| Tandem Trunk Group                    |                         |                         |
| Temporary Bridged Appearance          |                         |                         |
| Tenant Partitioning                   |                         |                         |
| Terminal Self Administration          |                         |                         |
| Terminal Translation Initiation       |                         |                         |

*Continued on next page*

**Table A-1. Release 5.4 to Release 6.3 Transition Reference — *Continued***

| <b>Feature Name</b>                              | <b>New R6.3 Feature</b> | <b>Changed for R6.3</b> |
|--|-------------------------|-------------------------|
| Terminating Extension Group                      |                         |                         |
| Through Dialing                                  |                         |                         |
| Tie Trunk Group                                  |                         |                         |
| Time of Day Routing                              |                         |                         |
| Time of Day Routing Plan                         |                         |                         |
| Timed Reminder and Attendant Timers              |                         |                         |
| Transfer   |                         |                         |
| Transfer Outgoing Trunk to Outgoing Trunk        |                         |                         |
| Trunk Flash                                      |                         |                         |
| Trunk Group Busy/Warning Indicators to Attendant |                         |                         |
| Trunk Groups - General                           |                         | X                       |
| Trunk Identification By Attendant                |                         |                         |
| Trunk-to-Trunk Transfer                          |                         |                         |
| Uniform Dial Plan (UDP)                          |                         |                         |
| Universal Call ID (UCID)                         | X                       |                         |
| Unrestricted Uniform Dial Plan)                  |                         |                         |
| VDN of Origin Announcements                      |                         |                         |
| Visually Impaired Attendant Services (VIAS)      |                         |                         |
| Voice Message Retrieval                          |                         |                         |
| Voice Messaging Systems                          |                         |                         |
| Voice Response Integration                       |                         |                         |
| Voice Terminal Alerting Options                  |                         |                         |
| Voice Terminal Display                           |                         |                         |
| Voice Terminal Feature Button Descriptions       |                         | X                       |
| Voice Terminal, PC Interface, and Data Module    |                         |                         |
| VuStats  |                         |                         |
| Whisper Page                                     |                         | X                       |
| Wideband Switching                               |                         |                         |

*Continued on next page*

**Table A-1. Release 5.4 to Release 6.3 Transition Reference — Continued**

| <b>Feature Name</b>         | <b>New R6.3 Feature</b> | <b>Changed for R6.3</b> |
|-----------------------------|-------------------------|-------------------------|
| World Class BRI             |                         |                         |
| World Class Tone Detection  |                         |                         |
| World Class Tone Generation |                         |                         |

- 
1. For information about this feature see *DEFINITY Enterprise Communications Server Release 6 — Maintenance and Test for R6r* or *DEFINITY Enterprise Communications Server Release 6 — Maintenance and Test for R6vs/si*.
  2. For information about this feature, see *DEFINITY Enterprise Communications Server Release 5 — Basic Call Management System (BCMS) Operations*.
-

## Release 6.3 Enhancements

---

### Abbreviated Dialing, Enhanced

- Users of 8400 and 6400 display phones can create menu-display labels for AD and other buttons. Abbreviated dialing and display messages can be programmed on these phones with the handset in place.

### 6402D Voice Terminal

- This is a 2-line display terminal that supports 1-way speakerphone.

### Best Service Routing™ (BSR)

- This feature automatically compares splits or skills in ACD environments to find the one that can provide the best service to each caller. BSR can operate at a single site, or it can be used with Look-Ahead Interflow to integrate a network of geographically distributed locations into a virtual call center.

### DIOD Data on Digital Trunk

- Direct Inward and Outward Dialing (DIOD) trunk groups now support both voice and data transmissions.

### Incoming Call Line Identification on Analog Trunks

- ICLID provides the calling party name and number received from the central office (CO) over the TN429D DIOD Trunk circuit pack.

### Information Forwarding

- Whenever DEFINITY ECS interflows a call over ISDN trunk facilities (for example, PRI or BRI) by means of a *route-to* (with Look-Ahead Interflow active), *queue-to best*, or *check best* command, user data is sent with the call via user-to-user information transport (via UUI IE or QSIG MSI) and can be used by adjuncts or displayed at the receiving switch.

### ISDN-BRI Trunk Group

- Now supports DCS over BRI trunks using BX.25 and TCP/IP links, and BRI trunks over the two-wire U interface using the TN2198 circuit pack. Country Protocol 1 (Bellcore National ISDN) was added including support of Service Profile Identifiers (SPIDs) and Endpoint Identifiers, and QSIG features developed for ISDN-PRI in R6.2 and R6.3 (Call Offer, Call Completion, and Message Waiting) are supported on BRI trunks.

### Look-Ahead Interflow

- Balances the load of ACD calls across multiple locations. Enhanced Look-Ahead Interflow (with DEFINITY R6.3) results in First in First Out (FIFO) or near FIFO call routing via a new conditional and uses less computer processing resources.



#### Mode Code Related System Parameters Form

- Three new fields are added to this form: System In Day Service, System In Night Service, and VMS Hunt Group Extension.

#### Multimedia Call Handling

- The new Enhanced mode of operation allows a multifunction user to control a multimedia call like a standard voice call.

#### Multimedia Call Handling — Enhanced Mode

- The Enhanced mode of operation allows a multifunction voice terminal to control a multimedia call like a standard voice call.

#### QSIG Call Independent Signaling Connections

- CISCs are functionally equivalent to the Temporary Signaling Connection supported on DEFINITY ECS. These are used to pass QSIG Supplementary Service information that is independent of an active call between two QSIG compliant nodes.

#### QSIG Supplementary Service - Call Completion

- Completion of Calls to Busy Subscribers and Completion of Calls on No Reply are the equivalent QSIG features of Automatic Callback on Busy and Automatic Callback on No Answer, respectively. Both allow any QSIG network voice user who placed a call to a busy or unanswered voice terminal over the QSIG network to be called back automatically when the called voice terminal becomes available.

#### Russian Incoming ANI

- Provides the switch with the capability to receive the calling party's number from incoming Russian trunks.

#### Russian Multiple ANI

- Allows MF ANI (calling party number, signaled via multifrequency signaling) prefix digits to be defined on a class of restriction basis. This allows a PBX servicing multiple COs to provide different ANIs to each.

#### Universal Call ID

- Tags a call with a unique identifier. In simple call scenarios, the tag stays with that call within a DEFINITY-based network connected by ISDN lines. In complex call scenarios, the tag often merges with other tags.



## Administration Commands

# B

---

### Commands

---

The following pages provide a summary of the available commands and their associated objects.

You can display a list of the available actions, objects and qualifiers at any time by pressing the Help key. The list that appears contains only those words that are appropriate, based on your login permissions and the words already entered on the command line.

### Restrictions

---

You will not be able to execute a command if:

- You do not have permission to execute the command
- The system configuration does not require a command
- The command is a member of a set of commands that is being used by another user.

## Add

---

The add command allows you to add objects to the system. The object you add must not already exist in the system. For example, if you enter the command, **add attendant 3**, there must not already be an "attendant 3." If the name you selected already exists, an error message appears and you will need to rename the attendant or other object.

The following objects are available for use with the *add* command. You can display this list by pressing the Help key after entering the action word "add."

- |                           |                             |                   |
|---------------------------|-----------------------------|-------------------|
| ■ abbreviated-dialing     | ■ eda-external-device-alarm | ■ pgate           |
| ■ access-endpoint         | ■ fiber-link                | ■ pickup-group    |
| ■ administered-connection | ■ hunt-group                | ■ second-digit    |
| ■ agent-loginID           | ■ intercom-group            | ■ signaling-group |
| ■ attendant               | ■ intra-switch-cdr          | ■ station         |
| ■ best-service-routing    | ■ login-ID                  | ■ term-ext-group  |
| ■ cabinet                 | ■ modem-pool                | ■ test-schedule   |
| ■ coverage                | ■ personal-CO-line          | ■ trunk-group     |
| ■ data-module             | ■ pri-endpoint              | ■ vdn             |
| ■ ds1                     | ■ prec                      | ■ vrt             |

## Change

---

The object you want to change must be currently administered in the system. In addition to the objects listed below, you can change adjunct information by entering the command **change adjunct-name**, where adjunct-name is the name of the administered adjunct.

- |                            |                             |                          |
|----------------------------|-----------------------------|--------------------------|
| ■ aar                      | ■ digit-absorption          | ■ remote access          |
| ■ abbreviated-dialing      | ■ display-messages          | ■ report-scheduler       |
| ■ access-endpoint          | ■ ds1                       | ■ rhnpa                  |
| ■ adjunct-controlled-agent | ■ enp-number-plan           | ■ route-pattern          |
| ■ administered-connection  | ■ eda-external-device-alarm | ■ second-digit           |
| ■ agent-loginID            | ■ feature-access-code       | ■ signaling-group        |
| ■ alias                    | ■ fiber-link                | ■ sit-treatment          |
| ■ alphanumeric-dial-table  | ■ hunt-group                | ■ site-data              |
| ■ alternate-frl            | ■ intercom-group            | ■ station                |
| ■ announcements            | ■ integ-annc-brd-loc        | ■ synchronization        |
| ■ ars                      | ■ intra-switch-cdr          | ■ system-parameters      |
| ■ best-service-routing     | ■ isdn                      | ■ telecommuting-access   |
| ■ bulletin-board           | ■ ixc-codes                 | ■ tenant                 |
| ■ attendant                | ■ listed-directory-numbers  | ■ term-ext-group         |
| ■ authorization-code       | ■ login                     | ■ terminal-parameters    |
| ■ cabinet                  | ■ mct-group-extensions      | ■ test-schedule          |
| ■ call-screening           | ■ meas-selection            | ■ time-of-day            |
| ■ circuit-packs            | ■ modem-pool                | ■ toll                   |
| ■ communication-interface  | ■ mst                       | ■ trunk-group            |
| ■ console-parameters       | ■ music-source              | ■ udp                    |
| ■ cor                      | ■ node-routing              | ■ vdn                    |
| ■ cos                      | ■ paging password           | ■ vector                 |
| ■ coverage                 | ■ permissions               | ■ vrt                    |
| ■ data-module              | ■ personal-CO-line          | ■ vustats-display-format |
| ■ dialplan                 | ■ pickup-group              |                          |
|                            | ■ pri-endpoint              |                          |

## Clear

---

The clear command allows you to clear measurements for security violations and to clear (turn off) message waiting lamps.

- amw
- measurements

## Display

---

Allows viewing of parameters associated with a specific object/qualifier. If the command *display station 4444* is entered, for example, the voice terminal screen form currently administered for extension 4444 is displayed. If you use the "print" qualifier, for example, *display station 4444 print*, the form is printed on the printer associated with the administration terminal.

The following object words are available for use with the *display* command. In addition to the words listed below, you can display adjunct information by entering the command **display adjunct-name**, where adjunct-name is the name of the administered adjunct.

- |                           |                                 |                            |
|---------------------------|---------------------------------|----------------------------|
| ■ aar                     | ■ coverage                      | ■ listed-directory-numbers |
| ■ abbreviated-dialing     | ■ data-module                   | ■ login                    |
| ■ access-endpoint         | ■ dialplan                      | ■ mct-group-extensions     |
| ■ administered-connection | ■ digit-absorption              | ■ meas-selection           |
| ■ agent-loginID           | ■ disabled-tests                | ■ memory-configuration     |
| ■ alias                   | ■ display-messages              | ■ modem-pool               |
| ■ alphanumeric-dial-table | ■ ds1                           | ■ mst                      |
| ■ alternate-frl           | ■ enp-number-plan               | ■ node-routing             |
| ■ announcements           | ■ errors                        | ■ paging                   |
| ■ ars                     | ■ events                        | ■ permissions              |
| ■ attendant               | ■ eda-external-device-<br>alarm | ■ personal-CO-line         |
| ■ authorization-code      | ■ feature-access-codes          | ■ pgate                    |
| ■ best-service-routing    | ■ fiber-link                    | ■ pickup-group             |
| ■ bulletin-board          | ■ hunt-group                    | ■ port                     |
| ■ buttons-location-aca    | ■ initcauses                    | ■ pri-endpoint             |
| ■ cabinet                 | ■ integrated-annc-boards        | ■ reason-code-names        |
| ■ call-screening          | ■ intercom-group                | ■ remote-access            |
| ■ capacity                | ■ internal-data                 | ■ rhnpa                    |
| ■ circuit-packs           | ■ intra-switch-cdr              | ■ route-pattern            |
| ■ communication-interface | ■ isdn                          | ■ second-digit             |
| ■ console-parameters      | ■ ixc-codes                     | ■ signaling-group          |
| ■ cor                     |                                 | ■ sit-treatment            |
| ■ cos                     |                                 |                            |

- |                       |                        |                          |
|-----------------------|------------------------|--------------------------|
| ■ site-data           | ■ telecommuting-access | ■ toll                   |
| ■ software            | ■ term-ext-group       | ■ trunk-group            |
| ■ station             | ■ terminal-parameters  | ■ udp                    |
| ■ svn-button-location | ■ tenant               | ■ vdn                    |
| ■ synchronization     | ■ test-schedule        | ■ vector                 |
| ■ system-parameters   | ■ time                 | ■ vrt                    |
|                       | ■ time-of-day          | ■ vustats-display-format |

## Duplicate

---

Allows duplication of existing objects and must be used with a qualifying extension to automatically establish service for multiple voice terminals and data modules. Only one data module can be duplicated at a time. Up to 16 stations can be duplicated at one time. The objects that can be duplicated are:

- access-endpoint
- administered-connection
- data-modules
- station



## List

---

Displays parameters associated with groups of objects. Use this command to obtain a list of all, or a range of, voice terminals, trunks, and other features that have been administered. The list command and its associated qualifiers can be used to retrieve data for all the ports in the system, or for a specified subset of ports. The following objects are available for use with the *list* command.

- |                             |                         |                          |
|-----------------------------|-------------------------|--------------------------|
| ■ aar                       | ■ integrated-ann-boards | ■ set-data               |
| ■ abbreviated-dialing       | ■ intercom-group        | ■ signaling-group        |
| ■ aca-parameters            | ■ intra-switch-cdr      | ■ sys-link               |
| ■ access-endpoint           | ■ isdn-testcall         | ■ station                |
| ■ administered-connection   | ■ logins                | ■ tenant                 |
| ■ agent-loginID             | ■ marked-ports          | ■ term-ext-group         |
| ■ ars                       | ■ mct-history           | ■ test-schedule          |
| ■ authorization-code        | ■ measurements          | ■ testcalls              |
| ■ bcms                      | ■ members               | ■ toll                   |
| ■ best-service-routing      | ■ modem-pool            | ■ trunk-group            |
| ■ bridged-extensions        | ■ monitored-station     | ■ udp                    |
| ■ cabinet                   | ■ mmi                   | ■ usage                  |
| ■ call-forwarding           | ■ mst                   | ■ vdn                    |
| ■ configuration             | ■ music-source          | ■ vector                 |
| ■ cor                       | ■ multimedia            | ■ vrt                    |
| ■ coverage                  | ■ node-routing          | ■ vustats-display-format |
| ■ data-module               | ■ partitioned-group     | ■ wakeup                 |
| ■ disabled-MOs              | ■ performance           |                          |
| ■ do-not-disturb            | ■ personal-CO-line      |                          |
| ■ emergency                 | ■ pgate                 |                          |
| ■ eda-external-device-alarm | ■ pickup-group          |                          |
| ■ extension-type            | ■ pri-endpoint          |                          |
| ■ fiber-link                | ■ pms-down              |                          |
| ■ groups-of-extension       | ■ report scheduler      |                          |
| ■ historyhunt-group         | ■ route-pattern         |                          |

## Remove

---

Displays the form for the associated object. For example, if you type the command *remove station 8000*, the form for station 8000 appears. If you want to remove this station, press ENTER to delete it from the system. Press CANCEL to leave the station as it is. The following objects are available for use with the *remove* command.

- |                             |                    |                    |
|-----------------------------|--------------------|--------------------|
| ■ abbreviated-dialing       | ■ fiber-link       | ■ report scheduler |
| ■ access-endpoint           | ■ hunt-group       | ■ second-digit     |
| ■ administered-connection   | ■ intercom-group   | ■ signaling-group  |
| ■ agent-loginID             | ■ login            | ■ station          |
| ■ attendant                 | ■ modem-pool       | ■ term-ext-group   |
| ■ best-service-routing      | ■ personal-CO-line | ■ test-schedule    |
| ■ cabinet                   | ■ pgate            | ■ trunk-group      |
| ■ coverage                  | ■ pickup-group     | ■ vdn              |
| ■ data-module               | ■ prec             | ■ vrt              |
| ■ ds1                       | ■ pri-endpoint     |                    |
| ■ eda-external-device-alarm |                    |                    |

## Status

---

Displays the operational status of the facility indicated by the object word. A complete description of all status commands is provided in *DEFINITY Enterprise Communications Server Maintenance*. The following object words are available for use with the *status* command. You can display this list by pressing the Help key after entering the action word "status."

- |                           |                      |                    |
|---------------------------|----------------------|--------------------|
| ■ access-endpoint         | ■ isdn-testcall      | ■ signaling-group  |
| ■ administered-connection | ■ journal-link       | ■ spe              |
| ■ attendant               | ■ link               | ■ sp-link          |
| ■ audits                  | ■ logins             | ■ station          |
| ■ bri-port                | ■ mst                | ■ switch-node      |
| ■ cabinet                 | ■ packet-control     | ■ synchronization  |
| ■ card-mem                | ■ packet-interface   | ■ sys-link         |
| ■ cdr-link                | ■ periodic-scheduled | ■ system           |
| ■ conference              | ■ pgate-port         | ■ trunk            |
| ■ data-module             | ■ pms-link           | ■ tsc-administered |
| ■ hardware-group          | ■ pnc                | ■ tti              |
| ■ health                  | ■ pri-endpoint       | ■ radio-controller |
| ■ interface               | ■ processor-channels | ■ remote-access    |



## References

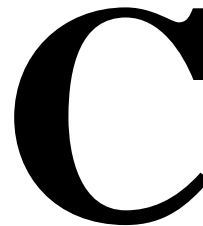

---

This section contains a list of user documents for the DEFINITY Enterprise Communications Server (ECS) Release 6. (Most of these documents are backward compatible with, and can be used with, the DEFINITY ECS Release 5 systems.)

To order these or other DEFINITY documents, contact the Lucent Technologies Publications Center at the address and phone number on the back of the title page of this document. A complete catalog of Business Communications Systems (BCS) documents, including previous issues of the documents listed here, is available on the World Wide Web. Ask your account team for the web address.

### **Basic DEFINITY ECS Documents**

---

These documents are issued for all new and upgrade DEFINITY ECS Release 6 systems.

#### **Administration**

##### ***DEFINITY ECS Release 6 — Overview, Issue 5, 555-230-024***

Provides a detailed overview of the ECS including descriptions of many of the major features, applications, hardware, system capabilities, and the support provided with the system. This document is available in the following languages: English, German (DE), Dutch (NL), Brazilian Portuguese (PTB), European French (FR), Latin Spanish (SPL), Italian (IT), Russian (RU), and Japanese (JA). To order, append the language suffix to the document number; for example, 555-230-894DE for German. No suffix is needed for the English version.

***DEFINITY ECS Release 6.2 — Change Description, Issue 1, 555-230-476***

Gives a high-level overview of what is new in DEFINITY ECS Release 6. Describes the hardware and software enhancements and lists the problem corrections for this release.

***DEFINITY ECS Release 6 — System Description Pocket Reference, Issue 2, 555-230-211***

Provides hardware descriptions, system parameters, listing of hardware required to use features, system configurations, and environmental requirements. This compact reference combines and replaces Release 6 *System Description and Specifications* and Release 6 *Pocket Reference*.

***DEFINITY ECS Release 6 — Administration and Feature Description, Issue 3, 555-230-522***

Provides descriptions of system features. Also provides step-by-step procedures for preparing the screens that are required to implement the features, functions, and services of the system. Includes the applications and benefits, feature interactions, administration requirements, hardware requirements, and procedures for voice terminal, data module, and trunk group administration.

***DEFINITY System's Little Instruction Book, Issue 3, 555-230-727***

Provides step-by-step procedures for performing basic switch administration tasks. Includes managing phones, managing features, generating reports, enhancing system security, and troubleshooting.

***DEFINITY ECS Release 5 — System Monitoring and Reporting, Issue 4, 555-230-511***

Provides detailed descriptions of the measurement, status, security, and recent change history reports available in the system and is intended for administrators who validate traffic reports and evaluate system performance. Includes corrective actions for potential problems. Issue 2 of this document was titled *Traffic Reports*. The Release 5 version of this document applies to Release 6 as well.

***DEFINITY ECS Release 6 — Implementation Blank Forms, Issue 3, 555-230-303***

Provides blank paper forms corresponding to the screens that are required to implement the features, functions, and services of the system. The Release 5 forms apply to Release 6 as well.

***BCS Products Security Handbook, Issue 6, 555-025-600***

Provides information about the risks of telecommunications fraud and measures for addressing those risks and preventing unauthorized use of BCS products. This document is intended for telecommunications managers, console operators, and security organizations within companies.

***DEFINITY ECS Release 6— Terminals and Adjuncts Reference, Issue 9, 555-015-201***

Provides descriptions of the peripheral equipment that can be used with System 75, System 85, DEFINITY Communications System, and DEFINITY ECS. This document is intended for customers and Lucent Technologies account teams for selecting the correct peripherals to accompany an ECS. The Release 5 version of this document applies to Release 6 as well.

***DEFINITY ECS — Telephone Guide Builder, Issue 4, 555-230-755***

Provides capability to produce laser-printed documentation for specific telephones. The software is supported by a comprehensive user's guide and on-line help. This product requires a 386 PC, minimum of 6MB disk space, minimum of 4MB RAM, a printer supported by Microsoft GDI printer drive, and Microsoft Windows 3.1 or higher. A mouse is recommended. This document applies to Release 6 as well as earlier DEFINITY systems.

***DEFINITY ECS — International Telephone Guide Builder, Issue 1, 555-230-742***

Same as 555-230-755 but customized for international locations.

***Guide Builder Software for DEFINITY ECS Telephones, Issue 1, 555-230-755***

Guide Builder is software used to produce laser-printed documentation for specific voice terminals. It is supported by a quick reference guide and online help.

## Installation and Maintenance

***DEFINITY ECS Release 6 — Installation and Test for Single-Carrier Cabinets, Issue 3, 555-230-894***

Provides procedures and information for hardware installation and initial testing of single-carrier cabinets. The Release 5 version of this document applies to Release 6 as well.

This document is available in the following languages: English, German (DE), Dutch (NL), Brazilian Portuguese (PTB), European French (FR), Castillian Spanish (SP), Italian (IT), Russian (RU), and Japanese (JA). To order, append the language suffix to the document number; for example, 555-230-894DE for German. No suffix is needed for the English version.

***DEFINITY ECS Release 6 — Installation and Upgrades for CSCC, Issue 1, 555-230-124***

Provides procedures and information for hardware installation, upgrades, and initial testing of compact single-carrier cabinets. The Release 5 version of this document applies to Release 6 as well.

***DEFINITY ECS Release 6 — Installation and Test for Multi-Carrier Cabinets, Issue 4, 555-230-112***

Provides procedures and information for hardware installation and initial testing of multi-carrier cabinets.

***DEFINITY ECS Release 6 — Installation and Test for Compact Modular Cabinets, Issue 2, 555-230-128***

Provides procedures and information for hardware installation and initial testing of compact modular cabinets.

***DEFINITY ECS Release 6 — Installation for Adjuncts and Peripherals, Issue 3, 555-230-125***

Provides procedures and information for hardware installation and initial testing of ECS adjunct and peripheral systems and equipment.

***DEFINITY ECS Release 6 — Upgrades and Additions for R6r, Issue 4, 555-230-121***

Provides procedures for an installation technician to convert an existing Generic 3 Version 4 DEFINITY Communications System to DEFINITY ECS and from DEFINITY ECS Release 5 to DEFINITY ECS Release 6.

Included are upgrade considerations, lists of required hardware, and step-by-step upgrade procedures. Also included are procedures to add control carriers, switch node carriers, port carriers, circuit packs, auxiliary cabinets, and other equipment.

***DEFINITY ECS Release 6 — Upgrades and Additions for R6vs/si, Issue 4, 555-230-120***

Provides procedures for an installation technician to convert an existing DEFINITY Communications System Generic 3 Version 4 to DEFINITY ECS and from DEFINITY ECS Release 5 to DEFINITY ECS Release 6.

Included are upgrade considerations, lists of required hardware, and step-by-step upgrade procedures. Also included are procedures to add control carriers, switch node carriers, port carriers, circuit packs, auxiliary cabinets, and other equipment.

***DEFINITY ECS Release 6 — Maintenance for R6r, Issue 2, 555-230-126***

Provides detailed descriptions of the procedures for monitoring, testing, troubleshooting, and maintaining the R6r ECS. Included are maintenance commands, step-by-step trouble-clearing procedures, the procedures for using all tests, and explanations of the system's error codes.

***DEFINITY ECS Release 6 — Maintenance for R6vs/si, Issue 2, 555-204-127***



Provides detailed descriptions of the procedures for monitoring, testing, troubleshooting, and maintaining the R6vs/si ECS. Included are maintenance commands, step-by-step trouble-clearing procedures, the procedures for using all tests, and explanations of the system's error codes.

***DEFINITY ECS Release 6 — Maintenance for R6csi (Compact Modular Cabinets), Issue 2, 555-204-129***

Provides detailed descriptions of the procedures for monitoring, testing, troubleshooting, and maintaining the R6csi ECS. Included are maintenance commands, step-by-step trouble-clearing procedures, the procedures for using all tests, and explanations of the system's error codes.

***DEFINITY ECS — International Telephone Guide Builder, Issue 1, 555-230-742***

Same as 555-230-755 above but customized for international locations.

## **Call Center Documents**

---

These documents are issued for DEFINITY ECS Call Center applications.

### **DEFINITY**

***DEFINITY ECS Release 6 — Call Vectoring/EAS Guide, Issue 1, 585-230-521***

Provides information on how to write, use, and troubleshoot vectors, which are command sequences that process telephone calls in an Automatic Call Distribution (ACD) environment. This document applies to Release 6 as well as earlier DEFINITY systems.

It is provided in two parts: tutorial and reference. The tutorial provides step-by-step procedures for writing and implementing basic vectors. The reference includes detailed descriptions of the call vectoring features, vector management, vector administration, adjunct routing, troubleshooting, and interactions with management information systems (including the Call Management System).

***DEFINITY ECS Release 6 — Basic Call Management System (BCMS) Operations, Issue 1, 555-230-706***

Provides detailed instructions on how to generate reports and manage the system. It is intended for telecommunications managers who wish to use BCMS (Basic Call Management System) reports and for system managers responsible for maintaining the system. This documentation applies to Release 6 as well as earlier DEFINITY systems.

## CentreVu CMS

***CentreVu Call Management System Release 3 Version 5 — Administration, Issue 1, 585-215-820***

***CentreVu Call Management System Release 3 Version 5 — Reports, Issue 1, 585-215-821***

***CentreVu Call Management System Release 3 Version 5 — Custom Reports, Issue 1, 585-215-822***

***CentreVu Call Management System Release 3 Version 5 — Upgrades and Migrations, Issue 3, 585-215-826***

***CentreVu Call Management System Release 3 Version 5 — External Call History Reference, Issue 1, 585-215-824***

***CentreVu Call Management System Release 3 Version 5 — Forecast, Issue 1, 585-215-825***

## Application-Specific Documents

These documents support specific DEFINITY applications.

***DEFINITY ECS Generic 2 to Release 5 — Transition Reference, Issue 1, 555-230-523***

Provides information on the differences in features and administration between the old and new systems when upgrading from a Generic 2 system to DEFINITY ECS Release 5.

## ASAI

***DEFINITY ECS Release 6 — CallVisor ASAI Planning Guide, Issue 4, 555-230-222***

Provides procedures and directions for the account team and customer personnel for effectively planning and implementing the CallVisor Adjunct/Switch Application Interface (ASAI) PBX-Host environment. The CallVisor ASAI is a communications interface that allows adjunct processors to access switch features and to control switch calls. It is implemented using an Integrated Services Digital Network (ISDN) Basic Rate Interface (BRI). Hardware and software requirements are included.

***DEFINITY ECS Release 6 — CallVisor ASAI Protocol Reference, Issue 7, 555-230-221***

Provides detailed layer 3 protocol information regarding the CallVisor Adjunct/Switch Application Interface (ASAI) for the systems and is intended for the library or driver programmer of an adjunct processor to create the library of commands used by the applications programmers. Describes the ISDN message, facility information elements, and information elements.

***DEFINITY ECS Release 6 — CallVisor ASAI Technical Reference, Issue 7, 555-230-220***

Provides detailed information regarding the CallVisor Adjunct/Switch Application Interface (ASAI) for the systems and is intended for the application designer responsible for building and/or programming custom applications and features.

***DEFINITY ECS Release 6 — CallVisor ASAI DEFINITY LAN Gateway over MAP-D Installation, Administration, and Maintenance of, Issue 1, 555-230-114***

Provides procedures for installation, administration, and maintenance of the CallVisor Adjunct/Switch Application Interface (ASAI) Ethernet application over the DEFINITY LAN Gateway and is intended for system administrators, telecommunications managers, Management Information System (MIS) managers, LAN managers, and Lucent personnel. The ASAI-Ethernet application provides ASAI functionality using 10Base-T Ethernet rather than BRI as a transport media.

***DEFINITY ECS Release 6 — CallVisor ASAI PC LAN over MAP-D Installation, Administration, and Maintenance of, Issue 1, 555-230-113***

Provides procedures for installation, administration, and maintenance of the CallVisor Adjunct/Switch Application Interface (ASAI) Ethernet application over the PC LAN and is intended for system administrators, telecommunications managers, Management Information System (MIS) managers, LAN managers, and Lucent personnel. The ASAI-Ethernet application provides ASAI functionality using 10Base-T Ethernet rather than BRI as a transport media.

***DEFINITY ECS Release 6 — Call Visor ASAI Overview, Issue 2, 555-230-225***

Provides a general description of Call Visor ASAI.

This document is available in the following languages: English, German (DE), Dutch (NL), Brazilian Portuguese (PTB), European French (FR), Colombian Spanish (SPL), and Japanese (JA). To order, append the language suffix to the document number; for example, 555-230-894DE for German. No suffix is needed for the English version.

***DEFINITY ECS Release 6 — CallVisor PC ASAI Installation and Reference, Issue 3, 555-230-227***

Provides procedural and reference information for installers, Tier 3 support personnel, and application designers.

## ACD

### ***DEFINITY ECS Release 6 — Automatic Call Distribution (ACD) Agent Instructions, Issue 5, 555-230-722***

Provides information for use by agents after they have completed ACD training. Includes descriptions of ACD features and the procedures for using them.

### ***DEFINITY ECS Release 6 — Automatic Call Distribution (ACD) Supervisor Instructions, Issue 4, 555-230-724***

Provides information for use by supervisors after they have completed ACD training. Includes descriptions of ACD features and the procedures for using them.

## Call Detail Recording

### ***Call Detail Acquisition & Processing Reference, Issue 2, 555-006-202***

Provides a general technical description of the ECS call detail recording feature and of the products that collect, store, poll, and process call records.

## Console Operations

### ***DEFINITY ECS Console Operations, Issue 3, 555-230-700***

Provides operating instructions for the attendant console. Included are descriptions of the console control keys and functions, call-handling procedures, basic system troubleshooting information, and routine maintenance procedures.

### ***DEFINITY ECS Release 6 — Console Operations Quick Reference, Issue 2, 555-230-890***

Provides operating instructions for the attendant console. Included are descriptions of the console control keys and functions, call handling, basic system-troubleshooting information, and routine maintenance procedures.

This document is available in the following languages: English, German (DE), Dutch (NL), Brazilian Portuguese (PTB), European French (FR), Colombian Spanish (SPL), and Japanese (JA). To order, append the language suffix to the document number; for example, 555-230-894DE for German. No suffix is needed for the English version.

## Hospitality

### ***An Introduction to DEFINITY Communications System Generic 3 Hospitality Services, Issue 1, 555-230-021***

Provides an overview of the features available for use by the lodging and health industries to improve their property management and to provide assistance to their employees and clients. Included are brief definitions of many of the system features, descriptions of the hardware, planning considerations, and list of the system capabilities. This documentation also applies to Release 6.

***DEFINITY ECS Release 6 — Hospitality Operations, Issue 4, 555-230-723***

Provides step-by-step procedures for using the features available for the lodging and health industries to improve their property management and to provide assistance to their employees and clients. Includes detailed descriptions of reports.

## Documents on CD-ROM

---

The following CD-ROMs are available from the Publications Center.

***Administration and Call Center CD-ROM, Issue 3, 555-230-828***

Includes the documents listed in the Administration, Call Center, Console Operations, and Hospitality sections above.

***DEFINITY ECS Release 6 Documentation Library CD-ROM, Issue 1, 555-230-833***

A comprehensive set of DEFINITY documentation. Includes the documents in the Administration and Call Center CD-ROM *and* the documents listed in the Installation and Maintenance sections above.

# Glossary and Abbreviations

---

## Numerics

### 800 service

A service in the United States that allows incoming calls from certain areas to an assigned number for a flat-rate charge based on usage.

---

## A

### AA

Archangel. See [angel](#).

### AAC

ATM access concentrator

### AAR

See [Automatic Alternate Routing \(AAR\)](#).

### abandoned call

An incoming call in which the caller hangs up before the call is answered.

### Abbreviated Dialing (AD)

A feature that allows callers to place calls by dialing just one or two digits.

### AC

1. Alternating current.
2. See [Administered Connection \(AC\)](#).

### AAR

Automatic Alternate Routing

### ACA

See [Automatic Circuit Assurance \(ACA\)](#).

### ACB

See [Automatic Callback \(ACB\)](#).

### ACD

See [Automatic Call Distribution \(ACD\)](#).

### ACD agent

See [agent](#).

### ACU

See [Automatic calling unit \(ACU\)](#)

### ACW

See [after-call work \(ACW\) mode](#).

### access code

A 1-, 2-, or 3-digit dial code used to activate or cancel a feature, or access an outgoing trunk.

**access endpoint**

Either a nonsignaling channel on a DS1 interface or a nonsignaling port on an analog tie-trunk circuit pack that is assigned a unique extension.

**access tie trunk**

A trunk that connects a main communications system with a tandem communications system in an electronic tandem network (ETN). An access tie trunk can also be used to connect a system or tandem to a serving office or service node. Also called access trunk.

**access trunk**

See [access tie trunk](#).

**ACCUNET**

A trademarked name for a family of digital services offered by AT&T in the United States.

**ACD**

See [Automatic Call Distribution \(ACD\)](#). ACD also refers to a work state in which an agent is on an ACD call.

**ACD work mode**

See [work mode](#).

**active-notification association**

A link that is initiated by an adjunct, allowing it to receive event reports for a specific switch entity, such as an outgoing call.

**active-notification call**

A call for which event reports are sent over an active-notification association (communication channel) to the adjunct. Sometimes referred to as a monitored call.

**active notification domain**

VDN or ACD split extension for which event notification has been requested.

**ACU**

See [Automatic calling unit \(ACU\)](#).

**AD**

See [Abbreviated Dialing \(AD\)](#).

**ADAP**

AUDIX Data Acquisition Package

**ADC**

See [analog-to-digital converter \(ADC\)](#).

**adjunct**

A processor that does one or more tasks for another processor and that is optional in the configuration of the other processor. See also [application](#).

**adjunct-control association**

A relationship initiated by an application via *Third Party Make Call*, the *Third Party Take Control*, or *Domain (Station) Control* capabilities to set up calls and control calls already in progress.

**adjunct-controlled call**

Call that can be controlled using an adjunct-control association. Call must have been originated via *Third Party Make Call* or *Domain (Station) Control* capabilities or must have been taken control of via *Third Party Take Control* or *Domain (Station) Control* capabilities.



**adjunct-controlled split**

An ACD split that is administered to be under adjunct control. Agents logged into such splits must do all telephony work, ACD login/ logout, and changes of work mode through the adjunct (except for auto-available adjunct-controlled splits, whose agents may not log in/out or change work mode).

**adjunct-monitored call**

An adjunct-controlled call, active-notification call, or call that provides event reporting over a domain-control association.

**Adjunct-Switch Application Interface (ASAI)**

A recommendation for interfacing adjuncts and communications systems, based on the CCITT Q.932 specification for layer 3.

**ADM**

Asynchronous data module

**administer**

To access and change parameters associated with the services or features of a system.

**Administered Connection (AC)**

A feature that allows the switch to automatically establish and maintain end-to-end connections between access endpoints (trunks) and/or data endpoints (data modules).

**administration group**

See [capability group](#).

**administration terminal**

A terminal that is used to administer and maintain a system. See also [terminal](#).

**Administration Without Hardware (AWOH)**

A feature that allows administration of ports without associated terminals or other hardware.

**ADU**

See [asynchronous data unit \(ADU\)](#).

**AE**

See [access endpoint](#).

**after-call work (ACW) mode**

A mode in which agents are unavailable to receive ACD calls. Agents enter the ACW mode to perform ACD-related activities such as filling out a form after an ACD call.

**AG**

ASAI Gateway

**agent**

A person who receives calls directed to a split. A member of an ACD hunt group or ACD split. Also called an ACD agent.

**agent report**

A report that provides historical traffic information for internally measured agents.

**AIM**

Asynchronous interface module

**AIOD**

Automatic Identification of Outward Dialing

**ALBO**

Automatic Line Build Out

**All trunks busy (ATB)**

The state in which no trunks are available for call handling.

**ALM-ACK**

Alarm acknowledge

**American Standard Code for Information Interchange**

See [ASCII \(American Standard Code for Information Interchange\)](#).

**AMW**

Automatic Message Waiting

**AN**

Analog

**analog**

The representation of information by continuously variable physical quantities such as amplitude, frequency, and phase. See also [digital](#).

**analog data**

Data that is transmitted over a digital facility in analog (PCM) form. The data must pass through a modem either at both ends or at a modem pool at the distant end.

**analog telephone**

A telephone that receives acoustic voice signals and sends analog electrical signals along the telephone line. Analog telephones are usually served by a single wire pair (tip and ring). The model-2500 telephone set is a typical example of an analog telephone.

**analog-to-digital converter (ADC)**

A device that converts an analog signal to digital form. See also [digital-to-analog converter \(DAC\)](#).

**angel**

A microprocessor located on each port card in a processor port network (PPN). The angel uses the control-channel message set (CCMS) to manage communications between the port card and the archangel on the controlling switch-processing element (SPE). The angel also monitors the status of other microprocessors on a port card and maintains error counters and thresholds.

**ANI**

See [Automatic Number Identification \(ANI\)](#).

**ANSI**

American National Standards Institute. A United States professional/technical association supporting a variety of standards.

**answerback code**

A number used to respond to a page from a code-calling or loudspeaker-paging system, or to retrieve a parked call.

**AOL**

Attendant-offered load

**AP**

Applications processor

**APLT**

Advanced Private-Line Termination

**appearance**

A software process that is associated with an extension and whose purpose is to supervise a call. An extension can have multiple appearances. Also called call appearance, line appearance, and occurrence. See also [call appearance](#).

**application**

An adjunct that requests and receives ASAI services or capabilities. One or more applications can reside on a single adjunct. However, the switch cannot distinguish among several applications residing on the same adjunct and treats the adjunct, and all resident applications, as a single application. The terms application and adjunct are used interchangeably throughout this document.

**applications processor**

A micro-computer based, program controlled computer providing application services for the DEFINITY switch. The processor is used with several user-controlled applications such as traffic analysis and electronic documentation.

**application service element**

See [capability group](#).

**architecture**

The organizational structure of a system, including hardware and software.

**ARS**

See [Automatic Route Selection \(ARS\)](#).

**ASAI**

See [Adjunct-Switch Application Interface \(ASAI\)](#)

**ASCII (American Standard Code for Information Interchange)**

The standard code for representing characters in digital form. Each character is represented by an 8-bit code (including parity bit).

**association**

A communication channel between adjunct and switch for messaging purposes. An active association is one that applies to an existing call on the switch or to an extension on the call.

**asynchronous data transmission**

A method of transmitting data in which each character is preceded by a start bit and followed by a stop bit, thus permitting data characters to be transmitted at irregular intervals. This type transmission is advantageous when transmission is not regular (characters typed at a keyboard). Also called asynchronous transmission. See also [synchronous data transmission](#).

**asynchronous data unit (ADU)**

A device that allows direct connection between RS-232C equipment and a digital switch.

**Asynchronous Transfer Mode (ATM)**

A packet-like switching technology in which data is transmitted in fixed-size (53-byte) cells. ATM provides high-speed access for data communication in LAN, campus, and WAN environments.

**ATB**

See [All trunks busy \(ATB\)](#).

**ATD**

See [Attention dial \(ATD\)](#).

**attendant**

A person at a console who provides personalized service for incoming callers and voice-services users by performing switching and signaling operations. See also [attendant console](#).

## **ATM**

See [Asynchronous Transfer Mode \(ATM\)](#).

## **attendant console**

The workstation used by an attendant. The attendant console allows the attendant to originate a call, answer an incoming call, transfer a call to another extension or trunk, put a call on hold, and remove a call from hold. Attendants using the console can also manage and monitor some system operations. Also called console. See also [attendant](#).

## **Attention dial (ATD)**

A command in the Hayes modem command set for asynchronous modems.

## **Audio Information Exchange (AUDIX)**

A fully integrated voice-mail system. Can be used with a variety of communications systems to provide call-history data, such as subscriber identification and reason for redirection.

## **AUDIX**

See [Audio Information Exchange \(AUDIX\)](#).

## **auto-in trunk group**

Trunk group for which the CO processes all of the digits for an incoming call. When a CO seizes a trunk from an auto-in trunk group, the switch automatically connects the trunk to the destination — typically an ACD split where, if no agents are available, the call goes into a queue in which callers are answered in the order in which they arrive.

## **Auto-In Work mode**

One of four agent work modes: the mode in which an agent is ready to process another call as soon as the current call is completed.

## **Automatic Alternate Routing (AAR)**

A feature that routes calls to other than the first-choice route when facilities are unavailable.\*\*\*

## **Automatic Callback (ACB)**

A feature that enables internal callers, upon reaching a busy extension, to have the system automatically connect and ring both parties when the called party becomes available.

## **Automatic Call Distribution (ACD)**

A feature that answers calls, and then, depending on administered instructions, delivers messages appropriate for the caller and routes the call to an agent when one becomes available.

## **Automatic Call Distribution (ACD) split**

A method of routing calls of a similar type among agents in a call center. Also, a group of extensions that are staffed by agents trained to handle a certain type of incoming call.

## **Automatic calling unit (ACU)**

A device that places a telephone call.

## **Automatic Circuit Assurance (ACA)**

A feature that tracks calls of unusual duration to facilitate troubleshooting. A high number of very short calls or a low number of very long calls may signify a faulty trunk.

## **Automatic Number Identification (ANI)**

Representation of the calling number, for display or for further use to access information about the caller.

**automatic restoration**

A service that restores disrupted connections between access endpoints (nonsignaling trunks) and data endpoints (devices that connect the switch to data terminal and/or communications equipment). Restoration is done within seconds of a service disruption so that critical data applications can remain operational.

**Automatic Route Selection (ARS)**

A feature that allows the system to automatically choose the least-cost way to send a toll call.

**automatic trunk**

A trunk that does not require addressing information because the destination is predetermined. A request for service on the trunk, called a seizure, is sufficient to route the call. The normal destination of an automatic trunk is the communications-system attendant group. Also called automatic incoming trunk and automatic tie trunk.

**AUX**

Auxiliary

**auxiliary equipment**

Equipment used for optional system features, such as Loudspeaker Paging and Music-on-Hold.

**auxiliary trunk**

A trunk used to connect auxiliary equipment, such as radio-paging equipment, to a communications system.

**Aux-Work mode**

A work mode in which agents are unavailable to receive ACD calls. Agents enter Aux-Work mode when involved in non-ACD activities such as taking a break, going to lunch, or placing an outgoing call.

**AVD**

Alternate voice/data

**AWOH**

See [Administration Without Hardware \(AWOH\)](#).

**AWG**

American Wire Gauge

**AWT**

Average work time

---

## B

**B8ZS**

Bipolar Eight Zero Substitution.

**bandwidth**

The difference, expressed in hertz, between the defined highest and lowest frequencies in a range.

**barrier code**

A security code used with the Remote Access feature to prevent unauthorized access to the system.

**Basic Rate Interface (BRI)**

A standard ISDN frame format that specifies the protocol used between two or more communications systems. BRI runs at 192 Mbps and provides two 64-kbps B-channels (voice and data) and one 16-kbps D-channel (signaling). The D-channel connects, monitors, and disconnects all calls. It also can carry low-speed packet data at 9.6 kbps.

**baud**

A unit of transmission rate equal to the number of signal events per second. See also [bit rate](#) and [bits per second \(bps\)](#).

**BCC**

See [Bearer capability class \(BCC\)](#).

**BCMS**

Basic Call Management System

**BCT**

See [business communications terminal \(BCT\)](#).

**Bearer capability class (BCC)**

Code that identifies the type of a call (for example, voice and different types of data). Determination of BCC is based on the caller's characteristics for non-ISDN endpoints and on the Bearer Capability and Low-Layer Compatibility Information Elements of an ISDN endpoint. Current BCCs are 0 (voice-grade data and voice), 1 (DMI mode 1, 56 kbps data transmission), 2 (DMI mode 2, synchronous/asynchronous data transmission up to 19.2 kbps) 3 (DMI mode 3, 64 kbps circuit/packet data transmission), 4 (DMI mode 0, 64 kbps synchronous data), 5 (temporary signaling connection, and 6 (wideband call, 128–1984 kbps synchronous data).

**BER**

Bit error rate

**BHCC**

Busy-hour call completions

**bit (binary digit)**

One unit of information in binary notation, having two possible values: 0 or 1.

**bits per second (bps)**

The number of binary units of information that are transmitted or received per second. See also [baud](#) and [bit rate](#).

**bit rate**

The speed at which bits are transmitted, usually expressed in bits per second. Also called data rate. See also [baud](#) and [bits per second \(bps\)](#).

**BLF**

Busy Lamp Field

**BN**

Billing number

**BOS**

Bit-oriented signaling

**BPN**

Billed-party number

**bps**

See [bits per second \(bps\)](#).

**bridge (bridging)**

The appearance of a voice terminal's extension at one or more other voice terminals.

**BRI**

The ISDN Basic Rate Interface specification.

**bridged appearance**

A call appearance on a voice terminal that matches a call appearance on another voice terminal for the duration of a call.

**BTU**

British Thermal Unit

**buffer**

1. In hardware, a circuit or component that isolates one electrical circuit from another. Typically, a buffer holds data from one circuit or process until another circuit or process is ready to accept the data.
2. In software, an area of memory that is used for temporary storage.

**bus**

A multiconductor electrical path used to transfer information over a common connection from any of several sources to any of several destinations.

**business communications terminal (BCT)**

A digital data terminal used for business applications. A BCT can function via a data module as a special-purpose terminal for services provided by a processor or as a terminal for data entry and retrieval.

**BX.25**

A version of the CCITT X.25 protocol for data communications. BX.25 adds a fourth level to the standard X.25 interface. This uppermost level combines levels 4, 5, and 6 of the ISO reference model.

**bypass tie trunks**

A 1-way, outgoing tie trunk from a tandem switch to a main switch in an ETN. Bypass tie trunks, provided in limited quantities, are used as a last-choice route when all trunks to another tandem switch are busy. Bypass tie trunks are used only if all applicable intertandem trunks are busy.

**byte**

A sequence of (usually eight) bits processed together.

---

## C

**cabinet**

Housing for racks, shelves, or carriers that hold electronic equipment.

**cable**

Physical connection between two pieces of equipment (for example, data terminal and modem) or between a piece of equipment and a termination field.

**cable connector**

A jack (female) or plug (male) on the end of a cable. A cable connector connects wires on a cable to specific leads on telephone or data equipment.

**CACR**

Cancellation of Authorization Code Request

## **CAG**

Coverage answer group

## **call appearance**

1. For the attendant console, six buttons, labeled a–f, used to originate, receive, and hold calls. Two lights next to the button show the status of the call appearance.
2. For the voice terminal, a button labeled with an extension and used to place outgoing calls, receive incoming calls, or hold calls. Two lights next to the button show the status of the call appearance.

## **call-control capabilities**

Capabilities (*Third Party Selective Hold, Third Party Reconnect, Third Party Merge*) that can be used in either of the Third Party Call Control ASE (cluster) subsets (Call Control and Domain Control).

## **Call Detail Recording (CDR)**

A feature that uses software and hardware to record call data (same as CDRU).

## **Call Detail Recording utility (CDRU)**

Software that collects, stores, optionally filters, and outputs call-detail records.

## **Call Management System (CMS)**

An application, running on an adjunct processor, that collects information from an ACD unit. CMS enables customers to monitor and manage telemarketing centers by generating reports on the status of agents, splits, trunks, trunk groups, vectors, and VDNs, and enables customers to partially administer the ACD feature for a communications system.

## **call-reference value (CRV)**

An identifier present in ISDN messages that associates a related sequence of messages. In ASAI, CRVs distinguish between associations.

## **call vector**

A set of up to 15 vector commands to be performed for an incoming or internal call.

## **callback call**

A call that automatically returns to a voice-terminal user who activated the Automatic Callback or Ringback Queuing feature.

## **call-waiting ringback tone**

A low-pitched tone identical to ringback tone except that the tone decreases in the last 0.2 seconds (in the United States). Call-waiting ringback tone notifies the attendant that the Attendant Call Waiting feature is activated and that the called party is aware of the waiting call. Tones in international countries may sound different.

## **call work code**

A number, up to 16 digits, entered by ACD agents to record the occurrence of customer-defined events (such as account codes, social security numbers, or phone numbers) on ACD calls.

## **CAMA**

Centralized Automatic Message Accounting

## **carrier**

An enclosed shelf containing vertical slots that hold circuit packs.

## **carried load**

The amount of traffic served by traffic-sensitive facilities during a given interval.

## **CARR-POW**

Carrier Port and Power Unit for AC Powered Systems



## CAS

Centralized Attendant Service or Call Accounting System

## capability

A request or indication of an operation. For example, *Third Party Make Call* is a request for setting up a call; *event report* is an indication that an event has occurred.

## capability group

Set of capabilities, determined by switch administration, that can be requested by an application. Capability groups denote association types. For example, *Call Control* is a type of association that allows certain functions (the ones in the capability group) to be performed over this type of association. Also referred to as administration groups or application service elements (ASEs).

## CA-TSC

Call-Associated Temporary Signaling Connection

## cause value

A value is returned in response to requests or in event reports when a denial or unexpected condition occurs. ASAI cause values fall into two coding standards: Coding Standard 0 includes any cause values that are part of AT&T and CCITT ISDN specifications; Coding standard 3 includes any other ASAI cause values. This document uses a notation for cause value where the coding standard for the cause is given first, then a slash, then the cause value. Example: CS0/100 is coding standard 0, cause value 100.

## CBC

Call-by-call or coupled bonding conductor

## CC

Country code

## CCIS

Common-Channel Interoffice Signaling

## CCITT

CCITT (Comite Consultatif International Telephonique et Telegraphique), now called *International Telecommunications Union* (ITU). See [International Telecommunications Union \(ITU\)](#).

## CCMS

Control-Channel Message Set

## CCS

See [capability](#).

## CCS or hundred call seconds

A unit of call traffic. Call traffic for a facility is scanned every 100 seconds. If the facility is busy, it is assumed to have been busy for the entire scan interval. There are 3600 seconds per hour. The Roman numeral for 100 is the capital letter C. The abbreviation for call seconds is CS. Therefore, 100 call seconds is abbreviated CCS. If a facility is busy for an entire hour, then it is said to have been busy for 36 CCS. See also [Erlang](#).

## CCSA

Common-Control Switching Arrangement

## CDM

Channel-division multiplexing

## CDOS

Customer-dialed and operator serviced

**CDPD**

Customer database-provided digits

**CDR**

See [Call Detail Recording \(CDR\)](#).

**CDRP**

Call Detail Record Poller

**CDRR**

Call Detail Recording and Reporting

**CDRU**

See [Call Detail Recording utility \(CDRU\)](#).

**CED**

Caller entered digits

**CEM**

Channel-expansion multiplexing

**center-stage switch (CSS)**

The central interface between the processor port network and expansion port networks in a CSS-connected system.

**central office (CO)**

The location housing telephone switching equipment that provides local telephone service and access to toll facilities for long-distance calling.

**central office (CO) codes**

The first three digits of a 7-digit public-network telephone number in the United States.

**central office (CO) trunk**

A telecommunications channel that provides access from the system to the public network through the local CO.

**CEPT1**

European Conference of Postal and Telecommunications Rate 1

**CESID**

Caller's Emergency Service Identification

**channel**

1. A circuit-switched call.
2. A communications path for transmitting voice and data.
3. In wideband, all of the time slots (contiguous or noncontiguous) necessary to support a call. Example: an H0-channel uses six 64-kbps time slots.
4. A DS0 on a T1 or E1 facility not specifically associated with a logical circuit-switched call; analogous to a single trunk.

**channel negotiation**

The process by which the channel offered in the Channel Identification Information Element (CIIE) in the SETUP message is negotiated to be another channel acceptable to the switch that receives the SETUP message and ultimately to the switch that sent the SETUP. Negotiation is attempted only if the CIIE is encoded as *Preferred*. Channel negotiation is not attempted for wideband calls.

**CI**

Clock input

**circuit**

1. An arrangement of electrical elements through which electric current flows.
2. A channel or transmission path between two or more points.

**circuit pack**

A card on which electrical circuits are printed, and IC chips and electrical components are installed. A circuit pack is installed in a switch carrier.

**CISPR**

International Special Committee on Radio Interference

**Class of Restriction (COR)**

A feature that allows up to 96 classes of call-origination and call-termination restrictions for voice terminals, voice-terminal groups, data modules, and trunk groups. See also [Class of Service \(COS\)](#).

**Class of Service (COS)**

A feature that uses a number to specify if voice-terminal users can activate the Automatic Callback, Call Forwarding All Calls, Data Privacy, or Priority Calling features. See also [Class of Restriction \(COR\)](#).

**cm**

Centimeter

**CM**

Connection Manager

**CMC**

Compact Modular Cabinet

**CMDR**

Centralized Message Detail Recording

**CMS**

Call Management System

**CO**

See [central office \(CO\)](#).

**common-control switching arrangement (CCSA)**

A private telecommunications network using dedicated trunks and a shared switching center for interconnecting company locations.

**communications system**

The software-controlled processor complex that interprets dialing pulses, tones, and keyboard characters and makes the proper connections both within the system and external to the system. The communications system itself consists of a digital computer, software, storage device, and carriers with special hardware to perform the connections. A communications system provides voice and data communications services, including access to public and private networks, for telephones and data terminals on a customer's premises. See also [switch](#).

**confirmation tone**

A tone confirming that feature activation, deactivation, or cancellation has been accepted.

**connectivity**

The connection of disparate devices within a single system.

**console**

See [attendant console](#).

**contiguous**

Adjacent DS0s within one T1 or E1 facility or adjacent TDM or fiber time slots. The first and last TDM bus, DS0, or fiber time slots are not considered contiguous (no wraparound). For an E1 facility with a D-channel, DS0s 15 and 17 are considered contiguous.

**control cabinet**

See [control carrier](#).

**control carrier**

A carrier in a multi-carrier cabinet that contains the SPE circuit packs and, unlike an R5r control carrier, port circuit packs. Also called control cabinet in a single-carrier cabinet. See also [switch-processing element \(SPE\)](#).

**controlled station**

A station that is monitored and controlled via a domain-control association.

**COR**

See [Class of Restriction \(COR\)](#).

**COS**

See [Class of Service \(COS\)](#).

**coverage answer group**

A group of up to eight voice terminals that ring simultaneously when a call is redirected to it by Call Coverage. Any one of the group can answer the call.

**coverage call**

A call that is automatically redirected from the called party's extension to an alternate answering position when certain coverage criteria are met.

**coverage path**

The order in which calls are redirected to alternate answering positions.

**coverage point**

An extension or attendant group, VDN, or ACD split designated as an alternate answering position in a coverage path.

**covering user**

A person at a coverage point who answers a redirected call.

**CP**

Circuit pack

**CPE**

Customer-premises equipment

**CPN**

Called-party number

**CPN/BN**

Calling-party number/billing number

**CPTR**

Call-progress-tone receiver

**CRC**

Cyclical Redundancy Checking

**critical-reliability system**

A system that has the following duplicated items: control carriers, tone clocks, EI circuit packs, and cabling between port networks and center-stage switch in a CSS-connected system. See also [duplicated common control](#), and [duplication](#).

**CSA**

Canadian Safety Association or Customer Software Administrator

**CSCC**

Compact single-carrier cabinet

**CSCN**

Center-stage control network

**CSD**

Customer-service document

**CSM**

Centralized System Management

**CSS**

See [center-stage switch \(CSS\)](#).

**CSSO**

Customer Services Support Organization

**CSU**

Channel service unit

**CTS**

Clear to Send

**CWC**

See [call work code](#).

---

## D

**DAC**

1. Dial access code or Direct Agent Calling
2. See [digital-to-analog converter \(DAC\)](#).

**data channel**

A communications path between two points used to transmit digital signals.

**data-communications equipment (DCE)**

The equipment (usually a modem, data module, or packet assembler/disassembler) on the network side of a communications link that makes the binary serial data from the source or transmitter compatible with the communications channel.

**data link**

The configuration of physical facilities enabling end terminals to communicate directly with each other.

**data module**

An interconnection device between a BRI or DCP interface of the switch and data terminal equipment or data communications equipment.

**data path**

The end-to-end connection used for a data communications link. A data path is the combination of all elements of an interprocessor communication in a DCS.

**data port**

A point of access to a computer that uses trunks or lines for transmitting or receiving data.

**data rate**

See [bit rate](#).

**data service unit (DSU)**

A device that transmits digital data on transmission facilities.

**data terminal**

An input/output (I/O) device that has either switched or direct access to a host computer or to a processor interface.

**data terminal equipment (DTE)**

Equipment consisting of the endpoints in a connection over a data circuit. In a connection between a data terminal and host, the terminal, the host, and their associated modems or data modules make up the DTE.

**dB**

Decibel

**dBa**

Decibels in reference to amperes.

**dBnC**

Decibels above reference noise with C filter.

**DC**

Direct current

**DCE**

Data-communications equipment

**D-channel backup**

Type of backup used with Non-Facility Associated Signaling (NFAS). A primary D-channel provides signaling for an NFAS D-channel group (two or more PRI facilities). A second D-channel, on a separate PRI facility of the NFAS D-channel group, is designated as backup for the D-channel. Failure of the primary D-channel causes automatic transfer of call-control signaling to the backup D-channel. The backup becomes the primary D-channel. When the failed channel returns to service, it becomes the backup D-channel.

**DCO**

Digital central office

**DCP**

Digital Communications Protocol

**DCS**

Distributed Communications System

**DDC**

Direct Department Calling

**DDD**

Direct Distance Dialing

**delay-dial trunk**

A trunk that allows dialing directly into a communications system (digits are received as they are dialed).

**denying a request**

Sending a negative acknowledgement (NAK), done by sending an FIE with a *return error* component (and a cause value). It should not be confused with the denial event report that applies to calls.

**designated voice terminal**

The specific voice terminal to which calls, originally directed to a certain extension, are redirected. Commonly used to mean the forwarded-to terminal when Call Forwarding All Calls is active.

**dial-repeating trunks**

A PBX tie trunk that is capable of handling PBX station-signaling information without attendant assistance.

**dial-repeating tie trunk**

A tie trunk that transmits called-party addressing information between two communications systems.

**DID**

Direct Inward Dialing

**digit conversion**

A process used to convert specific dialed numbers into other dialed numbers.

**digital**

The representation of information by discrete steps. See also [analog](#).

**digital communications protocol (DCP)**

- A proprietary protocol used to transmit both digitized voice and digitized data over the same communications link. A DCP link is made up of two 64-kbps information (I-) channels and one 8-kbps signaling (S-) channel. The DCP protocol supports two information-bearing channels, and thus two telephones/data modules. The I1 channel is the DCP channel assigned on the first page of the 8411 station form. The I2 channel is the DCP channel assigned on the analog adjunct page of the 8411 station form or on the data module page.
- Digital Communications Protocol. The DCP protocol supports two information-bearing channels, and thus two telephones/data modules. The I1 channel is the DCP channel assigned on the first page of the 8411 station form. The I2 channel is the DCP channel assigned on the analog adjunct page of the 8411 station form or on the data module page.

**digital data endpoints**

In DEFINITY ECS, devices such as the 510D terminal or the 515-type business communications terminal (BCT).

**digital multiplexed interface (DMI)**

An interface that provides connectivity between a communications system and a host computer or between two communications systems using DS1 24th-channel signaling. DMI provides 23 64-kbps data channels and 1 common-signaling channel over a twisted-pair connection. DMI is offered through two capabilities: bit-oriented signaling (DMI-BOS) and message-oriented signaling (DMI-MOS).

**digital signal level 0 (DS0)**

A single 64-kbps voice channel. A DS0 is a single 64-kbps channel in a T1 or E1 facility and consists of eight bits in a T1 or E1 frame every 125 microseconds.

**digital signal level 1 (DS1)**

A single 1.544-Mbps (United States) or 2.048-Mbps (outside the United States) digital signal carried on a T1 transmission facility. A DS1 converter complex consists of a pair, one at each end, of DS1 converter circuit packs and the associated T1/E1 facilities.

**digital terminal data module (DTDM)**

An integrated or adjunct data module that shares with a digital telephone the same physical port for connection to a communications system. The function of a DTDM is similar to that of a PDM and MPDM in that it converts RS-232C signals to DCP signals.

**digital-to-analog converter (DAC)**

A device that converts data in digital form to the corresponding analog signals. See also [analog-to-digital converter \(ADC\)](#).

**digital transmission**

A mode of transmission in which information to be transmitted is first converted to digital form and then transmitted as a serial stream of pulses.

**digital trunk**

A circuit that carries digital voice and/or digital data in a telecommunications channel.

**DIOD**

Direct Inward and Outward Dialing

**direct agent**

A feature, accessed only via ASAI, that allows a call to be placed in a split queue but routed only to a specific agent in that split. The call receives normal ACD call treatment (for example, announcements) and is measured as an ACD call while ensuring that a particular agent answers.

**Direct Extension Selection (DXS)**

A feature on an attendant console that allows an attendant direct access to voice terminals by pressing a group-select button and a DXS button.

**Direct Inward Dialing (DID)**

A feature that allows an incoming call from the public network (not FX or WATS) to reach a specific telephone without attendant assistance.

**Direct Inward Dialing (DID) trunk**

An incoming trunk used for dialing directly from the public network into a communications system without help from the attendant.

**disk drive**

An electromechanical device that stores data on and retrieves data from one or more disks.

**distributed communications system (DCS)**

A network configuration linking two or more communications systems in such a way that selected features appear to operate as if the network were one system.

**DIVA**

Data In/Voice Answer

**DLC**

Data line circuit

**DLDM**

Data-line data module



**DMI**

Digital-multiplexed interface

**DND**

Do not disturb

**DNIS**

Dialed-Number Identification Service

**DOD**

Direct Outward Dialing

**domain**

VDNs, ACD splits, and stations. The VDN domain is used for active-notification associations. The ACD-split domain is for active-notification associations and domain-control associations. The station domain is used for the domain-control associations.

**domain-control association**

A *Third Party Domain Control Request* capability initiates a unique CRV/link number combination, which is referred to as a domain-control association.

**domain-controlled split**

A split for which *Third Party Domain Control* request has been accepted. A domain-controlled split provides an event report for logout.

**domain-controlled station**

A station for which a *Third\_Party\_Domain\_Control* request has been accepted. A domain-controlled station provides event reports for calls that are alerting, connected, or held at the station.

**domain-controlled station on a call**

A station that is active on a call, and which provides event reports over one or two domain-control associations.

**DOSS**

Delivery Operations Support System

**DOT**

Duplication Option Terminal

**DPM**

Dial Plan Manager

**DPR**

Dual-port RAM

**DS1**

Digital Signal Level 1

**DS1C**

Digital Signal Level-1 protocol C

**DS1 CONV**

Digital Signal Level-1 converter

**DSI**

Digital signal interface

**DSU**

Data service unit

**DTDM**

Digital-terminal data module

**DTE**

Data-terminal equipment

**DTGS**

Direct Trunk Group Select

**DTMF**

Dual-tone multifrequency

**DTS**

Disk-tape system

**deduplicated common control**

Two processors ensuring continuous operation of a communications system. While one processor is online, the other functions as a backup. The backup processor goes online periodically or when a problem occurs.

**duplication**

The use of redundant components to improve availability. When a duplicated subsystem fails, its backup redundant system automatically takes over.

**duplication option**

A system option that duplicates the following: control carrier containing the SPE, EI circuit packs in carriers, fiber-optic cabling between port networks, and center-stage switch in a CSS-connected system.

**DWBS**

DEFINITY Wireless Business System

**DXS**

Direct extension selection

---

**E**

**E1**

A digital transmission standard that carries traffic at 2.048 Mbps. The E1 facility is divided into 32 channels (DS0s) of 64 kbps information. Channel 0 is reserved for framing and synchronization information. A D-channel occupies channel 16.

**E & M**

Ear and mouth (receive and transmit)

**EA**

Expansion archangel

**EAL**

Expansion archangel link

**ear and mouth (E & M) signaling**

Trunk supervisory signaling, used between two communications systems, whereby signaling information is transferred through 2-state voltage conditions (on the E and M leads) for analog applications and through a single bit for digital applications.

**EAS**

See "[Expert Agent Selection](#)".

**ECC**

Error Correct Code

**ECMA**

European Computer Manufacturers Association

**EBCDIC**

Extended Binary-Coded Decimal Interexchange Code

**EPF**

Electronic power feed

**EI**

Expansion interface

**EIA**

Electronic Industries Association

**EIA-232**

A physical interface specified by the EIA. EIA-232 transmits and receives asynchronous data at speeds of up to 19.2 kbps over cable distances of up to 50 feet. EIA-232 replaces RS-232 protocol in some DEFINITY applications.

**electronic tandem network (ETN)**

A tandem tie-trunk network that has automatic call-routing capabilities based on the number dialed and the most preferred route available. Each switch in the network is assigned a unique private network office code (RNX), and each voice terminal is assigned a unique extension.

**Electronics Industries Association (EIA)**

A trade association of the electronics industry that establishes electrical and functional standards.

**emergency transfer**

If a major system failure occurs, automatic transfer is initiated to a group of telephones capable of making outgoing calls. The system operates in this mode until the failure is repaired and the system automatically returns to normal operation. Also called power-failure transfer.

**EMI**

Electromagnetic interference

**end-to-end signaling**

The transmission of touch-tone signals generated by dialing from a voice terminal to remote computer equipment. These digits are sent over the trunk as DTMF digits whether the trunk signaling type is marked as tone or rotary and whether the originating station is tone or rotary. Example: a call to a voice-mail machine or automated-attendant service. A connection is first established over an outgoing trunk. Then additional digits are dialed to transmit information to be processed by the computer equipment.

**enhanced private-switched communications service (EPSCS)**

An analog private telecommunications network based on the No. 5 crossbar and 1A ESS that provides advanced voice and data telecommunications services to companies with many locations.

**EPN**

Expansion-port network

**EPROM**

Erasable programmable read-only memory

**EPSCS**

Enhanced Private Switched Communications Services

**ERL**

Echo return loss

**Erlang**

A unit of traffic intensity, or load, used to express the amount of traffic needed to keep one facility busy for one hour. One Erlang is equal to 36 CCS. See also [capability](#).

**ESF**

Extended superframe format

**ESPA**

European Standard Paging Access

**ETA**

Extended Trunk Access; also Enhanced Terminal Administration

**ETN**

Electronic tandem network

**ETSI**

European Telecommunications Standards Institute

**expansion archangel (EAA)**

A network-control microprocessor located on an expansion interface (EI) port circuit pack in an expansion port network. The EA provides an interface between the EPN and its controlling switch-processing element.

**expansion-archangel link (EAL)**

A link-access function on the D-channel (LAPD) logical link that exists between a switch-processing element and an expansion archangel (EA). The EAL carries control messages from the SPE to the EA and to port circuit packs in an expansion port network.

**expansion control cabinet**

See [expansion control carrier](#).

**expansion control carrier**

A carrier in a multicarrier cabinet that contains extra port circuit packs and a maintenance interface. Also called expansion control cabinet in a single-carrier cabinet.

**expansion interface (EI)**

A port circuit pack in a port network that provides the interface between a PN's TDM bus/ packet bus and a fiber-optic link. The EI carries circuit-switched data, packet-switched data, network control, timing control, and DS1 control. In addition, an EI in an expansion port network communicates with the master maintenance circuit pack to provide the EPN's environmental and alarm status to the switch-processing element.

**expansion port network (EPN)**

A port network (PN) that is connected to the TDM bus and packet bus of a processor port network (PPN). Control is achieved by indirect connection of the EPN to the PPN via a port-network link (PNL). See also [port network \(PN\)](#).

**Expert Agent Selection**

A feature allowing incoming calls to be routed to specialized groups of agents within a larger pool of agents.

**extension-in**

Extension-In (ExtIn) is the work state agents go into when they answer (receive) a non-ACD call. If the agent is in Manual-In or Auto-In and receives an extension-in call, it is recorded by CMS as an AUX-In call.

**extension-out**

The work state that agents go into when they place (originate) a non-ACD call.

**external measurements**

Those ACD measurements that are made by the External CMS adjunct.

**extension**

A 1- to 5-digit number by which calls are routed through a communications system or, with a Uniform Dial Plan (UDP) or main-satellite dialing plan, through a private network.

**external call**

A connection between a communications system user and a party on the public network or on another communications system in a private network.

---

**F**

**FAC**

Feature Access Code

**facility**

A telecommunications transmission pathway and associated equipment.

**facility-associated signaling (FAS)**

Signaling for which a D-channel carries signaling only for those channels on the same physical interface.

**FAS**

Facility-associated signaling

**FAT**

Facility access trunk

**FAX**

Facsimile

**FCC**

Federal Communications Commission

**FEAC**

Forced Entry of Account Codes

**feature**

A specifically defined function or service provided by the system.

**feature button**

A labeled button on a telephone or attendant console used to access a specific feature.

**FEP**

Front-end processor

**fiber optics**

A technology using materials that transmit ultrawideband electromagnetic light-frequency ranges for high-capacity carrier systems.

**FIC**

Facility interface codes

**fixed**

A trunk allocation term. In the fixed allocation scheme, the time slots necessary to support a wideband call are contiguous, and the first time slot is constrained to certain starting points.

**flexible**

A trunk allocation term. In the flexible allocation scheme, the time slots of a wideband call can occupy noncontiguous positions within a single T1 or E1 facility.

**floating**

A trunk allocation term. In the floating allocation scheme, the time slots of a wideband call are contiguous, but the position of the first time slot is not fixed.

**FNPA**

Foreign Numbering-Plan Area

**foreign-exchange (FX)**

A CO other than the one providing local access to the public telephone network.

**foreign-exchange trunk**

A telecommunications channel that directly connects the system to a CO other than its local CO.

**foreign numbering-plan area code (FNPAC)**

An area code other than the local area code, that must be dialed to call outside the local geographical area.

**FRL**

Facilities Restriction Level

**FX**

Foreign exchange

---

**G**

**G3-MA**

Generic 3 Management Applications

**G3-MT**

Generic 3 Management Terminal

**G3r**

Generic 3, RISC (Reduced Instruction Set Computer)

**generalized route selection (GRS)**

An enhancement to Automatic Alternate Routing/Automatic Route Selection (AAR/ARS) that performs routing based on call attributes, such as Bearer Capability Classes (BCCs), in addition to the address and facilities restriction level (FRL), thus facilitating a Uniform Dial Plan (UDP) that is independent of the type of call being placed.

**glare**

The simultaneous seizure of a 2-way trunk by two communications systems, resulting in a standoff.

## GM

Group manager

## GPTR

General-purpose tone receiver

## grade of service

The number of call attempts that fail to receive service immediately. Grade of service is also expressed as the quantity of all calls that are blocked or delayed.

## ground-start trunk

A trunk on which, for outgoing calls, the system transmits a request for services to a distant switching system by grounding the trunk ring lead. To receive the digits of the called number, that system grounds the trunk tip lead. When the system detects this ground, the digits are sent.

## GRS

Generalized Route Selection

---

# H

## H0

An ISDN information transfer rate for 384-kbps data defined by CCITT and ANSI standards.

## H11

An ISDN information transfer rate for 1536-kbps data defined by CCITT and ANSI standards.

## H12

An ISDN information transfer rate for 1920-kbps data defined by CCITT and ANSI standards.

## handshaking logic

A format used to initiate a data connection between two data module devices.

## hertz (Hz)

A unit of frequency equal to one cycle per second.

## high-reliability system

A system having the following: two control carriers, duplicate expansion interface (EI) circuit packs in the PPN (in R5r with CSS), and duplicate switch node clock circuit packs in the switch node (SN) carriers. See also [duplicated common control](#), [duplication](#), [duplication option](#), and [critical-reliability system](#).

## HNPA

See [home numbering-plan area code \(HNPA\)](#).

## holding time

The total length of time in minutes and seconds that a facility is used during a call.

## home numbering-plan area code (HNPA)

The local area code. The area code does not have to be dialed to call numbers within the local geographical area.

## hop

Nondirect communication between two switch communications interfaces (SCI) where the SCI message passes automatically without intermediate processing through one or more intermediate SCIs.

**host computer**

A computer, connected to a network, that processes data from data-entry devices.

**hunt group**

A group of extensions that are assigned the Station Hunting feature so that a call to a busy extension reroutes to an idle extension in the group. See also [ACD work mode](#).

**Hz**

See [hertz \(Hz\)](#).



**I**

**I1**

The first information channel of DCP.

**I2**

The second information channel of DCP.

**I2 Interface**

A proprietary interface used for the DEFINITY Wireless Business System for the radio-controller circuit packs. Each interface provides communication between the radio-controller circuit pack and up to two wireless fixed bases.

**I3 Interface**

A proprietary interface used for the DEFINITY Wireless Business System for the cell antenna units. Each wireless fixed base can communicate to up to four cell antenna units.

**IAS**

Inter-PBX Attendant Service

**ICC**

Intercabinet cable or intercarrier cable

**ICD**

Inbound Call Director

**ICDOS**

International Customer-Dialed Operator Service

**ICHT**

Incoming call-handling table

**ICI**

Incoming call identifier

**ICM**

Inbound Call Management

**IDDD**

International Direct Distance Dialing

**IDF**

Intermediate distribution frame

**IE**

Information element



**immediate-start tie trunk**

A trunk on which, after making a connection with a distant switching system for an outgoing call, the system waits a nominal 65 ms before sending the digits of the called number. This allows time for the distant system to prepare to receive digits. On an incoming call, the system has less than 65 ms to prepare to receive the digits.

**IMT**

Intermachine trunk

**in**

Inch

**INADS**

Initialization and Administration System

**incoming gateway**

A PBX that routes an incoming call on a trunk *not* administered for Supplementary Services Protocol B to a trunk *not* administered for Supplementary Services Protocol B.

**information exchange**

The exchange of data between users of two different systems, such as the switch and a host computer, over a LAN.

**Information Systems Network (ISN)**

A WAN and LAN with an open architecture combining host computers, minicomputers, word processors, storage devices, PCs, high-speed printers, and nonintelligent terminals into a single packet-switching system.

**INS**

ISDN Network Service

**inside call**

A call placed from one telephone to another within the local communications system.

**Integrated Services Digital Network (ISDN)**

A public or private network that provides end-to-end digital communications for all services to which users have access by a limited set of standard multipurpose user-network interfaces defined by the CCITT. Through internationally accepted standard interfaces, ISDN provides digital circuit-switched or packet-switched communications within the network and links to other ISDNs to provide national and international digital communications. See also [Integrated Services Digital Network Basic Rate Interface \(ISDN-BRI\)](#) and [Integrated Services Digital Network Primary Rate Interface \(ISDN-PRI\)](#).

**Integrated Services Digital Network Basic Rate Interface (ISDN-BRI)**

The interface between a communications system and terminal that includes two 64-kbps B-channels for transmitting voice or data and one 16-kbps D-channel for transmitting associated B-channel call control and out-of-band signaling information. ISDN-BRI also includes 48 kbps for transmitting framing and D-channel contention information, for a total interface speed of 192 kbps. ISDN-BRI serves ISDN terminals and digital terminals fitted with ISDN terminal adapters. See also [Integrated Services Digital Network \(ISDN\)](#) and [Integrated Services Digital Network Primary Rate Interface \(ISDN-PRI\)](#).

### **Integrated Services Digital Network Primary Rate Interface (ISDN-PRI)**

The interface between multiple communications systems that in North America includes 24 64-kbps channels, corresponding to the North American digital signal level-1 (DS1) standard rate of 1.544 Mbps. The most common arrangement of channels in ISDN-PRI is 23 64-kbps B-channels for transmitting voice and data and 1 64-kbps D-channel for transmitting associated B-channel call control and out-of-band signaling information. With nonfacility-associated signaling (NFAS), ISDN-PRI can include 24 B-channels and no D-channel. See also [Integrated Services Digital Network \(ISDN\)](#) and [Integrated Services Digital Network Basic Rate Interface \(ISDN-BRI\)](#).

### **intercept tone**

A tone that indicates a dialing error or denial of the service requested.

### **interface**

A common boundary between two systems or pieces of equipment.

### **internal call**

A connection between two users within a system.

### **International Telecommunications Union (ITU)**

Formerly known as International Telegraph and Telephone Consultative Committee (CCITT), ITU is an international organization that sets universal standards for data communications, including ISDN. ITU members are from telecommunications companies and organizations around the world. See also [BX.25](#).

### **International Telegraph and Telephone Consultative Committee**

See [International Telecommunications Union \(ITU\)](#).

### **interflow**

The ability for calls to forward to other splits on the same PBX or a different PBX using the Call Forward All Calls feature.

### **intraflow**

The ability for calls to redirect to other splits on the same PBX on a conditional or unconditional basis using call coverage busy, don't answer, or all criteria.

### **internal measurements**

BCMS measurements that are made by the system. ACD measurements that are made external to the system (via External CMS) are referred to as external measurements.

### **in-use lamp**

A red light on a multiappearance voice terminal that lights to show which call appearance will be selected when the handset is lifted or which call appearance is active when a user is off-hook.

### **INWATS**

Inward Wide Area Telephone Service

### **IO**

Information outlet

### **ISDN**

See [Integrated Services Digital Network \(ISDN\)](#).

### **ISDN Gateway (IG)**

A feature allowing integration of the switch and a host-based telemarketing application via a link to a gateway adjunct. The gateway adjunct is a 3B-based product that notifies the host-based telemarketing application of call events.

### **ISDN trunk**

A trunk administered for use with ISDN-PRI. Also called ISDN facility.

**ISDN-PRI terminal adapter**

An interface between endpoint applications and an ISDN PRI facility. ISDN-PRI terminal adapters are currently available from other vendors and are primarily designed for video conferencing applications. Accordingly, currently available terminal adapters adapt the two pairs of video codec data (V.35) and dialing (RS-366) ports to an ISDN PRI facility.

**IS/DTT**

Integrated Services/digital tie trunk

**ISN**

Information Systems Network

**ISO**

International Standards Organization

**ISV**

Independent software vendor

**ITP**

Installation test procedure

**ITU**

International Telecommunications Union

**IXC**

Interexchange carrier code

---

**K**

**kHz**

Kilohertz

**kbps**

Kilobits per second

**kbyte**

Kilobyte

**kg**

Kilogram

---

**L**

**LAN**

Local area network

**LAP-D**

Link Access Procedure on the D-channel

**LAPD**

Link Access Procedure data

**LATA**

Local access and transport area

- lb**  
Pound
- LBO**  
Line buildout
- LDN**  
Listed directory number
- LDS**  
Long-distance service
- LEC**  
Local exchange carrier
- LED**  
See [light-emitting diode \(LED\)](#).
- light-emitting diode (LED)**  
A semiconductor device that produces light when voltage is applied. LEDs provide a visual indication of the operational status of hardware components, the results of maintenance tests, the alarm status of circuit packs, and the activation of telephone features.
- lightwave transceiver**  
Hardware that provides an interface to fiber-optic cable from port circuit packs and DS1 converter circuit packs. Lightwave transceivers convert electrical signals to light signals and vice versa.
- line**  
A transmission path between a communications system or CO switching system and a voice terminal or other terminal.
- line appearance**  
See [appearance](#).
- line buildout**  
A selectable output attenuation is generally required of DTE equipment because T1 circuits require the last span to lose 15–22.5 dB.
- line port**  
Hardware that provides the access point to a communications system for each circuit associated with a telephone or data terminal.
- link**  
A transmitter-receiver channel that connects two systems.
- link-access procedure on the D-channel (LAPD)**  
A link-layer protocol on the ISDN-BRI and ISDN-PRI data-link layer (level 2). LAPD provides data transfer between two devices, and error and flow control on multiple logical links. LAPD is used for signaling and low-speed packet data (X.25 and mode 3) on the signaling (D-) channel and for mode-3 data communications on a bearer (B-) channel.
- LINL**  
Local indirect neighbor link
- local area network (LAN)**  
A networking arrangement designed for a limited geographical area. Generally, a LAN is limited in range to a maximum of 6.2 miles and provides high-speed carrier service with low error rates. Common configurations include daisy chain, star (including circuit-switched), ring, and bus.

**logical link**

The communications path between a processor and a BRI terminal.

**loop-start trunk**

A trunk on which, after establishing a connection with a distant switching system for an outgoing call, the system waits for a signal on the loop formed by the trunk leads before sending the digits of the called number.

**LSU**

Local storage unit

**LWC**

Leave Word Calling

---

## M

**MAC**

Medium access

**MADU**

Modular asynchronous data unit

**main distribution frame (MDF)**

A device that mounts to the wall inside the system equipment room. The MDF provides a connection point from outside telephone lines to the PBX switch and to the inside telephone stations.

**main-satellite-tributary**

A private network configuration that can either stand alone or access an ETN. A main switch provides interconnection, via tie trunks, with one or more subtending switches, called satellites; all attendant positions for the main/satellite configuration; and access to and from the public network. To a user outside the complex, a main/satellite configuration appears as one switch, with one listed directory number (LDN). A tributary switch is connected to the main switch via tie trunks, but has its own attendant positions and LDN.

**maintenance**

Activities involved in keeping a telecommunications system in proper working condition: the detection and isolation of software and hardware faults, and automatic and manual recovery from these faults.

**management terminal**

The terminal that is used by the system administrator to administer the switch. The terminal may also be used to access the BCMS feature.

**major alarm**

An indication of a failure that has caused critical degradation of service and requires immediate attention. Major alarms are automatically displayed on LEDs on the attendant console and maintenance or alarming circuit pack, logged to the alarm log, and reported to a remote maintenance facility, if applicable.

**Manual-In work mode**

One of four agent work modes: the mode in which an agent is ready to process another call manually. See [Auto-In Work mode](#) for a contrast.

**MAP**

Maintenance action process

**MAPD**

Multiapplication platform for DEFINITY

**MA-UUI**

Message-Associated User-to-User Signaling

**Mbps**

Megabits per second

**M-Bus**

Memory bus

**Mbyte**

Megabyte

**MCC**

Multicarrier cabinet

**MCS**

Message Center Service

**MCT**

Malicious Call Trace

**MCU**

Multipoint control unit

**MDF**

Main distribution frame

**MDM**

Modular data module

**MDR**

Message detail record

**MEM**

Memory

**memory**

A device into which information can be copied and held, and from which information can later be obtained.

**memory shadowing link**

An operating-system condition that provides a method for memory-resident programs to be more quickly accessed, allowing a system to reboot faster.

**message center**

An answering service that supplies agents to and stores messages for later retrieval.

**message center agent**

A member of a message-center hunt group who takes and retrieves messages for voice-terminal users.

**MET**

Multibutton electronic telephone

**MF**  
Multifrequency

**MFB**  
Multifunction board

**MFC**  
Multifrequency code

**MHz**  
Megahertz

**MIM**  
Management information message

**minor alarm**  
An indication of a failure that could affect customer service. Minor alarms are automatically displayed on LEDs on the attendant console and maintenance or alarming circuit pack, sent to the alarm log, and reported to a remote maintenance facility, if applicable.

**MIPS**  
Million instructions per second

**MIS**  
Management information system

**MISCID**  
Miscellaneous identification

**MMCS**  
Multimedia Call Server

**MMCH**  
Multimedia call handling

**MMI**  
Multimedia interface

**MMS**  
Material Management Services

**MO**  
Maintenance object

**modem**  
A device that converts digital data signals to analog signals for transmission over telephone circuits. The analog signals are converted back to the original digital data signals by another modem at the other end of the circuit.

**modem pooling**  
A capability that provides shared conversion resources (modems and data modules) for cost-effective access to analog facilities by data terminals. When needed, modem pooling inserts a conversion resource into the path of a data call. Modem pooling serves both outgoing and incoming calls.

**modular processor data module (MPDM)**  
A processor data module (PDM) that can be configured to provide several kinds of interfaces (RS-232C, RS-449, and V.35) to customer-provided data terminal equipment (DTE). See also [processor data module \(PDM\)](#).

**modular trunk data module (MTDM)**

A trunk data module that can be configured to provide several kinds of interfaces (RS-232, RS-449, and V.35) to customer-provided data terminal equipment.

**modulator-demodulator**

See [modem](#).

**monitored call**

See [active-notification call](#).

**MOS**

Message-oriented signaling

**MPDM**

Modular processor data module

**MS**

Message server

**ms**

Millisecond

**MS/T**

Main satellite/tributary

**MSA**

Message servicing adjunct

**MSG**

Message service

**MSL**

Material stocking location

**MSM**

Modular System Management

**MSS**

Mass storage system

**MSSNET**

Mass storage/network control

**MT**

Management terminal

**MTDM**

Modular trunk data module

**MTP**

Maintenance tape processor

**MTT**

Multitasking terminal

**multiappearance voice terminal**

A terminal equipped with several call-appearance buttons for the same extension, allowing the user to handle more than one call on that same extension at the same time.

**Multicarrier cabinet**

A structure that holds one to five carriers. See also [single-carrier cabinet](#).



**Multifrequency Compelled (MFC) Release 2 (R2) signaling**

A signal consisting of two frequency components, such that when a signal is transmitted from a switch, another signal acknowledging the transmitted signal is received by the switch. R2 designates signaling used in the United States and in countries outside the United States.

**multiplexer**

A device used to combine a number of individual channels into a single common bit stream for transmission.

**multiplexing**

A process whereby a transmission facility is divided into two or more channels, either by splitting the frequency band into a number of narrower bands or by dividing the transmission channel into successive time slots. See also [time-division multiplexing \(TDM\)](#).

**multirate**

The new N x DS0 service (see N x DS0).

**MWL**

Message-waiting lamp

---

## N

**N+1**

Method of determining redundant backup requirements. Example: if four rectifier modules are required for a DC-powered single-carrier cabinet, a fifth rectifier module is installed for backup.

**N x DS0**

N x DS0, equivalently referred to as N x 64 kbps, is an emerging standard for wideband calls separate from H0, H11, and H12 ISDN channels. The emerging N x DS0 ISDN multirate circuit mode bearer service will provide circuit-switched calls with data-rate multiples of 64 kbps up to 1536 kbps on a T1 facility or up to 1920 kbps on an E1 facility. In the switch, N x DS0 channels will range up to 1984 kbps using NFAS E1 interfaces.

**NANP**

North American Numbering Plan

**narrowband**

A circuit-switched call at a data rate up to and including 64 kbps. All nonwideband switch calls are considered narrowband.

**native terminal support**

A predefined terminal type exists in switch software, eliminating the need to alias the terminal (that is, manually map call appearances and feature buttons onto some other natively supported terminal type).

**NAU**

Network access unit

**NCA/TSC**

Noncall-associated/temporary-signaling connection

**NCOSS**

Network Control Operations Support Center

**NCSSO**

National Customer Support Organization

**NEC**

National Engineering Center

**NEMA**

National Electrical Manufacturer's Association

**NETCON**

Network-control circuit pack

**network**

A series of points, nodes, or stations connected by communications channels.

**network-specific facility (NSF)**

An information element in an ISDN-PRI message that specifies which public-network service is used. NSF applies only when Call-by-Call Service Selection is used to access a public-network service.

**network interface**

A common boundary between two systems in an interconnected group of systems.

**NFAS**

See [Nonfacility-associated signaling \(NFAS\)](#).

**NI**

Network interface

**NID**

Network Inward Dialing

**NM**

Network management

**NN**

National number

**node**

A switching or control point for a network. Nodes are either tandem (they receive signals and pass them on) or terminal (they originate or terminate a transmission path).

**Nonfacility-associated signaling (NFAS)**

A method that allows multiple T1 and/or E1 facilities to share a single D-channel to form an ISDN-PRI. If D-channel backup is not used, one facility is configured with a D-channel, and the other facilities that share the D-channel are configured without D-channels. If D-channel backup is used, two facilities are configured to have D-channels (one D-channel on each facility), and the other facilities that share the D-channels are configured without D-channels.

**NPA**

Numbering-plan area

**NPE**

Network processing element

**NQC**

Number of queued calls

**NSE**

Night-service extension

**NSU**

Network sharing unit

**null modem cable**

Special wiring of an RS-232-C cable such that a computer can talk to another computer (or to a printer) without a modem.

**NXX**

Public-network office code

---

**O**

**OA**

Operator assisted

**occurrence**

See [appearance](#).

**OCM**

Outbound Call Management

**offered load**

The traffic that would be generated by all the requests for service occurring within a monitored interval, usually one hour.

**ONS**

On-premises station

**OPS**

Off-premises station

**OPX**

Off-premises extension

**OQT**

Oldest queued time

**OSHA**

Occupational Safety and Health Act

**OSI**

Open Systems Interconnect

**OSS**

Operations Support System

**OSSI**

Operational Support System Interface

**OTDR**

Optical time-domain reflectometer

**othersplit**

The work state that indicates that an agent is currently active on another split's call, or in ACW for another split.

**OTL**

Originating Test Line

## OTQ

Outgoing trunk queuing

## outgoing gateway

A PBX that routes an incoming call on a trunk administered for Supplementary Services Protocol B to a trunk *not* administered for Supplementary Services Protocol B.

---

## P

### PACCON

Packet control

### packet

A group of bits (including a message element, which is the data, and a control information element (IE), which is the header) used in packet switching and transmitted as a discrete unit. In each packet, the message element and control IE are arranged in a specified format. See also [packet bus](#) and [packet switching](#).

### packet bus

A wide-bandwidth bus that transmits packets.

### packet switching

A data-transmission technique whereby user information is segmented and routed in discrete data envelopes called packets, each with its own appended control information, for routing, sequencing, and error checking. Packet switching allows a channel to be occupied only during the transmission of a packet. On completion of the transmission, the channel is made available for the transfer of other packets. See also [BX.25](#) and [packet](#).

### PAD

Packet assembly/disassembly

### paging trunk

A telecommunications channel used to access an amplifier for loudspeaker paging.

### party/extension active on call

A party is on the call if he or she is actually connected to the call (in active talk or in held state). An originator of a call is always a party on the call. Alerting parties, busy parties, and tones are not parties on the call.

### PBX

Private branch exchange

### PC

See [personal computer \(PC\)](#).

### PCM

See [pulse-code modulation \(PCM\)](#).

### PCOL

Personal central-office line

### PCOLG

Personal central-office line group

### PCS

Permanent switched calls

**PDM**

See [processor data module \(PDM\)](#).

**PDS**

Premises Distribution System

**PE**

Processing element

**PEC**

Price element code

**PEI**

Processor element interchange

**personal computer (PC)**

A personally controllable microcomputer.

**PGATE**

Packet gateway

**PGN**

Partitioned group number

**PI**

Processor interface

**PIB**

Processor interface board

**pickup group**

A group of individuals authorized to answer any call directed to an extension within the group.

**PIDB**

Product image database

**PKTINT**

Packet interface

**PL**

Private line

**PLS**

Premises Lightwave System

**PMS**

Property Management System

**PN**

Port network

**PNA**

Private network access

**POE**

Processor occupancy evaluation

**POP**

Point of presence

**port**

A data- or voice-transmission access point on a device that is used for communicating with other devices.

**port carrier**

A carrier in a multicarrier cabinet or a single-carrier cabinet containing port circuit packs, power units, and service circuits. Also called a port cabinet in a single-carrier cabinet.

**port network (PN)**

A cabinet containing a TDM bus and packet bus to which the following components are connected: port circuit packs, one or two tone-clock circuit packs, a maintenance circuit pack, service circuit packs, and (optionally) up to four expansion interface (EI) circuit packs in DEFINITY ECS. Each PN is controlled either locally or remotely by a switch processing element (SPE). See also [expansion port network \(EPN\)](#) and [processor port network \(PPN\)](#).

**port-network connectivity**

The interconnection of port networks (PNs), regardless of whether the configuration uses direct or switched connectivity.

**PPM**

1. Parts per million
2. Periodic pulse metering

**PPN**

See [processor port network \(PPN\)](#).

**PRI**

See [Primary Rate Interface \(PRI\)](#).

**primary extension**

The main extension associated with the physical voice or data terminal.

**Primary Rate Interface (PRI)**

A standard ISDN frame format that specifies the protocol used between two or more communications systems. PRI runs at 1.544 Mbps and, as used in North America, provides 23 64-kbps B-channels (voice or data) and one 64-kbps D-channel (signaling). The D-channel is the 24th channel of the interface and contains multiplexed signaling information for the other 23 channels.

**PRI endpoint (PE)**

The wideband switching capability introduces PRI endpoints on switch line-side interfaces. A PRI endpoint consists of one or more contiguous B-channels on a line-side T1 or E1 ISDN PRI facility and has an extension. Endpoint applications have call-control capabilities over PRI endpoints.

**principal**

A terminal that has its primary extension bridged on one or more other terminals.

**principal (user)**

A person to whom a telephone is assigned and who has message-center coverage.

**private network**

A network used exclusively for the telecommunications needs of a particular customer.

**private network office code (RNX)**

The first three digits of a 7-digit private network number.

**processor carrier**

See [control carrier](#).

**processor data module (PDM)**

A device that provides an RS-232C DCE interface for connecting to data terminals, applications processors (APs), and host computers, and provides a DCP interface for connection to a communications system. See also [modular processor data module \(MPDM\)](#).

**processor port network (PPN)**

A port network controlled by a switch-processing element that is directly connected to that PN's TDM bus and LAN bus. See also [port network \(PN\)](#).

**processor port network (PPN) control carrier**

A carrier containing the maintenance circuit pack, tone/clock circuit pack, and SPE circuit packs for a processor port network (PPN) and, optionally, port circuit packs.

**PROCR**

Processor

**Property Management System (PMS)**

A stand-alone computer used by lodging and health-services organizations for services such as reservations, housekeeping, and billing.

**protocol**

A set of conventions or rules governing the format and timing of message exchanges to control data movement and correction of errors.

**PSC**

Premises service consultant

**PSDN**

Packet-switch public data network

**PT**

Personal terminal

**PTC**

Positive temperature coefficient

**PTT**

Postal Telephone and Telegraph

**public network**

The network that can be openly accessed by all customers for local and long-distance calling.

**pulse-code modulation (PCM)**

An extension of pulse-amplitude modulation (PAM) in which carrier-signal pulses modulated by an analog signal, such as speech, are quantized and encoded to a digital, usually binary, format.

---

## Q

**QPPCN**

Quality Protection Plan Change Notice

**quadrant**

A group of six contiguous DS0s in fixed locations on an ISDN-PRI facility. Note that this term comes from T1 terminology (one-fourth of a T1), but there are five quadrants on an E1 ISDN-PRI facility (30B + D).

**queue**

An ordered sequence of calls waiting to be processed.

**queuing**

The process of holding calls in order of their arrival to await connection to an attendant, to an answering group, or to an idle trunk. Calls are automatically connected in first-in, first-out sequence.

---

## R

**RAM**

See [random-access memory \(RAM\)](#).

**random-access memory (RAM)**

A storage arrangement whereby information can be retrieved at a speed independent of the location of the stored information.

**RBS**

Robbed-bit signaling

**RC**

Radio controller

**RCL**

Restricted call list

**read-only memory (ROM)**

A storage arrangement primarily for information-retrieval applications.

**recall dial tone**

Tones signalling that the system has completed a function (such as holding a call) and is ready to accept dialing.

**redirection criteria**

Information administered for each voice terminal's coverage path that determines when an incoming call is redirected to coverage.

**Redirection on No Answer**

An optional feature that redirects an unanswered ringing ACD call after an administered number of rings. The call is then redirected back to the agent.

**remote home numbering-plan area code (RHNPA)**

A foreign numbering-plan area code that is treated as a home area code by the Automatic Route Selection (ARS) feature. Calls can be allowed or denied based on the area code and the dialed CO code rather than just the area code. If the call is allowed, the ARS pattern used for the call is determined by these six digits.

**Remote Operations Service Element (ROSE)**

A CCITT and ISO standard that defines a notation and services that support interactions between the various entities that make up a distributed application.

**REN**

Ringer equivalency number



**reorder tone**

A tone to signal that at least one of the facilities, such as a trunk or a digit transmitter, needed for the call was not available.

**report scheduler**

Software that is used in conjunction with the system printer to schedule the days of the week and time of day that the desired reports are to be printed.

**RFP**

Request for proposal

**RHNPA**

See [remote home numbering-plan area code \(RHNPA\)](#).

**RINL**

Remote indirect neighbor link

**RISC**

Reduced-instruction-set computer

**RLT**

Release-link trunk

**RMATS**

Remote Maintenance, Administration, and Traffic System

**RNX**

Route-number index (private network office code)

**ROM**

See [read-only memory \(ROM\)](#).

**ROSE**

See [Remote Operations Service Element \(ROSE\)](#).

**RPN**

Routing-plan number

**RS-232C**

A physical interface specified by the Electronic Industries Association (EIA). RS-232C transmits and receives asynchronous data at speeds of up to 19.2 kbps over cable distances of up to 50 feet.

**RS-449**

Recommended Standard 449

**RSC**

Regional Support Center

---

## S

**S1**

The first logical signalling channel of DCP. The channel is used to provide signaling information for DCP's I1 channel.

- S2**  
The second logical signaling channel of DCP. The channel is used to provide signaling information for DCP's I2 channel.
- SABM**  
Set Asynchronous Balance Mode
- SAC**  
Send All Calls
- SAKI**  
See [sanity and control interface \(SAKI\)](#).
- sanity and control interface (SAKI)**  
A custom VLSI microchip located on each port circuit pack. The SAKI provides address recognition, buffering, and synchronization between the angel and the five control time slots that make up the control channel. The SAKI also scans and collects status information for the angel on its port circuit pack and, when polled, transmits this information to the archangel.
- SAT**  
System access terminal
- SCC**  
  1. See [single-carrier cabinet](#).
  2. Serial communications controller
- SCD**  
Switch-control driver
- SCI**  
Switch communications interface
- SCO**  
System control office
- SCOTCH**  
Switch Conferencing for TDM Bus in Concentration Highway
- SCSI**  
See [small computer system interface \(SCSI\)](#).
- SDDN**  
Software-Defined Data Network
- SDI**  
Switched Digital International
- SDLC**  
Synchronous data-link control
- SDN**  
Software-defined network
- SFRL**  
Single-frequency return loss
- SID**  
Station-identification number
- simplex system**  
A system that has no redundant hardware.

**simulated bridged appearance**

The same as a temporary bridged appearance; allows the terminal user (usually the principal) to bridge onto a call that had been answered by another party on his or her behalf.

**single-carrier cabinet**

A combined cabinet and carrier unit that contains one carrier. See also [Multicarrier cabinet](#).

**single-line voice terminal**

A voice terminal served by a single-line tip and ring circuit (models 500, 2500, 7101A, 7103A).

**SIT**

Special-information tones

**small computer system interface (SCSI)**

An ANSI bus standard that provides a high-level command interface between host computers and peripheral devices.

**SMDR**

Station Message Detail Recording

**SN**

Switch Node

**SNA**

Systems Network Architecture

**SNC**

Switch Node Clock

**SNI**

Switch Node Interface

**SNMP**

Simple Network Management Protocol

**software**

A set of computer programs that perform one or more tasks.

**SPE**

Switch Processing Element

**SPID**

Service Profile Identifier

**split**

See [ACD work mode](#).

**split condition**

A condition whereby a caller is temporarily separated from a connection with an attendant. A split condition automatically occurs when the attendant, active on a call, presses the start button.

**split number**

The split's identity to the switch and BCMS.

**split report**

A report that provides historical traffic information for internally measured splits.

**split (agent) status report**

A report that provides real-time status and measurement data for internally measured agents and the split to which they are assigned.

**SSI**

Standard serial interface

**SSM**

Single-site management

**SSV**

Station service

**ST3**

Stratum 3 clock board

**staffed**

Indicates that an agent position is logged in. A staffed agent functions in one of four work modes: Auto-In, Manual-In, ACW, or AUX-Work.

**STARLAN**

Star-Based Local Area Network

**Station Message Detail Recording (SMDR)**

An obsolete term now called CDR — a switch feature that uses software and hardware to record call data. See [Call Detail Recording \(CDR\)](#).

**standard serial interface (SSI)**

A communications protocol developed for use with 500-type business communications terminals (BCTs) and 400-series printers.

**status lamp**

A green light that shows the status of a call appearance or a feature button by the state of the light (lit, flashing, fluttering, broken flutter, or unlit).

**stroke counts**

A method used by ACD agents to record up to nine customer-defined events per call when CMS is active.

**SVN**

Security-violation notification

**switch**

Any kind of telephone switching system. See also [communications system](#).

**switchhook**

The buttons located under the receiver on a voice terminal.

**switch-node (SN) carrier**

A carrier containing a single switch node, power units, and, optionally, one or two DS1 converter circuit packs. An SN carrier is located in a center-stage switch.

**switch-node (SN) clock**

The circuit pack in an SN carrier that provides clock and maintenance alarm functions and environmental monitors.

**switch-node interface (SNI)**

The basic building block of a switch node. An SNI circuit pack controls the routing of circuit, packet, and control messages.

**switch-node link (SNL)**

The hardware that provides a bridge between two or more switch nodes. The SNL consists of the two SNI circuit packs residing on the switch nodes and the hardware connecting the SNIs. This hardware can include lightwave transceivers that convert the SNI's electrical signals to light signals, the copper wire that connects the SNIs to the lightwave transceivers, a full-duplex fiber-optic cable, DS1 converter circuit cards and DS1 facilities if a company does not have rights to lay cable, and appropriate connectors.

**switch-processing element (SPE)**

A complex of circuit packs (processor, memory, disk controller, and bus-interface cards) mounted in a PPN control carrier. The SPE serves as the control element for that PPN and, optionally, for one or more EPNs.

**SXS**

Step-by-step

**synchronous data transmission**

A method of sending data in which discrete signal elements are sent at a fixed and continuous rate and specified times. See also [association](#).

**SYSAM**

System Access and Administration

**system administrator**

The person who maintains overall customer responsibility for system administration. Generally, all administration functions are performed from the Management Terminal. The switch requires a special login, referred to as the system administrator login, to gain access to system-administration capabilities.

**system printer**

An optional printer that may be used to print scheduled reports via the report scheduler.

**system report**

A report that provides historical traffic information for internally measured splits.

**system-status report**

A report that provides real-time status information for internally measured splits.

**system manager**

A person responsible for specifying and administering features and services for a system.

**system reload**

A process that allows stored data to be written from a tape into the system memory (normally after a power outage).

---

**T**

**T1**

A digital transmission standard that in North America carries traffic at the DS1 rate of 1.544 Mbps. A T1 facility is divided into 24 channels (DS0s) of 64 kbps. These 24 channels, with an overall digital rate of 1.536 Mbps, and an 8-kbps framing and synchronization channel make up the 1.544-Mbps transmission. When a D-channel is present, it occupies channel 24. T1 facilities are also used in Japan and some Middle-Eastern countries.

**TAAS**

Trunk Answer from Any Station

**TABS**

Telemetry asynchronous block serial

**TAC**

Trunk-access code

**tandem switch**

A switch within an electronic tandem network (ETN) that provides the logic to determine the best route for a network call, possibly modifies the digits outpulsed, and allows or denies certain calls to certain users.

**tandem through**

The switched connection of an incoming trunk to an outgoing trunk without human intervention.

**tandem tie-trunk network (TTTN)**

A private network that interconnects several customer switching systems.

**TC**

Technical consultant

**TCM**

Traveling class mark

**TDM**

See [time-division multiplexing \(TDM\)](#).

**TDR**

Time-of-day routing

**TEG**

Terminating extension group

**terminal**

A device that sends and receives data within a system. See also [administration terminal](#).

**tie trunk**

A telecommunications channel that directly connects two private switching systems.

**time-division multiplex (TDM) bus**

A bus that is time-shared regularly by preallocating short time slots to each transmitter. In a PBX, all port circuits are connected to the TDM bus, permitting any port to send a signal to any other port.

**time-division multiplexing (TDM)**

Multiplexing that divides a transmission channel into successive time slots. See also [multiplexing](#).

**time interval**

The period of time, either one hour or one-half hour, that BCMS measurements are collected for a reports.

**time slice**

See [time interval](#).

**time slot**

64 kbps of digital information structured as eight bits every 125 microseconds. In the switch, a time slot refers to either a DS0 on a T1 or E1 facility or a 64-kbps unit on the TDM bus or fiber connection between port networks.

**time slot sequence integrity**

The situation whereby the N octets of a wideband call that are transmitted in one T1 or E1 frame arrive at the output in the same order that they were introduced.

**to control**

An application can invoke *Third Party Call Control* capabilities using either an adjunct-control or domain-control association.

**to monitor**

An application can receive *event reports* on an active-notification, adjunct-control, or domain-control association.

**TOD**

Time of day

**tone ringer**

A device with a speaker, used in electronic voice terminals to alert the user.

**TOP**

Task-oriented protocol

**trunk**

A dedicated telecommunications channel between two communications systems or COs.

**trunk allocation**

The manner in which trunks are selected to form wideband channels.

**trunk-data module**

A device that connects off-premises private-line trunk facilities and DEFINITY ECS. The trunk-data module converts between the RS-232C and the DCP, and can connect to DDD modems as the DCP member of a modem pool.

**trunk group**

Telecommunications channels assigned as a group for certain functions that can be used interchangeably between two communications systems or COs.

**TSC**

Technical Service Center

**TTI**

Terminal translation initialization

**TTR**

Touch-tone receiver

**TTT**

Terminating trunk transmission

**TTTN**

See [tandem tie-trunk network \(TTTN\)](#).

**TTY**

Teletypewriter

---

## U

### UAP

Usage-allocation plan

### UART

Universal asynchronous transmitter

### UCD

Uniform call distribution

### UCL

Unrestricted call list

### UDP

See [Uniform Dial Plan \(UDP\)](#).

### UL

Underwriter Laboratories

### UM

User manager

### Uniform Dial Plan (UDP)

A feature that allows a unique 4- or 5-digit number assignment for each terminal in a multiswitch configuration such as a DCS or main-satellite-tributary system.

### UNMA

Unified Network Management Architecture

### UNP

Uniform numbering plan

### UPS

Uninterruptible power supply

### USOP

User service-order profile

### UUCP

UNIX-to-UNIX Communications Protocol

### UUI

User-to-user information

---

## V

### VAR

Value-added reseller

### VDN

See [vector directory number \(VDN\)](#).



**vector directory number (VDN)**

An extension that provides access to the Vectoring feature on the switch. Vectoring allows a customer to specify the treatment of incoming calls based on the dialed number.

**vector-controlled split**

A hunt group or ACD split administered with the vector field enabled. Access to such a split is possible only by dialing a VDN extension.

**VIS**

Voice Information System

**VLSI**

Very-large-scale integration

**VM**

Voltmeter

**VNI**

Virtual nodepoint identifier

**voice terminal**

A single-line or multiappearance telephone.

---

## W

**WATS**

See [Wide Area Telecommunications Service \(WATS\)](#).

**WCC**

World-Class Core

**WCR**

World-Class Routing

**WCTD**

World-Class Tone Detection

**WFB**

Wireless fixed base

**Wide Area Telecommunications Service (WATS)**

A service in the United States that allows calls to certain areas for a flat-rate charge based on expected usage.

**wideband**

A circuit-switched call at a data rate greater than 64 kbps. A circuit-switched call on a single T1 or E1 facility with a bandwidth between 128 and 1536 (T1) or 1984 (E1) kbps in multiples of 64 kbps. H0, H11, H12, and N x DS0 calls are wideband.

**wideband access endpoint**

Access endpoints, extended with wideband switching to include wideband access endpoints. A wideband access endpoint consists of one or more contiguous DS0s on a line-side T1 or E1 facility and has an extension. The Administered Connections feature provides call control for calls originating from wideband access endpoints.

**wink-start tie trunk**

A trunk with which, after making a connection with a distant switching system for an outgoing call, the system waits for a momentary signal (wink) before sending the digits of the called number. Similarly, on an incoming call, the system sends the wink signal when ready to receive digits.

**work mode**

One of four states (Auto-In, Manual-In, ACW, AUX-Work) that an ACD agent can be in. Upon logging in, an agent enters AUX-Work mode. To become available to receive ACD calls, the agent enters Auto-In or Manual-In mode. To do work associated with a completed ACD call, an agent enters ACW mode.

**work state**

An ACD agent may be a member of up to three different splits. Each ACD agent continuously exhibits a work state for every split of which it is a member. Valid work states are Avail, Unstaffed, AUX-Work, ACW, ACD (answering an ACD call), ExtIn, ExtOut, and OtherSpl. An agent's work state for a particular split may change for a variety of reasons (example: when a call is answered or abandoned, or the agent changes work modes). The BCMS feature monitors work states and uses this information to provide BCMS reports.

**write operation**

The process of putting information onto a storage medium, such as a hard disk.

**WSA**

Waiting session accept

**WSS**

Wireless Subscriber System

---

**Z**

**ZCS**

Zero Code Suppression

# Index

---

## Numerics

- 1, [5-210](#), [5-298](#)
- 1-burst ringing, [4-468](#), [12-43](#)
- 1-button transfers, [4-295](#)
- 2-burst ringing, [12-43](#)
- 3-burst ringing, [4-483](#), [4-520](#), [9-13](#), [12-43](#)
- 7-digit barrier codes, [4-511](#)
- 7-layer Open Systems Interconnect (OSI) Reference Model, [4-382](#)
- 10-MET voice terminals, [6-44](#), [6-41](#)
- 20-MET voice terminals, [6-41](#), [6-45](#)
- 26A enhanced selector consoles, [5-47](#)
- 30-MET voice terminals, [6-41](#), [6-46](#)
- 32-character display stations, [4-39](#)
- 40-character display stations, [4-20](#)
- 302A attendant consoles, [5-45](#)
- 302B attendant consoles, [5-45](#)
- 302C attendant consoles, [5-46](#)
- 500 voice terminals, [6-47](#), [6-49](#)
- 510D personal terminals, [6-55](#), [6-59](#)
- 513 system administration terminals (SAT), [2-2](#)
- 515 business communications terminals, [6-55](#), [6-59](#)
- 603-type CALLMASTER, *see* CALLMASTER voice terminals
- 610 system administration terminals (SAT), [2-2](#)
- 615 system administration terminals (SAT), [2-2](#)
- 715 system administration terminals (SAT), [2-2](#)
- 911 emergency calls, [4-66](#)
- 365, [4-290](#)
- 2500 voice terminals, [6-47](#), [6-49](#)
- 2554 voice terminals, [6-50](#)
- 4410 system administration terminals (SAT), [2-2](#)
- 4425 system administration terminals (SAT), [2-2](#)
- 6402 DCP 2-wire single line voice terminals, [6-60](#), [6-69](#)
- 6402D DCP 2-wire single line display voice terminals, [6-60](#), [6-70](#)
- 6402D DCP 2-wire single line voice terminals, [6-60](#)
- 6408 DCP 2-wire multiline voice terminals, [6-60](#)
- 6408+ DCP 2-wire multiline voice terminals, [6-60](#)
- 6408D DCP 2-wire multiline voice terminals, [6-60](#), [6-71](#)
- 6416D+ DCP 2-wire multiline voice terminals, [6-60](#)
- 6424D+ DCP 2-wire multiline voice terminals, [6-60](#)
- 7101A voice terminals, [6-47](#), [6-50](#)
- 7102A voice terminals, [6-47](#), [6-51](#)
- 7103A fixed feature voice terminals, [4-8](#), [5-14](#), [6-47](#), [6-52](#)
- 7103A group number lists, [4-8](#)
- 7104A voice terminals, [6-47](#), [6-53](#)
- 7302H (5-button) MERLIN voice terminals, [6-72](#)
- 7303H (10-button) MERLIN voice terminals, [6-72](#)
- 7303S voice terminals, [6-73](#), [6-77](#)
- 7305H (34-button) MERLIN voice terminals, [6-72](#)
- 7305S voice terminals, [6-73](#), [6-78](#)
- 7309H voice terminals, [6-73](#), [6-79](#)
- 7313H (BIS-10) voice terminals, [6-80](#), [6-85](#)
- 7314H (BIS-22) voice terminals, [6-80](#), [6-86](#)
- 7315H (BIS-22D) voice terminals, [4-39](#), [6-80](#), [6-87](#)
- 7316H (BIS-34) voice terminals, [6-80](#), [6-88](#)

7317H (BIS-34D) voice terminals, [4-39](#), [6-80](#), [6-89](#)  
7400A data modules, [6-227](#)  
7400B data modules, [6-91](#)  
7400B+ data modules, [6-227](#)  
7400C high speed links (HSL), [6-228](#)  
7401+ voice terminals, [6-90](#)  
7401D voice terminals, [6-90](#), [6-97](#)  
7403D voice terminals, [6-90](#)  
7404D voice terminals, [6-90](#), [6-98](#)  
7405D ISDN-BRI voice terminals, [6-99](#), [6-106](#), [6-130](#), [6-223](#)  
7406+ voice terminals, [6-111](#)  
7406D ISDN-BRI voice terminals, [6-111](#), [6-118](#), [6-130](#)  
7406D+ ISDN-BRI voice terminals, [6-119](#)  
7407+ voice terminals, [6-111](#)  
7407D ISDN-BRI voice terminals, [6-111](#), [6-130](#)  
7410+ voice terminals, [6-90](#)  
7410D voice terminals, [6-90](#)  
7434D voice terminals, [6-121](#)  
7444D voice terminals, [6-121](#)  
7500 data modules, [4-385](#), [6-226](#), [6-228](#), [6-252](#)  
8110 voice terminals, [6-47](#)  
8400B data modules, [6-91](#)  
8403B voice terminals, [6-172](#), [6-178](#)  
8405+ voice terminals, [6-172](#), [6-179](#)  
8405B voice terminals, [6-172](#), [6-179](#)  
8405D voice terminals, [6-180](#), [6-187](#)  
8405D+ voice terminals, [6-180](#), [6-187](#)  
8410B voice terminals, [6-172](#), [6-179](#)  
8410D voice terminals, [6-180](#), [6-187](#)  
8411B voice terminals, [6-189](#)  
8411D voice terminals, [6-189](#)  
8434D voice terminals, [6-180](#), [6-188](#)  
8503D ISDN-BRI voice terminals, [6-130](#), [6-138](#)  
8510T ISDN-BRI voice terminals, [6-130](#), [6-139](#)  
8520T ISDN-BRI voice terminals, [6-130](#), [6-140](#)

---

## A

AAR and ARS Digit Analysis Table form, [8-55](#) to [8-62](#)  
    administration commands, [8-55](#)  
AAR and ARS Digit Conversion Table form, [8-63](#) to [8-64](#)  
    administration commands, [8-63](#)  
AAR and ARS features, [8-3](#) to [8-19](#)  
    AAR analysis tables  
        dialed string entries, [8-57](#)  
    AAR dialing, [8-11](#)  
    ARS analysis tables  
        call types, [8-58](#)  
        digit analysis default translations, [8-61](#)  
    ARS dialing, [8-12](#)  
    authorization codes, [4-95](#)  
    considerations, [8-17](#)  
    detailed description, [8-6](#)  
    dialing, [8-8](#)  
    digit analysis, [8-8](#)  
    digit conversion, [8-9](#)  
    forms, [5-263](#), [8-4](#), [8-55](#), [8-63](#), [8-67](#)

- AAR and ARS features, (cont)
  - interactions, [8-17](#)
    - Abbreviated Dialing (AD), [8-17](#)
    - Administered Connections (AC), [4-18](#)
    - Alternate Facility Restriction Levels (AFRL), [8-32](#)
    - Attendant Control of Trunk Group Access, [4-64](#), [8-17](#)
    - Authorization Codes, [4-96](#)
    - Call by Call (CBC) Service Selection, [7-47](#)
    - Call Detail Recording (CDR), [4-215](#), [8-18](#)
    - Call Vectoring, [9-67](#)
    - CallVisor ASAI, [4-257](#)
    - Centralized Attendant Service (CAS), [8-17](#), [12-8](#)
    - Class of Restriction (COR), [4-274](#), [4-276](#)
    - Facility Restriction Levels (FRL) and Traveling Class Marks (TCM), [8-28](#)
    - forced entry of account codes (FEAC), [8-18](#)
    - ISDN-BRI, [8-18](#)
    - Look Ahead (LAI) Interflow, [9-100](#)
    - miscellaneous trunk restrictions, [8-18](#)
    - personal central office lines (PCOL), [8-18](#)
    - QSIG Call Forwarding (Diversion), [12-100](#)
    - Recorded Telephone Dictation Access, [4-508](#)
    - Restriction—Controlled, [8-18](#)
    - Ringback Queuing, [4-521](#), [8-18](#)
    - Tenant Partitioning, [4-575](#)
    - Time of Day (TOD) Routing, [8-52](#)
    - toll restrictions, [8-19](#)
    - Uniform Dial Plan (UDP), [12-108](#)
    - Voice Terminal Display, [8-19](#)
  - interdigit timeouts, [8-8](#)
  - private networks, [8-3](#)
  - public networks, [8-3](#)
  - remote home numbering plan area (RHNPA) entries, [8-55](#)
  - route patterns, [8-10](#)
  - trunking facilities, [8-16](#)
- AAR and ARS Overlap Sending feature, [8-20](#)
  - interactions
    - ISDN feature, [7-40](#)
- AAR and ARS Partitioning feature, [8-21](#) to [8-23](#)
  - interactions
    - Bridged Call Appearance, [8-22](#)
    - Call Detail Recording (CDR), [8-22](#)
    - call forwarding—all calls, [8-22](#)
    - Class of Restriction (COR), [4-274](#)
    - Distributed Communications System (DCS), [8-22](#)
    - Remote Access, [8-22](#)
    - straightforward outward completion and through dialing, [8-23](#)
    - Time of Day (TOD) Routing, [8-23](#)
    - Uniform Dial Plan (UDP), [8-23](#)
  - routing patterns, [8-21](#)
  - user situations, [8-22](#)
- AAR and ARS Toll Table form
  - administration commands, [8-75](#)
- AAR dialing, [8-11](#)

- Abandoned Call Search feature, [9-3](#) to [9-4](#)
  - interactions
    - Call Management System (CMS), [9-4](#)
    - Redirection on No Answer (RONA), [9-121](#)
- Abbreviated Dialing (AD) feature, [4-1](#) to [4-12](#)
  - Abbreviated Dialing buttons, [4-403](#), [4-453](#)
  - AbrvDial (char) buttons, [6-14](#)
  - AbrvDial Program buttons, [6-14](#)
  - AD buttons, [4-1](#), [4-7](#), [4-8](#), [6-14](#)
  - considerations, [4-11](#)
  - designated users, [4-9](#)
  - dial codes, [5-3](#), [5-6](#), [5-10](#), [5-13](#), [5-16](#)
  - end user operations, [4-8](#)
  - enhanced number lists, [4-4](#), [4-5](#)
  - forms, [4-2](#), [5-14](#)
  - group number lists, [4-3](#), [4-5](#), [4-9](#)
  - interactions
    - AAR and ARS, [8-17](#)
    - Administered Connections (AC), [4-18](#)
    - Administration without Hardware (AWOH), [4-41](#)
    - Agent Call Handling, [9-19](#)
    - Attendant Console, [4-12](#)
    - AUDIX, [4-12](#)
    - Bridged Call Appearance, [4-12](#), [4-116](#)
    - Call Detail Recording (CDR), [4-213](#)
    - Call Park, [4-234](#)
    - Call Pickup, [4-238](#)
    - CallVisor ASAI, [4-256](#)
    - Centralized Attendant Service (CAS), [12-7](#)
    - Class of Restriction (COR), [4-276](#)
    - Code Calling Access, [4-281](#)
    - Data Call Setup, [4-296](#)
    - Expert Agent Selection (EAS), [9-78](#)
    - Extended Trunk Access (ETA), [12-68](#)
    - Hotline Service, [4-12](#)
    - Individual Attendant Access, [4-377](#)
    - Last Number Dialed, [4-12](#), [4-403](#)
    - MF Signaling, [4-442](#)
    - Priority Calling, [4-484](#)
    - Reason Codes, [9-115](#)
    - Remote Access, [4-12](#)
    - Time of Day (TOD) Routing, [8-52](#)
- list access options, [4-7](#)
- list entries, [4-4](#)
- list types, [4-3](#)
- personal number lists, [4-3](#), [4-4](#), [4-8](#)
- security alerts, [4-12](#)
- special characters, [4-5](#), [4-6](#)
- system number lists, [4-4](#), [4-5](#)
- Abbreviated Dialing List forms
  - 7103A Button List form, [5-14](#) to [5-16](#)
  - Enhanced List form, [5-2](#) to [5-4](#)
  - Group List form, [5-5](#) to [5-7](#)
  - Personal List form, [5-8](#) to [5-10](#)
  - System List form, [5-11](#) to [5-13](#)
- Abbreviated Dialing List—System List form
  - administration commands, [5-61](#), [7-161](#)

- abbreviated ringing, [4-526](#)
- abstract syntax notation 1 (ASN-1), [12-79](#)
- ACA Measurements Report, [4-105](#)
- Access Endpoint form, [7-72](#) to [7-75](#), [7-122](#)
- access endpoints, [4-15](#)
- Access Trunk Group form, [7-122](#), [7-150](#) to [7-155](#)
- Acct buttons, [6-15](#)
- ACCUNET, [7-43](#), [7-120](#), [7-198](#), [7-219](#)
- acoustic coupled modems, [4-449](#)
- action commands, [B-1](#)
- add commands, [B-2](#)
- add data-module command, [1-8](#)
- Add/Remove Skills feature, [9-5](#)
  - interactions
    - Auto Available Split (AAS), [9-6](#)
    - Basic Call Management System (BCMS), [9-5](#), [9-6](#)
    - Call Management System (CMS), [9-5](#)
    - CallVisor ASAI, [4-256](#)
    - Expert Agent Selection (EAS), [9-5](#), [9-78](#)
    - Expert Agent Selection-preference handling distribution (EAS-PHD), [9-6](#)
    - Service Observing, [4-551](#)
    - VuStats, [9-5](#), [9-6](#)
  - forms, [9-5](#)
- additional network features (ANF), [12-79](#)
- adjuncts
  - Audichron, [4-507](#)
  - defined adjunct names, see User Defined Adjunct Names form
  - Inbound Call Management (ICM) applications, [9-83](#)
  - processors, [9-84](#)
  - speech processing, [9-85](#)
  - terminal parameters, [6-13](#)
- Admin buttons, [4-578](#), [6-15](#)
- Administered Connections (AC) feature, [4-13](#) to [4-19](#)
  - AC Alarm buttons, [6-15](#)
  - access endpoints, [4-15](#)
  - applications, [4-15](#)
  - autorestorations, [4-17](#)
  - dropping administered connections, [4-17](#)
  - errors, [4-16](#)
  - establishing administered connections, [4-16](#)
  - failures, [4-16](#), [4-17](#)
  - fast retries, [4-17](#)
  - forms, [4-13](#), [5-17](#)
  - interactions
    - AAR and ARS, [4-18](#)
    - Abbreviated Dialing (AD), [4-18](#)
    - Administration without Hardware (AWOH), [4-44](#), [4-47](#)
    - Busy Verification of Terminals and Trunks (Verify), [4-18](#)
    - Call Detail Recording (CDR), [4-18](#)
    - Call Forwarding, [4-18](#)
    - Class of Restriction (COR), [4-18](#)
    - Class of Service (COS), [4-18](#)
    - Data Call Setup, [4-18](#)
    - Data Hotline, [4-18](#)
    - D-channel backup, [4-19](#)
    - Digital Multiplexed Interface (DMI), [4-18](#)
    - Facility and Nonfacility Associated Signaling (FAS and NFAS), [4-19](#)
    - Facility Test Calls, [4-19](#)

- Administered Connections (AC) feature, interactions, (cont)
  - Generalized Route Selection (GRS), [4-18](#)
  - Hunt Groups, [4-19](#)
  - Modem Pooling, [4-19](#)
  - Multimedia Call Handling (MMCH), [11-65](#), [11-86](#)
  - set time command, [4-19](#)
  - system measurements, [4-19](#)
  - terminal dialing, [4-19](#)
  - Terminal Self Administration (TSA), [4-580](#)
  - trunk groups, [4-19](#)
  - Wideband Switching, [7-68](#)
- SDDN ISDN-PRI trunk groups, [4-13](#)
- Administered Connections (AC) form, [5-17](#) to [5-20](#)
- Administrable Language Displays feature, [4-20](#) to [4-39](#)
  - call appearance designations, [4-22](#)
  - considerations, [4-39](#)
  - feature displays, [4-20](#)
  - interactions
    - Automatic Circuit Assurance (ACA), [4-106](#)
- administrable ringing patterns, [4-480](#)
- administration
  - commands, [B-1](#)
  - sequence, [1-5](#)
- Administration without Hardware (AWOH) feature, [4-40](#) to [4-48](#)
  - association and disassociation interactions, [4-45](#)
  - attendant interactions, [4-43](#)
  - AWOH stations, [4-40](#)
  - data module interactions, [4-47](#)
  - data terminal interactions, [4-44](#)
  - interactions
    - Abbreviated Dialing (AD), [4-41](#)
    - Administered Connections (AC), [4-44](#), [4-47](#)
    - attendant groups, [4-43](#)
    - Attendant Priority Queue, [4-45](#)
    - Attendant Release Loop Operation, [4-45](#)
    - attendant return calls, [4-47](#)
    - Attendant Serial Calling, [4-47](#)
    - Automatic Call Distribution (ACD), [4-41](#)
    - Automatic Callback (ACB), [4-41](#), [4-45](#)
    - Bridged Call Appearance, [4-41](#), [4-45](#)
    - Busy Verification of Terminals and Trunks (Verify), [4-41](#)
    - Call Coverage, [4-42](#), [4-45](#), [4-162](#)
    - call coverage answer groups, [4-45](#)
    - Call Forwarding, [4-42](#), [4-46](#)
    - Call Park, [4-42](#), [4-46](#)
    - Call Pickup, [4-46](#), [4-238](#)
    - Call Waiting Termination, [4-42](#)
    - Conference, [4-42](#)
    - Customer Provided Equipment (CPE) Alarm, [4-42](#)
    - Data buttons, [4-42](#)
    - Data Call Setup, [4-44](#)
    - data terminal dialing, [4-47](#)
    - displays, [4-42](#)
    - Emergency Access to Attendant, [4-44](#)
    - Expert Agent Selection (EAS), [9-78](#)
    - Extended User Administration of Redirected Calls, [4-338](#)



Administration without Hardware (AWOH) feature, interactions, (cont)

- Facility Busy Indication, [4-42](#)
- Hold, [4-46](#)
- Hunt Groups, [4-44](#), [4-46](#), [4-48](#)
- incoming destinations, [4-42](#), [4-44](#)
- Intercom—Automatic, [4-46](#)
- Intercom—Dial, [4-46](#)
- interposition calling (attendant to attendant), [4-44](#)
- Leave Word Calling (LWC), [4-43](#)
- Manual Message Waiting, [4-43](#)
- Manual Signaling, [4-43](#)
- message lights, [4-46](#)
- Multimedia Call Handling (MMCH), [11-65](#), [11-86](#)
- night station service, [4-44](#), [4-45](#)
- personal central office lines (PCOL), [4-43](#)
- Priority Calling, [4-43](#)
- Ringin—Abbreviated and Delayed, [4-529](#)
- Send All Calls (SAC), [4-43](#), [4-46](#)
- Station Hunting, [4-43](#), [4-559](#)
- station to station calls, [4-43](#), [4-46](#)
- terminal to data module calls, [4-44](#), [4-48](#)
- Terminating Extension Group (TEG), [4-46](#)
- Transfer, [4-43](#), [4-47](#), [4-48](#)
- trunk group night service, [4-47](#)
- voice terminal dialing, [4-47](#)
- world class attendants, [4-44](#)

- ISDN—BRI terminals, [4-43](#)
- phantom stations, [4-41](#)
- station disassociations and associations, [4-40](#)
- voice terminal interactions, [4-41](#)
- world class attendant interactions, [4-47](#)

advanced private line termination (APLT), [7-120](#), [7-156](#)

after call work (ACW)

- buttons, [6-15](#), [9-33](#)
- modes, [9-12](#)
- states, [9-5](#)

Agent Call Handling feature, [9-7](#) to [9-21](#)

- after call work (ACW) modes, [9-12](#)
- agent sizing, [9-15](#)
- agents assigned to hunt group and ACD calls, [9-19](#)
- agents with automatic answer, [9-18](#)
- answering options, [9-10](#)
- Assist buttons/feature access codes (FAC), [9-13](#)
- Audio Difficulty buttons, [9-13](#)
- auto-in modes, [9-11](#)
- automatic answer, [9-10](#)
- Automatic Call Distribution (ACD) work modes, [9-10](#)
- auxiliary (AUX) work modes, [9-9](#), [9-11](#)
- button assignments, [9-17](#)
- CALLMASTER voice terminals, [9-10](#), [9-14](#), [9-18](#)
- cancelling timed after call work (ACW), [9-12](#)
- considerations, [9-17](#)
- detailed description, [9-9](#)
- expanded technical information, [9-15](#)
- forms, [9-7](#)
- headsets, [9-18](#)
- home agents, [9-12](#)

Agent Call Handling feature, (cont)

- hunt group calls, [9-19](#)
- interactions
  - Abbreviated Dialing (AD), [9-19](#)
  - Auto Available Split (AAS), [9-19](#)
  - Bridged Call Appearance, [9-19](#)
  - Call Coverage, [4-162](#), [9-19](#)
  - Call Forwarding, [9-19](#)
  - Call Pickup, [9-19](#)
  - call work codes (CWC), [9-14](#), [9-19](#)
  - CallVisor ASAI, [9-7](#), [9-20](#)
  - CenterVu CMS, [9-17](#), [9-20](#)
  - Conference—Attendant, [9-20](#)
  - Conference—Terminal, [9-20](#)
  - Expert Agent Selection (EAS), [9-20](#)
  - Multiple Call Handling (MCH), [9-20](#)
  - Transfer, [9-20](#)
  - VDN of Origin Announcement (VOA), [9-149](#)
- vector directory number (VDN) override, [9-21](#)
- Voice Response Integration (VRI), [9-21](#)

- logins/logouts, [9-9](#)
- manual answer, [9-10](#)
- manual-in modes, [9-11](#)
- most idle agent (MIA) queues, [9-11](#)
- Release buttons, [9-17](#)
- splits, [9-11](#), [9-17](#), [9-18](#)
- stroke counts, [9-13](#), [9-14](#)
- supervisory assistance, [9-13](#)
- timed after call work (ACW), [9-12](#), [9-17](#)

Agent LoginID form, [9-193](#) to [9-196](#)

agents

- see also* most idle agents (MIA)
- ACD split agents, [4-369](#)
- ACD work modes, [9-10](#), [9-121](#)
- answering options, [9-10](#)
- automatic message waiting lights, [9-35](#)
- capacities, *see* sizing
- considerations
  - Automatic Answer, [9-18](#)
  - Automatic Call Distribution (ACD), [9-19](#)
- data screen delivery applications, [9-84](#)
- greatest need routing, [9-75](#)
- home agents
  - Redirection on No Answer (RONA), [9-118](#), [9-126](#)
  - timed after call work (ACW), [9-12](#)
  - VDN of Origin Announcement (VOA), [9-150](#)
- hunt group calls, [9-19](#)
- logins, *see under* logins
- logouts, *see under* logouts
- move agent requests, [9-24](#), [9-108](#)
- multiple skills, [9-115](#)
- origination and termination restrictions, [9-35](#)
- pacing, [9-12](#), [9-17](#)
- personal calls, [9-78](#)
- sizing, [9-15](#), [9-34](#)

- agents, (cont)
  - skill level routing, [9-75](#)
  - supervisory assistance, [9-13](#)
  - Voice Response Integration (VRI), [9-155](#)
  - VuStats data, [9-173](#)
- alarms
  - origination, [2-4](#)
  - security violations, [4-531](#)
- Alert Agent buttons, [6-15](#)
- algorithms
  - call pickup distribution, [4-237](#)
  - look ahead, [8-39](#)
  - MIA, [9-28](#)
  - most idle agents (MIA), [9-75](#)
  - trunk groups, [7-63](#)
- Alias Station form, [5-21](#) to [5-22](#)
- alias stations, [6-132](#), [6-135](#), [6-136](#), [6-141](#)
- Alphanumeric Dialing feature, [4-49](#)
- Alphanumeric Dialing Table form, [5-23](#) to [5-25](#)
- Alternate Facility Restriction Levels (AFRL) feature, [8-29](#) to [8-32](#)
  - AFRL mapping, [8-31](#)
  - ALT-FRL buttons, [6-15](#), [8-29](#)
  - attendant perspective, [8-29](#)
  - authorization codes, [8-31](#)
  - caution, [8-29](#)
  - considerations, [8-30](#)
  - forms, [8-29](#)
  - FRL entities, [8-30](#)
  - guidelines, [8-31](#)
  - interactions
    - AAR and ARS, [8-32](#)
    - Facility Restriction Levels (FRL) and Traveling Class Marks (TCM), [8-32](#)
    - QSIG Call Forwarding (Diversion), [12-99](#)
  - terminal user perspective, [8-30](#)
  - toll fraud prevention, [8-29](#)
  - trunk originator case, [8-30](#)
- Alternate Operations Support System Alarm (OSSA) Number feature, [4-51](#)
- alternate voice data (AVD) signaling, [7-16](#)
- American Society of Composers, Artists, and Producers (ASCAP), [4-455](#), [4-568](#)
- AMW buttons, [10-8](#)
- analog tie trunks, [7-119](#)
- announcement data modules, [6-233](#)
- Announcement Ports, [10-34](#)
- Announcement Type, [10-33](#)
- announcements
  - see also* Recorded Announcement and VDN of Origin Announcement (VOA)
  - auxiliary boards, [10-33](#)
  - CallVisor ASAI, [4-256](#)
  - default extension, [10-34](#)
  - delay announcements, [9-126](#)
  - first, [9-29](#)
  - forced first, [9-30](#)
  - integrated extension, [10-34](#)
  - rules, [9-32](#)
  - second, [9-31](#)
  - splits, [9-29](#)
  - Voice Response Integration (VRI), [9-158](#)
- Announcements/Audio Sources form, [5-26](#) to [5-34](#)

- Answer Detection feature, [4-52](#) to [4-53](#)
  - interactions
    - Call Detail Recording (CDR), [4-53](#), [4-213](#)
    - Call Forwarding, [4-228](#)
    - Call Prompting, [4-53](#)
    - CallVisor ASAI, [4-53](#), [4-257](#)
- answer supervision
  - Answer Detection, [4-52](#)
  - Hunt Groups, [4-371](#)
  - tests, [4-600](#)
  - timer detection, [4-52](#)
  - trunk group timers, [4-76](#)
  - Voice Response Integration (VRI), [9-155](#)
- answering machine messages, [4-97](#)
- APLT Trunk Group form, [7-122](#), [7-156](#) to [7-158](#)
- application programming interfaces (API), [4-250](#)
- AQC buttons, [6-16](#)
- AQT buttons, [6-16](#)
- AR buttons, [6-14](#)
- ARS dialing, [8-12](#)
- ARS Toll Table form, [8-75](#)
- ASCII mode, [10-32](#)
- asvsn-halt buttons, [6-15](#)
- asynchronous data modules (ADM), [4-385](#), [6-229](#)
- asynchronous data units (ADU), [4-290](#)
- AT&T Intelligent Call Processing (ICP) service, [9-61](#)
- AT&T MultiQuest 900 Vari-A-Bill Service, [4-345](#)
- AT&T Switched Network Protocols, [7-28](#), [7-85](#)
- AT&T Switched Network Services, [7-28](#), [7-101](#)
- atd-qcall feature buttons, [4-55](#)
- ATMS Thresholds form, [7-143](#), [7-177](#)
- ATMS Trunk Test Schedule form, [7-76](#) to [7-78](#), [7-122](#)
- attendant
  - access codes, [4-310](#)
  - barge in, [10-9](#)
  - call appearance buttons, [4-76](#)
  - call categories, [4-85](#)
  - interactions
    - Administration without Hardware (AWOH), [4-43](#)
    - Call Pickup, [4-238](#)
    - CallVisor ASAI, [4-257](#)
    - Redirection on No Answer (RONA), [9-123](#)
    - Terminal Translation Initialization (TTI), [4-585](#)
    - Time of Day (TOD) Routing, [8-52](#)
  - return calls, [4-371](#)
- Attendant Auto Manual Splitting feature, [4-54](#)
  - interactions
    - Centralized Attendant Service (CAS), [12-8](#)
    - Whisper Page, [4-635](#)
- Attendant Backup Alerting feature, [4-55](#) to [4-56](#)
- Attendant Call Waiting feature, [4-57](#) to [4-59](#)
  - call waiting ringback tone, [4-483](#)
  - call waiting tones, [4-643](#), [9-33](#)
  - interactions
    - Attendant Direct Extension Selection (DXS) with Busy Light Field, [4-69](#)
    - Attendant Intrusion (Call Offer), [4-83](#)
    - Automatic Call Distribution (ACD), [9-37](#)
    - Automatic Callback (ACB), [4-58](#), [4-101](#)

- Attendant Call Waiting feature, interactions, (cont)
  - Call Coverage, [4-58](#)
  - Call Waiting Termination, [4-245](#)
  - Data Privacy, [4-59](#), [4-301](#)
  - Data Restriction, [4-59](#), [4-304](#)
  - DCS Alphanumeric Display for Terminals, [12-60](#)
  - direct department calling (DDC), [4-59](#)
  - Hunt Groups, [4-371](#)
  - Loudspeaker Paging Access, [4-59](#)
  - Music on Hold Access, [4-59](#)
  - Private Network Access, [12-76](#)
  - QSIG Supplementary Service - Call Completion, [12-93](#), [12-94](#)
  - Recorded Telephone Dictation Access, [4-59](#)
  - Service Observing, [4-550](#)
  - Station Hunting, [4-561](#)
  - Timed Reminder and Attendant Timers, [4-596](#)
  - uniform call distribution (UCD), [4-59](#)
- Attendant Calling of Inward Restricted Stations feature, [4-60](#)
- Attendant Console feature, [4-61](#)
  - adding consoles, [1-7](#)
  - console parameters, [1-7](#)
  - forms, [5-35](#)
  - interactions
    - Abbreviated Dialing (AD), [4-12](#)
    - Call Detail Recording (CDR), [4-213](#)
    - Internal Automatic Answer (IAA), [4-398](#)
    - MF Signaling, [4-442](#)
    - Property Management System (PMS) Interface, [10-28](#)
    - QSIG Supplementary Service - Call Completion, [12-93](#)
    - Ringling—Abbreviated and Delayed, [4-529](#)
- Attendant Console form, [5-35](#) to [5-53](#)
  - 302A and 302B attendant consoles, [5-45](#)
  - 302C attendant consoles, [5-46](#)
  - administration commands, [5-35](#)
  - enhanced selector consoles (26As), [5-47](#)
  - feature button characteristics, [5-48](#)
  - instructions, [5-35](#)
- Attendant Control of Trunk Group Access feature, [4-62](#) to [4-65](#)
  - interactions
    - AAR and ARS, [4-64](#), [8-17](#)
    - Attendant Direct Trunk Group Selection, [4-64](#), [4-73](#)
    - Attendant Display, [4-64](#)
    - Authorization Codes, [4-64](#)
    - Call Vectoring, [9-66](#)
    - Centralized Attendant Service (CAS), [12-8](#)
    - DCS Automatic Callback (ACB), [12-61](#)
    - Inter-PBX Attendant Service (IAS), [12-72](#)
    - Look Ahead Interflow (LAI), [9-101](#)
    - QSIG, [4-64](#)
    - QSIG Supplementary Service - Call Completion, [12-93](#)
    - Tenant Partitioning, [4-575](#)
    - Trunk Group Busy/Warning Indicators to Attendant, [4-64](#)
    - Uniform Dial Plan (UDP), [4-65](#)

- Attendant Crisis Alert feature, [4-66](#) to [4-67](#)
  - crss-alert buttons, [4-66](#)
  - interactions
    - Tenant Partitioning, [4-67](#)
- Attendant Direct Extension Selection (DXS) with Busy Light Field feature, [4-68](#) to [4-71](#)
  - enhanced DXS tracking, [4-70](#)
  - Group Display buttons, [4-70](#)
  - interactions
    - Attendant Call Waiting, [4-69](#)
    - Attendant Display, [4-71](#)
    - Call Coverage, [4-71](#)
    - Centralized Attendant Service (CAS), [4-71](#)
    - DCS Over ISDN–PRI D-Channel (DCS+), [12-64](#)
    - Terminal Self Administration (TSA), [4-580](#)
  - standard DXS tracking, [4-69](#)
- Attendant Direct Trunk Group Selection feature, [4-72](#) to [4-73](#)
  - interactions
    - Attendant Control of Trunk Group Access, [4-64](#), [4-73](#)
    - QSIG, [4-73](#)
- Attendant Display feature, [4-74](#) to [4-82](#)
  - see also* Administrable Language Displays
  - answer supervision timers, [4-76](#)
  - button assignments, [4-75](#)
  - call appearance identification displays, [4-76](#)
  - call progress feedback, [4-77](#)
  - call purpose identifiers
    - Call Coverage, [4-79](#)
    - calls directed, redirected or returned, [4-77](#)
  - call related information, [4-76](#)
  - call types, [4-76](#)
  - called party identification displays, [4-76](#)
  - calling party identification displays, [4-76](#)
  - considerations, [4-82](#)
  - detailed description, [4-74](#)
  - displays modes, [4-74](#)
  - forms, [4-74](#)
  - interactions
    - Attendant Control of Trunk Group Access, [4-64](#)
    - Attendant Direct Extension Selection (DXS) with Busy Light Field, [4-71](#)
    - Attendant Release Loop Operation, [4-89](#)
    - Automatic Wakeup, [10-10](#)
    - Bridged Call Appearance, [4-82](#), [4-117](#)
    - Hospitality Services, [4-82](#)
    - Individual Attendant Access, [4-377](#)
    - Integrated Directory, [4-381](#)
    - Inter-PBX Attendant Service (IAS), [12-72](#)
    - ISDN, [7-38](#)
    - Queue Status Indications, [9-111](#)
    - Single Digit Dialing and Mixed Station Numbering, [4-556](#)
    - Trunk Identification by Attendant, [4-610](#)
    - Whisper Page, [4-635](#)
  - internal COR displays, [4-77](#)
  - sample displays, [4-80](#)
- Attendant features
  - Attendant Automanual Splitting, [4-54](#)
  - Attendant Backup Alerting, [4-55](#)
  - Attendant Call Waiting, [4-57](#)

- Attendant features, (cont)
  - Attendant Calling of Inward Restricted Stations, [4-60](#)
  - Attendant Console, [4-61](#)
  - Attendant Control of Trunk Group Access, [4-62](#)
  - Attendant Crisis Alert, [4-66](#)
  - Attendant Direct Extension Selection (DXS) with Busy Light Field, [4-68](#)
  - Attendant Direct Trunk Group Selection, [4-72](#)
  - Attendant Display, [4-74](#)
  - Attendant Intrusion (Call Offer), [4-83](#)
  - Attendant Override of Diversion Features, [4-84](#)
  - Attendant Priority Queue, [4-85](#)
  - Attendant Recall, [4-88](#)
  - Attendant Release Loop Operation, [4-89](#)
  - Attendant Serial Calling, [4-90](#)
  - Auto Start and Don't Split feature, [4-97](#)
  - Automated Attendant, [4-98](#)
  - Dial Access to Attendant, [4-310](#)
  - Emergency Access to Attendant, [4-318](#)
  - Individual Attendant Access, [4-376](#)
  - Privacy—Attendant Lockout, [4-486](#)
  - Timed Reminder and Attendant Timers, [4-594](#)
  - Trunk Group Busy/Warning Indicators to Attendant, [4-607](#)
  - Trunk Identification by Attendant, [4-609](#)
  - Visually Impaired Attendant Service (VIAS), [4-613](#)
- Attendant Intrusion (Call Offer) feature, [4-83](#)
  - interactions
    - Automatic Call Distribution (ACD), [9-37](#)
    - Automatic Callback (ACB), [4-101](#)
    - Group Paging, [4-354](#)
    - Private Network Access, [12-76](#)
    - Terminal Self Administration (TSA), [4-580](#)
    - Whisper Page, [4-636](#)
- Attendant Override of Diversion Features feature, [4-84](#)
  - interactions
    - Call Forwarding, [4-228](#)
    - Centralized Attendant Service (CAS), [12-8](#)
    - Whisper Page, [4-636](#)
- Attendant Priority Queue feature, [4-85](#) to [4-87](#)
  - attendant call categories, [4-85](#)
  - interactions
    - Administration without Hardware (AWOH), [4-45](#)
    - hunt group night service, [4-87](#)
    - Individual Attendant Access, [4-377](#)
    - multiparty calls, [4-87](#)
    - Off Premises Station, [4-87](#)
  - priorities by call category, [4-85](#)
  - priorities by call types, [4-86](#)
- Attendant Recall feature, [4-88](#)
  - interactions
    - Call Vectoring, [9-66](#)
    - Inter-PBX Attendant Service (IAS), [12-73](#)
    - Privacy—Attendant Lockout, [4-486](#)
- Attendant Release Loop Operation feature, [4-89](#)
  - interactions
    - Administration without Hardware (AWOH), [4-45](#)
    - Terminal Translation Initialization (TTI), [4-588](#)
- Attendant Room Status feature, [10-2](#) to [10-3](#)

- Attendant Serial Calling feature, [4-90](#)
  - interactions
    - Administration without Hardware (AWOH), [4-47](#)
    - Centralized Attendant Service (CAS), [4-91](#), [12-8](#)
    - Distributed Communications System (DCS), [4-91](#)
      - priority queues, [4-91](#)
    - Serial Call buttons, [4-90](#)
- audible alerting, [4-66](#)
- Audible Message Waiting feature, [4-92](#)
- Audichron adjuncts, [4-507](#)
- Audio Difficulty buttons, [9-13](#)
- audio transmission quality, [9-13](#)
- audiotex applications, [9-152](#)
- audit trails, [4-105](#)
- AUDIX
  - call monitoring, [4-623](#)
  - forms
    - Interface Links, [5-179](#)
    - User Defined Adjunct Names, [5-303](#)
  - interactions
    - Abbreviated Dialing (AD), [4-12](#)
    - Auto Available Split (AAS), [9-23](#)
    - Automated Attendant, [4-99](#)
    - Automatic Call Distribution (ACD), [4-622](#)
    - Automatic Circuit Assurance (ACA), [4-106](#)
    - Call Coverage, [4-622](#)
    - Call Detail Recording (CDR), [4-214](#)
    - Call Forwarding, [4-622](#)
    - Call Vectoring, [9-66](#)
    - Class of Restriction (COR), [4-623](#)
    - Conference—Attendant, [4-622](#)
    - DCS Call Coverage, [12-38](#)
    - DCS Leave Word Calling (LWC), [4-623](#)
    - Enhanced Voice Terminal Display, [4-326](#)
    - Expert Agent Selection (EAS), [9-78](#)
    - Leave Word Calling (LWC), [4-408](#), [4-623](#)
    - Property Management System (PMS) Interface, [10-28](#)
    - Pull Transfer, [4-496](#)
    - QSIG Supplementary Service - Call Completion, [12-93](#)
    - Ringback Queuing, [4-624](#)
    - Single Digit Dialing and Mixed Station Numbering, [4-624](#)
    - Temporary Bridged Appearance, [4-624](#)
    - Tenant Partitioning, [4-575](#)
    - Transfer, [4-623](#)
    - Voice Message Retrieval, [4-616](#)
    - Voice Messaging Systems, [4-618](#)
    - Voice Response Integration (VRI), [9-159](#)
- Australia
  - country codes, [6-11](#)
  - Malicious Call Trace (MCT), [4-423](#)
  - World Class Core—BRI, [6-194](#)
- Authorization Code—COR Mapping form, [5-54](#) to [5-55](#)



- Authorization Codes feature, [4-93](#) to [4-96](#)
  - AAR and ARS calls, [4-95](#)
  - authorization codes, [4-510](#)
  - considerations, [4-95](#)
  - forms, [4-93](#), [5-54](#)
  - interactions
    - AAR and ARS, [4-96](#)
    - Attendant Control of Trunk Group Access, [4-64](#)
    - Automated Attendant, [4-99](#)
    - Call Detail Recording (CDR), [4-96](#), [4-214](#)
    - Call Prompting, [9-62](#)
    - Call Vectoring, [9-67](#)
    - CallVisor ASAI, [4-257](#)
    - cancellation of authorization code requests (CACR), [4-96](#)
    - Class of Restriction (COR), [4-96](#)
    - Facility Restriction Levels (FRL) and Traveling Class Marks (TCM), [4-96](#), [8-28](#)
    - forced entry of account codes (FEAC), [4-96](#)
    - Look Ahead Interflow (LAI), [9-101](#)
    - MF Signaling, [4-442](#)
    - Multimedia Call Handling (MMCH), [11-65](#)
    - QSIG Call Forwarding (Diversion), [12-99](#)
    - Remote Access, [4-513](#)
    - Time of Day (TOD) Routing, [8-52](#)
- auto answer terminals, *see under* voice terminals
- Auto Available Split (AAS) feature, [9-22](#) to [9-24](#)
  - interactions
    - Add/Remove Skills, [9-6](#)
    - Agent Call Handling, [9-19](#)
    - AUDIX, [9-23](#)
    - auto answer terminals, [9-23](#)
    - Call Management System (CMS), [9-24](#)
    - Expert Agent Selection (EAS), [9-78](#)
    - Reason Codes, [9-115](#)
    - Redirection on No Answer (RONA), [9-121](#)
    - VDN of Origin Announcement (VOA), [9-149](#)
    - Voice Response Integration (VRI), [9-156](#)
- auto-in work modes, [9-11](#), [9-22](#)
- Auto Start and Don't Split feature, [4-97](#)
  - Don't Split buttons, [4-97](#)
  - interactions
    - Call Detail Recording (CDR), [4-97](#)
    - Visually Impaired Attendant Service (VIAS), [4-97](#), [4-614](#)
- Autodial buttons, [6-16](#)
- Auto-In buttons, [6-16](#)
- Automated Attendant feature, [4-98](#)
  - interactions
    - AUDIX, [4-99](#)
    - Authorization Codes, [4-99](#)
    - Call Prompting, [9-60](#)
    - CallVisor ASAI, [4-99](#)
    - Hold, [4-99](#)
    - Inbound Call Management (ICM), [4-99](#)
    - Transfer, [4-99](#)

- automatic answering
  - agent answering options, [9-10](#)
  - Expert Agent Selection (EAS), [9-79](#)
  - handsets, [9-18](#)
  - headsets, [9-18](#)
  - Internal Automatic Answer (IAA), [4-398](#)
  - Redirection on No Answer (RONA), [9-124](#)
  - speakerphones, [9-18](#)
  - Voice Response Integration (VRI), [9-156](#)
- Automatic Call Distribution (ACD) feature, [9-25](#) to [9-39](#)
  - ACD SD Stroke Count buttons, [6-25](#)
  - ACD splits, *see under* splits
- agents
  - answering options, [9-10](#)
  - considerations, [9-36](#)
  - logins/logouts, [9-9](#), [9-76](#)
  - sizing, [9-34](#)
- announcements, [9-29](#), [9-32](#), [9-34](#)
- Auto-In buttons, [6-16](#)
- call handling preferences, [9-34](#)
- changing hunt groups, [9-36](#)
- considerations, [9-34](#)
- dialed number identification service (DNIS), [9-36](#)
- direct agent calling (DAC), [9-33](#)
- direct department calling (DDC), [9-28](#)
- expert agent distribution (EAD), [9-29](#)
- first announcements, [9-29](#)
- forced disconnects, [9-31](#)
- forced first announcements, [9-30](#)
- forms, [9-27](#)
- interactions
  - Administration without Hardware (AWOH), [4-41](#)
  - Attendant Call Waiting, [9-37](#)
  - Attendant Intrusion (Call Offer), [9-37](#)
  - AUDIX, [4-622](#)
  - Automatic Callback (ACB), [9-37](#)
  - Block Collect Call, [4-110](#)
  - Bridged Call Appearance, [4-117](#)
  - Call Coverage, [4-164](#), [9-37](#)
  - Call Forwarding, [9-37](#)
  - CallVisor ASAI, [4-257](#)
  - Class of Restriction (COR), [9-35](#)
  - Data Call Setup, [9-38](#)
  - Data Restriction, [9-38](#)
  - Distributed Communications System (DCS), [9-38](#)
  - Hold, [9-38](#)
  - hunt group night service, [4-463](#), [9-39](#)
  - Individual Attendant Access, [9-38](#)
  - Intercom—Dial, [9-38](#)
  - Internal Automatic Answer (IAA), [4-398](#), [9-38](#)
  - Intraflow and Interflow, [9-38](#)
  - Multiappearance Preselection and Preference, [9-39](#)
  - Music on Hold Access, [4-456](#)
  - QSIG Supplementary Service - Call Completion, [12-93](#)
  - Ringin—Abbreviated and Delayed, [4-528](#)
  - Send All Calls (SAC), [4-538](#)
  - Service Observing, [9-35](#)

- Automatic Call Distribution (ACD) feature, interactions, (cont)
  - Station Hunting, [4-559](#)
  - Terminal Self Administration (TSA), [4-580](#)
  - Terminating Extension Group (TEG), [9-39](#)
  - Transfer, [9-39](#)
  - Voice Terminal Display, [9-39](#)
- leave word calling messages, [9-35](#)
- MIA across splits/skills, [9-34](#)
- MIA algorithm, [9-28](#)
- preference handling distribution (EAS—PHD), [9-29](#)
- queue status indications, [9-33](#)
- queues, [9-29](#), [9-33](#)
- second announcements, [9-31](#)
- skills, see Expert Agent Selection (EAS)
- split queues, [9-32](#)
- split supervisor, [9-25](#)
- trunk groups, [9-35](#)
- typical arrangements, [9-25](#)
- uniform call distribution (UCD), [9-28](#)
- vector controlled splits, [9-36](#)
- work modes, [9-10](#)
- Automatic Callback (ACB) feature, [4-100](#) to [4-103](#)
  - ACB buttons, [4-100](#)
  - Autocallback buttons, [6-16](#)
  - Automatic Callback buttons, [4-520](#)
  - interactions
    - Administration without Hardware (AWOH), [4-41](#), [4-45](#)
    - Attendant Call Waiting, [4-58](#), [4-101](#)
    - Attendant Intrusion (Call Offer), [4-101](#)
    - Automatic Call Distribution (ACD), [9-37](#)
    - Bridged Call Appearance, [4-101](#), [4-117](#)
    - Busy Verification of Terminals and Trunks (Verify), [4-102](#), [4-133](#)
    - Call Coverage, [4-102](#), [4-162](#)
    - Call Detail Recording (CDR), [4-215](#)
    - Call Forwarding, [4-102](#), [4-228](#)
    - Call Pickup, [4-102](#), [4-238](#)
    - Call Vectoring, [9-67](#)
    - Call Waiting Termination, [4-101](#), [4-245](#)
    - CallVisor ASAI, [4-257](#)
    - Class of Restriction (COR), [4-102](#)
    - Conference—Terminal, [4-102](#)
    - DCS Alphanumeric Display for Terminals, [12-60](#)
    - DCS Call Waiting, [12-63](#)
    - Distributed Communications System (DCS), [4-102](#)
    - Do Not Disturb (DND), [10-13](#)
    - Group Paging, [4-354](#)
    - Hold, [4-102](#), [4-360](#)
    - Hotline Service, [4-102](#)
    - Hunt Groups, [4-371](#)
    - Intercom—Automatic, [4-102](#)
    - Intercom—Dial, [4-102](#)
    - Internal Automatic Answer (IAA), [4-102](#), [4-399](#)
    - Last Number Dialed, [4-404](#)
    - Manual Originating Line Service, [4-102](#)
    - Ringback Queuing, [4-102](#), [4-521](#)
    - Ringer Cutoff, [4-524](#)

- Automatic Callback (ACB) feature, interactions, (cont)
  - Ringling—Abbreviated and Delayed, [4-528](#)
  - Send All Calls (SAC), [4-538](#)
  - Station Hunting, [4-560](#)
  - Terminal Self Administration (TSA), [4-580](#)
  - Terminal Translation Initialization (TTI), [4-588](#)
  - Terminating Extension Group (TEG), [4-592](#)
  - Transfer, [4-102](#)
  - Voice Terminal Display, [4-103](#)
- automatic calling unit (ACU) interface modules, [4-291](#)
- Automatic Circuit Assurance (ACA) feature, [4-104](#) to [4-107](#)
  - ACA buttons, [12-34](#)
  - ACA-halt buttons, [4-105](#)
  - audit trail records, [4-105](#)
  - Auto-Ckt assure buttons, [6-15](#)
  - interactions
    - Administrable Language Displays, [4-106](#)
    - AUDIX, [4-106](#)
    - Busy Verification of Terminals and Trunks (Verify), [4-106](#)
    - Call Detail Recording (CDR), [4-215](#)
    - Centralized Attendant Service (CAS), [4-106](#)
    - Distributed Communications System (DCS), [4-106](#)
    - Internal Automatic Answer (IAA), [4-106](#), [4-399](#)
    - Look Ahead Routing (LAR), [8-47](#)
    - night console service, [4-106](#)
    - Ringling—Abbreviated and Delayed, [4-528](#)
    - Visually Impaired Attendant Service (VIAS), [4-106](#)
    - Voice Message Retrieval, [4-107](#)
    - Wideband Switching, [4-107](#), [7-68](#)
  - message information, [4-105](#)
  - referral calls, [4-105](#)
- automatic dialing buttons, [4-1](#), [4-8](#)
- Automatic Incoming Call Display feature, [4-108](#)
  - interactions
    - Call Charge Information, [4-142](#)
    - Multiappearance Preselection and Preference, [4-454](#)
    - station type PC/PBXs, [4-109](#)
    - trunk groups, [4-109](#)
    - Voice Terminal Display, [4-109](#)
    - Whisper Page, [4-636](#)
- automatic message waiting buttons, [10-8](#)
- automatic number identification (ANI), [4-440](#)
- Automatic Routing features
  - AAR and ARS, [8-3](#)
  - AAR and ARS Overlap Sending, [8-20](#)
  - AAR and ARS Partitioning, [8-21](#)
  - Alternate Facility Restriction Levels (AFRL), [8-29](#)
  - Facility Restriction Levels (FRL), [8-24](#)
  - Generalized Route Selection (GRS), [8-33](#)
  - Look Ahead Routing (LAR), [8-45](#)
  - Subnet Trunking, [8-48](#)
  - Time of Day (TOD) Routing, [8-50](#)
  - Traveling Class Marks (TCM), [8-24](#)
- Automatic Routing forms, [8-54](#)

- Automatic Transmission Measurement System (ATMS) feature, [7-2](#) to [7-10](#)
  - ATMS Trunk Test Schedule form, [7-2](#)
  - busyout limits, [7-3](#)
  - considerations, [7-10](#)
  - detailed description, [7-2](#)
  - determining per trunk test time by test objectives, [7-5](#)
  - determining schedule times, [7-4](#)
  - determining types of tests by trunk characteristics, [7-4](#)
  - forms, [7-2](#)
  - interactions, [7-10](#)
  - managing OTL/TTL resources, [7-7](#)
  - terminating test lines (TTL), [7-3](#)
  - test schedule example, [7-7](#)
- Automatic Wakeup feature, [10-4](#) to [10-10](#)
  - audit trail records, [10-8](#)
  - Automatic Wakeup buttons, [10-6](#)
  - Autowakeup-Alm buttons, [6-23](#)
  - Autowakeup buttons, [6-16](#)
  - barge in, [10-9](#)
  - considerations, [10-10](#)
  - daily reports, [10-9](#)
  - detailed description, [10-5](#)
  - display prompting, [10-6](#), [10-7](#)
  - forms, [5-194](#), [10-4](#)
  - interactions
    - Attendant Display, [10-10](#)
    - Call Detail Recording (CDR), [4-216](#)
    - Call Park, [4-234](#)
    - Do Not Disturb (DND), [10-10](#), [10-13](#)
    - Property Management System (PMS) Interface, [10-10](#), [10-28](#)
    - Recorded Announcement, [4-507](#)
    - Tenant Partitioning, [4-575](#)
    - Terminal Self Administration (TSA), [4-580](#)
    - VDN of Origin Announcement (VOA), [9-150](#)
    - voice synthesizers, [10-10](#)
    - Voice Terminal Display, [10-10](#)
  - language displays, [4-21](#)
  - LWC messages, [10-7](#)
  - multiple announcements, [10-9](#)
  - request denial, [10-7](#)
  - speech synthesizer boards, [10-6](#)
  - vector directory numbers (VDNs), [10-9](#)
  - voice prompting, [10-6](#)
  - Wakeup Activity reports, [10-9](#)
  - wakeup messages extensions, [10-7](#)
  - Wakeup Summary reports, [10-9](#)
- autorestorations, [4-17](#)
- auxiliary (AUX) work modes
  - Agent Call Handling, [9-9](#)
  - lights, [9-11](#)
  - Reason Codes, [9-112](#), [9-113](#)
  - Redirection on No Answer (RONA), [9-116](#)
  - skills, [9-116](#)
  - splits, [9-11](#), [9-116](#)
- Auxiliary Board for Announcement, [10-33](#)
- auxiliary queue warning lights, [9-111](#)
- auxiliary trunks (aux-trunks), [9-148](#)
- Auxiliary Work buttons, [6-17](#), [9-36](#)

---

## B

B8ZS DS1 circuit packs, [7-75](#)

backup

command operation, [2-30](#), [2-35](#)

completion status screen, [2-32](#)

disk command, [2-31](#)

memory card related failures, [2-21](#)

Backup buttons, [12-5](#)

Backup Completion Station screen, [2-33](#)

barge in, [4-503](#), [10-9](#)

barrier codes, [4-510](#), [4-511](#), [11-65](#)

Basic Call Management System (BCMS) feature, [9-40](#) to [9-43](#)

interactions

Add/Remove Skills, [9-5](#), [9-6](#)

Best Service Routing (BSR), [9-55](#)

Block Collect Call, [4-110](#)

Call Management System (CMS), [9-42](#)

Look Ahead Interflow (LAI), [9-101](#)

Night Service, [9-42](#)

QSIG Additional Network Feature Path Replacement (ANF-PR), [12-101](#)

Reason Codes, [9-115](#)

Redirection on No Answer (RONA), [9-119](#)

Service Observing, [4-550](#)

system measurements, [9-42](#)

Voice Response Integration (VRI), [9-156](#)

VuStats, [9-190](#)

Wideband Switching, [7-69](#)

reports, [9-40](#)

statistics, [9-161](#)

basic encoding rules (BER), [12-79](#)

basic multimedia complex, [11-31](#)

BCMS Split (AGENT) Status report, [9-119](#)

BCMS/VuStats Login IDs form, [9-200](#) to [9-201](#)

BCS Products Security Handbook, [3-1](#)

bearer capability classes (BCC), [4-202](#), [8-34](#), [8-42](#)

bearer capability information elements (BCIE), [8-37](#), [8-72](#)

bearer channels (B-channels), [4-382](#)

Bellcore National ISDN protocols

ISDN-1 protocol, [6-194](#)

ISDN-2 protocol, [7-32](#)

Best Service Routing (BSR) feature, [9-44](#) to [9-57](#)

administering multi-site BSR, [9-48](#)

administering single-site BSR, [9-48](#)

benefits of, [9-44](#)

call vectoring, [9-49](#)

agent surplus situations, [9-50](#)

call surplus situations, [9-49](#)

commands for multi-site BSR, [9-53](#)

commands for single-site BSR, [9-51](#)

interactions

Agent Terminal Display, [9-55](#)

Basic Call Management System (BCMS), [9-55](#)

BSR/LAI, [9-55](#)

Call Vectoring, [9-55](#)

- Best Service Routing (BSR) feature, interactions, (cont)
  - Direct Department Calling, [9-56](#)
  - Expert Agent Selection (EAS), [9-56](#)
  - Facility Restriction Levels, [9-56](#)
  - Information Forwarding, [9-89](#)
  - ISDN, [9-56](#)
  - Manufacturer Specific Information (MSI), [9-56](#)
  - Multi-Split/Skill Queuing, [9-56](#)
  - Network Access, [9-56](#)
  - Operating Support System Interface (OSSI), [9-56](#)
  - QSIG, [9-57](#)
  - Redirection on No Answer (RONA), [9-57](#)
  - Service Observing, [9-57](#)
  - Transfer, [9-57](#)
  - Trunk Code Access (TAC), [9-57](#)
  - VDN Override, [9-57](#)
  - VDN Return Destination, [9-57](#)
  - VuStats, [9-57](#)
- network requirements, [9-47](#)
- switch requirements, [9-46](#)
- types of, [9-44](#)
- billing rate changes, [4-345](#)
- bit oriented signaling (BOS), [7-11](#), [7-19](#), [7-120](#), [7-188](#)
- blank station forms, [1-4](#)
- Block Collect Call feature, [4-110](#) to [4-111](#)
  - interactions
    - Automatic Call Distribution (ACD), [4-110](#)
    - Basic Call Management System (BCMS), [4-110](#)
    - busy tone forward disconnect (BTFD), [4-111](#)
    - Call Coverage, [4-111](#)
    - Call Forwarding, [4-111](#)
    - Call Vectoring, [4-111](#)
    - Distributed Communications System (DCS), [4-111](#)
    - electronic tandem networks (ETN), [4-111](#)
    - Remote Access, [4-111](#)
    - Voice Terminal Display, [4-111](#)
- blocking, [7-67](#)
- BRI platform (international), [6-194](#)
- Bridged Call Appearance feature, [4-112](#) to [4-127](#)
  - considerations
    - multiappearance voice terminals, [4-116](#)
    - single line voice terminals, [4-115](#)
  - detailed description, [4-113](#)
  - extension administrable buttons and lights, [4-113](#)
  - forms, [4-112](#)
  - interactions
    - AAR and ARS Partitioning, [8-22](#)
    - Abbreviated Dialing (AD), [4-12](#), [4-116](#)
    - Administration without Hardware (AWOH), [4-41](#), [4-45](#)
    - Agent Call Handling, [9-19](#)
    - Attendant Display, [4-82](#), [4-117](#)
    - Automatic Call Distribution (ACD), [4-117](#)
    - Automatic Callback (ACB), [4-101](#), [4-117](#)
    - Call Charge Information, [4-142](#)
    - Call Coverage, [4-117](#), [4-162](#)
    - Call Detail Recording (CDR), [4-118](#), [4-216](#)

Bridged Call Appearance feature, interactions, (cont)

- Call Forwarding, [4-229](#)
- call forwarding—all calls, [4-118](#)
- call forwarding busy/don't answer, [4-118](#)
- Call Park, [4-118](#), [4-234](#)
- Call Pickup, [4-118](#), [4-239](#)
- Call Vectoring, [9-67](#)
- Call Waiting Termination, [4-120](#)
- CallVisor ASAI, [4-116](#), [4-257](#)
- Class of Restriction (COR), [4-120](#), [4-274](#)
- Conference—Attendant, [4-120](#), [4-282](#)
- Conference—Terminal, [4-120](#), [4-284](#)
- Consult, [4-122](#), [4-286](#)
- coverage answer groups, [4-122](#)
- Data Privacy, [4-122](#), [4-301](#)
- Data Restriction, [4-122](#)
- deluxe paging, [4-418](#)
- Extended User Administration of Redirected Calls, [4-338](#)
- Facility Busy Indication, [4-122](#)
- Group Paging, [4-355](#)
- Hold, [4-360](#)
- Hold—Automatic, [4-123](#)
- Hotline Service, [4-123](#), [4-364](#)
- Hunt Groups, [4-123](#)
- Individual Attendant Access, [4-377](#)
- Intercom—Automatic, [4-124](#)
- Intercom—Dial, [4-124](#)
- Internal Automatic Answer (IAA), [4-124](#), [4-399](#)
- ISDN, [7-38](#)
- Last Number Dialed, [4-124](#), [4-404](#)
- Leave Word Calling (LWC), [4-124](#), [4-408](#)
- Malicious Call Trace (MCT), [4-426](#)
- MF Signaling, [4-442](#)
- Misoperation Handling, [4-448](#)
- Multiappearance Preselection and Preference, [4-124](#)
- Multimedia Call Handling (MMCH), [11-65](#), [11-86](#)
- personal central office lines (PCOL), [4-124](#)
- Personal Station Access (PSA), [4-478](#)
- Priority Calling, [4-125](#), [4-484](#)
- Privacy—Manual Exclusion, [4-125](#), [4-487](#)
- QSIG Supplementary Service - Call Completion, [12-94](#)
- redirection notification, [4-125](#)
- Ringback Queuing, [4-125](#), [4-521](#)
- Ringer Cutoff, [4-125](#), [4-524](#)
- Ringin—Abbreviated and Delayed, [4-125](#)
- Service Observing, [4-125](#), [4-550](#)
- Station Hunting, [4-560](#)
- Tenant Partitioning, [4-575](#)
- Terminal Translation Initialization (TTI), [4-589](#)
- Terminating Extension Group (TEG), [4-126](#), [4-592](#)
- Time of Day (TOD) Routing, [8-52](#)
- Transfer, [4-126](#)
- Videophone 2500, [4-127](#)
- Voice Message Retrieval, [4-127](#), [4-617](#)



- Bridged Call Appearance feature, interactions, (cont)
  - voice paging, [4-127](#)
  - Voice Terminal Alerting Options, [4-625](#)
  - Voice Terminal Display, [4-117](#), [4-632](#)
  - Whisper Page, [4-637](#)
- multiappearance voice terminals, [4-113](#)
- sample applications, [4-114](#)
- British English, [4-613](#)
- Broadcast Music Incorporated (BMI), [4-568](#)
- btn-view buttons, [4-135](#)
- built-in speakerphone voice terminals, *see* 7313H (BIS-10), 7314H (BIS-22), 7315H (BIS-22D), 7316H (BIS-34) and 7317H (BIS-34D) voice terminals
- Bulletin Board feature, [4-128](#) to [4-129](#)
- Bulletin Board form, [5-56](#) to [5-57](#)
- Busy Indicator buttons, [6-17](#), [12-8](#)
- busy light fields, [4-69](#), [4-72](#), [4-608](#), [12-52](#)
- Busy name, [12-80](#)
- busy tone forward disconnect (BTFD), [4-111](#), [4-388](#)
- Busy Verification of Terminals and Trunks (Verify) feature, [4-130](#) to [4-133](#)
  - interactions
    - Administered Connections (AC), [4-18](#)
    - Administration without Hardware (AWOH), [4-41](#)
    - Automatic Callback (ACB), [4-102](#), [4-133](#)
    - Automatic Circuit Assurance (ACA), [4-106](#)
    - Call Coverage, [4-133](#)
    - Call Detail Recording (CDR), [4-216](#)
    - Call Forwarding, [4-133](#)
    - Call Vectoring, [9-67](#)
    - Call Waiting Termination, [4-133](#)
    - Conference—Attendant, [4-133](#)
    - Conference—Terminal, [4-133](#)
    - Data Privacy, [4-134](#), [4-301](#)
    - Data Restriction, [4-134](#), [4-304](#)
    - Hold, [4-134](#)
    - Individual Attendant Access, [4-134](#), [4-377](#)
    - Loudspeaker Paging Access, [4-134](#)
    - Ringin—Abbreviated and Delayed, [4-528](#)
    - Service Observing, [4-550](#)
    - Station Hunting, [4-560](#)
    - Terminal Self Administration (TSA), [4-581](#)
    - Transfer, [4-134](#)
    - Trunk Identification by Attendant, [4-610](#)
    - voice terminal origination restrictions, [4-134](#)
    - voice terminal termination restrictions, [4-134](#)
    - Whisper Page, [4-638](#)
- language displays, [4-22](#)
- verification
  - ACD splits, [4-132](#)
  - DDC groups, [4-132](#)
  - trunk groups, [4-132](#)
  - UCD groups, [4-132](#)
  - voice terminals, [4-130](#)
- Verify buttons, [4-130](#), [6-26](#), [12-35](#)
- busyout limits, [7-3](#)

button assignments

- Agent Call Handling, [9-17](#)
- attendant consoles, [5-44](#), [5-48](#)
- VDN extensions, [9-66](#)
- Voice Terminal Display, [4-626](#)

Button View feature, [4-135](#)

BX.25 data modules, *see* X.25 data modules

BX.25 protocols, [7-29](#)

---

## C

Cabinet form, [5-58](#) to [5-60](#)

call appearance

- buttons, [4-76](#), [4-361](#), [4-628](#)
- Intercom—Automatic, [4-393](#)
- Intercom—Dial, [4-395](#)
- status buttons, [4-237](#)

call associated—temporary signaling connections (CA—TSC), [12-48](#), [12-79](#)

Call by Call (CBC) Service Selection feature, [7-42](#) to [7-47](#)

considerations, [7-47](#)

example, [7-44](#)

forms, [7-42](#), [8-67](#)

incoming call handling treatment, [7-46](#)

information elements (IE), [7-45](#)

interactions

- AAR and ARS, [7-47](#)
- Call Detail Recording (CDR), [4-216](#), [7-48](#)
- Generalized Route Selection (GRS), [7-48](#)
- multiquest flexible billing, [7-48](#)
- Time of Day (TOD) Routing, [7-48](#)
- traffic measurements, [7-48](#)

ISDN—PRI messages and information elements, [7-45](#)

usage allocation plans (UAP), [7-45](#)

Call Center features

- Abandoned Call Search, [9-3](#)
- Add/Remove Skills, [9-5](#)
- Agent Call Handling, [9-7](#)
- Auto Available Split (AAS), [9-22](#)
- Automatic Call Distribution (ACD), [9-25](#)
- Basic Call Management System (BCMS), [9-40](#)
- Best Service Routing (BSR), [9-44](#)
- Call Management System (CMS), [9-58](#)
- Call Prompting, [9-60](#)
- Call Vectoring, [9-63](#)
- Expert Agent Selection (EAS), [9-72](#)
- Inbound Call Management (ICM), [9-81](#)
- Information Forwarding, [9-89](#)
- Intraflow and Interflow, [9-89](#)
- Look Ahead Interflow (LAI), [9-98](#)
- Multiple Call Handling (MCH), [9-104](#)
- Queue Status Indications, [9-110](#)
- Reason Codes, [9-112](#)
- Redirection on No Answer (RONA), [9-116](#)
- Universal Call ID (UCID), [9-130](#)
- VDN in a Coverage Path (VICP), [9-130](#)
- VDN of Origin Announcement (VOA), [9-146](#)
- Voice Response Integration (VRI), [9-152](#)
- VuStats, [9-161](#)

- Call Center System Parameters form, [9-202](#)
- Call Charge Information feature, [4-136](#) to [4-142](#)
  - advice of charge (AOC)
    - description, [4-136](#)
    - forms, [4-137](#)
  - attendant consoles, [4-141](#)
  - button operations, [4-142](#)
- Call Detail Recording (CDR)
  - forms, [4-139](#)
  - reports, [4-136](#)
- charge displays
  - description, [4-136](#)
  - forms, [4-140](#)
- considerations, [4-141](#)
- detailed description, [4-141](#)
- interactions, [4-142](#)
  - attendant features, [4-142](#)
  - Automatic Incoming Call Display, [4-142](#)
  - Bridged Call Appearance, [4-142](#)
  - Call Coverage, [4-143](#)
  - Call Forwarding, [4-143](#)
  - Call Park, [4-143](#)
  - call preserving software updates, [4-144](#)
  - CDR Adjuncts, [4-143](#)
  - CDR Call Splitting, [4-143](#)
  - Centralized Attendant Service (CAS), [4-144](#)
  - Conference—Attendant, [4-144](#)
  - Conference—Terminal, [4-144](#)
  - Distributed Communications System (DCS), [4-144](#)
  - electronic tandem networks (ETN), [4-144](#)
  - Enhanced Voice Terminal Display, [4-144](#)
  - Hold, [4-144](#)
  - Last Number Dialed, [4-144](#)
  - QSIG, [4-144](#)
  - system resets, [4-144](#)
  - Transfer, [4-143](#)
- performance impact, [4-141](#)
- Periodic Pulse Metering (PPM)
  - description, [4-136](#)
  - forms, [4-138](#)
- call classification answer detection, [4-52](#)
- Call Coverage feature, [4-146](#) to [4-161](#)
  - call purpose identifier displays, [4-79](#)
  - call redirection examples, [4-154](#)
  - considerations, [4-157](#)
  - coverage answer groups, [4-45](#), [4-153](#)
  - Coverage buttons, [6-21](#)
  - coverage paths, [4-148](#), [4-160](#)
  - coverage subsequent redirection intervals, [4-148](#)
  - covering user options, [4-152](#)
  - detailed description, [4-147](#)
  - directed call pickup, [4-152](#)
  - forms, [4-146](#), [5-92](#), [5-94](#)
  - guidelines, [4-157](#)

Call Coverage feature, (cont)  
interactions

- Administration without Hardware (AWOH), [4-42](#), [4-45](#), [4-162](#)
- Agent Call Handling, [4-162](#), [9-19](#)
- Attendant Call Waiting, [4-58](#)
- Attendant Direct Extension Selection (DXS) with Busy Light Field, [4-71](#)
- AUDIX, [4-622](#)
- Automatic Call Distribution (ACD), [4-164](#), [9-37](#)
- Automatic Callback (ACB), [4-102](#), [4-162](#)
- Block Collect Call, [4-111](#)
- Bridged Call Appearance, [4-117](#), [4-162](#)
- Busy Verification of Terminals and Trunks (Verify), [4-133](#)
- Call Charge Information, [4-143](#)
- Call Detail Recording (CDR), [4-163](#), [4-216](#)
- Call Forwarding, [4-163](#), [4-229](#)
- Call Pickup, [4-163](#), [4-239](#)
- Call Vectoring, [9-67](#)
- CallVisor ASAI, [4-258](#), [4-259](#)
- Centralized Attendant Service (CAS), [4-163](#), [12-8](#)
- Class of Restriction (COR), [4-163](#), [4-274](#)
- Conference—Attendant, [4-164](#)
- Conference—Terminal, [4-164](#)
- Consult, [4-152](#), [4-286](#)
- Coverage Callback, [4-153](#), [4-287](#)
- Coverage Incoming Call Identification (ICI), [4-153](#), [4-288](#)
- Data Call Setup, [4-296](#)
- DCS Alphanumeric Display for Terminals, [12-60](#)
- DCS Call Coverage, [12-62](#)
- deluxe paging, [4-418](#)
- direct department calling (DDC), [4-164](#)
- Do Not Disturb (DND), [10-13](#)
- Extended User Administration of Redirected Calls, [4-157](#), [4-338](#)
- Group Paging, [4-355](#)
- Hold, [4-164](#)
- hunt group night service, [4-463](#)
- Individual Attendant Access, [4-377](#)
- Intercom—Automatic, [4-162](#), [4-393](#)
- Intercom—Dial, [4-162](#), [4-396](#)
- Internal Automatic Answer (IAA), [4-164](#), [4-399](#)
- Inter-PBX Attendant Service (IAS), [12-73](#)
- Intraflow and Interflow, [9-97](#)
- Leave Word Calling (LWC), [4-164](#), [4-408](#)
- Multippearance Preselection and Preference, [4-454](#)
- Multimedia Call Handling (MMCH), [11-66](#)
- Names Registration, [10-19](#)
- Night Service, [4-165](#)
- night station service, [4-464](#)
- Personal Station Access (PSA), [4-479](#)
- Priority Calling, [4-162](#), [4-484](#)
- Privacy—Manual Exclusion, [4-165](#), [4-487](#)
- QSIG Call Forwarding (Diversion), [12-100](#)
- QSIG Supplementary Service - Call Completion, [12-94](#)
- Redirection on No Answer (RONA), [9-124](#)
- Restriction—Controlled, [4-163](#), [4-519](#)

- Call Coverage feature, interactions, (cont)
  - Ringback Queuing, [4-162](#), [4-521](#)
  - Ringling—Abbreviated and Delayed, [4-529](#)
  - Security Violation Notification (SVN), [4-537](#)
  - Send All Calls (SAC), [4-538](#)
  - Service Observing, [4-550](#)
  - Station Hunting, [4-560](#)
  - Temporary Bridged Appearance, [4-165](#), [4-567](#)
  - Tenant Partitioning, [4-165](#), [4-575](#)
  - Terminal Self Administration (TSA), [4-581](#)
  - Terminal Translation Initialization (TTI), [4-589](#)
  - Terminating Extension Group (TEG), [4-592](#)
  - Timed Reminder and Attendant Timers, [4-596](#)
  - Transfer, [4-165](#)
  - trunk answer from any station (TAAS), [4-465](#)
  - uniform call distribution (UCD), [4-164](#)
  - VDN of Origin Announcement (VOA), [9-150](#)
  - Wideband Switching, [7-69](#)
- measurements and reports, [4-157](#)
- message retrieval display modes, [4-75](#)
- multiple coverage paths, [4-148](#)
- overrides
  - conditions, [4-151](#)
  - system features, [4-150](#)
- redirection criteria and conditions, [4-149](#)
- remote off net call coverage, [4-155](#)
- switch communication interface (SCI) links, [4-156](#)
- time of day coverage table, [4-153](#)
- typical coverage arrangements, [4-157](#)
- VDN in a Coverage Path (VICP), [4-156](#)
- Call Detail Recording (CDR) feature, [4-167](#) to [4-223](#)
  - account code dialing
    - Auto Start and Don't Split, [4-97](#)
    - description, [4-170](#)
    - forms, [4-168](#)
  - call disconnect data, [4-208](#)
  - call splitting for incoming and outgoing trunks
    - attendant call recording, [4-174](#)
    - Call Charge Information, [4-143](#)
    - description, [4-172](#)
    - forms, [4-169](#)
    - incoming trunk examples, [4-172](#)
    - outgoing trunk examples, [4-174](#)
- CDR Failure buttons, [6-18](#)
- CDR Privacy, [4-170](#), [4-176](#)
- considerations, [4-213](#)
- date and time, [4-213](#)
- date record formats, [4-178](#)
- detailed description, [4-170](#)
- encoding for TSC flags, [4-212](#)
- forced entry of account codes (FEAC)
  - AAR and ARS, [8-18](#)
  - Authorization Codes, [4-96](#)
  - Call Forwarding, [4-229](#)

Call Detail Recording (CDR) feature, forced entry of account codes (FEAC), (cont)

Call Vectoring, [9-69](#)

Class of Restriction (COR), [4-274](#)  
description, [4-171](#)

forms, [4-168](#)

forms, [4-167](#), [5-177](#), [5-183](#), [5-299](#)

interactions

AAR and ARS, [4-215](#), [8-18](#)

AAR and ARS Partitioning, [8-22](#)

Abbreviated Dialing (AD), [4-213](#)

Administered Connections (AC), [4-18](#)

Answer Detection, [4-53](#), [4-213](#)

Attendant Console, [4-213](#)

AUDIX, [4-214](#)

Authorization Codes, [4-96](#), [4-214](#)

Automatic Callback (ACB), [4-215](#)

Automatic Circuit Assurance (ACA), [4-215](#)

Automatic Wakeup, [4-216](#)

Bridged Call Appearance, [4-118](#), [4-216](#)

Busy Verification of Terminals and Trunks (Verify), [4-216](#)

Call by Call (CBC) Service Selection, [4-216](#), [7-48](#)

Call Charge Information, [4-143](#)

Call Coverage, [4-163](#), [4-216](#)

Call Forwarding, [4-229](#)

call forwarding—all calls, [4-216](#)

Call Park, [4-217](#)

Call Pickup, [4-217](#), [4-239](#)

Call Vectoring, [4-217](#), [9-68](#)

Call Waiting Termination, [4-218](#)

CallVisor ASAI, [4-258](#), [4-260](#)

Centralized Attendant Service (CAS), [4-218](#), [12-8](#)

CO trunks, [4-218](#)

Conference, [4-218](#)

Data Call Setup, [4-296](#)

DCS Over ISDN—PRI D-Channel (DCS+), [12-64](#)

DID trunks, [4-219](#)

Distributed Communications System (DCS), [4-219](#)

Emergency Access to Attendant, [4-219](#)

Expert Agent Selection (EAS), [4-219](#)

Facility Restriction Levels (FRL) and Traveling Class Marks (TCM), [8-28](#)

Flexible Billing, [4-346](#)

FX trunks, [4-219](#)

Hotline Service, [4-219](#)

Hunt Groups, [4-219](#), [4-371](#)

Intercept Treatment, [4-219](#)

Intercom—Automatic, [4-220](#)

Intercom—Dial, [4-220](#)

Inter-PBX Attendant Service (IAS), [4-220](#)

ISDN, [4-220](#)

Last Number Dialed, [4-220](#)

Listed Directory Numbers (LDN), [4-220](#)

Look Ahead Interflow (LAI), [9-101](#)

Manual Originating Line Service, [4-220](#)

MF Signaling, [4-442](#)

Modem Pooling, [4-451](#)

- Call Detail Recording (CDR) feature, interactions, (cont)
  - Multimedia Call Handling (MMCH), [11-66](#), [11-86](#)
  - Night Service, [4-220](#)
  - Off Premises Station, [4-221](#)
  - personal central office lines (PCOL), [4-221](#)
  - planned interchange on duplicated Release 5r, [4-221](#)
  - Private Network Access, [4-221](#)
  - Pull Transfer, [4-496](#)
  - QSIG Additional Network Feature Path Replacement (ANF-PR), [12-101](#)
  - QSIG Call Forwarding (Diversion), [12-100](#)
  - Redirection on No Answer (RONA), [9-125](#)
  - Remote Access, [4-221](#)
  - Ringback Queuing, [4-221](#)
  - Security Violation Notification (SVN), [4-221](#)
  - Service Observing, [4-221](#)
  - Station Hunting, [4-560](#)
  - system date and time, [2-17](#)
  - tandem tie trunk switching, [4-221](#)
  - Temporary Bridged Appearance, [4-222](#)
  - temporary signaling connections (TSC), [4-222](#)
  - Tenant Partitioning, [4-576](#)
  - tie trunk access, [4-222](#)
  - Time of Day (TOD) Routing, [8-52](#)
  - Transfer, [4-222](#)
  - Trunk to Trunk Transfer, [4-223](#)
  - Uniform Dial Plan (UDP), [4-223](#)
  - VDN return destination, [4-223](#)
  - Voice Response Integration (VRI), [9-156](#)
  - WATS and 800 Service, [4-223](#)
  - Wideband Switching, [7-69](#)
- intraswitch CDR, [9-157](#)
  - description, [4-175](#)
  - forms, [4-170](#)
- language displays, [4-22](#)
- network specific facility to INS mapping, [4-209](#)
- output, [4-176](#)
- record formats
  - condition code override matrix, [4-205](#)
  - condition codes, [4-203](#)
  - customized formats, [4-179](#)
  - data format—59 character, [4-183](#)
  - data format—enhanced expanded, [4-193](#)
  - data format—enhanced LSU, [4-190](#)
  - data format—enhanced printer, [4-186](#)
  - data format—enhanced TELESEER, [4-182](#)
  - data format—enhanced unformatted, [4-196](#)
  - data format—expanded, [4-191](#)
  - data format—Int process, [4-197](#)
  - data format—Int-direct, [4-198](#)
  - data format—Int-ISDN, [4-199](#)
  - data format—ISDN LSU, [4-189](#)
  - data format—ISDN printer, [4-185](#)
  - data format—ISDN TELESEER, [4-181](#)
  - data format—LSU, [4-188](#)
  - data format—LSU-expand, [4-187](#)

Call Detail Recording (CDR) feature, record formats, (cont)

- data format—printer, [4-184](#)
- data format—TELESEER, [4-180](#)
- data format—unformatted, [4-195](#)
- date record formats, [4-177](#)
- record field descriptions, [4-201](#)

- security alerts, [4-171](#)
- security measures, [4-213](#)
- valid data item entries, [5-68](#)

Call Display buttons, [4-75](#), [4-628](#)

Call Forwarding feature, [4-224](#) to [4-228](#)

call forwarding—all calls

- AAR and ARS Partitioning, [8-22](#)
- Automatic Call Distribution (ACD), [9-37](#)
- Bridged Call Appearance, [4-118](#)
- buttons, [4-226](#)
- Call Detail Recording (CDR), [4-216](#)
- Class of Restriction (COR), [4-274](#)
- Data Call Setup, [4-296](#)
- Data Hotline, [4-300](#)
- description, [4-224](#), [4-225](#), [4-369](#)
- Do Not Disturb (DND), [10-13](#)
- end user procedures, [4-226](#)
- Night Service, [4-463](#)
- night station service, [4-464](#)
- Priority Calling, [4-484](#)
- Redirection on No Answer (RONA), [9-125](#)
- Ringback Queuing, [4-522](#)
- Ringer Cutoff, [4-524](#)
- trunk answer from any station (TAAS), [4-465](#)
- trunk group night service, [4-465](#)

call forwarding busy/don't answer

- Bridged Call Appearance, [4-118](#)
- buttons, [4-226](#)
- Call Forwarding bsyda buttons, [6-18](#)
- description, [4-224](#), [4-225](#)
- end user procedures, [4-226](#)
- Ringin—Abbreviated and Delayed, [4-529](#)
- Terminal Self Administration (TSA), [4-581](#)

Call Forwarding buttons, [6-17](#)

call forwarding off net

- coverage of calls redirected off net, [4-224](#)
- description, [4-224](#), [4-226](#), [4-228](#)

call forwarding override, [4-224](#), [4-226](#)

considerations, [4-227](#)

forms, [4-224](#)

interactions

- Administered Connections (AC), [4-18](#)
- Administration without Hardware (AWOH), [4-42](#), [4-46](#)
- Agent Call Handling, [9-19](#)
- Answer Detection, [4-228](#)
- Attendant Override of Diversion Features, [4-228](#)
- AUDIX, [4-622](#)
- Automatic Callback (ACB), [4-102](#), [4-228](#)
- Block Collect Call, [4-111](#)
- Bridged Call Appearance, [4-229](#)



- Call Forwarding feature, interactions, (cont)
  - Busy Verification of Terminals and Trunks (Verify), [4-133](#)
  - Call Charge Information, [4-143](#)
  - Call Coverage, [4-163](#), [4-229](#)
  - Call Detail Recording (CDR), [4-229](#)
  - Call Park, [4-229](#)
  - Call Pickup, [4-229](#), [4-239](#)
  - Call Prompting, [4-230](#)
  - Call Vectoring, [9-67](#)
  - CallVisor ASAI, [4-230](#), [4-258](#)
  - Centralized Attendant Service (CAS), [12-8](#)
  - Conference—Attendant, [4-230](#)
  - Conference—Terminal, [4-230](#)
  - DCS Alphanumeric Display for Terminals, [12-60](#)
  - DCS Automatic Callback (ACB), [12-61](#)
  - direct inward dialing (DID), [4-230](#)
  - Expert Agent Selection (EAS), [4-230](#), [9-79](#)
  - Extended User Administration of Redirected Calls, [4-338](#)
  - forced entry of account codes (FEAC), [4-229](#)
  - Group Paging, [4-355](#)
  - Hold, [4-230](#)
  - Hotline Service, [4-230](#)
  - Internal Automatic Answer (IAA), [4-399](#)
  - Intraflow and Interflow, [4-230](#)
  - ISDN, [7-38](#)
  - Leave Word Calling (LWC), [4-231](#)
  - Manual Originating Line Service, [4-230](#)
  - MF Signaling, [4-231](#), [4-443](#)
  - Multimedia Call Handling (MMCH), [11-68](#)
  - personal central office lines (PCOL), [4-231](#)
  - QSIG, [4-231](#)
  - QSIG Additional Network Feature—Transit Counter (ANF-TC), [12-102](#)
  - QSIG Call Forwarding (Diversion), [12-100](#)
  - QSIG Call Transfer, [12-100](#)
  - QSIG Supplementary Service - Call Completion, [12-94](#)
  - Restriction—Controlled, [4-519](#)
  - Ringback Queuing, [4-228](#)
  - Security Violation Notification (SVN), [4-537](#)
  - Send All Calls (SAC), [4-231](#)
  - Station Hunting, [4-560](#)
  - Temporary Bridged Appearance, [4-231](#)
  - Terminal Self Administration (TSA), [4-581](#)
  - Terminal Translation Initialization (TTI), [4-589](#)
  - Time of Day (TOD) Routing, [8-53](#)
  - Transfer, [4-231](#)
  - VDN of Origin Announcement (VOA), [9-149](#)
  - Wideband Switching, [7-69](#)
- security alerts, [4-227](#)
- call handling preferences, [9-34](#), [9-75](#)
- call identification displays
  - called party identification, [4-76](#), [4-628](#)
  - calling party identification, [4-76](#), [4-628](#)
- Incoming Call Identification (in-call-id) buttons, [4-288](#)
- language identifiers, [4-31](#)
- Whisper Page, [4-638](#)

- call identification tones, [12-6](#)
- Call Management System (CMS) feature, [9-58](#) to [9-59](#)
  - CMS stroke counts, [9-13](#)
  - interactions
    - Abandoned Call Search, [9-4](#)
    - Add/Remove Skills, [9-5](#)
    - Auto Available Split (AAS), [9-24](#)
    - Basic Call Management System (BCMS), [9-42](#)
    - Personal Station Access (PSA), [4-479](#)
    - QSIG Additional Network Feature Path Replacement (ANF-PR), [12-101](#)
    - Queue Status Indications, [9-111](#)
    - Reason Codes, [9-115](#)
    - Redirection on No Answer (RONA), [9-119](#)
    - Service Observing, [4-550](#)
    - Tenant Partitioning, [4-576](#)
    - Voice Response Integration (VRI), [9-156](#)
    - VuStats, [9-190](#)
    - Wideband Switching, [7-69](#)
- Call Park feature, [4-232](#) to [4-235](#)
  - Call Park buttons, [4-233](#), [6-17](#)
  - interactions
    - Abbreviated Dialing (AD), [4-234](#)
    - Administration without Hardware (AWOH), [4-42](#), [4-46](#)
    - Automatic Wakeup, [4-234](#)
    - Bridged Call Appearance, [4-118](#), [4-234](#)
    - Call Charge Information, [4-143](#)
    - Call Detail Recording (CDR), [4-217](#)
    - Call Forwarding, [4-229](#)
    - Call Vectoring, [4-234](#), [9-68](#)
    - CallVisor ASAI, [4-258](#)
    - Centralized Attendant Service (CAS), [12-8](#)
    - Code Calling Access, [4-234](#), [4-281](#)
    - Conference—Attendant, [4-234](#)
    - Conference—Terminal, [4-234](#)
    - Data Privacy, [4-234](#)
    - Data Restriction, [4-234](#)
    - DCS Alphanumeric Display for Terminals, [12-60](#)
    - deluxe paging, [4-418](#)
    - Drop buttons, [4-234](#)
    - Expert Agent Selection (EAS), [9-79](#)
    - Group Paging, [4-355](#)
    - Individual Attendant Access, [4-377](#)
    - Internal Automatic Answer (IAA), [4-399](#)
    - Loudspeaker Paging Access, [4-234](#)
    - Multimedia Call Handling (MMCH), [11-69](#), [11-86](#)
    - Music on Hold Access, [4-234](#)
    - Remote Access, [4-235](#)
    - Service Observing, [4-550](#)
    - Station Hunting, [4-560](#)
    - Terminal Self Administration (TSA), [4-581](#)
    - Terminating Extension Group (TEG), [4-592](#)
    - Voice Response Integration (VRI), [9-156](#)

- Call Pickup feature, [4-236](#) to [4-241](#)
  - call distribution algorithms, [4-237](#)
  - call pickup alerting, [4-237](#), [4-238](#), [4-239](#)
  - Call Pickup buttons, [4-236](#), [6-17](#)
  - call pickup groups, [4-236](#)
  - considerations, [4-238](#)
  - directed call pickup, [4-236](#), [4-237](#), [4-355](#), [9-79](#)
  - forms, [4-236](#), [5-256](#)
  - interactions
    - Abbreviated Dialing (AD), [4-238](#)
    - Administration without Hardware (AWOH), [4-46](#), [4-238](#)
    - Agent Call Handling, [9-19](#)
    - attendants, [4-238](#)
    - Automatic Callback (ACB), [4-102](#), [4-238](#)
    - Bridged Call Appearance, [4-118](#), [4-239](#)
    - Call Coverage, [4-163](#), [4-239](#)
    - Call Detail Recording (CDR), [4-217](#), [4-239](#)
    - Call Forwarding, [4-229](#), [4-239](#)
    - Call Waiting Termination, [4-239](#), [4-245](#)
    - CallVisor ASAI, [4-258](#), [4-259](#)
    - Conference—Terminal, [4-239](#)
    - Consult, [4-240](#)
    - DCS Alphanumeric Display for Terminals, [12-60](#)
    - deluxe paging, [4-419](#)
    - Expert Agent Selection (EAS), [4-240](#), [9-79](#)
    - Group Paging, [4-355](#)
    - Hold, [4-240](#)
    - Hotline Service, [4-240](#)
    - Individual Attendant Access, [4-377](#)
    - Intercom—Automatic, [4-240](#), [4-393](#)
    - Intercom—Dial, [4-240](#), [4-396](#)
    - Internal Automatic Answer (IAA), [4-240](#), [4-400](#)
    - ISDN, [7-38](#)
    - Malicious Call Trace (MCT), [4-240](#)
    - Manual Originating Line Service, [4-240](#)
    - Multimedia Call Handling (MMCH), [4-241](#), [11-69](#), [11-86](#)
    - Privacy—Manual Exclusion, [4-241](#), [4-488](#)
    - QSIG Supplementary Service - Call Completion, [12-94](#)
    - Redirection on No Answer (RONA), [9-125](#)
    - Ringback Queuing, [4-238](#), [4-522](#)
    - Security Violation Notification (SVN), [4-537](#)
    - Service Observing, [4-550](#)
    - Station Hunting, [4-560](#)
    - Tenant Partitioning, [4-241](#), [4-576](#)
    - Terminal Translation Initialization (TTI), [4-589](#)
    - Terminating Extension Group (TEG), [4-241](#)
    - Transfer, [4-241](#)
    - VDN of Origin Announcement (VOA), [9-149](#)
    - Voice Response Integration (VRI), [9-156](#)
    - Whisper Page, [4-638](#)
  - call progress feedback displays, [4-23](#), [4-77](#)
  - call progress tones, [4-155](#), [4-642](#), [4-643](#)

- Call Prompting feature, [9-60](#) to [9-62](#)
  - applications
    - Automated Attendant, [9-60](#)
    - caller information forwarding (CINFO) routing, [9-60](#)
    - data collection, [9-60](#)
    - data in/voice answer (DIVA) capability, [9-60](#)
    - Inbound Call Management (ICM), [9-83](#)
    - message collection option, [9-60](#)
  - interactions
    - Answer Detection, [4-53](#)
    - Authorization Codes, [9-62](#)
    - Call Forwarding, [4-230](#)
    - CallVisor ASAI, [4-258](#), [9-62](#)
    - Group Paging, [4-357](#)
    - Hold, [9-62](#)
    - Inbound Call Management (ICM), [9-62](#), [9-88](#)
    - Look Ahead Interflow (LAI), [9-102](#)
    - Transfer, [9-62](#)
    - Voice Response Integration (VRI), [9-154](#)
    - VuStats, [9-190](#)
- call purpose identifiers, [4-77](#), [4-629](#)
- call redirection criteria and conditions, [4-149](#)
- call screening (form), see ETA Call-Screening Table form
- Call Timer, [4-242](#)
- Call Timer feature, [4-242](#)
- Call Type buttons, [4-76](#)
- call type priorities, [4-86](#)
- Call Vector form, [9-207](#) to [9-208](#)
- Call Vectoring feature, [9-63](#) to [9-71](#)
  - see also Look Ahead Interflow (LAI)
- interactions
  - AAR and ARS, [9-67](#)
  - Attendant Control of Trunk Group Access, [9-66](#)
  - Attendant Recall, [9-66](#)
  - AUDIX, [9-66](#)
  - Authorization Codes, [9-67](#)
  - Automatic Callback (ACB), [9-67](#)
  - Best Service Routing (BSR), [9-55](#)
  - Block Collect Call, [4-111](#)
  - Bridged Call Appearance, [9-67](#)
  - Busy Verification of Terminals and Trunks (Verify), [9-67](#)
  - Call Coverage, [9-67](#)
  - Call Detail Recording (CDR), [4-217](#), [9-68](#)
  - Call Forwarding, [9-67](#)
  - Call Park, [4-234](#), [9-68](#)
  - Call Waiting Termination, [9-68](#)
  - CallVisor ASAI, [4-258](#)
  - Class of Restriction (COR), [9-68](#)
  - Code Calling Access, [9-68](#)
  - Conference—Attendant, [4-282](#), [9-68](#)
  - Conference—Terminal, [4-285](#), [9-68](#)
  - Data Restriction, [4-304](#), [9-68](#)
  - Demand Print, [9-66](#)
  - Facility Busy Indication, [9-69](#)
  - Facility Restriction Levels (FRL) and Traveling Class Marks (TCM), [9-69](#), [9-70](#)
  - Facility Test Calls, [9-69](#)

- Call Vectoring feature, interactions, (cont)
  - Flexible Billing, [4-346](#)
  - forced entry of account codes (FEAC), [9-69](#)
  - Individual Attendant Access, [9-69](#)
  - Integrated Directory, [9-69](#)
  - Intercept Treatment, [9-69](#)
  - Inter-PBX Attendant Service (IAS), [9-69](#)
  - Intraflow and Interflow, [9-69](#)
  - Leave Word Calling (LWC), [9-69](#)
  - MF Signaling, [4-442](#)
  - Night Service, [9-69](#)
  - Priority Calling, [4-484](#), [9-69](#)
  - Property Management System (PMS) Interface, [9-70](#)
  - QSIG Additional Network Feature Path Replacement (ANF-PR), [12-101](#)
  - Recorded Announcement, [9-70](#)
  - Redirection on No Answer (RONA), [9-70](#), [9-125](#)
  - Ringback Queuing, [9-70](#)
  - Ringing—Abbreviated and Delayed, [4-529](#)
  - Send All Calls (SAC), [9-70](#)
  - Station Hunting, [4-561](#)
  - Tenant Partitioning, [4-576](#)
  - Time of Day (TOD) Routing, [9-70](#)
  - timed after call work (ACW), [9-70](#)
  - Timed Reminder and Attendant Timers, [9-70](#)
  - Transfer, [9-70](#)
  - Trunk to Trunk Transfer, [4-612](#)
  - Wideband Switching, [7-69](#)
- Call Waiting Termination feature, [4-244](#) to [4-245](#)
  - interactions
    - Administration without Hardware (AWOH), [4-42](#)
    - Attendant Call Waiting, [4-245](#)
    - Automatic Callback (ACB), [4-101](#), [4-245](#)
    - Bridged Call Appearance, [4-120](#)
    - Busy Verification of Terminals and Trunks (Verify), [4-133](#)
    - Call Detail Recording (CDR), [4-218](#)
    - Call Pickup, [4-239](#), [4-245](#)
    - Call Vectoring, [9-68](#)
    - Consult, [4-286](#)
    - Data Privacy, [4-245](#), [4-301](#)
    - Data Restriction, [4-245](#), [4-304](#)
    - deluxe paging, [4-419](#)
    - Malicious Call Trace (MCT), [4-427](#)
    - Priority Calling, [4-484](#)
    - QSIG Supplementary Service - Call Completion, [12-93](#)
- call work codes (CWC)
  - Agent Call Handling, [9-14](#), [9-19](#)
  - forced entries, [9-14](#)
  - lights, [9-14](#)
  - Multiple Call Handling (MCH), [9-108](#)
  - Service Observing, [4-550](#)
  - VuStats, [9-190](#)
- Called name, [12-80](#)
- Caller Info buttons, [6-17](#)
- caller information forwarding (CINFO) routing
  - Call Prompting, [9-60](#)
  - ISDN, [7-38](#)

Calling Party Number Restriction

- CPN restriction precedence, [4-249](#)
- forms, [4-247](#)
- per call CPN restriction, [4-248](#)
- per line CPN restriction, [4-248](#)

Calling Party Number/Billing Number (CPN/BN) feature, [4-246](#), [9-83](#)

Calling Party Number Restriction feature, [4-247](#) to [4-249](#)

calling privilege controls, [4-77](#), [4-93](#), [8-29](#)

CALLMASTER voice terminals

- Agent Call Handling, [9-10](#), [9-14](#), [9-18](#)
- alerting options, [4-625](#)
- Automatic Incoming Call Display, [4-108](#)
- data communications, [6-227](#)
- figure, [6-146](#)
- VuStats display, [9-162](#)

CALLR-INFO buttons, [9-61](#), [4-98](#)

CallVisor ASAI feature

- capabilities, [4-254](#)
- considerations, [4-256](#)
- detailed description, [4-254](#)
- Flexible Billing, [4-346](#)
- forms, [4-252](#)
- interactions
  - AAR and ARS, [4-257](#)
  - Abbreviated Dialing (AD), [4-256](#)
  - Add/Remove Skills, [4-256](#)
  - Agent Call Handling, [9-7](#), [9-20](#)
  - announcements, [4-256](#)
  - Answer Detection, [4-53](#), [4-257](#)
  - ASAI Drop button, [4-259](#)
  - ASAI expansion port networks (EPN), [4-260](#)
  - attendants, [4-257](#)
  - Authorization Codes, [4-257](#)
  - Automated Attendant, [4-99](#)
  - Automatic Call Distribution (ACD), [4-257](#)
  - Automatic Callback (ACB), [4-257](#)
  - Bridged Call Appearance, [4-116](#), [4-257](#)
  - Call Coverage, [4-258](#), [4-259](#)
  - Call Detail Recording (CDR), [4-258](#), [4-260](#)
  - Call Forwarding, [4-230](#), [4-258](#)
  - Call Park, [4-258](#)
  - Call Pickup, [4-258](#), [4-259](#)
  - Call Prompting, [4-258](#), [9-62](#)
  - Call Vectoring, [4-258](#)
  - Class of Restriction (COR), [4-259](#)
  - Conference—Terminal, [4-259](#)
  - Data Call Setup, [4-259](#)
  - DCS Over ISDN—PRI D-Channel (DCS+), [12-64](#)
  - display change advice information, [4-259](#)
  - Distributed Communications System (DCS), [4-259](#)
  - Do Not Disturb (DND), [4-259](#)
  - Enhanced Voice Terminal Display, [4-325](#)
  - Hold, [4-260](#)
  - Hotline Service, [4-260](#)
  - Hunt Groups, [4-260](#)
  - Intraflow and Interflow, [4-260](#)

- CallVisor ASAI feature, interactions, (cont)
  - ISDN, [4-260](#)
  - ISDN–PRI facilities, [4-260](#)
  - Last Number Dialed, [4-260](#)
  - Leave Word Calling (LWC), [4-261](#)
  - Look Ahead Interflow (LAI), [4-261](#)
  - MF Signaling, [4-441](#)
  - Multimedia Call Handling (MMCH), [11-65](#)
  - multimedia endpoints, [4-261](#)
  - multiple split queuing, [4-261](#)
  - Music on Hold Access, [4-261](#)
  - Personal Station Access (PSA), [4-478](#)
  - Priority Calling, [4-261](#)
  - Privacy—Manual Exclusion, [4-261](#)
  - QSIG, [4-261](#)
  - QSIG Supplementary Service - Call Completion, [12-93](#)
  - R2 multifrequency compelled (MFC) signaling, [4-261](#)
  - Reason Codes, [9-115](#)
  - Redirection on No Answer (RONA), [4-261](#), [9-122](#)
  - Ringback Queuing, [4-262](#)
  - Russian MF shuttle signaling, [4-262](#)
  - Send All Calls (SAC), [4-262](#)
  - Service Observing, [4-262](#), [4-549](#)
  - single line voice terminals, [4-262](#)
  - Station Hunting, [4-559](#)
  - supervisor assist, [4-262](#)
  - Temporary Bridged Appearance, [4-262](#)
  - Terminating Extension Group (TEG), [4-262](#)
  - timed after call work (ACW) agent pause, [4-262](#)
  - Timed Reminder and Attendant Timers, [4-262](#)
  - Transfer, [4-259](#)
  - VDN of Origin Announcement (VOA), [9-149](#)
  - Voice Message Retrieval, [4-262](#)
  - Voice Response Integration (VRI), [9-155](#)
  - wait answer supervision timers (WAST), [4-262](#)
  - world class–BRI terminals, [4-263](#)
- language displays, [4-21](#)
- CallVisor ASAI-BRI, [4-250](#)
- CallVisor/PC, [9-81](#)
- CAMA – E911 Trunk Group form, [7-161](#)
- cancellation of authorization code requests (CACR), [4-95](#), [4-96](#)
- CCITT, [4-382](#), [4-439](#)
- CDR System Parameters form, [5-63](#) to [5-68](#)
- Centers of Excellence, [xxxvi](#)
- CenterVu CMS, [9-17](#), [9-20](#)
- central office (CO)
  - CO Line buttons, [6-23](#)
  - power failures, [4-482](#)
- Centralized Attendant Service (CAS) feature, [12-4](#) to [12-10](#)
  - backup service, [12-5](#)
  - branch generated call identification tones, [12-6](#)
  - CAS Backup buttons, [6-18](#)
  - considerations, [12-7](#)
  - forms, [5-86](#)

Centralized Attendant Service (CAS) feature, (cont)  
interactions

- AAR and ARS, [8-17](#), [12-8](#)
- Abbreviated Dialing (AD), [12-7](#)
- Attendant Auto Manual Splitting, [12-8](#)
- Attendant Control of Trunk Group Access, [12-8](#)
- Attendant Direct Extension Selection (DXS) with Busy Light Field, [4-71](#)
- Attendant Override of Diversion Features, [4-84](#), [12-8](#)
- Attendant Serial Calling, [4-91](#), [12-8](#)
- Automatic Circuit Assurance (ACA), [4-106](#)
- Busy Indicator buttons, [12-8](#)
- Call Charge Information, [4-144](#)
- Call Coverage, [4-163](#), [12-8](#)
- Call Detail Recording (CDR), [4-218](#), [12-8](#)
- Call Forwarding, [12-8](#)
- Call Park, [12-8](#)
- Class of Restriction (COR), [4-275](#)
- DCS Alphanumeric Display for Terminals, [12-60](#)
- Distributed Communications System (DCS), [12-8](#)
- DTGS buttons, [12-8](#)
- DXS buttons, [12-8](#)
- Emergency Access to Attendant, [4-320](#), [12-9](#)
- Hold—Automatic, [4-362](#)
- Hunt Groups, [12-9](#)
- Individual Attendant Access, [4-378](#)
- Inter-PBX Attendant Service (IAS), [12-73](#)
- Last Number Dialed, [4-404](#), [12-9](#)
- Leave Word Calling (LWC), [4-408](#), [12-9](#)
- Look Ahead Interflow (LAI), [9-102](#)
- Malicious Call Trace (MCT), [4-427](#)
- Night Service, [12-9](#)
- nonattendant consoles, [12-9](#)
- Security Violation Notification (SVN), [4-537](#)
- Terminal Self Administration (TSA), [4-581](#)
- Timed Reminder and Attendant Timers, [4-596](#), [12-10](#)
- Trunk-Name buttons, [12-10](#)

queues, [12-5](#)

release link trunks (RLT), [12-5](#)

remote hold, [12-5](#)

Terminal Translation Initialization (TTI), [4-588](#)

Trunk-Name buttons, [6-25](#)

Centralized Automatic Message Accounting trunk group, see CAMA – E911 Trunk Group form  
change commands, [B-3](#)

change login command, [2-10](#)

channel service units (CSU), [7-60](#)

character voice terminal displays, [4-638](#)

Check In/Check Out buttons, [6-18](#)

check in/check out status, [10-2](#), [10-3](#)

chime codes, [4-280](#)

China

#1 signaling, [4-490](#)

country codes, [6-12](#)

Public Network Call Priority, [4-489](#), [4-490](#), [4-491](#)



- circuit packs
  - TN725B, [10-34](#)
  - TN750B, [10-33](#)
  - TN750C, [10-33](#)
  - TN763D, [10-33](#)
- Circuit Packs form, [5-69](#) to [5-71](#)
  - administration commands, [5-69](#)
  - implementation notes, [5-71](#)
  - instructions, [5-70](#)
  - screen, [5-70](#)
- Class of Restriction (COR) feature, [4-264](#) to [4-276](#)
  - ACD splits, [9-35](#)
  - called party and calling party restrictions interactions
    - Night Service, [4-275](#)
    - Restriction—Controlled, [4-274](#)
    - tie trunk access, [4-275](#)
    - Transfer, [4-275](#)
  - inward restrictions, [4-265](#)
  - manual terminating line restrictions, [4-265](#)
  - origination restrictions, [4-266](#)
  - outward restrictions, [4-266](#)
  - public restrictions, [4-266](#)
  - termination restrictions, [4-266](#)
- considerations, [4-267](#)
- COR buttons, [4-77](#)
- detailed description, [4-264](#)
- display identifiers, [4-77](#)
- examples
  - AAR/ARS FRL for control of call routing, [4-271](#)
  - calling party and called party restrictions, [4-268](#)
  - miscellaneous restrictions, [4-268](#), [4-272](#)
- forms, [4-264](#)
- fully restricted service restrictions, [4-266](#)
  - interactions
    - Centralized Attendant Service (CAS), [4-275](#)
    - Distributed Communications System (DCS), [4-275](#)
    - emergency transfers, [4-275](#)
    - Hunt Groups, [4-275](#)
    - personal central office lines (PCOL), [4-275](#)
    - Remote Access, [4-276](#)
- interactions
  - AAR and ARS, [4-274](#)
  - AAR and ARS Partitioning, [4-274](#)
  - Administered Connections (AC), [4-18](#)
  - AUDIX, [4-623](#)
  - Authorization Codes, [4-96](#)
  - Automatic Callback (ACB), [4-102](#)
  - Bridged Call Appearance, [4-120](#), [4-274](#)
  - Call Coverage, [4-163](#), [4-274](#)
  - Call Forwarding, [4-274](#)
  - Call Vectoring, [9-68](#)
  - CallVisor ASAI, [4-259](#)

Class of Restriction (COR) feature, interactions, (cont)

- Conference—Terminal, [4-285](#)
- Dial Access to Attendant, [4-310](#)
- Emergency Access to Attendant, [4-274](#), [4-320](#)
- Enhanced DCS (EDCS), [12-66](#)
- Expert Agent Selection (EAS), [9-79](#)
- forced entry of account codes (FEAC), [4-274](#)
- Individual Attendant Access, [4-378](#)
- Intercom—Automatic, [4-394](#)
- Loudspeaker Paging Access, [4-274](#)
- Multimedia Call Handling (MMCH), [11-69](#), [11-87](#)
- Private Network Access, [4-274](#)
- Remote Access, [4-513](#)
- Restriction—Controlled, [4-274](#), [4-519](#)
- Station Hunting, [4-561](#)
- Voice Response Integration (VRI), [9-156](#)
- Whisper Page, [4-638](#)
- Wideband Switching, [7-69](#)

language displays, [4-23](#)

security measures, [4-621](#)

terminal and trunk restrictions, [4-267](#)

interactions

AAR and ARS, [4-276](#)

Abbreviated Dialing (AD), [4-276](#)

privileged system number lists, [4-276](#)

toll and TAC toll restrictions, [4-267](#)

Class of Restriction form, [5-72](#) to [5-80](#)

administration commands, [5-73](#)

facility assignments, [5-72](#)

implementation notes, [5-78](#)

instructions, [5-73](#)

system security, [5-72](#)

Class of Service (COS) feature, [4-277](#) to [4-279](#)

interactions, [4-279](#)

Administered Connections (AC), [4-18](#)

Expert Agent Selection (EAS), [9-79](#)

Hunt Groups, [4-279](#)

Individual Attendant Access, [4-378](#)

Multimedia Call Handling (MMCH), [11-69](#), [11-87](#)

Terminal Self Administration (TSA), [4-581](#)

Wideband Switching, [7-69](#)

security measures, [4-621](#)

Class of Service form, [5-81](#) to [5-83](#)

administration commands, [5-81](#)

instructions, [5-81](#)

clear commands, [B-4](#)

clear measurements commands

security-violations, [2-8](#)

client room COS, [4-279](#), [10-19](#)

Client Room Coverage Path Configuration, [10-31](#)

Clocked-Override buttons, [6-18](#)

CO Trunk Group form, [7-122](#), [7-168](#) to [7-173](#)

- Code Calling Access feature, [4-280](#) to [4-281](#)
  - interactions
    - Abbreviated Dialing (AD), [4-281](#)
    - Call Park, [4-234](#), [4-281](#)
    - Call Vectoring, [9-68](#)
    - Conference—Attendant, [4-281](#)
    - Conference—Terminal, [4-281](#)
    - deluxe paging, [4-419](#)
    - Loudspeaker Paging Access, [4-281](#)
    - miscellaneous trunk restrictions, [4-281](#)
    - origination restrictions, [4-281](#)
    - Restriction—Controlled, [4-281](#)
    - Transfer, [4-281](#)
- Code Calling IDs form, [5-84](#) to [5-85](#)
- coded chime signals, [4-280](#)
- collect calls (disallowed in Brazil), [4-110](#)
- combined conversion modems, [4-449](#), [4-450](#)
- Command Completion Status screen, [2-30](#)
- command line
  - abbreviations, [2-7](#)
  - case sensitivity, [2-7](#)
  - categories, [2-6](#)
  - formats, [B-1](#)
  - Help key, [2-4](#)
  - keyword entries, [2-7](#)
  - objects
    - add commands, [B-2](#)
    - change commands, [B-3](#)
    - display commands, [B-5](#)
    - duplicating commands, [B-6](#)
    - list commands, [B-7](#)
    - remove commands, [B-8](#)
    - status commands, [B-9](#)
  - programmable function keys, [2-2](#)
  - qualifiers, [B-1](#)
  - restrictions, [B-1](#)
  - structure, [2-7](#)
- Command Permission Categories form, [2-8](#), [2-12](#), [7-14](#)
- common channel signaling (CCS), [7-16](#)
- common control switching arrangements (CCSA), [7-120](#), [7-156](#), [12-75](#)
- communication interface links (form), *see* Interface Links form
- communication interface processor channels (form), *see* Processor Channel Assignment forms
- communications survey, [1-1](#)
- Conference buttons, [4-88](#), [4-233](#), [4-283](#), [4-285](#), [4-351](#)
- Conference—Attendant feature, [4-282](#)
  - interactions
    - Administration without Hardware (AWOH), [4-42](#)
    - Agent Call Handling, [9-20](#)
    - Attendant Intrusion (Call Offer), [4-83](#)
    - AUDIX, [4-622](#)
    - Bridged Call Appearance, [4-120](#), [4-282](#)
    - Busy Verification of Terminals and Trunks (Verify), [4-133](#)
    - Call Charge Information, [4-144](#)
    - Call Coverage, [4-164](#)
    - Call Detail Recording (CDR), [4-218](#)
    - Call Forwarding, [4-230](#)
    - Call Park, [4-234](#)

- Conference—Attendant feature, interactions, (cont)
  - Call Vectoring, [4-282](#), [9-68](#)
  - Code Calling Access, [4-281](#)
  - DCS Alphanumeric Display for Terminals, [12-60](#)
  - deluxe paging, [4-419](#)
  - Dial Access to Attendant, [4-310](#)
  - Flexible Billing, [4-347](#)
  - Group Paging, [4-355](#)
  - Internal Automatic Answer (IAA), [4-400](#)
  - ISDN, [7-38](#)
  - Leave Word Calling (LWC), [4-408](#)
  - Recorded Telephone Dictation Access, [4-508](#)
  - Ringback Queuing, [4-522](#)
  - Temporary Bridged Appearance, [4-567](#)
  - Transfer, [4-597](#)
  - Trunk to Trunk Transfer, [4-283](#)
  - Whisper Page, [4-638](#)
- Conference—Terminal feature, [4-284](#)
  - interactions
    - Administration without Hardware (AWOH), [4-42](#)
    - Agent Call Handling, [9-20](#)
    - Attendant Intrusion (Call Offer), [4-83](#)
    - Automatic Callback (ACB), [4-102](#)
    - Bridged Call Appearance, [4-120](#), [4-284](#)
    - Busy Verification of Terminals and Trunks (Verify), [4-133](#)
    - Call Charge Information, [4-144](#)
    - Call Coverage, [4-164](#)
    - Call Detail Recording (CDR), [4-218](#)
    - Call Forwarding, [4-230](#)
    - Call Park, [4-234](#)
    - Call Pickup, [4-239](#)
    - Call Vectoring, [4-285](#), [9-68](#)
    - CallVisor ASAI, [4-259](#)
    - Class of Restriction (COR), [4-285](#)
    - Code Calling Access, [4-281](#)
    - DCS Alphanumeric Display for Terminals, [12-60](#)
    - deluxe paging, [4-419](#)
    - Flexible Billing, [4-347](#)
    - Group Paging, [4-355](#)
    - Internal Automatic Answer (IAA), [4-400](#)
    - ISDN, [7-39](#)
    - Leave Word Calling (LWC), [4-408](#)
    - Malicious Call Trace (MCT), [4-427](#)
    - multifunction stations, [4-285](#)
    - Recorded Telephone Dictation Access, [4-508](#)
    - Ringback Queuing, [4-522](#)
    - Temporary Bridged Appearance, [4-567](#)
    - Trunk to Trunk Transfer, [4-285](#)
    - VDN of Origin Announcement (VOA), [9-149](#)
    - Voice Response Integration (VRI), [9-156](#)
    - Whisper Page, [4-638](#)
- Console Parameters form, [5-86](#) to [5-91](#)
- console permissions, [4-278](#)
- Console Status buttons, [4-613](#)
- Constellation voice/data terminals, [6-162](#)

- Consult feature, [4-286](#)
  - Consult buttons, [4-152](#), [6-18](#)
  - interactions
    - Bridged Call Appearance, [4-122](#), [4-286](#)
    - Call Coverage, [4-152](#), [4-286](#)
    - Call Pickup, [4-240](#)
    - Call Waiting Termination, [4-286](#)
    - Multimedia Call Handling (MMCH), [11-69](#), [11-86](#)
    - Priority Calling, [4-484](#)
    - Ringing—Abbreviated and Delayed, [4-528](#)
    - Temporary Bridged Appearance, [4-286](#), [4-567](#)
- Cont buttons, [12-29](#)
- Control Deactivate buttons, [4-63](#)
- Controlled Restrictions Configuration, [10-30](#)
- controlled slip seconds (CSS), [7-23](#)
- controlled trunk groups, [4-62](#)
- conventions used, [xxviii](#)
- CONVERSANT voice information system (CVIS)
  - host/adjunct call routing, [9-87](#)
  - Inbound Call Management (ICM), [9-81](#), [9-84](#)
  - Voice Response Integration (VRI), [9-152](#)
- converse commands, [4-550](#)
- converse-on vector command, [9-17](#), [9-152](#)
- converse splits, *see under* splits
- cordless voice terminals, *see* CP9530, MDC9000 and MDW9000.
- Corporate Security, [xxxvi](#)
- country codes
  - tables, [6-11](#)
- country protocol options, [6-32](#), [6-194](#), [7-43](#), [12-47](#)
- coverage (form), *see* Remote Call Coverage Table form
- Coverage Answer Group form, [5-92](#) to [5-93](#)
- coverage answer groups, [4-122](#), [4-153](#), [4-288](#), [12-62](#)
- Coverage Callback feature, [4-287](#)
  - Coverage Callback buttons, [4-153](#), [6-19](#)
  - interactions
    - Call Coverage, [4-153](#)
    - DCS Call Coverage, [12-62](#)
    - DCS Call Forwarding, [12-63](#)
- Coverage Incoming Call Identification (ICI) feature, [4-288](#)
  - Coverage ICI buttons, [4-153](#)
  - incoming call ID tones, [9-18](#)
  - Incoming Call Identification (in-call-id) buttons, [4-288](#)
  - interactions
    - Call Coverage, [4-153](#)
- coverage message retrieval
  - Covr Msg Retrieve buttons, [4-407](#), [6-19](#)
  - modes, [4-627](#)
  - permissions, [4-82](#)
- Coverage Path for Client Rooms, [10-31](#)
- Coverage Path form, [5-94](#) to [5-98](#)
- coverage paths, [10-35](#)
- coverage subsequent redirection intervals, [4-148](#)
- coverage time of day (form), *see* Time of Day Coverage Table form
- CP9530 cordless voice terminals, [6-168](#), [6-170](#)
- CPE Trunk Group form, [7-122](#), [7-174](#) to [7-177](#)
- CPN restriction precedence, [4-249](#)

Customer Provided Equipment (CPE) Alarm feature, [4-289](#)  
interactions  
Administration without Hardware (AWOH), [4-42](#)  
Terminal Translation Initialization (TTI), [4-589](#)  
customer provided equipment (CPE) forms, [7-174](#)

---

## D

D-channel backups  
Administered Connections (AC), [4-19](#)  
Facility and Nonfacility Associated Signaling (FAS and NFAS), [7-51](#)  
DCS Over ISDN-PRI D-Channel (DCS+), [12-64](#)

Data buttons, [4-42](#), [4-388](#), [6-19](#)

Data Call Setup feature, [4-290](#) to [4-297](#)  
call progress messages, [4-293](#)  
considerations, [4-296](#)  
data call preindications, [4-295](#)  
data communications protocol (DCP) modules, [4-294](#)  
data terminal dialing, [4-295](#)  
DCP and ISDN-BRI modules, [4-291](#)  
detailed description, [4-291](#)  
forms, [4-290](#)  
interactions  
Abbreviated Dialing (AD), [4-296](#)  
Administered Connections (AC), [4-18](#)  
Administration without Hardware (AWOH), [4-44](#)  
Automatic Call Distribution (ACD), [9-38](#)  
Call Coverage, [4-296](#)  
Call Detail Recording (CDR), [4-296](#)  
call forwarding—all calls, [4-296](#)  
CallVisor ASAI, [4-259](#)  
Default Dialing, [4-308](#)  
deluxe paging, [4-419](#)  
Enhanced Voice Terminal Display, [4-325](#)  
Extended Trunk Access (ETA), [12-68](#)  
Internal Automatic Answer (IAA), [4-296](#), [4-400](#)  
Modem Pooling, [4-297](#), [4-451](#)  
Multimedia Call Handling (MMCH), [11-69](#), [11-87](#)  
QSIG Additional Network Feature Path Replacement (ANF-PR), [12-101](#)  
uniform call distribution (UCD), [4-297](#)  
World Class Tone Detection (WCTD), [4-297](#)

ISDN-BRI modules, [4-295](#)  
methods, [4-290](#)  
one button transfer to data, [4-295](#)  
port assignments, [4-291](#)  
return to voice, [4-295](#)  
special characters, [4-291](#)  
voice terminal dialing, [4-294](#), [4-295](#)

data collection ports, [B-7](#)  
data communications equipment (DCE), [4-305](#), [6-228](#)  
data communications protocol (DCP) modules, [4-294](#)  
data extension buttons, [4-295](#)  
data extension calls, [4-529](#)

- Data Hotline feature, [4-298](#) to [4-300](#)
  - interactions
    - Administered Connections (AC), [4-18](#)
    - call forwarding—all calls, [4-300](#)
    - data terminal dialing, [4-300](#)
    - Multimedia Call Handling (MMCH), [11-69](#), [11-87](#)
- data in/voice answer (DIVA) capability, [9-60](#)
- data line circuit (DLC) pack option settings, [6-239](#)
- Data Line Data Module form, [6-234](#) to [6-242](#)
  - connections
    - intelligent data terminals, [6-241](#)
    - non-intelligent terminals, [6-240](#)
    - personal computers (PCs), [6-241](#)
  - DLC option settings, [6-239](#)
  - instructions, [6-234](#)
  - printer settings, [6-239](#)
  - screens, [6-235](#)
- data line data modules
  - connection to data terminals or PCs, [6-241](#)
  - forms, [6-234](#)
  - printer connection options, [6-239](#)
- Data Module forms
  - administration commands, [6-226](#)
  - field descriptions, [6-230](#)
- data modules
  - see also* specific data module types
  - 7500, [6-228](#)
  - administration, [6-225](#)
  - administration commands, [6-226](#)
  - automatic duplication, [B-6](#)
  - data line circuit (DLC) packs, [6-234](#)
  - detailed description, [6-227](#)
  - digital data endpoints, [4-449](#)
  - Manual Signaling, [4-432](#)
  - moves with TTI, [4-583](#)
  - types of, [6-226](#)
- Data Only Off Premises Extensions feature, [4-305](#)
  - interactions
    - Modem Pooling, [4-451](#)
    - voice terminal dialing, [4-306](#)
- data origination access codes, [4-450](#)
- Data Privacy feature, [4-301](#)
  - interactions
    - Attendant Call Waiting, [4-59](#), [4-301](#)
    - Attendant Intrusion (Call Offer), [4-83](#)
    - Bridged Call Appearance, [4-122](#), [4-301](#)
    - Busy Verification of Terminals and Trunks (Verify), [4-134](#), [4-301](#)
    - Call Park, [4-234](#)
    - Call Waiting Termination, [4-245](#), [4-301](#)
    - DCS Call Waiting, [12-63](#)
    - deluxe paging, [4-419](#)
    - Intercom—Automatic, [4-302](#), [4-394](#)
    - Intercom—Dial, [4-302](#), [4-396](#)
    - Modem Pooling, [4-451](#)
    - Music on Hold Access, [4-302](#), [4-456](#)
    - Priority Calling, [4-302](#)
    - QSIG Additional Network Feature Path Replacement (ANF-PR), [12-102](#)
    - Whisper Page, [4-638](#)

- data protection, [6-224](#)
- Data Restriction feature, [4-303](#)
  - interactions
    - Attendant Call Waiting, [4-59](#), [4-304](#)
    - Attendant Intrusion (Call Offer), [4-83](#)
    - Automatic Call Distribution (ACD), [9-38](#)
    - Bridged Call Appearance, [4-122](#)
    - Busy Verification of Terminals and Trunks (Verify), [4-134](#), [4-304](#)
    - Call Park, [4-234](#)
    - Call Vectoring, [4-304](#), [9-68](#)
    - Call Waiting Termination, [4-245](#), [4-304](#)
    - DCS Call Waiting, [12-63](#)
    - Digital Multiplexed Interface (DMI), [7-19](#), [7-20](#)
    - Intercom—Automatic, [4-304](#), [4-394](#)
    - Intercom—Dial, [4-304](#), [4-396](#)
    - Modem Pooling, [4-451](#)
    - Music on Hold Access, [4-304](#), [4-456](#)
    - Priority Calling, [4-304](#)
    - QSIG Additional Network Feature Path Replacement (ANF-PR), [12-102](#)
    - Service Observing, [4-304](#)
    - VDN of Origin Announcement (VOA), [9-150](#)
- data screen delivery, [9-84](#)
- data service units (DSU), [6-228](#), [7-60](#)
- data terminal dialing, [4-294](#), [4-300](#), [4-642](#)
  - Administration without Hardware (AWOH), [4-47](#)
  - Alphanumeric Dialing, [4-49](#)
  - Data Call Setup, [4-49](#), [4-295](#)
  - Data Only Off Premises Extensions, [4-305](#)
  - Default Dialing, [4-307](#)
  - EIA Interface, [6-219](#)
- data terminal equipment (DTE), [6-228](#)
- data terminal speed settings, [2-16](#)
- DATAPHONE digital service, [4-305](#)
- DATAPHONE II switched network modems, [4-450](#)
- date and time
  - attendant display modes, [4-75](#)
  - Call Detail Recording (CDR), [2-17](#), [4-213](#)
  - display buttons, [6-19](#)
  - language display modes, [4-23](#)
  - modes, [4-627](#)
  - screens, [2-17](#)
  - settings, [2-17](#)
- day language displays, [4-24](#)
- DCS Alphanumeric Display for Terminals feature, [12-27](#), [12-56](#)
  - interactions
    - Attendant Call Waiting, [12-60](#)
    - Automatic Callback (ACB), [12-60](#)
    - Call Coverage, [12-60](#)
    - Call Forwarding, [12-60](#)
    - Call Park, [12-60](#)
    - Call Pickup, [12-60](#)
    - Centralized Attendant Service (CAS), [12-60](#)
    - conference, [12-60](#)
    - direct department calling (DDC), [12-60](#)
    - internal terminal to terminal calling, [12-60](#)
    - ISDN-PRI, [12-61](#)
    - uniform call distribution (UCD), [12-60](#)



- DCS Attendant Control of Trunk Group Access feature, [12-28](#), [12-56](#)
  - interactions
    - DCS Attendant Display, [12-61](#)
    - DCS Automatic Callback (ACB), [12-61](#)
    - Uniform Dial Plan (UDP), [12-61](#)
- DCS Attendant Direct Trunk Group Selection feature, [12-29](#), [12-57](#)
- DCS Attendant Display feature, [12-31](#), [12-57](#)
  - interactions, [12-61](#)
    - DCS Attendant Control of Trunk Group Access, [12-61](#)
    - Inter-PBX Attendant Service (IAS), [12-72](#)
- DCS Automatic Callback (ACB) feature, [12-32](#), [12-57](#)
  - interactions
    - Attendant Control of Trunk Group Access, [12-61](#)
    - Call Forwarding, [12-61](#)
    - DCS Attendant Control of Trunk Group Access, [12-61](#)
    - DCS Call Forwarding, [12-61](#)
    - vector directory numbers (VDN), [12-61](#)
- DCS Automatic Circuit Assurance (ACA) feature, [12-34](#)
- DCS Busy Verification of Terminals and Trunks feature, [12-35](#), [12-57](#)
  - interactions
    - routing patterns, [12-62](#)
    - Trunk Identification by Attendant, [12-61](#)
- DCS Call Coverage feature, [12-36](#) to [12-40](#), [12-58](#)
  - applications, [12-37](#)
  - AUDIX, [12-38](#)
  - configuration example, [12-37](#)
  - interactions
    - Call Coverage off premises, [12-62](#)
    - coverage answer groups, [12-62](#)
    - Coverage Callback, [12-62](#)
    - displays, [12-62](#)
    - Go to Cover, [12-62](#)
    - Leave Word Calling (LWC), [12-62](#)
    - queuing, [12-63](#)
  - operation, [12-38](#)
  - operation under error conditions, [12-40](#)
  - operation under normal conditions, [12-39](#)
- DCS Call Forwarding feature, [12-41](#), [12-58](#)
  - interactions
    - Coverage Callback, [12-63](#)
    - DCS Automatic Callback (ACB), [12-61](#)
    - DCS Leave Word Calling (LWC), [12-64](#)
    - DCS nodes, [12-63](#)
    - Leave Word Calling (LWC), [12-63](#)
- DCS Call Waiting feature, [12-42](#)
  - interactions
    - Automatic Callback (ACB), [12-63](#)
    - Data Privacy, [12-63](#)
    - Data Restriction, [12-63](#)
    - Enhanced DCS (EDCS), [12-63](#)

- DCS Distinctive Ringing feature, [12-43](#), [12-58](#)
  - interactions
    - Distinctive Ringing, [12-63](#)
    - Intercom—Automatic, [12-64](#)
    - Intercom—Dial, [12-64](#)
    - Manual Signaling, [12-64](#)
    - tie trunk access, [12-63](#)
  - ringing patterns, [12-43](#)
- DCS Leave Word Calling (LWC) feature, [12-44](#), [12-58](#)
  - interactions
    - AUDIX, [4-623](#)
    - DCS Call Forwarding, [12-64](#)
    - DCS Multiappearance Conference/Transfer, [12-64](#)
- DCS Multiappearance Conference/Transfer feature, [12-46](#), [12-58](#)
  - interactions
    - DCS Leave Word Calling (LWC), [12-64](#)
    - Enhanced DCS (EDCS), [12-64](#)
    - Voice Terminal Display, [12-64](#)
- DCS Over ISDN—PRI D-Channel (DCS+) feature, [12-47](#) to [12-49](#)
  - call associated—temporary signaling connections (CA—TSC), [12-48](#)
  - considerations, [12-59](#)
  - gateway nodes, [12-49](#)
  - interactions
    - Attendant Direct Extension Selection (DXS) with Busy Light Field, [12-64](#)
    - Call Detail Recording (CDR), [12-64](#)
    - CallVisor ASAI, [12-64](#)
    - D-channel backup, [12-64](#)
    - DCS AUDIX, [12-65](#)
    - Generalized Route Selection (GRS), [12-65](#)
    - ISDN—PRI, [12-65](#)
    - software defined networks (SDN), [12-65](#)
    - voice terminals, [12-65](#)
  - noncall associated—temporary signaling connections (NCA—TSC), [12-48](#)
  - signaling methods, [12-47](#)
- DCS Trunk Group Busy/Warning Indication feature, [12-52](#), [12-59](#)
  - interactions
    - Loudspeaker Paging Access, [12-66](#)
- DCS trunk turnarounds, [4-600](#), [4-601](#)
- DCS with Rerouting feature, [12-50](#)
  - considerations, [12-50](#)
  - description, [12-50](#)
  - forms, [12-50](#)
  - interactions, [12-51](#)
- DEC VT220, [2-2](#)
- Default Announcement Extension, [10-34](#)
- default codes, [9-114](#)
- Default Coverage Path for Client Rooms, [10-31](#)
- Default Dialing feature, [4-307](#)
- default feature buttons, [5-44](#)
- DEFINITY documentation, list of, [C-1](#)
- DEFINITY Helpline, [xxxvi](#)
- DEFINITY LAN Gateway, [4-250](#)
- delayed ringing, [4-526](#)
- Delete buttons, [4-75](#), [4-628](#)
- Delete-Message buttons, [6-19](#)
- delta channels (D-channels or data channels), [4-382](#)

- Demand Print feature, [4-309](#)
  - interactions
    - Call Vectoring, [9-66](#)
    - Station Security Codes (SSC), [4-565](#)
- diacritical marks, [5-193](#)
- Dial Access to Attendant feature, [4-310](#)
  - interactions
    - Inter-PBX Attendant Service (IAS), [12-73](#)
    - Multimedia Call Handling (MMCH), [11-69](#)
    - Priority Calling, [4-484](#)
    - Tenant Partitioning, [4-576](#)
- dial ahead digits, [9-154](#)
- Dial buttons, [11-68](#)
- dial codes, [5-3](#), [5-6](#), [5-10](#), [5-13](#), [5-16](#)
- Dial Plan feature, [4-311](#) to [4-313](#)
  - forms, [4-311](#), [5-99](#)
  - interactions
    - ISDN-BRI, [4-313](#)
    - MF Signaling, [4-313](#)
    - Uniform Dial Plan (UDP), [4-312](#), [12-108](#)
  - permissible codes/allowable number digits, [4-311](#)
- Dial Plan Record form, [5-99](#) to [5-103](#)
- dial plans
  - establishing, [1-7](#)
  - hotel/motel services and room numbers, [4-553](#)
- dialed number identification service (DNIS), [4-41](#), [4-551](#), [9-36](#)
- dictation equipment, [4-508](#)
- DID Trunk Group form, [7-122](#), [7-178](#) to [7-182](#)
- Digit Absorption form, [7-91](#) to [7-92](#), [7-122](#)
- digit analysis, [8-8](#)
- digit conversion, [8-9](#)
- Digit to Insert/Delete, [10-35](#)
- digital communications protocol (DCP)
  - data module formats, [4-449](#)
  - ISDN-BRI, [4-382](#)
  - off premises terminals, [4-467](#)
  - PC Interface configurations, [6-220](#)
- digital data endpoints, [4-301](#), [4-303](#), [4-305](#)
- digital display voice terminals, *see under* voice terminals
- Digital Multiplexed Interface (DMI) feature, [7-19](#)
  - interactions
    - Administered Connections (AC), [4-18](#)
    - Data Restriction, [7-19](#), [7-20](#)
    - Modem Pooling, [4-451](#), [7-20](#)
    - Multimedia Call Handling (MMCH), [11-69](#)
- digital multiplexed interfaces (DMI)
  - DMI-BOS protocols, [7-188](#)
  - DS1 tie trunks, [7-120](#)
- digital public network trunks, [7-121](#)
- digital terminal data modules (DTDM), [6-91](#), [6-234](#)
- digital terminal equipment (DTE), [4-305](#)
- digital tie trunks, [7-120](#)
- Digits from PMS, [10-34](#)
- Digits in PMS Coverage Path, [10-35](#)

- DIOD Trunk Group form, [7-183](#) to [7-187](#)
  - administration, [7-184](#)
  - field descriptions, [7-122](#)
  - hardware requirements, [7-183](#)
  - implementation notes, [7-185](#)
  - screens, [7-184](#)
- Dir buttons, [4-142](#)
- direct agent calling (DAC)
  - Automatic Call Distribution (ACD), [9-33](#)
  - call handling preferences, [9-34](#)
  - CallVisor, [4-257](#)
  - Expert Agent Selection (EAS), [9-77](#)
  - Inbound Call Management (ICM), [9-83](#), [9-87](#), [9-88](#)
  - Multiple Call Handling (MCH), [9-108](#)
  - Reason Codes, [9-115](#)
  - Redirection on No Answer (RONA), [9-126](#)
  - RONA routing sequences, [9-118](#)
  - Service Observing, [4-551](#)
  - VDN of Origin Announcement (VOA), [9-150](#)
  - via logical agent ID, [4-639](#)
- direct department calling (DDC)
  - Attendant Call Waiting, [4-59](#)
  - Automatic Call Distribution (ACD), [9-28](#)
  - busy verification, [4-132](#)
  - Call Coverage, [4-164](#)
  - DCS Alphanumeric Display for Terminals, [12-60](#)
  - Internal Automatic Answer (IAA), [4-400](#)
  - QSIG Supplementary Service - Call Completion, [12-95](#)
  - Redirection on No Answer (RONA), [9-126](#)
  - Send All Calls (SAC), [4-538](#)
  - Terminal Translation Initialization (TTI), [4-589](#)
  - Terminating Extension Group (TEG), [4-592](#)
  - test calls, [4-130](#)
  - Voice Response Integration (VRI), [9-157](#)
  - Whisper Page, [4-639](#)
- direct extension selection
  - DXS buttons, [4-54](#), [4-68](#), [12-8](#)
  - DXS tracking, [4-68](#)
- direct inward dialing (DID)
  - Call Forwarding, [4-230](#)
  - DID-LDN night extensions, [4-461](#)
  - DID no answer timers, [4-442](#)
  - Group Paging, [4-355](#)
  - Listed Directory Numbers form, [5-207](#)
  - trunk groups, [12-108](#)
- direct inward dialing, see DIDTrunk Group form, [7-178](#)
- direct inward/outward dialing, see DIODTrunk Group form, [7-183](#)
- Direct Trunk Group Selection Status buttons, [4-613](#)
- disassociated stations, [4-40](#)
- disconnects, forced, [9-31](#)
- disp-chrg buttons, [4-142](#)
- display commands, [2-18](#), [B-5](#)
- display login command, [2-11](#)
- display messages (form), see Language Translations forms
- Display Room Information in Call Display, [10-34](#)
- Display Status buttons, [4-613](#)
- displays
  - change advice information, [4-259](#)
  - modes, [4-74](#)
  - RONA calling/called number displays, [9-125](#)

- Distinctive Ringing feature, [4-314](#) to [4-316](#)
  - default ringing cycles, [4-314](#)
  - defaults for country code 1, [4-314](#)
  - interactions
    - DCS Distinctive Ringing, [12-63](#)
    - Off Premises Station, [4-468](#)
    - Personalized Ringing, [4-316](#), [4-481](#)
    - Ringer Cutoff, [4-524](#)
    - Ringing—Abbreviated and Delayed, [4-529](#)
    - Voice Terminal Alerting Options, [4-625](#)
  - nonadministrable cycles at attendant console for country code 1, [4-315](#)
  - nonadministrable signals, [4-315](#)
- Distributed Communications System (DCS) feature, [12-11](#) to [12-26](#)
  - see also* specific DCS features
  - 2-Node private network with AUDIX, [12-16](#)
  - 3-Node public/private network with AUDIX, [12-20](#)
  - administration for switch 1, [12-17](#), [12-22](#)
  - administration for switch 2, [12-19](#), [12-24](#)
  - administration for switch 3, [12-25](#)
  - AUDIX administration, [12-17](#), [12-22](#)
  - AUDIX configuration examples, [12-16](#)
  - AUDIX/DCS gateway, [12-15](#)
  - configuring DCS networks, [12-11](#)
  - DCS features, [12-15](#)
  - detailed description, [12-14](#)
  - feature considerations, [12-56](#)
  - forms, [5-179](#), [12-12](#), [12-13](#)
  - interactions, [12-26](#)
    - AAR and ARS Partitioning, [8-22](#)
    - Attendant Serial Calling, [4-91](#)
    - Automatic Call Distribution (ACD), [9-38](#)
    - Automatic Callback (ACB), [4-102](#)
    - Automatic Circuit Assurance (ACA), [4-106](#)
    - Block Collect Call, [4-111](#)
    - Call Charge Information, [4-144](#)
    - Call Detail Recording (CDR), [4-219](#)
    - CallVisor ASAI, [4-259](#)
    - Centralized Attendant Service (CAS), [12-8](#)
    - Class of Restriction (COR), [4-275](#)
    - Enhanced Voice Terminal Display, [4-326](#)
    - Extended User Administration of Redirected Calls, [4-338](#)
    - Extension Number Portability (ENP), [12-71](#)
    - Group Paging, [4-355](#)
    - Hold—Automatic, [4-362](#)
    - Integrated Directory, [4-381](#)
    - Internal Automatic Answer (IAA), [4-400](#)
    - ISDN, [7-39](#)
    - Look Ahead Routing (LAR), [8-47](#)
    - Malicious Call Trace (MCT), [4-427](#)
    - MF Signaling, [4-442](#)
    - Priority Calling, [4-485](#)
    - QSIG Call Forwarding (Diversion), [12-100](#)
    - QSIG Call Transfer, [12-101](#)
    - QSIG Name and Number Identification, [12-101](#)
    - Security Violation Notification (SVN), [4-537](#)
    - Service Observing, [4-550](#)

- Distributed Communications System (DCS) feature, interactions, (cont)
  - Station Hunting, [4-561](#)
  - Time of Day (TOD) Routing, [8-53](#)
  - Uniform Dial Plan (UDP), [12-108](#)
  - Voice Response Integration (VRI), [9-157](#)
  - Whisper Page, [4-639](#)
  - network configurations, [12-14](#)
- diversion features
  - Attendant Override of Diversion Features, [4-84](#)
  - Call Coverage, [4-146](#)
  - Call Forwarding, [4-224](#)
  - Send All Calls (SAC), [4-538](#)
- DMI-BOS Trunk Group form
  - field descriptions, [7-122](#)
  - implementation notes, [7-189](#)
  - screens, [7-189](#)
- Do Not Disturb (DND) feature, [10-11](#) to [10-13](#)
  - activation by
    - attendants, [10-12](#)
    - Property Management System (PMS) Interface, [10-12](#)
    - voice terminal users, [10-12](#)
  - audit trail reports, [10-13](#)
  - considerations, [10-13](#)
  - daily reports, [10-13](#)
  - detailed description, [10-11](#)
  - Do Not Disturb buttons, [6-20](#), [10-12](#)
  - Do Not Disturb Ext buttons, [6-20](#)
  - Do Not Disturb Grp buttons, [6-20](#)
  - Do Not Disturb Plus COR Status report, [10-13](#)
  - Do Not Disturb Status report, [10-13](#)
  - forms, [10-11](#)
  - interactions
    - Automatic Callback (ACB), [10-13](#)
    - Automatic Wakeup, [10-10](#), [10-13](#)
    - Call Coverage, [10-13](#)
    - call forwarding—all calls, [10-13](#)
    - CallVisor ASAI, [4-259](#)
    - Internal Automatic Answer (IAA), [4-400](#), [10-14](#)
    - PC Console, [10-14](#)
    - Property Management System (PMS) Interface, [10-14](#), [10-28](#)
    - Restriction—Controlled, [10-14](#)
    - Ringling—Abbreviated and Delayed, [4-529](#)
    - Whisper Page, [4-639](#)
  - language displays, [4-25](#)
  - speech synthesizer boards, [10-12](#)
- Do Not Disturb Plus COR Status report, [10-13](#)
- Do Not Disturb Status report, [10-13](#)
- documentation, related, [C-1](#)
- Drop buttons, [4-234](#), [4-259](#), [6-20](#)
- DS1 alarm buttons, [6-20](#)
- DS1 Circuit Pack form, [7-79](#) to [7-90](#)
  - administration commands, [5-186](#), [7-79](#)
  - field descriptions, [7-79](#)
- DS1 Trunk Service feature, [7-11](#) to [7-18](#)
  - alternate voice data (AVD) signaling, [7-16](#)
  - Command Permission Categories form, [7-14](#)
  - common channel signaling (CCS), [7-16](#)
  - detailed description, [7-12](#)

DS1 Trunk Service feature, (cont)  
  DS1 field implementation guidelines, [7-14](#)  
  DS1 operational and signaling parameters, [7-13](#)  
  enhanced DS1 administration, [7-14](#)  
  forms, [7-11](#)  
  interactions  
    Modem Pooling, [4-451](#)  
  ISDN signaling requirements, [7-16](#)  
  public network signaling administration, [7-17](#)  
  signaling modes, [7-16](#)  
DS1FD voice terminals, [6-47](#)  
DS1SA voice terminals, [6-47](#)  
DTGS buttons, [12-8](#)  
Dual DCP I-Channels feature, [4-317](#)  
dual tone multifrequency (DTMF) receivers, [4-343](#)  
Dual Wakeup, [10-32](#)  
duplex system backup, [2-33](#)  
duplicate command, [1-7](#)  
duplicate data-module command, [1-8](#)  
Duplication-Related System Parameters form, [5-104](#) to [5-105](#)

---

## E

EIA 232C data terminal equipment (DTE) interfaces, [4-386](#), [6-218](#), [6-228](#), [6-243](#)  
EIA Interface feature, [6-218](#) to [6-219](#)  
  interactions  
    data terminal dialing, [6-219](#)  
elapsed time display modes, [4-75](#), [4-639](#)  
electronic tandem networks (ETN)  
  Block Collect Call, [4-111](#)  
  Call Charge Information, [4-144](#)  
  Inter-PBX Attendant Service (IAS), [12-73](#)  
  ISDN, [7-30](#)  
  Private Network Access, [12-75](#)  
  Whisper Page, [4-639](#)  
Emergency Access Calls report, [4-67](#)  
Emergency Access to Attendant feature, [4-318](#) to [4-321](#)  
  considerations, [4-425](#)  
  emergency call audit records, [4-319](#)  
  interactions  
    Administration without Hardware (AWOH), [4-44](#)  
    Call Detail Recording (CDR), [4-219](#)  
    Centralized Attendant Service (CAS), [4-320](#), [12-9](#)  
    Class of Restriction (COR), [4-274](#), [4-320](#)  
    Individual Attendant Access, [4-320](#)  
    Intercept Treatment, [4-320](#)  
    Inter-PBX Attendant Service (IAS), [4-321](#)  
    Malicious Call Trace (MCT), [4-427](#)  
    Night Service, [4-321](#)  
    priority queues, [4-321](#)  
    Remote Access, [4-321](#)  
    Restriction—Controlled, [4-321](#)  
    Tenant Partitioning, [4-576](#)  
  language displays, [4-30](#)  
  off hook alerts, [4-278](#)  
emergency calls, [4-66](#), [4-84](#)

- emergency transfers, [4-275](#)
- end user survey, [1-4](#)
- endpoint software applications, [7-58](#), [11-34](#)
- enhanced call transfers (ECT), [3-2](#), [4-621](#)
- Enhanced DCS (EDCS) feature, [12-55](#), [12-59](#)
  - interactions
    - Class of Restriction (COR), [12-66](#)
    - DCS Call Waiting, [12-63](#)
    - DCS Multiappearance Conference/Transfer, [12-64](#)
- enhanced direct extension selection (DXS) tracking, [4-68](#), [4-70](#)
- enhanced multimedia complex, [11-31](#)
- enhanced number lists, [4-4](#), [4-5](#)
- enhanced private switched communications service (EPSCS), [7-120](#), [7-156](#), [12-75](#)
- enhanced terminal administration (ETA), [6-5](#)
- Enhanced Voice Terminal Display feature, [4-322](#) to [4-332](#)
  - activation tasks, [4-322](#)
  - considerations, [4-323](#)
  - directory, [4-325](#)
  - external feature interactions
    - AUDIX, [4-326](#)
    - AUDIX Voice Power/Audix Voice Power Lodging, [4-326](#)
    - CallVisor ASAI, [4-325](#)
    - Distributed Communications System (DCS), [4-326](#)
    - Look Ahead Interflow (LAI), [4-326](#)
    - Monitor 1 and OneVision, [4-326](#)
    - Novell Telephony Services, [4-326](#)
    - Passageway Direct Connect, [4-326](#)
    - QSIG, [4-326](#)
    - VuStats, [4-326](#)
- forms, [4-322](#)
- forms that accept enhanced display characters, [4-331](#)
- group 1 to group 2a character maps, [4-327](#)
- group 1 to group 2b character maps, [4-329](#)
- interactions
  - AUDIX, [4-326](#)
  - Call Charge Information, [4-144](#)
- internal feature interactions
  - Data Call Setup, [4-325](#)
  - ISDN, [4-325](#)
  - Leave Word Calling (LWC), [4-325](#)
  - OSSI, [4-325](#)
  - Voice Message Retrieval, [4-325](#)
  - Voice Terminal Display, [4-325](#)
- Katakana characters, [4-323](#)
- trouble shooting, [4-324](#)
- enhancements (to existing features), [A-1](#)
- errors
  - Administered Connections (AC), [4-16](#)
  - codes, [2-25](#)
  - DCS Call Coverage error conditions, [12-40](#)
  - extended superframe format (ESF) CRC-6, [7-23](#)
  - list of codes and descriptions, [2-36](#)
  - memory card related failures, [2-21](#)
  - messages, [2-25](#)
  - Multimedia Applications Server Interface (MASI), [11-29](#)
- ETA Call Screening Table form, [5-106](#) to [5-107](#), [12-113](#)



ETSI protocols

- NET 3 protocol, [6-194](#)
- supplementary service protocols, [12-78](#)

European characters, [4-322](#)

European WCBRI protocols, [6-194](#)

Exclusion buttons, [6-20](#)

expansion interface (EI) circuit boards, [4-260](#)

expansion port networks (EPN)

- CallVisor, [4-260](#)

Expert Agent Selection (EAS) feature, [9-72](#) to [9-80](#)

- agent administration, [9-75](#)
- agent login IDs, [9-76](#), [9-77](#)
- call distribution, [9-75](#)
- call distribution methods, [9-75](#)
- call handling preference, [9-75](#)
- considerations, [9-77](#)
- direct agent announcement (DAA)
  - capabilities, [9-73](#)
  - forms, [9-74](#)

direct agent calling (DAC), [9-77](#)

expert agent distribution (EAD), [9-75](#)

forms, [9-72](#), [9-120](#)

interactions

- Abbreviated Dialing (AD), [9-78](#)
- Add/Remove Skills, [9-5](#), [9-78](#)
- Administration without Hardware (AWOH), [9-78](#)
- Agent Call Handling, [9-20](#)
- AUDIX, [9-78](#)
- Auto Available Split (AAS), [9-78](#)
- automatic answering, [9-79](#)
- Best Service Routing (BSR), [9-56](#)
- Call Detail Recording (CDR), [4-219](#)
- Call Forwarding, [4-230](#), [9-79](#)
- Call Park, [9-79](#)
- Call Pickup, [4-240](#), [9-79](#)
- Class of Restriction (COR), [9-79](#)
- Class of Service (COS), [9-79](#)
- directed call pickup, [9-79](#)
- Leave Word Calling (LWC), [4-408](#), [9-80](#)
- Look Ahead Interflow (LAI), [9-80](#)
- message waiting lights, [9-80](#)
- MF Signaling, [4-443](#)
- Queue Status Indications, [9-80](#)
- Ringling—Abbreviated and Delayed, [4-529](#)
- Service Observing, [9-80](#)
- supervisor assist, [9-78](#)
- Terminal Translation Initialization (TTI), [4-589](#)
- VDN of Origin Announcement (VOA), [9-150](#)
- Voice Response Integration (VRI), [9-157](#)
- Voice Terminal Display, [9-79](#)
- VuStats, [9-80](#)
- work modes, [9-78](#)

Multiple Call Handling (MCH), [9-104](#)

personal calls, [9-78](#)

routing, [9-75](#)

uniform call distribution (UCD), [9-75](#)

vector administration, [9-74](#)

Vector Directory Number (VDN) administration, [9-74](#)

- Expert Agent Selection—preference handling distribution (EAS-PHD)
  - Add/Remove Skills, [9-6](#)
  - VuStats, [9-190](#)
- extended superframe format (ESF) CRC-6 errors, [7-23](#)
- Extended Trunk Access (ETA) feature, [12-67](#) to [12-69](#)
  - cautions, [12-67](#)
  - forms, [5-106](#), [12-67](#)
  - interactions
    - Abbreviated Dialing (AD), [12-68](#)
    - attendant calls, [12-68](#)
    - Data Call Setup, [12-68](#)
    - Facility Restriction Levels (FRL) and Traveling Class Marks (TCM), [12-69](#)
    - Last Number Dialed, [12-69](#)
    - Modem Pooling, [12-69](#)
    - Remote Access, [12-69](#)
- Extended User Administration of Redirected Calls feature, [4-333](#) to [4-338](#)
  - changing Call Coverage or activating Call Forwarding from on-site locations, [4-335](#)
  - Class of Restriction (COR), [4-334](#)
  - Class of Service (COS), [4-334](#)
  - considerations, [4-338](#)
  - deactivating Call Forwarding from on-site locations, [4-336](#)
  - detailed description, [4-333](#)
  - end user procedures, [4-334](#)
  - forms, [4-333](#)
  - interactions
    - Administration without Hardware (AWOH), [4-338](#)
    - Bridged Call Appearance, [4-338](#)
    - Call Coverage, [4-157](#), [4-338](#)
    - Call Forwarding, [4-338](#)
    - Distributed Communications System (DCS), [4-338](#)
    - Security Violation Notification (SVN), [4-339](#)
    - Station Security Codes (SSC), [4-565](#)
    - Tenant Partitioning, [4-339](#)
  - interrupting the command sequence, [4-337](#)
  - security alerts, [4-337](#)
  - telecommuting access extensions, [4-334](#)
  - using attendants or console-permissions stations, [4-336](#)
  - using FAC from off site locations, [4-337](#)
- extension buttons, [6-14](#), [6-17](#)
- Extension Number Portability (ENP) feature, [12-70](#) to [12-71](#)
  - ENP codes, [12-70](#)
  - ENP numbering plans, [12-70](#)
  - interactions
    - Distributed Communications System (DCS), [12-71](#)
    - Station Hunting, [4-561](#)
    - Uniform Dial Plan (UDP), [12-108](#)
- Extension Number Portability Numbering Plan form, [12-115](#)
- Extension of Journal/Schedule Printer, [10-31](#)
- Extension of PMS, [10-31](#)
- Extension of PMS Log Printer, [10-31](#)
- Extension to Receive Failed Wakeup LWC Messages, [10-34](#)
- extensions
  - status tracking, [4-68](#)
- Extensions Administered to have an MCT-Control Button form, [5-108](#)
- External Device Alarm Port form, [5-109](#) to [5-112](#)
- External Device Alarming feature, [4-340](#)

---

## F

- Facility and Nonfacility Associated Signaling (FAS and NFAS) feature, [7-49](#) to [7-55](#)
  - D-channel backup activation, [7-51](#)
  - D-channel backup with NFAS, [7-49](#)
  - D-channel failures, [7-51](#)
  - DS1 interface configuration for NFAS, [7-52](#)
  - form, [7-49](#)
  - guidelines for administering FAS and NFAS, [7-51](#)
  - interactions, [7-55](#)
    - Administered Connections (AC), [4-19](#)
    - Wideband Switching, [7-69](#)
  - ISDN–PRI interface on R5vs/si, [7-54](#)
  - system technician commands, [7-51](#)
- Facility Busy Indication feature, [4-341](#)
  - Facility Busy Indication buttons, [4-341](#)
  - interactions
    - Administration without Hardware (AWOH), [4-42](#)
    - Bridged Call Appearance, [4-122](#)
    - Call Vectoring, [9-69](#)
    - Individual Attendant Access, [4-378](#)
    - Terminal Self Administration (TSA), [4-581](#)
    - Wideband Switching, [7-69](#)
- Facility Restriction Levels (FRL) and Traveling Class Marks (TCM) features, [8-24](#) to [8-28](#)
  - call originating facilities, [8-25](#)
  - call-terminating facilities, [8-26](#)
  - considerations, [8-26](#)
  - forms, [8-24](#)
  - guidelines, [8-27](#)
  - interactions
    - AAR and ARS, [8-28](#)
    - Alternate Facility Restriction Levels (AFRL), [8-32](#)
    - Authorization Codes, [4-96](#), [8-28](#)
    - Call Detail Recording (CDR), [8-28](#)
    - Call Vectoring, [9-69](#), [9-70](#)
    - Extended Trunk Access (ETA), [12-69](#)
    - Intercept Treatment, [8-28](#)
    - ISDN, [7-39](#)
    - Look Ahead Interflow (LAI), [9-102](#)
    - QSIG Call Forwarding (Diversion), [12-100](#)
    - security measures, [4-621](#)
- Facility Test Calls feature, [4-343](#)
  - interactions
    - Administered Connections (AC), [4-19](#)
    - Call Vectoring, [9-69](#)
    - Voice Messaging Systems, [4-623](#)
    - Wideband Switching, [7-69](#)
  - test types, [4-343](#)
- failed seconds (FS), [7-23](#)

failures

- Administered Connections (AC), [4-16](#)
- central office (CO) power, [4-482](#)
- D-channels, [7-51](#)
- Multimedia Applications Server Interface (MASI), [11-29](#)
- network failures, [7-61](#)
- power, [4-461](#), [4-482](#)
- primary transmission paths, [7-61](#)
- voice response units (VRU), [9-117](#)

fast retries, [4-17](#)

Feature Access Code (FAC) form, [5-113](#) to [5-122](#)

- administration commands, [5-113](#)
- instructions, [5-113](#)
- screens and implementation notes, [5-114](#)

feature access codes (FAC)

- agent login, [9-9](#)
- changing, [1-7](#)
- Malicious Call Trace (MCT), [4-426](#)
- skill changes, [9-5](#)

Feature-Related System Parameters form, [5-123](#) to ??

- administration commands, [5-123](#)
- instructions, [5-123](#)

feature transparency, [12-77](#)

Feature-Related System Parameters form, [5-145](#), [9-206](#)

features

- administration, [1-3](#)
- default buttons., [5-44](#)
- feature button characteristics, [5-48](#)
- feature button displays, [4-135](#)
- optional, [1-3](#)
- security precautions, [3-3](#)
- system, [1-7](#)
- transition reference, [A-1](#)

Fiber Link Administration form, [5-146](#) to [5-157](#)

- administration commands, [5-146](#)
- instructions
  - basic fiber link administration, [5-148](#)
  - DS1 converter boards, [5-155](#), [5-156](#), [5-157](#)
  - DS1C converter boards, [5-150](#), [5-154](#)
  - duplicated fiber link administration, [5-149](#)
- PNC duplication, [5-147](#)
- simplex PNC, [5-147](#)

first announcements, [9-29](#)

Flash buttons, [4-603](#), [4-605](#), [6-20](#)

Flexible Billing feature, [4-345](#) to [4-347](#)

- interactions
  - Call Detail Recording (CDR), [4-346](#)
  - Call Vectoring, [4-346](#)
  - Conference—Attendant, [4-347](#)
  - Conference—Terminal, [4-347](#)
  - Transfer, [4-347](#)

- rates, [4-345](#)

flexible language displays, [4-639](#)

forced disconnects, [9-31](#)

forced first announcements, [4-465](#), [9-30](#)

forced password aging, [2-11](#)

Forced Release buttons, [4-84](#), [4-376](#)

foreign exchange (FX) trunk group administration, [7-193](#)

Forward PMS Message to INTUITY Lodging, [10-31](#)

## France

- Administrable Language Displays, [4-20](#)
- country codes, [6-12](#)
- Language Translations, [5-193](#)
- Leave Word Calling (LWC), [4-405](#)
- Misoperation Handling, [4-445](#)
- PC Console, [4-470](#)
- Voice Terminal Display, [4-626](#)

FTC Alarm buttons, [6-25](#)

## function keys

- modules, [6-101](#), [6-223](#)
- programmable, [2-2](#)
- system administration terminals (SAT), [2-5](#)

FX Trunk Group form, [7-193](#) to [7-196](#)

---

## G

gateway nodes, [12-49](#)

Generalized Route Selection (GRS) feature, [8-33](#) to [8-44](#)

- BCC and ITC determination on calls from endpoints to ISDN-PRI trunks, [8-42](#)
- ISDN trunks to endpoints (GRS not involved), [8-44](#)
- trunks to ISDN-PRI, [8-43](#)

BCC determination at tandeming or terminating system, [8-38](#)

BCC examples, [8-39](#)

bearer capability classes (BCC), [8-34](#)

detailed description, [8-33](#)

digital communications protocols (DCP), [8-38](#)

digital multiplexed interface (DMI) modes, [8-38](#)

forms, [8-33](#), [8-67](#)

information transfer capabilities (ITC), [8-37](#)

## interactions

- Administered Connections (AC), [4-18](#)
- Call by Call (CBC) Service Selection feature, [7-48](#)
- DCS Over ISDN-PRI D-Channel (DCS+), [12-65](#)
- Look Ahead Routing (LAR), [8-47](#)
- Wideband Switching, [7-70](#)

ISDN BCC Parameters, [8-37](#)

ISDN-PRI routing parameters, [8-34](#)

ITC codepoints, [8-40](#)

ITC encoding setup message, [8-41](#)

look ahead algorithms, [8-39](#)

low layer compatibility information elements (LLC IE), [8-38](#)

## Germany

country codes, [6-12](#)

PC Console, [4-470](#)

glare, [7-66](#), [7-219](#)

Go to Cover feature, [4-348](#)

Go To Cover buttons, [4-348](#), [4-622](#), [6-20](#)

## interactions

- DCS Call Coverage, [12-62](#)
- Group Paging, [4-355](#)
- Internal Automatic Answer (IAA), [4-400](#)
- Whisper Page, [4-639](#)

group 4 fax applications, [6-228](#)

Group Display buttons, [4-69](#), [4-70](#)

- group forms, [1-4](#)
  - Group Listen feature, [4-349](#) to [4-351](#)
    - interactions
      - Whisper Page, [4-639](#)
    - security alert, [4-351](#)
  - Group Member Assignments form, [7-147](#)
    - implementation notes, [7-267](#)
    - screens, [7-155](#), [7-160](#), [7-173](#), [7-177](#), [7-182](#), [7-187](#), [7-192](#), [7-197](#), [7-218](#), [7-245](#), [7-256](#), [7-261](#), [7-267](#), [7-272](#)
  - group number lists, [4-3](#), [4-5](#), [4-9](#)
  - Group Paging feature, [4-352](#) to [4-357](#)
    - GrpPg buttons, [6-20](#)
    - interactions
      - Attendant Intrusion (Call Offer), [4-354](#)
      - Automatic Callback (ACB), [4-354](#)
      - Bridged Call Appearance, [4-355](#)
      - Call Coverage, [4-355](#)
      - Call Forwarding, [4-355](#)
      - Call Park, [4-355](#)
      - Call Pickup, [4-355](#)
      - Call Prompting, [4-357](#)
      - Conference—Attendant, [4-355](#)
      - Conference—Terminal, [4-355](#)
      - direct inward dialing (DID), [4-355](#)
      - directed call pickup, [4-355](#)
      - Distributed Communications System (DCS), [4-355](#)
      - Go to Cover, [4-355](#)
      - Hold, [4-356](#)
      - Hold—Automatic, [4-354](#)
      - Leave Word Calling (LWC), [4-356](#)
      - Manual Signaling, [4-356](#)
      - Privacy—Attendant Lockout, [4-354](#)
      - Privacy—Manual Exclusion, [4-354](#)
      - Send All Calls (SAC), [4-356](#)
      - Service Observing, [4-356](#)
      - Tenant Partitioning, [4-356](#)
      - Transfer, [4-356](#)
      - trunk groups, [4-356](#)
      - Whisper Page, [4-639](#)
    - security considerations, [4-354](#)
  - Group Select buttons, [4-68](#)
  - GuestWorks, [10-27](#)
- 

## H

- H.320 calls, [11-30](#)
- H0 channels, [7-64](#)
- H11 channels, [7-63](#)
- H12 channels, [7-64](#)
- hands free answering, [4-397](#)
- hardware components
  - CPE alarms, [4-289](#)
- Hayes command set, [6-229](#)

- headsets, [4-581](#)
  - Agent Call Handling, [9-18](#)
  - automatic answering, [9-18](#)
- held call timed reminders, [4-362](#)
- Help key
  - command line, [2-4](#)
  - status commands, [B-9](#)
  - system administration terminals (SAT), [2-4](#)
- high priority messages, [4-128](#)
- high speed links (HSL), [6-228](#)
- Historical Split report, [9-119](#)
- History report
  - system security, [3-2](#)
- Hold feature, [4-358](#) to [4-360](#)
  - considerations, [4-360](#)
  - forms, [4-358](#)
  - hard hold, [4-359](#)
- Hold buttons, [4-358](#)
- interactions
  - Administration without Hardware (AWOH), [4-46](#)
  - Automated Attendant, [4-99](#)
  - Automatic Call Distribution (ACD), [9-38](#)
  - Automatic Callback (ACB), [4-102](#), [4-360](#)
  - Bridged Call Appearance, [4-360](#)
  - Busy Verification of Terminals and Trunks (Verify), [4-134](#)
  - Call Charge Information, [4-144](#)
  - Call Coverage, [4-164](#)
  - Call Forwarding, [4-230](#)
  - Call Pickup, [4-240](#)
  - Call Prompting, [9-62](#)
  - CallVisor ASAI, [4-260](#)
  - deluxe paging, [4-420](#)
  - Group Paging, [4-356](#)
  - Hold—Automatic, [4-362](#)
  - ISDN, [7-39](#)
  - Leave Word Calling (LWC), [4-360](#)
  - Multimedia Call Handling (MMCH), [11-69](#)
  - Music on Hold Access, [4-360](#)
  - personal central office lines (PCOL), [4-360](#)
  - Priority Calling, [4-360](#)
  - QSIG Supplementary Service - Call Completion, [12-94](#)
  - Service Observing, [4-551](#)
  - Trunk Identification by Attendant, [4-610](#)
  - VDN of Origin Announcement (VOA), [9-150](#)
  - Voice Response Integration (VRI), [9-157](#)
- Hold Time parameters, [4-450](#)
- Hold—Automatic feature, [4-361](#) to [4-362](#)
  - interactions
    - Bridged Call Appearance, [4-123](#)
    - Centralized Attendant Service (CAS), [4-362](#)
    - Distributed Communications System (DCS), [4-362](#)
    - Group Paging, [4-354](#)
    - Hold, [4-362](#)
    - Multiple Call Handling (MCH), [9-108](#)
    - Voice Response Integration (VRI), [9-157](#)

- Hop Channel Assignment form
  - administration commands, [12-116](#)
  - assignments between switches, [12-118](#)
  - instructions, [12-117](#)
  - screen, [12-116](#)
- Hospitality features
  - Attendant Room Status, [10-2](#)
  - Automatic Wakeup, [10-4](#)
  - Do Not Disturb (DND), [10-11](#)
  - Hospitality Services, [10-15](#)
  - Names Registration, [10-17](#)
  - Property Management System (PMS) Interface, [10-21](#)
- Hospitality form, [10-30](#) to [10-37](#)
  - administration commands, [10-30](#)
  - implementation notes, [10-35](#)
  - instructions, [10-30](#)
  - screens, [10-36](#)
- Hospitality Services feature, [10-15](#)
  - interactions
    - Attendant Display, [4-82](#)
- host computer access, [6-224](#)
- host routing, [9-87](#)
- Hotline Service feature, [4-363](#) to [4-364](#)
  - interactions
    - Abbreviated Dialing (AD), [4-12](#)
    - Automatic Callback (ACB), [4-102](#)
    - Bridged Call Appearance, [4-123](#), [4-364](#)
    - Call Detail Recording (CDR), [4-219](#)
    - Call Forwarding, [4-230](#)
    - Call Pickup, [4-240](#)
    - CallVisor ASAI, [4-260](#)
    - Loudspeaker Paging Access, [4-364](#)
    - Manual Originating Line Service, [4-431](#)
    - QSIG Supplementary Service - Call Completion, [12-94](#)
    - Ringback Queuing, [4-364](#)
- housekeeper
  - configuration, [10-31](#)
- Hundreds Select buttons, [4-54](#), [4-68](#), [5-47](#)
- Hunt Group form, [5-158](#) to [5-174](#)
  - administration commands, [5-159](#)
  - implementation notes, [5-160](#)
  - instructions, [5-159](#)
- Hunt Groups feature, [4-365](#) to [4-372](#)
  - ACD splits, [9-25](#)
  - ADU-type hunt groups, [4-290](#)
  - analog announcements, [4-368](#)
  - announcements, [4-367](#)
  - aux-trunk announcements, [4-368](#)
  - call coverage, [4-367](#)
  - considerations, [4-370](#)
  - delay announcement intervals, [4-367](#)
  - detailed description, [4-366](#)
  - example, [4-368](#)
  - forms, [4-365](#)
  - how extensions become unavailable, [4-368](#)
  - hunt group busy options, [4-369](#)
  - Hunt Group buttons, [6-21](#)
  - hunt group queues, [4-366](#)



Hunt Groups feature, (cont)

hunting methods, [4-366](#)

integrated announcements, [4-368](#)

interactions

Administered Connections (AC), [4-19](#)

Administration without Hardware (AWOH), [4-44](#), [4-46](#), [4-48](#)

Attendant Call Waiting, [4-371](#)

attendant return calls, [4-371](#)

Automatic Callback (ACB), [4-371](#)

Bridged Call Appearance, [4-123](#)

Call Detail Recording (CDR), [4-219](#), [4-371](#)

CallVisor ASAI, [4-260](#)

Centralized Attendant Service (CAS), [12-9](#)

Class of Restriction (COR), [4-275](#)

Class of Service (COS), [4-279](#)

deluxe paging, [4-420](#)

hunt group night service, [4-372](#)

Individual Attendant Access, [4-378](#)

Internal Automatic Answer (IAA), [4-371](#)

ISDN, [7-39](#)

Leave Word Calling (LWC), [4-371](#)

MF Signaling, [4-443](#)

Multimedia Call Handling (MMCH), [11-69](#)

Music on Hold Access, [4-456](#)

Priority Calling, [4-372](#)

Station Hunting, [4-561](#)

Terminal Translation Initialization (TTI), [4-589](#)

Terminating Extension Group (TEG), [4-372](#)

VDN of Origin Announcement (VOA), [9-150](#)

Voice Response Integration (VRI), [9-157](#)

Whisper Page, [4-639](#)

queue warning levels, [4-367](#)

Send All Calls, [4-369](#)

trunk signaling, [4-370](#)

hybrid voice terminals, *see* 7313H (BIS-10), 7314H (BIS-22), 7315H (BIS-22D), 7316

---

## I

ICLID, *see* Incoming Call Line Identification on Analog Trunks

idle appearance preferences, [4-452](#)

Immediate Override buttons, [6-22](#)

Inbound Call Management (ICM) feature, [9-81](#) to [9-88](#)

adjuncts, [9-81](#), [9-87](#)

applications

adjunct applications, [9-83](#)

agent data screen delivery, [9-84](#)

Call Prompting, [9-83](#)

Calling Party Number/Billing Number (CPN/BN), [9-83](#)

direct agent calling (DAC), [9-83](#)

voice response units (VRU), [9-83](#)

configurations, [9-84](#), [9-86](#)

considerations, [9-87](#)

CONVERSANT voice information system (CVIS), [9-81](#)

displays, [9-81](#)

- Inbound Call Management (ICM) feature, (cont)
  - forms, [9-82](#)
  - host applications, [9-81](#)
  - host routing, [9-87](#)
  - integration with speech delivery, [9-85](#)
  - interactions
    - Automated Attendant, [4-99](#)
    - Call Prompting, [9-62](#), [9-88](#)
    - direct agent calling (DAC), [9-88](#)
    - Look Ahead Interflow (LAI), [9-102](#)
    - Priority Calling, [9-88](#)
    - Redirection on No Answer (RONA), [9-126](#)
- Incoming Call Line Identification on Analog Trunks feature, [4-373](#) to [4-375](#)
  - detailed description, [4-374](#)
  - forms, [4-373](#)
  - hardware requirement, [4-374](#)
  - interactions
    - Attendant Display Features, [4-374](#)
    - Automatic Display of Incoming Call Identification, [4-374](#)
    - Bridged Call, [4-374](#)
    - Call Coverage, [4-375](#)
    - Call Forwarding, [4-374](#)
    - Call Pickup, [4-375](#)
    - Call Vector Routing, [4-375](#)
    - DCS Feature Interaction, [4-375](#)
    - Hold, [4-375](#)
    - Malicious Call Trace, [4-375](#)
    - Tandem Operations, [4-375](#)
    - Transfer, [4-375](#)
- incoming disconnect supervision, [4-601](#)
- India, [4-444](#)
- Individual Attendant Access feature, [4-376](#) to [4-378](#)
  - interactions
    - Abbreviated Dialing (AD), [4-377](#)
    - Attendant Display, [4-377](#)
    - Attendant Priority Queue, [4-377](#)
    - Attendant Recall, [4-88](#)
    - Automatic Call Distribution (ACD), [9-38](#)
    - Bridged Call Appearance, [4-377](#)
    - Busy Verification of Terminals and Trunks (Verify), [4-134](#), [4-377](#)
    - Call Coverage, [4-377](#)
    - Call Park, [4-377](#)
    - Call Pickup, [4-377](#)
    - Call Vectoring, [9-69](#)
    - Centralized Attendant Service (CAS), [4-378](#)
    - Class of Restriction (COR), [4-378](#)
    - Class of Service (COS), [4-378](#)
    - Emergency Access to Attendant, [4-320](#)
    - Facility Busy Indication, [4-378](#)
    - Hunt Groups, [4-378](#)
    - Integrated Directory, [4-378](#)
    - Leave Word Calling (LWC), [4-378](#)
    - Malicious Call Trace (MCT), [4-427](#)
    - night console service, [4-378](#)
    - Privacy—Attendant Lockout, [4-378](#), [4-486](#)
    - Time of Day (TOD) Routing, [8-53](#)
    - Voice Terminal Display, [4-378](#)

- information elements (IE), [7-45](#)
- Information Forwarding feature, [9-89](#) to [9-94](#)
  - Administering UUI Transport, [9-90](#)
  - Determining User Information Needs, [9-92](#)
- interactions
  - Best Service Routing, [9-89](#)
  - Shared UUI Administration, [9-91](#)
  - Support of New Features, [9-90](#)
  - Testing, [9-93](#)
  - Troubleshooting, [9-93](#)
  - UUI Transport, [9-89](#)
- information indicator digits (II-digits), [7-39](#)
- information transfer capabilities (ITC), [8-34](#), [8-37](#), [8-72](#)
- Initialization and Administration System (INADS), [4-51](#)
- inspect display modes, [4-75](#), [4-613](#), [4-626](#)
- Inspect Mode buttons, [6-21](#)
- integrated announcement board (form), *see* Announcements/Audio Sources form
- Integrated Announcement Extension, [10-34](#)
- Integrated Channel Service Unit (ICSU) feature, [7-21](#) to [7-24](#)
  - performance measurements, [7-23](#)
  - testing, [7-22](#)
- integrated conversion modems, [4-449](#), [4-450](#)
- Integrated Directory feature, [4-379](#) to [4-381](#)
  - activating the directory, [4-380](#)
  - display modes, [4-75](#), [4-627](#)
  - Integrated Directory buttons, [4-380](#)
  - Integrtd Directory buttons, [6-19](#)
- interactions
  - Attendant Display, [4-381](#)
  - Call Vectoring, [9-69](#)
  - Distributed Communications System (DCS), [4-381](#)
  - Individual Attendant Access, [4-378](#)
  - Merlin/System 25 voice terminals, [4-381](#)
  - Service Observing, [4-550](#)
  - touch tone dialing, [4-381](#)
  - Voice Terminal Display, [4-381](#)
  - VuStats, [9-190](#)
- language displays, [4-27](#)
- Inter-Exchange Carrier Codes form, [5-177](#) to [5-178](#)
- Inter-PBX Attendant Service (IAS) feature, [12-72](#)
  - form, [5-86](#)
- interactions
  - Attendant Control of Trunk Group Access, [12-72](#)
  - Attendant Display, [12-72](#)
  - Attendant Recall, [12-73](#)
  - Call Coverage, [12-73](#)
  - Call Detail Recording (CDR), [4-220](#)
  - Centralized Attendant Service (CAS), [12-73](#)
  - DCS Attendant Display, [12-72](#)
  - Dial Access to Attendant, [12-73](#)
  - electronic tandem networks (ETN), [12-73](#)
  - Emergency Access to Attendant, [4-321](#)
  - Night Service, [12-73](#)
  - Call Vectoring, [9-69](#)
- interactions
  - Call Timer, [4-242](#)
- intercept tones, [10-11](#)

- Intercept Treatment feature, [4-390](#) to [4-392](#)
  - attendants, [4-391](#)
  - interactions
    - Call Detail Recording (CDR), [4-219](#)
    - Call Vectoring, [9-69](#)
    - Emergency Access to Attendant, [4-320](#)
    - Facility Restriction Levels (FRL) and Traveling Class Marks (TCM), [8-28](#)
    - Line Lockout, [4-409](#)
    - MF Signaling, [4-392](#)
    - Multimedia Call Handling (MMCH), [11-71](#)
    - Recorded Announcement, [4-392](#)
    - Tenant Partitioning, [4-576](#)
  - multifrequency compelled (MFC) signaling, [4-390](#)
  - recorded announcements, [4-391](#)
  - siren type tones, [4-390](#)
  - stations, [4-391](#)
- Intercom Group form, [5-175](#) to [5-176](#)
- Intercom—Automatic feature, [4-393](#)
  - Auto-(name or ext #) buttons, [6-16](#)
  - Automatic Intercom buttons, [4-393](#)
  - forms, [4-393](#), [5-175](#)
  - interactions
    - Administration without Hardware (AWOH), [4-46](#)
    - Automatic Callback (ACB), [4-102](#)
    - Bridged Call Appearance, [4-124](#)
    - call appearances, [4-393](#)
    - Call Coverage, [4-162](#), [4-393](#)
    - Call Detail Recording (CDR), [4-220](#)
    - Call Pickup, [4-240](#), [4-393](#)
    - Class of Restriction (COR), [4-394](#)
    - Data Privacy, [4-302](#), [4-394](#)
    - Data Restriction, [4-304](#), [4-394](#)
    - DCS Distinctive Ringing, [12-64](#)
    - Intercom—Dial, [4-394](#), [4-396](#)
    - Ringer Cutoff, [4-524](#)
    - Single Digit Dialing and Mixed Station Numbering, [4-394](#)
    - Station Hunting, [4-561](#)
- Intercom—Dial feature, [4-395](#)
  - Dial-Icom buttons, [6-19](#)
  - forms, [4-395](#), [5-175](#)
  - interactions
    - Administration without Hardware (AWOH), [4-46](#)
    - Automatic Call Distribution (ACD), [9-38](#)
    - Automatic Callback (ACB), [4-102](#)
    - Bridged Call Appearance, [4-124](#)
    - call appearances, [4-395](#)
    - Call Coverage, [4-162](#), [4-396](#)
    - Call Detail Recording (CDR), [4-220](#)
    - Call Pickup, [4-240](#), [4-396](#)
    - Data Privacy, [4-302](#), [4-396](#)
    - Data Restriction, [4-304](#), [4-396](#)
    - DCS Distinctive Ringing, [12-64](#)
    - Intercom—Automatic, [4-394](#), [4-396](#)
    - Ringer Cutoff, [4-524](#)
    - Single Digit Dialing and Mixed Station Numbering, [4-396](#)
    - Station Hunting, [4-561](#)
- Intercom buttons, [4-395](#)

- interdigit timeout, [8-8](#)
- Inter-Exchange Carrier Codes form, [5-177](#)
- inter exchange carriers (IXC), [8-34](#), [8-71](#)
- Interface Links form, [5-179](#) to [5-182](#)
  - administration commands, [5-179](#)
  - instructions, [5-179](#)
- Internal Automatic Answer (IAA) feature, [4-397](#) to [4-400](#)
  - IAA feature buttons, [4-398](#)
  - IntAutoAns buttons, [6-21](#)
  - interactions
    - Attendant Console, [4-398](#)
    - automatic answering, [4-398](#)
    - Automatic Call Distribution (ACD), [4-398](#), [9-38](#)
    - Automatic Callback (ACB), [4-102](#), [4-399](#)
    - Automatic Circuit Assurance (ACA), [4-106](#), [4-399](#)
    - Bridged Call Appearance, [4-124](#), [4-399](#)
    - Call Coverage, [4-164](#), [4-399](#)
    - Call Forwarding, [4-399](#)
    - Call Park, [4-399](#)
    - Call Pickup, [4-240](#), [4-400](#)
    - Conference, [4-400](#)
    - Data Call Setup, [4-296](#), [4-400](#)
    - direct department calling (DDC), [4-400](#)
    - Distributed Communications System (DCS), [4-400](#)
    - Do Not Disturb (DND), [4-400](#), [10-14](#)
    - Go to Cover, [4-400](#)
    - Hunt Groups, [4-371](#)
    - ISDN-BRI, [4-400](#)
    - Loudspeaker Paging Access, [4-400](#)
    - QSIG Supplementary Service - Call Completion, [12-94](#)
    - Ringback Queuing, [4-400](#), [4-522](#)
    - Send All Calls (SAC), [4-400](#), [4-538](#)
    - Terminating Extension Group (TEG), [4-400](#), [4-592](#)
    - Transfer, [4-400](#), [4-597](#)
    - uniform call distribution (UCD), [4-400](#)
- international BRI platform, [6-194](#)
- International Operator Access feature, [4-401](#)
- International Organization for Standardization (ISO)
  - 7-layer Open Systems Interconnect (OSI) Reference Model, [4-382](#)
  - ISDN-PRI private networking specifications, [12-77](#)
  - QSIG signaling protocols, [12-79](#)
- Inter-PBX Attendant Service (IAS) feature
  - interactions
    - Call Vectoring, [9-69](#)
- interposition calling (attendant to attendant), [4-44](#)
- interservers, [11-3](#)
- interworking, [4-388](#)
- Intraflow and Interflow features, [9-95](#) to [9-97](#)
  - ACD call redirection options, [9-95](#)
  - interactions
    - Automatic Call Distribution (ACD), [9-38](#)
    - Call Coverage, [9-97](#)
    - Call Forwarding, [4-230](#)
    - Call Vectoring, [9-69](#)
    - CallVisor ASAI, [4-260](#)
    - Temporary Bridged Appearance, [9-97](#)

- Intra-Switch CDR form, [5-183](#) to [5-185](#)
- Intuity AUDIX, [4-618](#)
- inward restriction, [4-464](#), [4-465](#)
- inward wide area telecommunications service (INWATS), [7-43](#)
- ISDN
  - interactions
    - Malicious Call Trace (MCT), [4-423](#)
- ISDN feature, [7-25](#) to [7-41](#)
  - administrable protocols, [7-27](#)
  - AT&T Switched Network Protocols, [7-28](#)
  - AT&T Switched Network Services, [7-28](#)
  - Call by Call (CBC) Service Selection, [7-31](#)
  - call identification displays, [7-29](#), [7-34](#), [7-35](#)
  - CPN/BN-to-host call identification, [7-29](#)
  - DCS services, [7-31](#)
  - detailed description, [7-27](#)
  - electronic tandem networks (ETN) services, [7-30](#)
  - feature administration, [7-26](#)
  - forms, [5-179](#), [7-25](#)
  - hardware, [7-34](#)
  - identification numbers, [7-34](#)
  - interactions
    - AAR and ARS Overlap Sending, [7-40](#)
    - Attendant Display, [7-38](#)
    - Bridged Call Appearance, [7-38](#)
    - Call Detail Recording (CDR), [4-220](#)
    - Call Forwarding, [7-38](#)
    - Call Pickup, [7-38](#)
    - caller information forwarding (CINFO) routing, [7-38](#)
    - CallVisor ASAI, [4-260](#)
    - Conference—Attendant, [7-38](#)
    - Conference—Terminal, [7-39](#)
    - Distributed Communications System (DCS), [7-39](#)
    - Enhanced Voice Terminal Display, [4-325](#)
    - Facility Restriction Levels (FRL) and Traveling Class Marks (TCM), [7-39](#)
    - Hold, [7-39](#)
    - Hunt Groups, [7-39](#)
    - information indicator digits (II-digits), [7-39](#)
    - Look Ahead Interflow (LAI), [7-39](#)
    - Look Ahead Routing (LAR), [7-40](#)
    - Malicious Call Trace (MCT), [7-40](#)
    - Terminating Extension Group (TEG), [7-40](#)
    - Transfer, [7-40](#)
    - Voice Response Integration (VRI), [9-157](#)
    - Voice Terminal Display, [7-40](#)
- ISDN gateway, [7-29](#)
- ISDN-PRI
  - basic calls, [7-36](#)
  - interworking, [7-32](#)
  - redirected calls, [7-37](#)
  - supported interfaces, [7-25](#)
- language displays, [4-27](#)
- private network configurations, [7-27](#)
- private network services, [7-30](#)
- public network configurations, [7-28](#)
- QSIG services, [7-31](#)
- software defined data networks (SDDN), [7-31](#)

ISDN feature, (cont)

Switched Digital International (SDI), [7-31](#)

types of information, [7-35](#)

Wideband Switching, [7-31](#)

ISDN Numbering—Private Format form, [7-93](#)

ISDN Numbering—Public/Unknown Format form, [7-95](#) to [7-96](#), [7-122](#)

ISDN Private Networking Specification (IPNS) forum, [12-79](#)

ISDN TELESEER, [4-181](#)

ISDN TSC Gateway Channel Assignment form, [7-98](#) to [7-99](#), [7-122](#)

ISDN-BRI feature

Malicious Call Trace (MCT) notifications, [4-423](#)

ISDN-BRI feature, [4-382](#) to [4-389](#)

Administered Connections (AC), [4-387](#)

basic digit dialing, [4-386](#)

call requests, [4-387](#)

considerations, [4-387](#)

data hotline, [4-386](#)

data service, [4-386](#)

default dialing, [4-386](#)

detailed description, [4-383](#)

endpoint initialization, [4-386](#)

equipment line location (ELL), [4-386](#)

exchange of user information, [4-386](#)

forms, [4-383](#)

interactions

AAR and ARS, [8-18](#)

busy tone forward disconnect (BTFD), [4-388](#)

Data buttons, [4-388](#)

Dial Plan, [4-313](#)

Internal Automatic Answer (IAA), [4-400](#)

interworking, [4-388](#)

Modem Pooling, [4-388](#)

Multisappearance Preselection and Preference, [4-389](#), [4-454](#)

Personal Computer (PC) Interface, [6-224](#)

Pull Transfer, [4-496](#)

Transfer, [4-597](#)

Voice Terminal Display, [4-389](#)

Wideband Switching, [7-70](#)

multipoint configurations on BRI ports, [4-383](#), [4-386](#)

point to point configurations, [4-384](#)

security measures, [4-386](#)

service profile identifiers (SPID), [4-384](#)

terminal equipment identifiers (TEI), [4-384](#)

voice/data terminal equipment, [4-385](#)

ISDN-BRI protocol, [6-220](#)

ISDN-BRI Trunk Circuit Pack form, [5-186](#) to [5-192](#)

administration commands, [5-186](#)

instructions, [5-186](#)

interactions, [5-192](#)

trunk member administration, [5-191](#)

ISDN-BRI Trunk Group form, [7-198](#), [7-198](#) to [7-218](#)

administration commands, [7-198](#)

field descriptions, [7-201](#), [7-202](#)

hardware requirements, [7-198](#)

implementation notes, [7-208](#), [7-211](#), [7-215](#)

screens, [7-202](#)

ISDN-BRI voice terminals, *see* 7505D, 7506D, 7507D, 8503D, 8510T and 8520T

## ISDN-PRI

- access codes, [8-45](#)
- interactions
  - CallVisor ASAI, [4-260](#)
  - DCS Alphanumeric Display for Terminals, [12-61](#)
  - DCS Over ISDN-PRI D-Channel (DCS+), [12-65](#)
  - Malicious Call Trace (MCT), [4-427](#)
  - Multimedia Call Handling (MMCH), [11-71](#), [11-87](#)
  - QSIG Additional Network Feature-Transit Counter (ANF-TC), [12-102](#)
  - Remote Access, [4-514](#)
- overlap sending, [8-20](#)

## ISDN-PRI feature

- Malicious Call Trace (MCT) notifications, [4-423](#)

## ISDN-PRI Trunk Group form, [7-219](#) to [7-245](#)

- administration commands, [7-150](#), [7-156](#), [7-161](#), [7-168](#), [7-174](#), [7-178](#), [7-183](#), [7-188](#), [7-193](#), [7-198](#), [7-219](#), [7-246](#), [7-257](#), [7-262](#), [7-268](#), [8-67](#)

- design considerations, [7-225](#)

- field descriptions, [7-122](#), [7-208](#), [7-226](#), [7-233](#)

### forms

- R5r system, [7-200](#), [7-222](#)
- TN765 processor interface (PI) for R5si, [7-220](#)
- TN778 packet control (PACCON) for a R5si and R5r, [7-221](#)
- TN778 packet-control (PACCON) for a R5si and R5r, [7-199](#)

- hardware requirements, [7-198](#), [7-219](#)

- implementation notes, [7-232](#), [7-236](#)

- predefined services and features, [7-205](#), [7-229](#)

- screens, [7-202](#), [7-208](#), [7-225](#), [7-233](#)

## Italy

- Administrable Language Displays, [4-20](#)
- Attendant Intrusion (Call Offer), [4-83](#)
- country codes, [6-11](#)
- Enhanced DCS (EDCS), [12-55](#)
- Language Translations, [5-193](#)
- Leave Word Calling (LWC), [4-405](#)
- Misoperation Handling, [4-445](#)
- traslatore giunzione uscente/entrante/interno (TGU/TGE/TGI) trunks, [4-83](#), [7-178](#), [12-75](#)
- Trunk Flash, [4-603](#), [4-604](#)
- Visually Impaired Attendant Service (VIAS), [4-613](#)
- Voice Terminal Display, [4-626](#)

## ITU-T access protocols, [12-79](#)

---

## J

### Japan

- country codes, [6-11](#)
  - ISDN-PRI DS1-T1 layers, [7-27](#)
  - World Class Core-BRI(WCBRI), [6-194](#)
- 

## K

- K2500 voice terminals, [6-47](#)

- Katakana characters, [4-322](#), [4-323](#)

- keywords, [2-4](#)



---

## L

- LAN interconnect applications, [6-228](#)
- Language Translations form, [5-193](#) to [5-206](#)
- languages
  - displays, [6-92](#), [6-130](#)
  - flexible language displays, [4-639](#)
  - user customized, [5-193](#)
  - voice terminal messages, [4-20](#)
- last appearance preferences, [4-452](#)
- Last Number Dialed feature, [4-403](#)
  - interactions
    - Abbreviated Dialing (AD), [4-12](#), [4-403](#)
    - Automatic Callback (ACB), [4-404](#)
    - Bridged Call Appearance, [4-124](#), [4-404](#)
    - Call Charge Information, [4-144](#)
    - Call Detail Recording (CDR), [4-220](#)
    - CallVisor ASAI, [4-260](#)
    - Centralized Attendant Service (CAS), [4-404](#), [12-9](#)
    - Extended Trunk Access (ETA), [12-69](#)
    - Priority Calling, [4-485](#)
    - Voice Terminal Display, [4-632](#)
    - Whisper Page, [4-640](#)
  - LastNumb Dialed buttons, [6-21](#)
- Last Operation buttons, [4-613](#)
- Last Voiced Message buttons, [4-613](#)
- Latin American Spanish on PC Console, [4-470](#)
- Leave Word Calling (LWC) feature, [4-405](#) to [4-408](#)
  - canceling messages, [4-407](#)
  - considerations, [4-407](#)
  - forms, [4-405](#), [5-198](#)
  - interactions
    - Administration without Hardware (AWOH), [4-43](#)
    - AUDIX, [4-408](#), [4-623](#)
    - Bridged Call Appearance, [4-124](#), [4-408](#)
    - Call Coverage, [4-164](#), [4-408](#)
    - Call Forwarding, [4-231](#)
    - Call Vectoring, [9-69](#)
    - CallVisor ASAI, [4-261](#)
    - Centralized Attendant Service (CAS), [4-408](#), [12-9](#)
    - Conference, [4-408](#)
    - DCS Call Coverage, [12-62](#)
    - DCS Call Forwarding, [12-63](#)
    - deluxe paging, [4-420](#)
    - Enhanced Voice Terminal Display, [4-325](#)
    - Expert Agent Selection (EAS), [4-408](#), [9-80](#)
    - Group Paging, [4-356](#)
    - Hold, [4-360](#)
    - Hunt Groups, [4-371](#)
    - Individual Attendant Access, [4-378](#)
    - MERLIN/System 25 voice terminals, [4-408](#)
    - Property Management System (PMS) Interface, [10-28](#)
    - Service Observing, [4-551](#)
    - Station Hunting, [4-561](#)

- Leave Word Calling (LWC) feature, interactions, (cont)
  - Station Security Codes (SSC), [4-565](#)
  - Terminating Extension Group (TEG), [4-592](#)
  - vector directory numbers (VDN), [4-408](#)
  - Voice Message Retrieval, [4-617](#)
- language displays, [4-28](#)
- Leave Word Calling buttons, [4-153](#)
- lock functions, [4-407](#)
- LWC buttons, [6-21](#)
- message storing, [4-406](#)
- standard messages, [4-406](#)
- Length of Time to Remain Connected to Announcement, [10-34](#)
- light audits, [12-52](#)
- Line Lockout feature, [4-409](#)
- line side (T1 or E1) ISDN-PRI facilities, [7-59](#), [7-60](#)
- link administration (remote), [2-15](#)
- Link Failure buttons, [6-21](#)
- list commands
  - objects, [B-7](#)
  - printing, [2-18](#)
- list logins command, [2-11](#)
- list multimedia endpoints command, [11-89](#)
- list multimedia H.320-stations command, [11-89](#)
- Listed Directory Numbers (LDN) feature, [4-410](#) to [4-411](#)
  - see also Centralized Attendant Service (CAS)
  - forms, [4-410](#), [5-207](#)
  - interactions
    - Call Detail Recording (CDR), [4-220](#)
    - deluxe paging, [4-420](#)
    - night console service, [4-411](#)
    - Tenant Partitioning, [4-576](#)
    - trunk group night service, [4-466](#)
  - routing incoming FX and CO trunk calls to attendant groups, [4-411](#)
  - routing of incoming DID trunk calls to attendant groups, [4-410](#)
- Listed Directory Numbers form, [5-207](#) to [5-208](#)
- Local/Normal buttons, [6-19](#)
- lock functions, [4-407](#), [4-615](#)
- Lock LWC buttons, [6-21](#)
- logical agent IDs, [4-541](#)
- Login Administration form, [2-9](#), [2-10](#)
- Login SVN buttons, [6-21](#)
- logins
  - adding login names, [2-8](#)
  - administration commands, [2-8](#)
  - administration form, [2-9](#)
  - Agent Call Handling, [9-9](#)
  - Auto Available Split (AAS), [9-22](#)
  - Automatic Call Distribution (ACD), [9-9](#)
  - changing attributes, [2-10](#)
  - displaying login names, [2-11](#)
  - Expert Agent Selection (EAS), [9-76](#)
  - high priority messages, [4-128](#)
  - listing login names, [2-11](#)
  - passwords, [1-6](#)
  - removing login names, [2-11](#)
  - Security Violation Notification (SVN), [4-535](#)
  - setting permissions, [2-8](#)
  - super user login and password combinations, [2-7](#)
  - system administration terminals (SAT), [2-2](#)
  - system security, [3-2](#)

- Logoff Notification screen, [2-4](#)
- logoffs (system)
  - notifications
    - Facility Test Calls, [4-344](#)
    - Remote Access, [4-513](#)
    - screens, [2-3](#), [2-4](#)
  - system administration terminals (SAT), [2-3](#)
- logouts (agent)
  - Agent Call Handling, [9-9](#)
  - Auto Available Split (AAS), [9-23](#)
  - Automatic Call Distribution (ACD), [9-9](#)
  - Reason Codes, [9-113](#)
  - Redirection on No Answer (RONA), [9-121](#)
- look ahead algorithms, [8-39](#)
- Look Ahead Interflow (LAI) feature, [9-98](#) to [9-103](#)
  - see also* Call Vectoring
  - interactions
    - AAR and ARS, [9-100](#)
    - Agent Terminal Display, [9-101](#)
    - Attendant Control of Trunk Group Access, [9-101](#)
    - Authorization Codes, [9-101](#)
    - Basic Call Management System (BCMS), [9-101](#)
    - Call Detail Recording (CDR), [9-101](#)
    - Call Prompting, [9-102](#)
    - CallVisor ASAI, [4-261](#)
    - Centralized Attendant Service (CAS), [9-102](#)
    - Enhanced Voice Terminal Display, [4-326](#)
    - Expert Agent Selection (EAS), [9-80](#)
    - Facility Restriction Levels (FRL) and Traveling Class Marks (TCM), [9-102](#)
    - Inbound Call Management (ICM), [9-102](#)
    - ISDN, [7-39](#)
    - Service Observing, [4-551](#)
    - Trunk to Trunk Transfer, [9-103](#)
    - VDN of Origin Announcement (VOA), [9-151](#)
    - Voice Response Integration (VRI), [9-157](#)
  - testing, [9-100](#)
- Look Ahead Routing (LAR) feature, [8-45](#) to [8-47](#)
  - activation, [8-46](#)
  - cause values, [8-46](#)
  - controls, [8-45](#)
  - interactions
    - Automatic Circuit Assurance (ACA), [8-47](#)
    - Distributed Communications System (DCS), [8-47](#)
    - Generalized Route Selection (GRS), [8-47](#)
    - ISDN, [7-40](#)
    - QSIG, [8-47](#)
    - Ringback Queuing, [8-47](#)
    - satellite hop limits, [8-47](#)
    - system measurements, [8-47](#)
  - measurements, [8-46](#)
  - termination, [8-46](#)
- loss of frame counts (LOFC), [7-23](#)

- Loudspeaker Paging Access feature, [4-412](#) to [4-418](#)
  - deluxe paging
    - answer back by the paged party, [4-417](#)
    - attendant for another party, [4-416](#)
    - considerations, [4-418](#)
    - detailed description, [4-413](#)
    - end user procedures, [4-415](#)
    - interactions, [4-418](#)
    - meet me conferencing, [4-413](#)
    - meet me paging, [4-413](#)
    - multiappearance voice terminals, [4-416](#)
    - single line voice terminals, [4-415](#)
  - detailed description, [4-412](#)
  - forms, [5-209](#)
  - interactions
    - Attendant Call Waiting, [4-59](#)
    - Busy Verification of Terminals and Trunks (Verify), [4-134](#)
    - Call Park, [4-234](#)
    - Class of Restriction (COR), [4-274](#)
    - Code Calling Access, [4-281](#)
    - DCS Trunk Group Busy/Warning Indication, [12-66](#)
    - Hotline Service, [4-364](#)
    - Internal Automatic Answer (IAA), [4-400](#)
    - Trunk-Group Busy/Warning Indicators to Attendant, [4-608](#)
  - loudspeaker paging
    - considerations, [4-417](#)
    - forms, [4-412](#)
    - interactions, [4-418](#)
    - unparking a call, [4-417](#)
  - PagePac Paging
    - detailed description, [4-414](#)
    - forms, [4-414](#)
    - types of systems, [4-414](#)
- Loudspeaker Paging form, [5-209](#) to [5-211](#)
- low layer compatibility information elements (LLC IE), [8-37](#), [8-38](#)
- Lucent Technologies
  - Bulletin Board, [4-128](#)
  - Centers of Excellence, [xxxvi](#)
  - Corporate Security, [xxxvi](#)
  - DEFINITY Helpline, [xxxvi](#)
  - National Customer Care Center Support Line, [xxx](#), [3-1](#)
  - Technical Design Center, [9-87](#)
  - Technical Service Center, [xxxvi](#), [3-2](#)

---

## M

- Magic-on-Hold system, [4-568](#)
- maid status, [10-2](#), [10-3](#)
- Maintenance-Related System Parameters form, [5-212](#) to [5-219](#)
  - instructions
    - operations support parameters, [5-213](#)
    - scheduled maintenance, [5-215](#)
- maintenance test calls from remote locations, [4-343](#)
- Major Hdwe Failure buttons, [6-22](#)
- Major/Minor Hdwe Failure buttons, [6-22](#)

- make busy activation, [4-427](#)
- Malicious Call Trace (MCT) feature, [4-422](#) to [4-428](#)
  - activation, [4-424](#)
  - Australian public network, [4-423](#)
  - considerations, [4-425](#)
    - Emergency Access to Attendant, [4-425](#)
    - feature access codes (FAC), [4-426](#)
    - Visually Impaired Attendant Service (VIAS), [4-426](#)
  - controlling terminals, [4-424](#)
  - deactivation, [4-425](#)
  - forms, [4-422](#), [5-108](#), [5-199](#)
  - forms for ISDN-BRI, [4-423](#)
  - forms for ISDN-PRI, [4-423](#)
  - interactions
    - Bridged Call Appearance, [4-426](#)
    - Call Pickup, [4-240](#)
    - Call Waiting Termination, [4-427](#)
    - Centralized Attendant Service (CAS), [4-427](#)
    - Conference—Terminal, [4-427](#)
    - Distributed Communications System (DCS), [4-427](#)
    - Emergency Access to Attendant, [4-427](#)
    - Individual Attendant Access, [4-427](#)
    - ISDN, [7-40](#)
    - ISDN—PRI, [4-427](#)
    - make busy activation, [4-427](#)
    - Multimedia Call Handling (MMCH), [11-71](#)
    - Music on Hold Access, [4-427](#)
    - personal central office lines (PCOL), [4-428](#)
    - position busy, [4-427](#)
    - Priority Calling, [4-428](#)
    - QSIG, [4-428](#)
    - QSIG Additional Network Feature Path Replacement (ANF-PR), [12-102](#)
    - R2 multifrequency compelled (MFC) signaling, [4-428](#)
    - Send All Calls (SAC), [4-427](#)
    - Tenant Partitioning, [4-576](#)
    - Transfer, [4-428](#)
    - trunk access codes (TAC), [4-428](#)
  - ISDN notifications, [4-423](#)
  - language displays, [4-30](#)
  - MCT-Activate feature buttons, [4-424](#)
  - MCT-Activation buttons, [6-22](#)
  - MCT-Control buttons, [4-425](#), [6-22](#)
  - MCT Voice Recorder, [4-424](#)
- manual answer, *see under* agents
- Manual-In buttons, [6-22](#)
- manual-in work modes, [9-11](#)
- Manual Message Waiting feature, [4-429](#)
  - interactions
    - Administration without Hardware (AWOH), [4-43](#)
  - Manual Message Waiting buttons, [4-429](#)

- Manual Originating Line Service feature, [4-430](#)
  - interactions
    - Automatic Callback (ACB), [4-102](#)
    - Call Detail Recording (CDR), [4-220](#)
    - Call Forwarding, [4-230](#)
    - Call Pickup, [4-240](#)
    - deluxe paging, [4-420](#)
    - Hotline Service, [4-431](#)
    - Night Service, [4-431](#)
    - QSIG Supplementary Service - Call Completion, [12-94](#)
- Manual Signaling feature, [4-432](#)
  - interactions
    - Administration without Hardware (AWOH), [4-43](#)
    - DCS Distinctive Ringing, [12-64](#)
    - Group Paging, [4-356](#)
    - Ringer Cutoff, [4-525](#)
  - Manual Signaling buttons, [4-432](#)
- MDC9000 cordless voice terminals, [6-163](#), [6-166](#)
- MDW9000 cordless voice terminals, [6-163](#), [6-166](#)
- meet me conferencing, [4-413](#)
- meet me paging, [4-413](#)
- MEGACOM, [7-43](#), [7-120](#), [7-198](#), [7-219](#), [7-262](#)
- MEGACOM 800 DNI, [7-262](#)
- MEGACOM 800 service, [7-120](#), [7-262](#), [9-36](#)
- memory cards
  - failures, [2-21](#)
  - Release 5 si/vs backup, [2-19](#)
  - write-protect switches, [2-22](#)
- MERLIN voice terminals, see 7302H, 7303H and 7305H
- message associated—user to user information (MA-UUI), [12-47](#)
- Message buttons, [6-16](#)
- message centers
  - Demand Print, [4-309](#)
  - Redirection on No Answer (RONA), [9-126](#)
  - Voice Response Integration (VRI), [9-158](#)
- message collection options, [9-60](#)
- message lights
  - Administration without Hardware (AWOH), [4-46](#)
  - Terminal Translation Initialization (TTI), [4-590](#)
- message oriented signaling, [7-19](#)
- Message Retrieve buttons, [6-23](#)
- message servicing adjuncts (MSA), [4-92](#)
- Message Waiting
  - configuration, [10-30](#)
- Message-Waiting Act buttons, [6-23](#)
- Message-Waiting Deact buttons, [6-23](#)
- message waiting lights
  - clear commands, [B-4](#)
  - Expert Agent Selection (EAS), [9-80](#)
- messages
  - displays, [4-92](#)
  - LWC messages, [4-407](#)
  - personal service information, [4-74](#)
  - standard, [4-406](#)
  - storing, [4-406](#)

- Messaging Server (MS) Interface feature, [4-433](#) to [4-437](#)
  - considerations, [4-437](#)
  - detailed description, [4-435](#)
  - EIA connectivity options, [4-435](#)
  - features supported, [4-433](#)
  - forms, [5-179](#), [5-303](#)
  - forms for MS agent hunt groups, [4-435](#)
  - forms for MS service to stations, [4-435](#)
  - forms for R5r, [4-433](#)
  - forms for R5si, [4-434](#)
  - MS agent handled call information, [4-433](#)
  - SCI link connectivity, [4-435](#)
- MF Espana (MFE), [4-439](#)
- MF shuttle signaling, [4-439](#), [7-137](#)
- MF Signaling feature, [4-438](#) to [4-444](#)
  - administering, [4-440](#)
  - automatic number identification (ANI), [4-440](#)
  - definitions of signals, [5-237](#)
  - detailed description, [4-439](#)
  - forms, [4-438](#)
  - interactions
    - Abbreviated Dialing, [4-442](#)
    - Attendant Console, [4-442](#)
    - Authorization Codes, [4-442](#)
    - Automatic Call Distribution (ACD) Splits
      - splits, [4-443](#)
    - Bridging, [4-442](#)
    - Call Detail Recording (CDR), [4-442](#)
    - Call Forwarding, [4-231](#), [4-443](#)
    - call redirection, [4-442](#)
    - Call Vectoring, [4-442](#)
    - CallVisor ASAI, [4-441](#)
    - Dial Plan, [4-313](#)
    - DID no answer timers, [4-442](#)
    - Distributed Communications System (DCS), [4-442](#)
    - Expert Agent Select (EAS), [4-443](#)
    - Hunt Groups, [4-443](#)
    - Intercept Treatment, [4-392](#)
    - Multimedia Call Handling, [4-443](#)
    - Off-Net Call Coverage, [4-443](#)
    - Personal Station Access (PSA), [4-443](#)
    - Remote Access, [4-443](#)
      - station set displays, [4-444](#)
      - tandem/offnet calls, [4-444](#)
- MF Espana (MFE), [4-439](#)
- MF shuttle signaling, [4-439](#)
- R2 multifrequency compelled (MFC) signaling, [4-440](#)
- misoperation alerting, [4-446](#)
- Misoperation Handling feature, [4-445](#) to [4-447](#)
  - analog terminal misoperations, [4-446](#)
  - attendant console misoperations, [4-447](#)
  - detailed description, [4-445](#)
  - digital terminal misoperations, [4-447](#)
  - enhanced operation, [4-446](#)
  - forms, [4-445](#)

- Misoperation Handling feature, (cont)
  - interactions
    - Bridged Call Appearance, [4-448](#)
    - Privacy—Attendant Lockout, [4-448](#)
    - Voice Response Integration (VRI), [4-448](#)
  - misoperation alerting, [4-446](#)
  - standard operation, [4-445](#)
- Mode Code Related System Parameters form, [5-220](#) to [5-222](#)
- mode codes, [4-618](#)
- Mode Related System Parameters form
  - administration commands, [5-220](#)
  - instructions, [5-220](#)
    - mode code parameters, [5-221](#)
    - other related parameters, [5-222](#)
- Modem Pool Group form, [5-223](#) to [5-227](#)
- Modem Pooling feature, [4-449](#) to [4-451](#)
  - combined conversion modems, [4-449](#), [4-450](#)
  - considerations, [4-450](#)
  - detailed description, [4-449](#)
  - forms, [4-449](#), [5-223](#)
  - integrated conversion modems, [4-449](#), [4-450](#)
  - interactions
    - Administered Connections (AC), [4-19](#)
    - Call Detail Recording (CDR), [4-451](#)
    - Data Call Setup, [4-297](#), [4-451](#)
    - Data Only Off Premises Extensions, [4-451](#)
    - Data Privacy, [4-451](#)
    - Data Restriction, [4-451](#)
    - Digital Multiplexed Interface (DMI), [4-451](#), [7-20](#)
    - DS1 Trunk Service, [4-451](#)
    - Extended Trunk Access (ETA), [12-69](#)
    - ISDN—BRI, [4-388](#)
    - Personal Computer (PC) Interface, [6-224](#)
- modular processor data modules (MPDM), [4-291](#), [6-234](#), [6-244](#)
- modular trunk data modules (MTDM), [4-305](#), [6-234](#), [6-244](#)
- month language displays, [4-25](#)
- most idle agents
  - MIA algorithm, [9-28](#)
- most idle agents (MIA)
  - across splits or skills, [9-28](#)
  - across splits/skills, [9-34](#)
  - MIA algorithm, [9-75](#)
  - queues, [9-11](#)
  - skills, [9-76](#)
  - splits, [9-76](#)
- move agent requests, [4-551](#)
- Multiappearance Preselection and Preference feature, [4-452](#) to [4-454](#)
  - interactions
    - Automatic Call Distribution (ACD), [9-39](#)
    - Automatic Incoming Call Display, [4-454](#)
    - Bridged Call Appearance, [4-124](#)
    - Call Coverage, [4-454](#)
    - ISDN—BRI, [4-389](#), [4-454](#)
    - Ringling—Abbreviated and Delayed, [4-530](#)



- multiappearance voice terminals
  - Agent Call Handling, [9-14](#)
  - Bridged Call Appearance, [4-116](#)
  - console permission, [4-278](#)
  - deluxe paging, [4-416](#)
  - Facility Busy Indication, [4-341](#)
  - Intercom—Dial, [4-395](#)
  - Manual Message Waiting, [4-429](#)
  - Privacy—Manual Exclusion, [4-487](#)
  - Ringer Cutoff, [4-523](#)
- Multifrequency-Signaling-Related System Parameters form, [5-228](#) to [5-242](#)
  - administration commands, [5-228](#)
  - implementation notes, [5-228](#)
  - instructions, [5-228](#)
  - signal definitions
    - Group A signals, [5-240](#)
    - Group B signals, [5-241](#)
    - Group I signals, [5-237](#)
    - Group II signals, [5-238](#)
- multifunction boards (MFB), [4-618](#)
- multilanguage displays, [4-640](#)
- Multimedia Applications Server Interface (MASI) feature, [11-2](#) to [11-29](#)
  - AAR and ARS, [11-23](#)
  - administration terminal requirements, [11-3](#)
  - autonomous MMCX features, [11-2](#)
  - basic features not supported, [11-25](#)
  - Call Center features not supported, [11-25](#)
  - Call Detail Recording (CDR), [11-23](#)
  - call redirection, [11-24](#)
  - caution, [11-3](#)
  - command permissions, [11-22](#)
  - Conferencing, [11-24](#)
  - configurations, [11-5](#)
  - DEFINITY/MASI features, [11-2](#)
  - detailed feature description, [11-23](#)
  - error conditions, [11-29](#)
  - features not supported, [11-25](#)
  - forms, [11-9](#)
  - how to administer, [11-9](#) to [11-22](#)
  - interactions, [11-25](#)
    - attendant features, [11-26](#)
    - basic features, [11-27](#)
    - Hospitality features, [11-28](#)
    - multimedia features, [11-28](#)
  - planning for MASI, [11-4](#)
  - status tracking, terminals and trunk, [11-24](#)
  - terms, [11-3](#)
  - Transfer, [11-24](#)
  - troubleshooting, [11-29](#)
  - trunk groups, [11-24](#)
  - voice messaging access, [11-24](#)
- Multimedia Call Handling (MMCH) feature, [11-30](#) to [11-97](#)
  - 1-number access, [11-59](#), [11-73](#)
  - authorization, [11-64](#)
  - call association (routing), [11-70](#), [11-85](#)
  - call redirection, [11-65](#)
  - conferencing, [11-65](#)
  - considerations, [11-90](#), [11-97](#)
  - endpoint software packages, [11-34](#)

- Multimedia Call Handling (MMCH) feature, (cont)
  - forms, [11-39](#)
  - interactions
    - Administered Connections (AC), [11-65](#), [11-86](#)
    - Administration without Hardware (AWOH), [11-65](#), [11-86](#)
    - Authorization Codes, [11-65](#)
    - Bridged Call Appearance, [11-65](#), [11-86](#)
    - Call Coverage, [11-66](#)
    - Call Detail Recording (CDR), [11-66](#), [11-86](#)
    - Call Forwarding, [11-68](#)
    - Call Park, [11-69](#), [11-86](#)
    - Call Pickup, [4-241](#), [11-69](#), [11-86](#)
    - CallVisor ASAI, [11-65](#)
    - Class of Restriction (COR), [11-69](#), [11-87](#)
    - Class of Service (COS), [11-69](#), [11-87](#)
    - Consult, [11-69](#), [11-86](#)
    - Data Call Setup, [11-69](#), [11-87](#)
    - Data Hotline, [11-69](#), [11-87](#)
    - Dial Access to Attendant, [11-69](#)
    - Digital Multiplexed Interface (DMI), [11-69](#)
    - Hold, [11-69](#)
    - Hunt Groups, [11-69](#)
    - Intercept Treatment, [11-71](#)
    - ISDN-PRI, [11-71](#), [11-87](#)
    - Malicious Call Trace (MCT), [11-71](#)
    - message waiting, [11-71](#)
    - Night Service, [11-72](#), [11-87](#)
    - Remote Access, [11-72](#), [11-87](#)
    - Station Hunting, [4-561](#), [11-72](#), [11-87](#)
    - Tenant Partitioning, [11-72](#)
    - Terminating Extension Group (TEG), [11-72](#), [11-87](#)
    - Voice Terminal Display, [11-72](#), [11-88](#)
  - list commands, [11-89](#)
  - monitor commands, [11-88](#)
  - multimedia complexes, [11-31](#)
  - status commands, [11-89](#)
- Multimedia Call Handling feature
  - interactions
    - MF Signaling, [4-443](#)
- multimedia endpoints, [4-261](#), [12-94](#)
- Multimedia features
  - Multimedia Applications Server Interface (MASI), [11-2](#)
  - Multimedia Call Handling (MMCH), [11-30](#)
- Multimedia forms, [11-39](#)
  - Data Module form
    - administration commands, [11-41](#)
    - screen, [11-46](#)
  - Hunt Group form, [11-56](#)
  - Station form
    - administration commands, [11-41](#)
    - duplicating multimedia endpoints, [11-45](#)
- multiparty calls, [4-87](#)
- Multiple Call Handling (MCH) feature, [9-104](#) to [9-109](#)
  - applications, [9-104](#)
  - considerations, [9-107](#)
  - example, [9-105](#)

Multiple Call Handling (MCH) feature, (cont)

forms, [9-104](#)

interactions

Agent Call Handling, [9-20](#)

call work codes (CWC), [9-108](#)

direct agent calling (DAC), [9-108](#)

Expert Agent Selection (EAS), [9-104](#)

Hold—Automatic, [9-108](#)

move agent while staffed, [9-108](#)

nonACD calls, [9-108](#)

queues, [9-108](#)

Redirection on No Answer (RONA), [9-109](#), [9-127](#)

restricted line appearance, [9-109](#)

Service Observing, [4-551](#)

stroke counts, [9-108](#)

settings

many forced, [9-107](#)

on request splits/skills, [9-105](#)

one forced, [9-106](#)

one per skill MCH, [9-106](#)

work modes, [9-107](#)

Multiple Music-on-Hold, [4-573](#)

multiple splits, *see under* splits

multiple voice terminals, *see* voice terminals, duplicate command

multipoint configurations on BRI ports, [4-383](#)

multiquest flexible billing, [7-48](#)

music on delay, [4-551](#)

Music on Hold Access feature, [4-455](#)

interactions

Attendant Call Waiting, [4-59](#)

Automatic Call Distribution (ACD), [4-456](#)

Call Park, [4-234](#)

CallVisor ASAI, [4-261](#)

Data Privacy, [4-302](#), [4-456](#)

Data Restriction, [4-304](#), [4-456](#)

deluxe paging, [4-420](#)

Hold, [4-360](#)

Hunt Groups, [4-456](#)

Malicious Call Trace (MCT), [4-427](#)

Redirection on No Answer (RONA), [9-127](#)

Service Observing, [4-551](#)

Tenant Partitioning, [4-577](#)

Voice Response Integration (VRI), [9-158](#)

music sources, [4-573](#)

Music Sources form, [5-243](#) to [5-245](#)

administration commands, [5-243](#)

implementation notes, [5-245](#)

instructions, [5-244](#)

---

## N

N x DS0 channels, [7-65](#)

N747B CO trunk circuit packs, [7-168](#)

N2184 DIOD trunk circuit packs, [7-183](#)

- Names Registration feature, [10-17](#) to [10-20](#)
  - call coverage, [10-19](#)
  - check in, [10-17](#)
  - check out, [10-18](#)
  - client room COS, [10-19](#)
  - considerations, [10-19](#)
  - detailed description, [10-17](#)
  - guest information input/change, [10-18](#)
  - information format, [10-18](#)
  - interactions, [10-19](#)
  - interface, [10-19](#)
  - name character length, [10-20](#)
- narrowband calls, [7-67](#)
- National Customer Care Center Support Line, [xxxvi](#), [3-1](#)
- National ISDN-1 Services (NI-1), [6-194](#)
- National ISDN-2 Services (NI-2), [7-32](#)
  - Call by Call (CBC) Service Selection, [7-32](#)
  - calling line identification, [7-32](#)
  - D-Channel Backup, [7-32](#)
  - Nonfacility Associated Signaling (NFAS), [7-32](#)
  - Wideband Switching, [7-32](#)
- NATO timers, [9-129](#)
- netcon channels, [1-7](#), [2-15](#)
- netcon circuit packs, [2-21](#)
- netcon data modules, [6-245](#)
- network answer supervision, [4-600](#)
- network answer supervision detection, [4-52](#)
- Network-Facilities form, [7-100](#), [7-122](#)
- network specific facilities (NSF), [7-45](#)
- Next buttons, [6-23](#), [9-172](#)
- Next Message buttons, [4-75](#), [4-628](#)
- Night Service feature
  - trunk group night service
    - Trunk Night Service buttons, [4-460](#)
- Night Service features
  - hunt group night service
    - Attendant Priority Queue, [4-87](#)
    - Automatic Call Distribution (ACD), [4-463](#), [9-39](#)
    - Call Coverage, [4-463](#)
    - call forwarding—all calls, [4-463](#)
    - considerations, [4-460](#)
    - description, [4-457](#)
    - forms, [4-457](#)
    - Hunt Groups, [4-372](#)
  - interactions
    - Basic Call Management System (BCMS), [9-42](#)
    - Call Coverage, [4-165](#)
    - Call Detail Recording (CDR), [4-220](#)
    - Call Vectoring, [9-69](#)
    - Emergency Access to Attendant, [4-321](#)
    - Inter-PBX Attendant Service (IAS), [12-73](#)
    - Manual Originating Line Service, [4-431](#)
    - Multimedia Call Handling (MMCH), [11-72](#), [11-87](#)
    - Power Failure Transfer, [4-482](#)
    - Remote Access, [4-514](#)
    - Service Observing, [4-551](#)
    - Station Hunting, [4-561](#)
- Night buttons, [4-458](#), [4-459](#)

Night Service features, (cont)

night console service

- Automatic Circuit Assurance (ACA), [4-106](#)
- Centralized Attendant Service (CAS), [12-9](#)
- considerations, [4-461](#)
- description, [4-457](#)
- form, [4-458](#)
- Individual Attendant Access, [4-378](#)
- Listed Directory Numbers (LDN), [4-411](#)
- night station service, [4-464](#)
- Ringling—Abbreviated and Delayed, [4-528](#)
- Send All Calls (SAC), [4-538](#)
- Tenant Partitioning, [4-577](#)
- trunk answer from any station (TAAS), [4-459](#), [4-465](#)
- trunk group night service, [4-463](#)

Night-Serv buttons, [6-23](#), [4-461](#)

Night Service buttons, [4-457](#), [4-459](#)

night service disconnect timers, [4-460](#)

night service extensions (NSE), [4-457](#), [4-460](#), [4-510](#)

night station service

- Administration without Hardware (AWOH), [4-44](#), [4-45](#)
- Call Coverage, [4-464](#)
- call forwarding—all calls, [4-464](#)
- Class of Restriction (COR), [4-275](#)
- considerations, [4-461](#)
- deluxe paging, [4-420](#)
- description, [4-458](#)
- forms, [4-458](#)
- incoming call routing, [4-458](#)
- inward restriction, [4-464](#)
- night console service, [4-464](#)
- Redirection on No Answer (RONA), [9-127](#)
- Remote Access, [4-464](#)
- Tenant Partitioning, [4-464](#)
- Terminal Translation Initialization (TTI), [4-588](#)
- Timed Reminder and Attendant Timers, [4-464](#)
- trunk answer from any station (TAAS), [4-464](#), [4-465](#)

trunk answer from any station (TAAS)

- Attendant Backup Alerting, [4-56](#)
- Call Coverage, [4-465](#)
- call forwarding—all calls, [4-465](#)
- Centralized Attendant Service (CAS), [12-9](#)
- Class of Restriction (COR), [4-275](#)
- considerations, [4-461](#)
- description, [4-459](#)
- forms, [4-459](#)
- inward restriction, [4-465](#)
- night console service, [4-465](#)
- night station service, [4-464](#), [4-465](#)
- Tenant Partitioning, [4-465](#), [4-577](#)

trunk group night service

- Administration without Hardware (AWOH), [4-47](#)
- call forwarding—all calls, [4-465](#)
- description, [4-460](#)
- forced first announcements, [4-465](#)

Night Service features, trunk group night service (cont)  
    forms, [4-460](#)  
    Listed Directory Numbers (LDN), [4-466](#)  
    night console service, [4-463](#)  
    Trunk Night Service buttons, [4-460](#)  
    Trunk-Grp buttons, [6-25](#)  
    trunk-group night service  
        considerations, [4-462](#)  
Node Number Routing (NNR) feature, [12-74](#)  
Node Number Routing form, [12-119](#) to [12-120](#)  
nonACD calls, [9-108](#)  
nonattendant consoles, [12-9](#)  
noncall associated-temporary signaling connections (NCA-TSC), [12-48](#), [12-79](#)  
nonintelligent terminal settings, [6-240](#)  
nonvector controlled splits, *see under* splits  
Normal buttons, [4-145](#), [4-613](#)  
normal display modes, [4-74](#), [4-82](#), [4-626](#)  
Normal Mode buttons, [4-381](#), [6-23](#)  
Novell Telephony Services, [4-326](#)  
Number of Digits from PMS, [10-34](#)  
Number of Digits in PMS Coverage Path, [10-35](#)  
Number of Housekeeper ID Digits, [10-31](#)  
number of queued calls (NQC)  
    hunt groups, [9-111](#)  
    NQC buttons, [6-24](#)  
numbering plan identifiers (NPI), [8-58](#)

---

## O

off hook alerts, [4-278](#)  
Off Premises Station feature, [4-467](#)  
    interactions  
        Attendant Priority Queue, [4-87](#)  
        Call Detail Recording (CDR), [4-221](#)  
        Distinctive Ringing, [4-468](#)  
        Ringing—Abbreviated and Delayed, [4-530](#)  
offnet (tandem) calls, [4-444](#)  
oldest queued times (OQT), [9-111](#)  
    OQT buttons, [6-24](#)  
on switch resource status, [4-69](#)  
OneVision Network Management Solutions, [4-51](#)  
Onhook Dialing, [4-469](#)  
open system interconnect (OSI) models, [4-382](#), [7-25](#)  
operational status, [B-9](#)  
optional digital terminal data modules (DTDM), [6-91](#)  
optional features, [1-3](#)  
optional messaging cartridges, [6-92](#)  
origination restrictions, [4-281](#)  
    *see also* Class of Restriction (COR)  
outbound call management (OCM)  
    OCM applications, [5-289](#)  
    OCM call classification forms, [4-226](#)  
outgoing trunk queueing, [12-94](#)  
outward restrictions, *see* Restriction—Controlled  
Override buttons, [4-84](#)

## P

- packet control (PACCON) boards, [7-16](#)
- packet gateway (pgate) boards, [12-11](#)
- Packet Gateway Board form, [5-246](#) to [5-247](#)
- packet interface (PKTINT) boards, [7-16](#)
- PagePac paging
  - PagePac 20, [4-414](#)
  - PagePac 50/100/200, [4-414](#)
  - PagePac VS, [4-414](#)
- paging code-calling-ids (form), *see* Code Calling IDs form
- paging loudspeaker (form), *see* Loudspeaker Paging form
- parameters
  - attendant consoles, [1-7](#)
  - login names, [2-8](#)
  - system, [1-7](#)
- Parisian French for PC Console, [4-470](#)
- partitioned group numbers (PGN), [4-96](#), [8-21](#)
- party identifiers, [4-34](#)
- Passageway Direct Connect, [4-326](#)
- passwords
  - aging, [2-11](#)
  - encryption, [3-2](#)
  - how to enter, [2-3](#)
  - logins, [1-6](#)
  - remote port security devices (RPSD), [3-2](#)
  - security measures, [4-621](#)
  - super user login and password combinations, [2-7](#)
- PC Console feature, [4-470](#)
  - interactions
    - Do Not Disturb (DND), [10-14](#)
- PC/PBX Connection feature, [4-471](#) to [4-473](#)
  - forms, [4-471](#)
  - interactions
    - call log, [4-472](#)
    - Tenant Partitioning, [4-577](#)
  - security measures, [4-471](#)
  - software requirements, [4-472](#)
- PCOL Trunk Group form, [7-246](#) to [7-251](#)
  - field descriptions, [7-122](#), [7-248](#)
  - implementation notes, [7-248](#)
  - interactions, [7-250](#)
- permission for coverage message retrievals, [4-82](#)
- personal central office lines (PCOL)
  - AAR and ARS, [8-18](#)
  - Administration without Hardware (AWOH), [4-43](#)
  - Bridged Call Appearance, [4-124](#)
  - Call Detail Recording (CDR), [4-221](#)
  - Call Forwarding, [4-231](#)
  - Class of Restriction (COR), [4-275](#)
  - deluxe paging, [4-420](#)
  - Hold, [4-360](#)
  - Malicious Call Trace (MCT), [4-428](#)
  - Ringin—Abbreviated and Delayed, [4-528](#), [4-530](#)
  - Station Hunting, [4-562](#)
  - Transfer—Outgoing Trunk to Outgoing Trunk Transfer (OTTOTT), [4-601](#)
  - trunk group forms, [7-246](#)

- Personal Computer (PC) Interface feature, [6-220](#) to [6-224](#)
  - considerations, [6-223](#)
  - DCP PC configurations (Group 1), [6-221](#)
  - interactions
    - data protection, [6-224](#)
    - host computer access, [6-224](#)
    - ISDN-BRI, [6-224](#)
    - Modem Pooling, [6-224](#)
    - Tenant Partitioning, [4-577](#)
  - ISDN-BRI PC configurations (Group 2), [6-222](#)
  - security alerts, [6-223](#)
- personal computers (PC)
  - integrated workstations, [4-471](#)
  - system administration terminals (SAT), [2-2](#)
- personal number lists, [4-3](#), [4-4](#), [4-8](#)
- personal service information, [4-74](#)
- Personal Station Access (PSA) feature, [4-474](#) to [4-479](#)
  - button mapping, [4-474](#)
  - considerations, [4-477](#)
  - detailed description, [4-474](#)
  - dissociating from PSA, [4-477](#)
  - end user procedures, [4-475](#)
  - forms, [4-474](#)
  - interactions
    - Bridged Call Appearance, [4-478](#)
    - Call Coverage, [4-479](#)
    - Call Management System (CMS), [4-479](#)
    - CallVisor ASAI, [4-478](#)
    - MF Signaling, [4-443](#)
    - Property Management System (PMS) Interface, [4-479](#)
    - Security Violation Notification (SVN), [4-479](#)
    - Station Hunting, [4-562](#)
    - Station Security Codes (SSC), [4-565](#)
    - Tenant Partitioning, [4-479](#)
    - Terminal Self Administration (TSA), [4-581](#)
    - Terminal Translation Initialization (TTI), [4-590](#)
  - interrupting the associate command sequence, [4-477](#)
  - permissible associations, [4-478](#)
- Personalized Ringing feature, [4-480](#) to [4-481](#)
  - interactions
    - Distinctive Ringing, [4-316](#), [4-481](#)
    - power failures, [4-481](#)
  - phantom stations, [4-41](#), [6-38](#)
- Pickup Group form, [5-256](#) to [5-257](#)
- PictureTel, [11-34](#)
- PMS Link Maximum Retransmission Requests, [10-32](#)
- PMS Link Maximum Retransmissions, [10-32](#)
- PMS Protocol Mode, [10-31](#)
- PMS Sends Prefix, [10-35](#)
- port network (PN) preferential trunk routing, [7-62](#)
- port network connectivity (PNC), [5-104](#)
- ports
  - assignment records, [1-5](#)
  - retrieving data, [B-7](#)
  - system access, [2-15](#)
- position busy, [4-427](#)
- position-busy buttons, [4-66](#)



- Power Failure Transfer feature, [4-482](#)
  - interactions
    - Customer Provided Equipment (CPE) Alarm, [4-289](#)
  - power failure transfer terminals, [4-482](#)
- power outages and translations, [1-6](#)
- pr (print) command, [2-18](#)
- preprinted labels, [1-5](#)
- PRI Endpoint form, [7-102](#) to [7-106](#), [7-122](#)
- PRI endpoints (PE), [7-59](#)
- PRI-VRU adjuncts, [4-346](#)
- primary level terminal parameters, [6-13](#)
- primary port networks (PPN), [4-260](#)
- primary transmission path failures, [7-61](#)
- print (pr) command, [2-18](#)
- Print Msgs buttons, [6-24](#)
- printers
  - asynchronous data units (ADU), [6-239](#)
  - data line circuit (DLC) packs, [6-239](#)
  - on-demand printing command, [2-18](#)
- Priority Calling feature, [4-483](#) to [4-485](#)
  - interactions
    - Abbreviated Dialing (AD), [4-484](#)
    - Administration without Hardware (AWOH), [4-43](#)
    - Bridged Call Appearance, [4-125](#), [4-484](#)
    - Call Coverage, [4-162](#), [4-484](#)
    - call forwarding—all calls, [4-484](#)
    - Call Vectoring, [4-484](#), [9-69](#)
    - Call Waiting Termination, [4-484](#)
    - CallVisor ASAI, [4-261](#)
    - Consult, [4-484](#)
    - Data Privacy, [4-302](#)
    - Data Restriction, [4-304](#)
    - Dial Access to Attendant, [4-484](#)
    - Distributed Communications System (DCS), [4-485](#)
    - Hold, [4-360](#)
    - Hunt Groups, [4-372](#)
    - Inbound Call Management (ICM), [9-88](#)
    - Last Number Dialed, [4-485](#)
    - Malicious Call Trace (MCT), [4-428](#)
    - Restriction—Controlled, [4-519](#)
    - Ringer Cutoff, [4-525](#)
    - Ringling—Abbreviated and Delayed, [4-528](#)
    - Security Violation Notification (SVN), [4-485](#), [4-537](#)
    - Station Hunting, [4-562](#)
    - Voice Terminal Alerting Options, [4-625](#)
    - Whisper Page, [4-640](#)
- Priority Call buttons, [4-484](#), [6-24](#)
- priority call waiting tones, [4-244](#)
- types of priority calling calls, [4-483](#)
- priority messages, [4-128](#)
- priority queuing, [4-85](#), [4-321](#), [9-33](#)

- Privacy—Attendant Lockout feature, [4-486](#)
  - interactions
    - Attendant Recall, [4-486](#)
    - Group Paging, [4-354](#)
    - Individual Attendant Access, [4-378](#), [4-486](#)
    - Misoperation Handling, [4-448](#)
    - Trunk to Trunk Transfer, [4-486](#), [4-612](#)
    - Whisper Page, [4-640](#)
- Privacy—Manual Exclusion feature, [4-487](#)
  - interactions
    - Bridged Call Appearance, [4-125](#), [4-487](#)
    - Call Coverage, [4-165](#), [4-487](#)
    - Call Pickup, [4-241](#), [4-488](#)
    - CallVisor ASAI, [4-261](#)
    - Group Paging, [4-354](#)
    - Temporary Bridged Appearance, [4-567](#)
    - Terminating Extension Group (TEG), [4-592](#)
  - manual exclusion buttons, [4-354](#)
- private line data facilities, [4-305](#)
- Private Network Access feature, [12-75](#) to [12-76](#)
  - forms, [8-63](#), [12-75](#)
  - interactions
    - Attendant Call Waiting, [12-76](#)
    - Attendant Intrusion (Call Offer), [12-76](#)
    - Call Detail Recording (CDR), [4-221](#)
    - Class of Restriction (COR), [4-274](#)
- private network nodes, [12-74](#)
- private network numbering plans, [8-63](#)
- private network services, [7-30](#)
- private network trunks, [7-119](#)
- Private Networking features
  - Centralized Attendant Service (CAS), [12-4](#)
  - DCS Alphanumeric Display for Terminals, [12-27](#)
  - DCS Attendant Control of Trunk Group Access, [12-28](#)
  - DCS Attendant Direct Trunk Group Selection, [12-29](#)
  - DCS Attendant Display, [12-31](#)
  - DCS Automatic Callback (ACB), [12-32](#)
  - DCS Automatic Circuit Assurance (ACA), [12-34](#)
  - DCS Busy Verification of Terminals and Trunks, [12-35](#)
  - DCS Call Coverage, [12-36](#)
  - DCS Call Forwarding, [12-41](#)
  - DCS Call Waiting, [12-42](#)
  - DCS Distinctive Ringing, [12-43](#)
  - DCS Leave Word Calling (LWC), [12-44](#)
  - DCS Multiappearance Conference/Transfer, [12-46](#)
  - DCS Over ISDN-PRI D-Channel (DCS+), [12-47](#)
  - DCS Trunk Group Busy/Warning Indication, [12-52](#)
  - DCS with Rerouting, [12-50](#)
  - Distributed Communications System (DCS), [12-11](#)
  - Enhanced DCS (EDCS), [12-55](#)
  - Extended Trunk Access (ETA), [12-67](#)
  - Extension Number Portability (ENP), [12-70](#)
  - Inter-PBX Attendant Service (IAS), [12-72](#)
  - Node Number Routing (NNR), [12-74](#)
  - Private Network Access, [12-75](#)
  - QSIG, [12-77](#), [12-96](#)
  - QSIG Additional Network Feature Path Replacement (ANF-PR), [12-90](#)
  - QSIG Additional Network Feature-Transit Counter (ANF-TC), [12-96](#)

- Private Networking features, (cont)
    - QSIG Call Forwarding (Diversion), [12-82](#)
    - QSIG Call Transfer, [12-84](#)
    - QSIG Name and Number Identification, [12-86](#)
    - Uniform Dial Plan (UDP), [12-103](#)
  - Private Networking forms, [12-109](#)
  - private networks, [8-3](#)
  - private numbering plans (PNP), [7-93](#), [8-58](#)
  - privileged system number lists, [4-276](#)
  - Processor Channel Assignment (R5i) form, [5-248](#) to [5-251](#)
  - Processor Channel Assignment (R5si) form, [5-252](#) to [5-255](#)
  - processor data modules (PDM), [6-246](#), [9-59](#), [12-11](#)
  - processor interface (PI) boards, [6-226](#), [6-246](#), [7-16](#), [12-11](#)
  - processor/trunk data modules (P/TDM), [6-226](#)
  - programmable function keys, [2-2](#)
  - Property Management System (PMS) Interface feature, [10-21](#) to [10-28](#)
    - audit trail reports, [10-23](#)
    - check in-check out, [10-25](#)
    - considerations, [10-27](#)
    - detailed description, [10-22](#)
    - forms, [5-204](#), [10-21](#)
    - guest information input/change, [10-26](#)
    - housekeeping status, [10-25](#)
    - interactions
      - Attendant Console, [10-28](#)
      - AUDIX, [10-28](#)
      - Automatic Wakeup, [10-10](#), [10-28](#)
      - Call Vectoring, [9-70](#)
      - Do Not Disturb (DND), [10-14](#), [10-28](#)
      - Leave Word Calling (LWC), [10-28](#)
      - Personal Station Access (PSA), [4-479](#)
      - Restriction—Controlled, [10-28](#)
      - Single Digit Dialing and Mixed Station Numbering, [4-556](#)
  - language displays, [4-35](#)
  - message waiting notification, [10-24](#)
  - names registration, [10-26](#)
  - normal protocol modes, [10-23](#)
  - PMS Failure buttons, [6-23](#)
  - PMS/INTUITY message tandeming, [10-27](#)
  - PMS Ptr Alarm buttons, [6-24](#)
  - PMS/switch links table, [10-22](#)
  - protocol modes, [10-23](#)
  - Restriction—Controlled, [10-24](#)
  - room change/room swap, [10-26](#)
  - switch links, [10-22](#)
  - transparent protocol modes, [10-23](#)
- Proshare, [11-34](#)
- protocol mode, [10-31](#)
- PSI (Expert System), [4-51](#)
- Public Network Call Priority feature, [4-489](#) to [4-495](#)
  - China
    - forced disconnect, [4-490](#)
    - forms, [4-489](#)
    - intrusion interactions, [4-581](#)
    - mode of release control interactions, [4-492](#)
    - mode of release control types, [4-490](#)
    - re-ring description, [4-491](#)
    - re-ring interactions, [4-493](#)

- Public Network Call Priority feature, (cont)
  - form, [8-63](#)
  - Russia
    - forms, [4-489](#)
    - intrusion description, [4-491](#)
    - intrusion interactions, [4-493](#), [4-581](#)
    - rering description, [4-491](#)
    - rering interactions, [4-493](#), [4-581](#)
  - Spain
    - call retention, [4-491](#)
    - forms, [4-489](#)
    - re-ring, [4-491](#)
    - rering interactions, [4-581](#)
- public networks
  - access, [4-509](#)
  - ARS, [8-3](#)
  - numbering plans, [4-76](#), [8-11](#), [8-20](#), [8-63](#)
  - signaling administration, [7-17](#)
  - trunks, [7-120](#), [7-121](#)
  - unauthorized access, [4-343](#)
- Pull Transfer feature, [4-496](#)
  - interactions
    - analog station recall operation and feature activation, [4-496](#)
    - AUDIX, [4-496](#)
    - Call Detail Recording (CDR), [4-496](#)
    - digital station transfer operation, [4-497](#)
    - ISDN–BRI stations, [4-496](#)
    - nonISDN–BRI stations, [4-497](#)

---

## Q

- Q.932 facilities information elements (FIE), [4-250](#)
- Q-reference points, [12-77](#)
- QSIG – CO. See QSIG Supplementary Service – Call Offer feature
- QSIG Additional Network Feature Path Replacement (ANF–PR) feature, [12-90](#)
  - interactions
    - Basic Call Management System (BCMS), [12-101](#)
    - Call Detail Recording (CDR), [12-101](#)
    - Call Management System (CMS), [12-101](#)
    - Call Vectoring, [12-101](#)
    - Data Call Setup, [12-101](#)
    - Data Privacy, [12-102](#)
    - Data Restriction, [12-102](#)
    - Malicious Call Trace (MCT), [12-102](#)
    - QSIG Call Transfer, [12-101](#)
    - Recorded Announcement, [12-102](#)
    - trunk access codes (TAC), [12-102](#)
    - Voice Terminal Display, [12-102](#)
- QSIG Additional Network Feature–Transit Counter (ANF–TC) feature, [12-99](#), [12-102](#)
- QSIG busy name display, [12-87](#)

- QSIG Call Forwarding (Diversion) feature, [12-82](#), [12-82](#) to [12-83](#)
  - forms, [12-83](#)
  - interactions
    - AAR and ARS, [12-100](#)
    - Alternate Facility Restriction Levels (AFRL), [12-99](#)
    - Authorization Codes, [12-99](#)
    - Call Coverage, [12-100](#)
    - Call Detail Recording (CDR), [12-100](#)
    - Call Forwarding, [12-100](#)
    - Distributed Communications System (DCS), [12-100](#)
    - Facility Restriction Levels (FRL) and Traveling Class Marks (TCM), [12-100](#)
    - QSIG Name and Number Identification, [12-100](#)
    - terminating call has coverage active, [12-100](#)
    - Transfer, [12-100](#)
- QSIG Call Transfer feature, [12-84](#)
  - forms, [12-85](#)
  - interactions
    - Call Forwarding, [12-100](#)
    - Distributed Communications System (DCS), [12-101](#)
    - QSIG Additional Network Feature Path Replacement (ANF-PR), [12-101](#)
    - QSIG Name and Number Identification, [12-101](#)
- QSIG called name display, [12-87](#)
- QSIG feature
  - call associated-temporary signaling connections (CA-TSC), [12-79](#)
- QSIG Features
  - QSIG NCA-TSC, [12-80](#)
- QSIG features, [12-77](#) to [12-81](#)
  - see also* specific QSIG features
  - additional network features (ANF), [12-79](#)
  - Busy name, [12-80](#)
  - Called name, [12-80](#)
  - detailed description, [12-79](#)
  - forms, [12-77](#)
  - interactions, [12-99](#)
    - Attendant Control of Trunk Group Access, [4-64](#)
    - Attendant Direct Trunk Group Selection, [4-73](#)
    - Call Charge Information, [4-144](#)
    - Call Forwarding, [4-231](#)
    - CallVisor ASAI, [4-261](#)
    - Enhanced Voice Terminal Display, [4-326](#)
    - Look Ahead Routing (LAR), [8-47](#)
    - Malicious Call Trace (MCT), [4-428](#)
    - Transfer, [4-598](#)
    - Transfer—Outgoing Trunk to Outgoing Trunk Transfer (OTTOTT), [4-601](#)
    - Whisper Page, [4-640](#)
  - levels of functionality, [12-77](#)
  - noncall associated-temporary signaling connections (NCA-TSC), [12-79](#)
  - QSIG Path Retention, [12-80](#)
  - QSIG signaling protocols, [12-79](#)
  - supplementary services, [12-78](#)
- QSIG Name and Number Identification feature, [12-86](#) to [12-89](#)
  - called/busy name display, [12-87](#)
  - forms, [12-88](#)

- QSIG Name and Number Identification feature, (cont)
  - interactions
    - Distributed Communications System (DCS), [12-101](#)
    - QSIG Call Forwarding (Diversion), [12-100](#)
    - QSIG Call Transfer, [12-101](#)
  - ISDN numbering formats, [12-87](#)
  - tandem switch information, [12-86](#)
  - transit switch information, [12-86](#)
- QSIG NCA-TSC, [12-80](#)
- QSIG Path Replacement (ANF-PR), [12-90](#)
- QSIG Path Retention, [12-80](#)
- QSIG Supplementary Service - Call Completion feature, [12-91](#) to [12-95](#)
  - detailed description, [12-92](#)
  - forms, [12-91](#)
  - interactions
    - Adjunct Switch Applications Interface (ASAI), [12-93](#)
    - Attendant Call Waiting, [12-93](#)
    - Attendant Console Group, [12-93](#)
    - Attendant Control of Trunk Group Access, [12-93](#)
    - AUDIX, [12-93](#)
    - Automatic Call Distribution (ACD), [12-93](#)
    - Bridged Call Appearance, [12-94](#)
    - Call Coverage, [12-94](#)
    - Call Forwarding, [12-94](#)
    - Call Pickup, [12-94](#)
    - Call Waiting, [12-94](#)
    - Call Waiting Termination, [12-93](#)
    - Direct Department Calling, [12-95](#)
    - Hold, [12-94](#)
    - Hotline Service, [12-94](#)
    - Internal Automatic Answer (IAA), [12-94](#)
    - Manual Originating Line Service, [12-94](#)
    - Multimedia Endpoints, [12-94](#)
    - Outgoing Trunk Queueing, [12-94](#)
    - Termination Extension Group (TEG), [12-95](#)
    - Transfer, [12-94](#)
    - Uniform Call Distribution, [12-95](#)
    - Vector Directory Numbers, [12-95](#)
- QSIG Supplementary Service – Call Offer feature, [12-96](#) to [12-98](#)
  - completed, [12-96](#)
  - description, [12-98](#)
  - forms, [12-98](#)
  - invoking, [12-96](#)
  - successful, [12-96](#)
- Queue Status Indications feature, [9-110](#) to [9-111](#)
  - interactions
    - Attendant Display, [9-111](#)
    - Call Management System (CMS), [9-111](#)
    - Expert Agent Selection (EAS), [9-80](#)
    - Redirection on No Answer (RONA), [9-127](#)
    - Voice Terminal Display, [9-111](#)
    - VuStats, [9-191](#)
  - language displays, [4-31](#)
  - oldest queued times (OQT), [9-111](#)

queues

- Attendant Serial Calling, [4-91](#)
- Centralized Attendant Service (CAS), [12-5](#)
- DCS Call Coverage, [12-63](#)
- hunt groups, [4-366](#)
- most idle agents (MIA), [9-11](#)
- Multiple Call Handling (MCH), [9-108](#)
- number of queued calls (NQC), [9-111](#)
- oldest queued times (OQT), [9-111](#)
- ordered (first in, first out), [4-520](#)
- outgoing trunks (OTQ), [4-562](#)
- priority levels, [4-85](#), [9-33](#)
- Recorded Announcement, [4-500](#)
- Redirection on No Answer (RONA), [9-127](#)
- split, [9-32](#)
- status indications, [9-33](#)
- status indicators, [9-5](#), [9-191](#)
- Voice Response Integration (VRI), [9-152](#), [9-158](#)
- warning levels, [4-55](#)

---

**R**

- R2 multifrequency compelled (MFC) signaling, [4-440](#)
  - CallVisor ASAI, [4-261](#)
  - Malicious Call Trace (MCT), [4-428](#)
  - Voice Response Integration (VRI), [9-158](#)
- R5.4 to R6.1 transition reference, [A-1](#)
- Reason Code Names form, [9-211](#)
- Reason Codes feature, [9-112](#) to [9-115](#)
  - auxiliary (AUX) work modes, [9-113](#)
  - considerations, [9-114](#)
  - default codes, [9-114](#)
  - forced reason codes, [9-113](#)
  - forms, [9-112](#)
  - interactions
    - Abbreviated Dialing (AD), [9-115](#)
    - Auto Available Split (AAS), [9-115](#)
    - Basic Call Management System (BCMS), [9-115](#)
    - Call Management System (CMS), [9-115](#)
    - CallVisor ASAI, [9-115](#)
    - direct agent calling (DAC), [9-115](#)
    - multiple skills, [9-115](#)
    - Redirection on No Answer (RONA), [9-115](#)
    - VuStats, [9-191](#)
  - requested reason codes, [9-113](#)
- Recall buttons, [4-88](#), [4-100](#), [4-415](#)
- Recall Signaling feature, [4-498](#)
- record keeping, [1-5](#)
- Recorded Announcement feature, [4-500](#) to [4-507](#)
  - analog line types, [4-501](#)
  - announcement board backups, [4-504](#)
  - announcements recorded on external devices, [4-504](#)
  - applications, [4-503](#)
  - auxiliary trunk (aux-trunk) types, [4-502](#)
  - barge in capability, [4-503](#)
  - compression rates, [4-505](#)
  - detailed description, [4-501](#)

Recorded Announcement feature, (cont)

- DS1 types, [4-502](#)
- end user procedures, [4-506](#)
- forms, [4-500](#)
- integrated announcement board, [4-502](#)
- integrated announcement boards, [4-504](#)
- interactions
  - Automatic Wakeup, [4-507](#)
  - Call Vectoring, [9-70](#)
  - Intercept Treatment, [4-392](#)
  - QSIG Additional Network Feature Path Replacement (ANF-PR), [12-102](#)
  - Service Observing, [4-551](#)
- multiple integrated announcement boards, [4-505](#)
- single integrated announcement board, [4-504](#)
- types of recorded announcements, [4-501](#)

Recorded Telephone Dictation Access feature, [4-508](#)

interactions

- Attendant Call Waiting, [4-59](#)

redirection criteria and conditions, [4-149](#)

redirection notification, [4-125](#), [4-530](#)

Redirection on No Answer (RONA) feature, [9-116](#) to [9-129](#)

applications, [9-117](#)

auxiliary (AUX) work modes, [9-116](#)

considerations, [9-120](#)

forms, [9-116](#)

home agents, [9-118](#)

interactions

- Abandoned Call Search, [9-121](#)
- agent logout, [9-121](#)
- agent work modes, [9-121](#)
- agents in multiple splits, [9-121](#)
- attendant return call, [9-123](#)
- Auto Available Split (AAS), [9-121](#)
- automatic answering, [9-124](#)
- Basic Call Management System (BCMS), [9-119](#)
- Best Service Routing (BSR), [9-57](#)
- Call Coverage, [9-124](#)
- Call Detail Recording (CDR), [9-125](#)
- Call Forwarding, [9-125](#)
- Call Management System (CMS), [9-119](#)
- Call Pickup, [9-125](#)
- Call Vectoring, [9-70](#), [9-125](#)
- called number displays, [9-125](#)
- calling number displays, [9-125](#)
- CallVisor ASAI, [4-261](#), [9-122](#)
- delay announcements, [9-126](#)
- direct agent calling (DAC), [9-126](#)
- direct department calling (DDC), [9-126](#)
- home agents, [9-126](#)
- Inbound Call Management (ICM), [9-126](#)
- message center/server service, [9-126](#)
- Multiple Call Handling (MCH), [9-109](#), [9-127](#)
- Music on Hold Access, [9-127](#)
- Night Service, [9-127](#)
- Queue Status Indications, [9-127](#)
- queues, [9-127](#)



Redirection on No Answer (RONA) feature, interactions, (cont)  
Reason Codes, [9-115](#)  
Service Observing, [4-551](#)  
stations, [9-127](#)  
VDN of Origin Announcement (VOA), [9-151](#)  
Voice Messaging Systems, [9-124](#)  
Voice Response Integration (VRI), [9-127](#), [9-158](#)  
NATO timers, [9-129](#)  
reports, [9-119](#)  
returning AAS agents to service, [9-120](#)  
ringing call timers, [9-128](#)  
RONA buttons, [6-23](#)  
routing sequences, [9-118](#)  
split lamp indicators, [9-119](#)  
timer descriptions, [9-128](#)  
timer interactions, [9-128](#)  
vector directory numbers (VDN), [9-116](#)  
voice response unit (VRU) applications, [9-117](#)  
wait answer supervision timers (WAST), [9-129](#)  
references to other DEFINITY documentation, [C-1](#)  
referral calls, [4-105](#)  
regulations (for Service Observing), [4-539](#)  
Release buttons, [4-72](#), [4-84](#), [4-97](#), [6-24](#), [9-17](#)  
release link trunks (RLT), [4-602](#), [4-604](#), [7-119](#), [7-252](#), [12-5](#)  
remote access extensions, [4-510](#)  
Remote Access feature, [4-509](#) to [4-514](#)  
Alternate Facility Restriction Levels (AFRL), [4-512](#)  
authorization codes, [4-510](#), [4-512](#)  
barrier code aging, [4-511](#)  
barrier codes, [4-510](#), [4-511](#)  
Class of Restriction (COR), [4-512](#)  
considerations, [4-513](#)  
detailed description, [4-510](#)  
end user procedures, [4-513](#)  
forms, [4-509](#), [5-258](#)  
interactions  
AAR and ARS Partitioning, [8-22](#)  
Abbreviated Dialing (AD), [4-12](#)  
Authorization Codes, [4-513](#)  
Block Collect Call, [4-111](#)  
Call Detail Recording (CDR), [4-221](#)  
Call Park, [4-235](#)  
Class of Restriction (COR), [4-276](#), [4-513](#)  
deluxe paging, [4-420](#)  
Emergency Access to Attendant, [4-321](#)  
Extended Trunk Access (ETA), [12-69](#)  
ISDN-PRI, [4-514](#)  
MF Signaling, [4-443](#)  
Multimedia Call Handling (MMCH), [11-72](#), [11-87](#)  
Night Service, [4-514](#)  
night station service, [4-464](#)  
Ringback Queuing, [4-522](#)  
Tenant Partitioning, [4-577](#)  
Time of Day (TOD) Routing, [8-53](#)  
logoff notifications, [4-513](#)  
security alerts, [4-509](#), [4-510](#)  
Service Observing, [4-542](#)

- Remote Access form, [5-258](#) to [5-262](#)
  - administration commands, [5-259](#)
  - instructions, [5-260](#)
  - security alerts, [5-258](#)
- remote access numbers (RAN), [4-95](#)
- remote administration
  - definitions, [2-14](#)
  - links, [2-15](#)
  - port security, [3-2](#)
  - procedures, [2-16](#)
  - security alerts, [2-14](#)
  - translations, [2-15](#)
  - uniform call distribution (UCD), [2-15](#)
- Remote Call Coverage Table form, [5-263](#)
- remote hold, [12-5](#)
- Remote Home Numbering Plan Area (RHNPA) Table, [8-55](#)
- Remote Home Numbering Plan Area (RHNPA) Table form, [8-76](#)
- remote operation service element (ROSE) services/protocols, [12-79](#)
- remote port security devices (RPSD), [3-2](#), [4-621](#)
- remote service observing, [4-541](#)
- remove commands, [B-8](#)
- remove login command, [2-11](#)
- restore announcements command, [2-24](#)
- restore disk command, [2-34](#)
- restricted line appearances, [9-109](#)
- Restricted/Unrestricted Call Lists (RCL/UCL) feature, [4-515](#) to [4-517](#)
  - authorization check flowchart, [4-515](#)
  - detailed description, [4-515](#)
  - forms, [4-515](#), [5-299](#)
  - interactions, [4-517](#)
- Restriction—Controlled feature, [4-518](#) to [4-519](#)
  - interactions
    - AAR and ARS, [8-18](#)
    - Call Coverage, [4-163](#), [4-519](#)
    - Call Forwarding, [4-519](#)
    - Class of Restriction (COR), [4-274](#), [4-519](#)
    - Code Calling Access, [4-281](#)
    - Do Not Disturb (DND), [10-14](#)
    - Emergency Access to Attendant, [4-321](#)
    - Priority Calling, [4-519](#)
    - Property Management System (PMS) Interface, [10-28](#)
    - Station Hunting, [4-562](#)
    - Transfer—Outgoing Trunk to Outgoing Trunk Transfer (OTTOTT), [4-602](#)
    - uniform call distribution (UCD), [4-519](#)
- Return Call buttons, [6-17](#)
- RHNPA table form, [8-76](#) to [8-77](#)
- ring ping tones, [9-33](#)
- Ringback Queuing feature, [4-520](#) to [4-522](#)
  - interactions
    - AAR and ARS, [4-521](#), [8-18](#)
    - AUDIX, [4-624](#)
    - Automatic Callback (ACB), [4-102](#), [4-521](#)
    - Bridged Call Appearance, [4-125](#), [4-521](#)
    - Call Coverage, [4-162](#), [4-521](#)
    - Call Detail Recording (CDR), [4-221](#)
    - Call Forwarding, [4-228](#)
    - call forwarding—all calls, [4-522](#)
    - Call Pickup, [4-238](#), [4-522](#)

- Ringback Queuing feature, interactions, (cont)
  - Call Vectoring, [9-70](#)
  - CallVisor ASAI, [4-262](#)
  - conference, [4-522](#)
  - deluxe paging, [4-420](#)
  - Hotline Service, [4-364](#)
  - Internal Automatic Answer (IAA), [4-400](#), [4-522](#)
  - Look Ahead Routing (LAR), [8-47](#)
  - Remote Access, [4-522](#)
  - Ringer Cutoff, [4-525](#)
  - Ringling—Abbreviated and Delayed, [4-528](#)
  - Transfer, [4-522](#)
- ringback tones, [12-6](#)
- Ringer Cutoff feature, [4-523](#) to [4-525](#)
  - interactions
    - Attendant Backup Alerting, [4-56](#)
    - Automatic Callback (ACB), [4-524](#)
    - Bridged Call Appearance, [4-125](#), [4-524](#)
    - call forwarding—all calls, [4-524](#)
    - Distinctive Ringing, [4-524](#)
    - Intercom—Automatic, [4-524](#)
    - Intercom—Dial, [4-524](#)
    - Manual Signaling, [4-525](#)
    - Priority Calling, [4-525](#)
    - Ringback Queuing, [4-525](#)
    - Ringling—Abbreviated and Delayed, [4-530](#)
    - Send All Calls (SAC), [4-525](#)
  - Ringer Cutoff buttons, [4-524](#), [6-24](#)
- ringling, [4-526](#)
- ringling appearance preferences, [4-452](#)
- ringling call timers, [9-128](#)
- Ringling—Abbreviated and Delayed feature, [4-526](#) to [4-530](#)
  - call appearances, [4-527](#)
  - considerations, [4-528](#)
  - end user operation, [4-527](#)
  - interactions
    - active station ringling, [4-528](#)
    - Administration without Hardware (AWOH), [4-529](#)
    - Attendant Console, [4-529](#)
    - Automatic Call Distribution (ACD), [4-528](#)
    - Automatic Callback (ACB), [4-528](#)
    - Automatic Circuit Assurance (ACA), [4-528](#)
    - Bridged Call Appearance, [4-125](#)
    - Busy Verification of Terminals and Trunks (Verify), [4-528](#)
    - Call Coverage, [4-529](#)
    - call forwarding—busy/don't answer, [4-529](#)
    - Call Vectoring, [4-529](#)
    - Consult, [4-528](#)
    - data extension calls, [4-529](#)
    - Distinctive Ringing, [4-529](#)
    - Do Not Disturb (DND), [4-529](#)
    - Expert Agent Selection (EAS), [4-529](#)
    - Multiappearance Preselection and Preference, [4-530](#)
    - Off Premises Station, [4-530](#)
    - personal central office lines (PCOL), [4-528](#), [4-530](#)

Ringling—Abbreviated and Delayed feature, interactions, (cont)  
    Priority Calling, [4-528](#)  
    redirection notification, [4-530](#)  
    Ringback Queuing, [4-528](#)  
    Ringer Cutoff, [4-530](#)  
    Security Violation Notification (SVN), [4-528](#)  
    Temporary Bridged Appearance, [4-530](#)  
    Terminal Self Administration (TSA), [4-582](#)  
    Terminating Extension Group (TEG), [4-528](#), [4-530](#)  
    voice mail systems, [4-530](#)  
    Voice Terminal Alerting Options, [4-625](#)  
    world class—BRI terminals, [4-530](#)  
    night console service, [4-528](#)  
    ring options, [4-527](#)  
    ring types, [4-526](#)  
RLT Group form, [7-122](#), [7-252](#) to [7-256](#)  
    administration commands, [7-252](#)  
    hardware requirements, [7-252](#)  
    screens, [7-253](#)  
Room Activated Wakeup with Tones, [10-32](#)  
route pattern, [8-10](#)  
Route Pattern form, [8-67](#) to [8-74](#)  
route-to vector commands, [9-77](#)  
routing  
    economical, [8-50](#)  
    least cost, [8-33](#)  
Routing Extension On Unavailable Voice Synthesis, [10-34](#)  
RS-366 automatic-calling units (ACU), [6-228](#)  
rsvn-halt buttons, [6-24](#)  
Russia  
    country codes, [6-12](#)  
    MF shuttle signaling, [4-262](#), [4-439](#), [7-137](#)  
    Public Network Call Priority, [4-489](#), [4-491](#), [4-493](#)

---

## S

satellite hop limits, [8-47](#)  
satellite switches, [12-67](#)  
satellite TGU/TGE trunks, [7-178](#)  
save announcements  
    command, [2-24](#)  
    screen, [2-20](#)  
save translations  
    Command Completion Status screen, [2-29](#)  
    command operation, [2-19](#)  
    command operations, [2-29](#)  
    command syntax, [2-28](#)  
    list of error codes, [2-30](#)  
    screen, [2-20](#)  
    Terminal Translation Initialization (TTI), [4-590](#)  
Scheduled Emergency Access Summary Report, [10-33](#)  
scheduled maintenance, [2-31](#)  
Scheduled Wakeup Activity Report, [10-32](#)  
Scheduled Wakeup Summary Report, [10-32](#)  
screens  
    display formats, [2-5](#)

- Scroll buttons, [6-24](#)
- second announcements, [9-31](#)
- Second Digit Table form, [5-264](#) to [5-265](#)
- Seconds Before PMS Link Idle Timeout, [10-32](#)
- security alerts
  - Abbreviated Dialing (AD), [4-12](#)
  - Call Detail Recording (CDR), [4-171](#)
  - Call Forwarding, [4-227](#)
  - Extended User Administration of Redirected Calls, [4-337](#)
  - Group Listen, [4-351](#)
  - Personal Computer (PC) Interface, [6-223](#)
  - Remote Access, [4-509](#), [4-510](#), [5-258](#)
  - remote administration, [2-14](#)
  - Service Observing, [4-546](#)
  - Terminal Translation Initialization (TTI), [4-587](#)
  - Transfer—Outgoing Trunk to Outgoing Trunk Transfer (OTTOTT) feature, [4-600](#)
  - Trunk to Trunk Transfer, [4-611](#)
  - Voice Messaging Systems, [4-620](#)
  - Voice Response Integration (VRI), [9-154](#)
- Security Handbook, [3-1](#)
- Security-Related System Parameters form, [5-266](#) to [5-270](#)
  - instructions
    - SVN authorization code violation notification, [5-268](#)
    - SVN remote access violation notification, [5-267](#)
    - minimum station security code length, [5-270](#)
    - SVN login violation notification, [5-267](#)
    - SVN station security code violation notification, [5-269](#)
- Security Violation Notification (SVN) feature, [4-531](#) to [4-536](#)
  - considerations, [4-536](#)
  - dealing with security violations, [4-534](#)
  - detailed description, [4-532](#)
  - enable/disable login IDs, [4-535](#)
  - enable/disable Remote Access, [4-535](#)
  - forms, [4-531](#), [5-266](#)
  - interactions
    - Call Coverage, [4-537](#)
    - Call Detail Recording (CDR), [4-221](#)
    - Call Forwarding, [4-537](#)
    - Call Pickup, [4-537](#)
    - Centralized Attendant Service (CAS), [4-537](#)
    - Distributed Communications System (DCS), [4-537](#)
    - Extended User Administration of Redirected Calls, [4-339](#)
    - Personal Station Access (PSA), [4-479](#)
    - Priority Calling, [4-485](#), [4-537](#)
    - Ringling—Abbreviated and Delayed, [4-528](#)
  - language displays, [4-36](#)
  - list the status of login IDs, [4-535](#)
  - screen, [4-534](#)
  - security violation thresholds and notification, [4-532](#)
  - sequence of events, [4-533](#)
  - SVN-halt buttons, [4-533](#)
  - SVN referral calls with announcements, [4-534](#)
  - system reporting, [4-533](#)
  - system security, [3-2](#)
  - view status of Remote Access, [4-536](#)
- security violations status reports
  - loginIDs added/removed, [2-8](#)
- seizure signals, [7-116](#)

- Send All Calls (SAC) feature, [4-538](#)
  - interactions
    - Administration without Hardware (AWOH), [4-43](#), [4-46](#)
    - Automatic Call Distribution (ACD), [4-538](#)
    - Automatic Callback (ACB), [4-538](#)
    - Call Coverage, [4-538](#)
    - Call Forwarding, [4-231](#)
    - Call Vectoring, [9-70](#)
    - CallVisor ASAI, [4-262](#)
    - direct department calling (DDC), [4-538](#)
    - Group Paging, [4-356](#)
    - Internal Automatic Answer (IAA), [4-400](#), [4-538](#)
    - Malicious Call Trace (MCT), [4-427](#)
    - night console service, [4-538](#)
    - Ringer Cutoff, [4-525](#)
    - Station Hunting, [4-562](#)
    - Terminal Self Administration (TSA), [4-582](#)
    - Terminal Translation Initialization (TTI), [4-590](#)
    - uniform call distribution (UCD), [4-538](#)
    - Whisper Page, [4-640](#)
  - Send All Calls buttons, [4-369](#), [6-24](#)
  - Send All Calls-TEG buttons, [6-25](#)
- Server/INTUITY/PMS Link Integration, [10-27](#)
- service access points (SAP), [1-7](#)
- service marks, [xxix](#)
- Service Observing feature, [4-539](#) to [4-552](#)
  - activation allowed (after observe activated), [4-544](#)
  - activation allowed (at time of activation), [4-544](#)
  - button light indicators, [4-542](#)
  - button restrictions, [4-545](#)
  - conferenced calls, [4-548](#)
  - considerations, [4-547](#)
  - indicators (to observers), [4-542](#)
  - ineligibility, [4-548](#)
  - interactions
    - Add/Remove Skills, [4-551](#)
    - assists, [4-549](#)
    - Attendant Call Waiting, [4-550](#)
    - Automatic Call Distribution (ACD), [9-35](#)
    - Basic Call Management System (BCMS), [4-550](#)
    - Bridged Call Appearance, [4-125](#), [4-550](#)
    - Busy Verification of Terminals and Trunks (Verify), [4-550](#)
    - Call Coverage, [4-550](#)
    - Call Detail Recording (CDR), [4-221](#)
    - Call Management System (CMS), [4-550](#)
    - Call Park, [4-550](#)
    - Call Pickup, [4-550](#)
    - call work codes (CWC), [4-550](#)
    - CallVisor ASAI, [4-262](#), [4-549](#)
    - converse commands, [4-550](#)
    - Data Restriction, [4-304](#)
    - dialed number identification service (DNIS), [4-551](#)
    - direct agent calling (DAC), [4-551](#)
    - Distributed Communications System (DCS), [4-550](#)
    - Expert Agent Selection (EAS), [9-80](#)
    - Facility Test Calls, [4-344](#)

- Service Observing feature, interactions, (cont)
  - Group Paging, [4-356](#)
  - groups, [4-552](#)
  - Hold, [4-551](#)
  - Integrated Directory, [4-550](#)
  - Leave Word Calling (LWC), [4-551](#)
  - Look Ahead Interflow (LAI), [4-551](#)
  - move agents, [4-551](#)
  - Multiple Call Handling (MCH), [4-551](#)
  - Music on Hold Access, [4-551](#)
  - Night Service, [4-551](#)
  - Recorded Announcement, [4-551](#)
  - Redirection on No Answer (RONA), [4-551](#)
  - VDN in a Coverage Path (VICP), [4-552](#)
  - VDN of Origin Announcement (VOA), [4-552](#), [9-151](#)
  - Voice Response Integration (VRI), [9-159](#)
  - Voice Terminal Display, [4-552](#)
  - VuStats, [4-552](#), [9-191](#)
  - Whisper Page, [4-640](#)
  - zip tones, [4-552](#)
- logical agent IDs, [4-541](#)
- multiple observers, [4-548](#)
- observability, [4-547](#)
- observing remotely, [4-541](#)
- regulations, [4-539](#)
- Remote Access, [4-542](#)
- security alerts
  - general security, [4-546](#)
  - remote access security, [4-547](#)
  - VDN call security, [4-546](#)
  - vector initiated security, [4-546](#)
- Service Observing buttons, [4-540](#), [6-25](#)
- skills, [4-547](#)
- splits, [4-547](#)
- transferred calls, [4-549](#)
- trunk calls, [4-548](#)
- vector directory numbers (VDN), [4-539](#), [4-541](#), [4-542](#)
- warning tones, [4-541](#)
- service profile identifiers (SPID), [4-384](#), [6-39](#), [6-223](#), [6-252](#)
- set time command, [2-17](#), [4-19](#)
- Signal buttons, [6-25](#)
- Signaling Group form, [7-106](#) to [7-111](#), [7-122](#), [11-10](#)
  - instructions, [7-107](#)
- silent ringing, [4-526](#)
- simplex system backup, [2-33](#)
- Singapore
  - country codes, [6-11](#)
  - WCBRI terminals, [6-194](#)
- Single Digit Dialing and Mixed Station Numbering feature, [4-553](#) to [4-556](#)
  - forms, [5-99](#)
  - interactions
    - Attendant Display, [4-556](#)
    - AUDIX, [4-624](#)
    - Intercom—Automatic, [4-394](#)
    - Intercom—Dial, [4-396](#)
    - Property Management System (PMS) Interface, [4-556](#)
    - Uniform Dial Plan (UDP), [4-556](#)
    - Voice Terminal Display, [4-556](#), [4-632](#)

- single line voice terminals
  - Bridged Call Appearance, [4-115](#)
  - CallVisor ASAI, [4-262](#)
  - deluxe paging, [4-415](#)
  - Line Lockout, [4-409](#)
  - Manual Originating Line Service, [4-430](#)
  - Ringback Queuing, [4-520](#)
  - soft hold and hard hold, [4-358](#)
- SIT Treatment for Call Classification form, [9-212](#) to [9-213](#)
- skills
  - agent skill level routing, [9-75](#)
  - auxiliary (AUX) work modes, [9-116](#)
  - call handling preferences, [9-34](#)
  - converse skills, [9-153](#)
  - multiple skills, [9-115](#)
  - on request MCH settings, [9-105](#)
  - Reason Codes, [9-115](#)
  - Redirection on No Answer (RONA), [9-116](#), [9-118](#)
  - Service Observing, [4-547](#)
  - settings
    - many forced MCH, [9-107](#)
    - one forced MCH, [9-106](#)
    - one per skill MCH, [9-106](#)
  - vector controlled skills, [9-160](#)
  - voice response units (VRU), [9-153](#)
  - VuStats, [9-190](#)
- soft autohold, [4-361](#)
- soft hold, [4-358](#)
- software defined data networks (SDDN), [4-13](#), [4-15](#), [7-31](#)
- software defined networks (SDN), [12-65](#)
- Spain
  - Administrable Language Displays, [4-20](#)
  - country codes, [6-12](#)
  - Language Translations, [5-193](#)
  - Leave Word Calling (LWC), [4-405](#)
  - MF Espana (MFE), [4-439](#)
  - Public Network Call Priority, [4-489](#), [4-491](#)
  - Voice Terminal Display, [4-626](#)
- speakerphones, [4-349](#), [9-18](#)
- special code displays, [4-36](#)
- special information tones (SIT), [9-212](#)
- special ring tones, [4-244](#)
- speech processing adjuncts, [9-85](#)
- speech synthesizer boards, [10-6](#), [10-12](#)
- splits
  - ACD split agents, [4-369](#)
  - ACD split queues, [9-29](#)
  - ACD splits, [4-132](#), [9-19](#), [9-25](#), [9-35](#), [9-116](#)
  - adjunct controlled, [9-122](#)
  - auxiliary (AUX) work modes, [9-116](#)
  - bridging, [9-19](#)
  - converse splits, [9-150](#), [9-153](#)
  - login split numbers, [9-9](#)
  - multiple splits
    - Automatic Call Distribution (ACD), [9-18](#)
    - queuing, [4-261](#)
    - Redirection on No Answer (RONA), [9-121](#)



- splits, (cont)
  - nonvector controlled splits
    - Agent Call Handling, [9-17](#)
    - Automatic Call Distribution (ACD), [9-29](#)
    - Voice Response Integration (VRI), [9-158](#)
  - on request MCH settings, [9-105](#)
  - queues, [9-32](#)
  - Redirection on No Answer (RONA), [9-116](#), [9-118](#)
  - Service Observing, [4-547](#)
  - settings
    - many forced MCH, [9-107](#)
    - one forced MCH, [9-106](#)
  - split keys, [4-282](#)
  - supervisors, [9-13](#), [9-25](#)
  - vector controlled splits, [9-11](#), [9-36](#), [9-160](#)
  - voice response units (VRU), [9-153](#)
  - VuStats, [9-161](#), [9-182](#)
- ssvn-halt buttons, [6-25](#)
- Start buttons, [4-54](#), [4-97](#)
- start-dial signals, [7-116](#)
- Start keys, [4-362](#)
- Station form, [6-5](#)
  - see also* specific voice terminal types
  - administration commands, [6-4](#)
  - button labels, [6-14](#)
  - field descriptions, [6-28](#)
- Station Hunting feature, [4-557](#) to [4-562](#)
  - characteristics, [4-557](#)
  - examples, [4-558](#)
  - interactions
    - Administration without Hardware (AWOH), [4-43](#), [4-559](#)
    - Attendant Call Waiting, [4-561](#)
    - Automatic Call Distribution (ACD), [4-559](#)
    - Automatic Callback (ACB), [4-560](#)
    - Bridged Call Appearance, [4-560](#)
    - Busy Verification of Terminals and Trunks (Verify), [4-560](#)
    - Call Coverage, [4-560](#)
    - Call Detail Recording (CDR), [4-560](#)
    - Call Forwarding, [4-560](#)
    - Call Park, [4-560](#)
    - Call Pickup, [4-560](#)
    - Call Vectoring, [4-561](#)
    - CallVisor ASAI, [4-559](#)
    - Class of Restriction (COR), [4-561](#)
    - Distributed Communications System (DCS), [4-561](#)
    - Extension Number Portability (ENP), [4-561](#)
    - Hunt Groups, [4-561](#)
    - intercom calls, [4-561](#)
    - Leave Word Calling (LWC), [4-561](#)
    - Multimedia Call Handling (MMCH), [4-561](#), [11-72](#), [11-87](#)
    - Night Service, [4-561](#)
    - outgoing trunk queueing (OTQ), [4-562](#)
    - personal central office lines (PCOL), [4-562](#)
    - Personal Station Access (PSA), [4-562](#)
    - Priority Calling, [4-562](#)
    - Send All Calls (SAC), [4-562](#)
    - Tenant Partitioning, [4-562](#)

- Station Hunting feature, interactions, (cont)
  - Terminal Translation Initialization (TTI), [4-562](#)
  - Terminating Extension Group (TEG), [4-562](#)
  - Uniform Dial Plan (UDP), [4-562](#)
  - voice terminal restrictions, [4-562](#)
- language displays, [4-37](#)
- station hunting chains, [4-557](#)
- Station Security Codes (SSC) feature, [4-563](#) to [4-565](#)
  - changing existing station security codes, [4-563](#)
  - interactions
    - Demand Print, [4-565](#)
    - Extended User Administration of Redirected Calls, [4-565](#)
    - Leave Word Calling (LWC), [4-565](#)
    - Personal Station Access (PSA), [4-565](#)
    - Voice Message Retrieval, [4-565](#)
  - interrupting the command sequence, [4-564](#)
  - logging invalid attempts, [4-564](#)
- station to station calls, [4-43](#), [4-46](#)
- station to station restrictions, *see* Restriction—Controlled
- station type PC/PBXs, [4-109](#)
- stations
  - active station ringing, [4-528](#)
  - analog station recall operation and feature activation, [4-496](#)
  - moves, [4-583](#)
  - Redirection on No Answer (RONA), [9-127](#)
  - set displays, [4-444](#)
  - tracking, [4-71](#)
  - Transfer, [4-598](#)
- statistics, *see* VuStats
- status commands, [B-9](#)
- Status remote-access command, [4-536](#)
- step by step central offices (CO), [7-168](#)
- stored numbers
  - buttons, [6-25](#)
  - display modes, [4-75](#), [4-627](#)
  - language displays, [4-36](#)
- stroke counts
  - Call Management System (CMS), [9-13](#)
  - forced entry, [9-14](#)
  - Multiple Call Handling (MCH), [9-108](#)
- Subnet Trunking feature, [8-48](#) to [8-49](#)
  - forms, [8-48](#), [8-75](#)
  - interactions
    - Wideband Switching, [7-70](#)
- supervisor
  - assist
    - buttons, [6-15](#), [9-13](#)
    - CallVisor ASAI, [4-262](#)
    - Expert Agent Selection (EAS), [9-78](#)
    - Service Observing, [4-549](#)
    - VDN of Origin Announcement (VOA), [9-151](#)
  - split assignments, [9-25](#)
  - supervisory signaling, [7-116](#)
- supplementary service B (SSB) routes, [12-90](#)
- switch communication interface (SCI) links, [4-156](#)
- switch processing elements (SPE), [5-104](#)
- switched data access, [1-7](#)
- Switched Digital International (SDI), [7-31](#)

- switchhook flash, [4-88](#)
- Synchronization Plan form, [7-112](#) to [7-114](#), [7-122](#)
- Sys Ptr Alarm buttons, [6-24](#)
- system access ports, [2-15](#)
- system administration passwords, [4-621](#)
- system administration terminals (SAT)
  - configurations, [2-2](#)
  - Help key, [2-4](#)
  - labeled function keys, [2-5](#)
  - logins, [2-2](#)
  - remote administration, [2-14](#)
- system administrators, [2-1](#)
- system backup for R5r
  - backup command, [2-31](#)
  - error conditions, [2-25](#)
  - operations, [2-24](#)
  - restoring announcements, [2-24](#)
  - save translation command error codes, [2-30](#)
- system backup for R5vs/si
  - errors, [2-21](#)
  - memory cards, [2-19](#)
  - save translations command, [2-19](#)
  - saving and restoring, [2-18](#)
- system failures, [1-6](#)
- system features, [1-7](#)
- system generated tones, [4-301](#)
- system measurements
  - Administered Connections (AC), [4-19](#)
  - Basic Call Management System (BCMS), [9-42](#)
  - Look Ahead Routing (LAR), [8-47](#)
  - Voice Response Integration (VRI), [9-159](#)
- system number lists, [4-4](#), [4-5](#)
- system parameters, [1-7](#)
- system parameters cdr (form), *see* CDR System Parameters form
- System Parameters Country-Options form, [5-271](#) to [5-276](#)
  - administration commands, [5-271](#)
  - instructions, [5-271](#)
- System Parameters Customer-Options form, [5-277](#) to [5-288](#)
  - administration commands, [5-277](#)
  - instructions, [5-277](#)
  - CallVisor ASAI optional features, [5-288](#)
- system parameters duplication (form), *see* Duplication-Related System Parameters form
- system parameters features (form), *see* Feature-Related System Parameters form
- system parameters maintenance (form), *see* Maintenance-Related System Parameters form
- System Parameters Maintenance form, [2-19](#)
- system parameters multifrequency-signaling (form), *see* Multifrequency-Signaling-Related System Parameters form
- System Parameters OCM Call Classification form, [5-289](#) to [5-290](#)
- system parameters security (form), *see* Security-Related System Parameters form
- system port data modules, [6-226](#), [6-248](#)
- System report, [9-119](#)
- System Reset Alert buttons, [6-24](#)
- system resets, [4-144](#)
- system security
  - Authorization Codes, [4-93](#)
  - basic security, [3-2](#)
  - BCS Products Security Handbook, [3-1](#)
  - calling permissions, [5-72](#)
  - Class of Restriction form, [5-72](#)
  - Data Call Setup, [4-292](#)

system security, (cont)  
  disabling Remote Access, [5-259](#)  
  enhanced call transfers (ECT), [3-2](#)  
  Facility Test Calls, [4-343](#)  
  feature related precautions, [3-3](#)  
  History report, [3-2](#)  
  login password aging, [2-11](#)  
  PC/PBX Connection, [4-471](#)  
  permission categories, [2-12](#)  
  physical security, [3-2](#), [3-3](#)  
  Remote Access, [4-509](#), [4-510](#)  
  Security-Related System Parameters form, [5-266](#)  
  Security Violation Notification (SVN), [4-532](#)  
  system administration passwords, [4-621](#)  
  Terminal Translation Initialization (TTI), [4-587](#)  
  toll fraud, [3-1](#)  
  Transfer—Outgoing Trunk to Outgoing Trunk Transfer (OTTOTT), [4-600](#)  
  unauthorized use, [4-621](#)  
System Status report, [9-119](#)  
system technician commands, [7-51](#)  
system time and date, [4-19](#)  
system tone facility test calls, [4-343](#)

---

## T

T.120 calls, [11-30](#)  
T1 connectivity, [9-157](#)  
Take Down Link for Lost Messages, [10-32](#)  
tandem/offnet calls, [4-444](#)  
tandem tie trunk networks (TTTN), [4-221](#), [12-75](#)  
Tandem Trunk Group form, [7-122](#), [7-257](#) to [7-261](#)  
Technical Service Center, [xxxvi](#), [3-2](#)  
Telecommuting Access form, [5-291](#)  
telecommuting employees, [4-474](#)  
telephony services servers, [9-81](#)  
TELESEER, [4-177](#), [4-180](#)  
Temporary Bridged Appearance feature, [4-566](#) to [4-567](#)  
  detailed description, [4-566](#)  
  interactions  
    AUDIX, [4-624](#)  
    Call Coverage, [4-165](#), [4-567](#)  
    Call Detail Recording (CDR), [4-222](#)  
    Call Forwarding, [4-231](#)  
    CallVisor ASAI, [4-262](#)  
    Conference, [4-567](#)  
    Consult, [4-286](#), [4-567](#)  
    Intraflow and Interflow, [9-97](#)  
    Privacy—Manual Exclusion, [4-567](#)  
    Ringing—Abbreviated and Delayed, [4-530](#)  
    Terminating Extension Group (TEG), [4-593](#)  
    Transfer, [4-567](#)  
    Whisper Page, [4-641](#)  
temporary signaling connections (TSC), [4-222](#), [7-98](#), [12-47](#)  
Tenant form, [5-292](#) to [5-294](#)

- Tenant Partitioning feature, [4-568](#) to [4-577](#)
  - access control, [4-571](#)
  - attendant services, [4-571](#)
  - capabilities, [4-570](#)
  - examples, [4-572](#)
  - features to be administered with care to avoid intertenant access, [4-574](#)
  - forms, [4-568](#), [5-243](#), [5-292](#)
  - interactions
    - AAR and ARS, [4-575](#)
    - attendant and attendant group features, [4-575](#)
    - Attendant Backup Alerting, [4-56](#)
    - Attendant Control of Trunk Group Access, [4-575](#)
    - Attendant Crisis Alert, [4-67](#)
    - AUDIX, [4-575](#)
    - Automatic Wakeup, [4-575](#)
    - Bridged Call Appearance, [4-575](#)
    - Call Coverage, [4-165](#), [4-575](#)
    - Call Detail Recording (CDR), [4-576](#)
    - Call Management System (CMS), [4-576](#)
    - Call Pickup, [4-241](#), [4-576](#)
    - Call Vectoring, [4-576](#)
    - Dial Access to Attendant, [4-576](#)
    - Emergency Access to Attendant, [4-576](#)
    - Extended User Administration of Redirected Calls, [4-339](#)
    - Group Paging, [4-356](#)
    - Intercept Treatment, [4-576](#)
    - Listed Directory Numbers (LDN), [4-576](#)
    - Malicious Call Trace (MCT), [4-576](#)
    - Multimedia Call Handling (MMCH), [11-72](#)
    - multiple audio/music sources for vector delays, [4-576](#)
    - Music on Hold Access, [4-577](#)
    - night console service, [4-577](#)
    - night station service, [4-464](#)
    - PC/ISDN, [4-577](#)
    - PC/PBX Connection, [4-577](#)
    - Personal Computer (PC) Interface, [4-577](#)
    - Personal Station Access (PSA), [4-479](#)
    - Remote Access, [4-577](#)
    - Station Hunting, [4-562](#)
    - traffic studies, [4-577](#)
    - trunk answer from any station (TAAS), [4-465](#), [4-577](#)
    - Trunk to Trunk Transfer, [4-612](#)
    - Uniform Dial Plan (UDP), [4-577](#)
    - Whisper Page, [4-641](#)
  - multiple music on hold
    - detailed description, [4-573](#)
    - forms, [4-569](#)
    - types, [4-574](#)
  - network route selection, [4-572](#)
  - partitioning tenants, [4-570](#)
- Term Grp buttons, [6-25](#)
- terminal and trunk restrictions, [4-267](#)
- terminal dialing, [4-19](#)
- terminal emulation, [2-2](#)
- terminal equipment identifiers (TEI), [4-384](#)
- terminal parameters, [6-13](#)

- Terminal Self Administration (TSA) feature, [4-578](#) to [4-582](#)
  - interactions
    - Administered Connections (AC), [4-580](#)
    - Attendant Direct Extension Selection (DXS) with Busy Light Field, [4-580](#)
    - Attendant Intrusion (Call Offer), [4-580](#)
    - Automatic Call Distribution (ACD), [4-580](#)
    - Automatic Callback (ACB), [4-580](#)
    - Automatic Wakeup, [4-580](#)
    - Busy Verification of Terminals and Trunks (Verify), [4-581](#)
    - Call Coverage, [4-581](#)
    - Call Forwarding, [4-581](#)
    - call forwarding—busy/don't answer, [4-581](#)
    - Call Park, [4-581](#)
    - Centralized Attendant Service (CAS), [4-581](#)
    - Class of Service (COS), [4-581](#)
    - Facility Busy Indication, [4-581](#)
    - headsets, [4-581](#)
    - intrusion, [4-581](#)
    - Personal Station Access (PSA), [4-581](#)
    - rering, [4-581](#)
    - Ringling—Abbreviated and Delayed, [4-582](#)
    - Send All Calls (SAC), [4-582](#)
  - security, [4-579](#)
- Terminal Translation Initialization (TTI) feature, [4-583](#) to [4-590](#)
  - analog queue warning ports, [4-587](#)
  - attendants, [4-585](#)
  - considerations, [4-587](#)
  - data modules, [4-585](#)
  - detailed description, [4-583](#)
  - external alert ports, [4-587](#)
  - forms, [4-583](#)
  - interactions
    - Attendant Release Loop Operation, [4-588](#)
    - Automatic Callback (ACB), [4-588](#)
    - Bridged Call Appearance, [4-589](#)
    - Call Coverage, [4-589](#)
    - Call Forwarding, [4-589](#)
    - Call Pickup, [4-589](#)
    - Centralized Attendant Service (CAS), [4-588](#)
    - Customer Provided Equipment (CPE) Alarm, [4-589](#)
    - direct department calling (DDC), [4-589](#)
    - Expert Agent Selection (EAS), [4-589](#)
    - Hunt Groups, [4-589](#)
    - message lights, [4-590](#)
    - night station service, [4-588](#)
    - Personal Station Access (PSA), [4-590](#)
    - save translations, [4-590](#)
    - Send All Calls (SAC), [4-590](#)
    - Station Hunting, [4-562](#)
    - Terminating Extension Group (TEG), [4-590](#)
    - Transfer, [4-590](#)
    - uniform call distribution (UCD), [4-589](#)
  - ISDN—BRI terminals, [4-586](#)
  - merge stations and terminals with TTI ports, [4-584](#)
  - security alerts, [4-587](#)

- Terminal Translation Initialization (TTI) feature, (cont)
  - separation from voice stations, [4-585](#)
  - terminal separation from other terminals, [4-585](#)
  - TTI security codes, [4-583](#)
  - voice/data terminals, [4-586](#)
- Terminating Extension Group (TEG) feature, [4-591](#) to [4-593](#), [5-295](#)
  - interactions
    - Administration without Hardware (AWOH), [4-46](#)
    - Automatic Call Distribution (ACD), [9-39](#)
    - Automatic Callback (ACB), [4-592](#)
    - Bridged Call Appearance, [4-126](#), [4-592](#)
    - Call Coverage, [4-592](#)
    - Call Park, [4-592](#)
    - Call Pickup, [4-241](#)
    - CallVisor ASAI, [4-262](#)
    - deluxe paging, [4-420](#)
    - direct department calling (DDC), [4-592](#)
    - Hunt Groups, [4-372](#)
    - Internal Automatic Answer (IAA), [4-400](#), [4-592](#)
    - ISDN, [7-40](#)
    - Leave Word Calling (LWC), [4-592](#)
    - Multimedia Call Handling (MMCH), [11-72](#), [11-87](#)
    - Privacy—Manual Exclusion, [4-592](#)
    - Ringing—Abbreviated and Delayed, [4-528](#), [4-530](#)
    - Station Hunting, [4-562](#)
    - Temporary Bridged Appearance, [4-593](#)
    - Terminal Translation Initialization (TTI), [4-590](#)
    - uniform call distribution (UCD), [4-592](#)
    - Whisper Page, [4-641](#)
  - TEG buttons, [4-591](#)
- Terminating Extension Group form, [5-295](#) to [5-297](#)
- terminating test lines (TTL), [7-3](#)
- Termination Extension Group (TEG) feature
  - interactions
    - QSIG Supplementary Service - Call Completion, [12-95](#)
  - termination restrictions, [10-11](#)
    - see also Restriction—Controlled
  - test card-mem command, [2-21](#)
  - test display modes, [4-75](#)
  - tie trunk access, [4-222](#), [4-275](#), [12-63](#)
- Tie Trunk Group form, [7-262](#) to [7-267](#)
  - field descriptions, [7-122](#), [7-263](#)
  - hardware requirements, [7-262](#)
  - screens, [7-263](#), [7-269](#)
- time division multiplexing (TDM), [4-449](#)
- Time of Day (TOD) Routing feature, [8-50](#) to [8-53](#)
  - clocked manual override, [8-51](#)
  - detailed description, [8-50](#)
  - form, [8-78](#)
  - forms, [5-206](#), [8-50](#)
  - guidelines, [8-51](#)
  - immediate manual override, [8-51](#)
  - interactions
    - AAR and ARS, [8-52](#)
    - AAR and ARS Partitioning, [8-23](#)
    - Abbreviated Dialing (AD), [8-52](#)
    - attendant extended calls, [8-52](#)

- Time of Day (TOD) Routing feature, interactions, (cont)
  - Authorization Codes, [8-52](#)
  - Bridged Call Appearance, [8-52](#)
  - Call by Call (CBC) Service Selection, [7-48](#)
  - Call Detail Recording (CDR), [8-52](#)
  - Call Forwarding, [8-53](#)
  - Call Vectoring, [9-70](#)
  - Distributed Communications System (DCS), [8-53](#)
  - Individual Attendant Access, [8-53](#)
  - Remote Access, [8-53](#)
  - Uniform Dial Plan (UDP), [8-53](#)
- language displays, [4-38](#)
  - screen, [8-52](#)
  - temporary overrides, [8-51](#)
- time of day coverage table, [4-153](#)
- Time of Day Coverage Table form, [5-298](#)
  - administration commands, [5-298](#)
  - instructions, [5-298](#)
- Time of Day Routing Plan form, [8-78](#) to [8-79](#)
  - administration commands, [8-78](#)
- Time of Scheduled Emergency Access Summary Report, [10-33](#)
- Time of Scheduled Wakeup Activity Report, [10-32](#)
- Time of Scheduled Wakeup Summary Report, [10-32](#)
- time slot facility test calls, [4-343](#)
- timed after call work (ACW)
  - Agent Call Handling, [9-12](#), [9-17](#)
  - Call Vectoring, [9-70](#)
  - CallVisor ASAI, [4-262](#)
  - cancelling, [9-12](#)
  - vector directory numbers (VDN), [9-12](#)
- Timed Reminder and Attendant Timers feature, [4-594](#) to [4-596](#)
  - interactions
    - Attendant Call Waiting, [4-596](#)
    - Attendant Release Loop Operation, [4-89](#)
    - Call Coverage, [4-596](#)
    - Call Vectoring, [9-70](#)
    - CallVisor ASAI, [4-262](#)
    - Centralized Attendant Service (CAS), [4-596](#), [12-10](#)
    - night station service, [4-464](#)
    - Transfer, [4-596](#)
- Timer buttons, [6-25](#)
- timers
  - attendant alerting interval, [4-595](#)
  - attendant no answer timers, [4-595](#)
  - attendant return call timers, [4-594](#)
  - attendant timed reminder of held calls, [4-595](#)
  - DID no answer, [4-442](#)
  - line intercept tone timers, [4-595](#)
  - unanswered DID call timers, [4-594](#)
- TN429 DIOD trunk circuit packs, [7-183](#)
- TN436B DID trunk circuit packs, [7-178](#)
- TN459B DID trunk circuit packs, [7-178](#)
- TN464 DS1 interface circuit packs, [4-467](#), [7-178](#), [7-268](#)
- TN464C DS1 interface circuit packs, [7-34](#), [7-73](#), [7-219](#)
- TN464D DS1 interface circuit packs, [7-150](#), [7-156](#), [7-168](#), [7-193](#), [7-252](#), [7-257](#), [7-262](#)
- TN464F DS1 interface circuit packs, [7-183](#)
- TN556 ISDN-BRI port board circuit packs, [5-19](#), [6-252](#)
- TN556B ISDN-BRI port board circuit packs, [7-198](#)



- TN574 DS1 converter circuit packs, [5-150](#), [5-154](#)
- TN722B DS1 tie trunk circuit packs, [7-73](#), [7-150](#), [7-156](#), [7-252](#), [7-257](#), [7-262](#)
- TN726 data line circuit packs, [5-18](#), [6-234](#)
- TN742 analog line circuit packs, [4-467](#)
- TN744 call classifier circuit packs, [9-212](#)
- TN746 analog line circuit packs, [5-26](#)
- TN746B analog line circuit packs, [4-467](#)
- TN747B CO trunk circuit packs, [7-193](#), [7-246](#), [7-268](#)
- TN750 announcement board circuit packs, [4-502](#), [4-504](#), [5-26](#)
- TN750A announcement board circuit packs, [5-26](#), [6-233](#)
- TN750B announcement board circuit packs, [4-504](#), [5-26](#), [6-233](#)
- TN750C announcement board circuit packs, [4-505](#), [5-26](#), [6-233](#), [9-148](#)
- TN754 digital line circuit packs, [5-18](#), [5-150](#)
- TN758 pooled modem circuit packs, [4-449](#)
- TN760C tie trunk circuit packs, [7-150](#)
- TN760D tie trunk circuit packs, [7-257](#), [7-262](#)
- TN763 auxiliary trunk circuit packs, [4-504](#), [5-26](#)
- TN763C auxiliary trunk circuit packs, [7-174](#)
- TN765 processor interface (PI) circuit packs, [7-34](#), [7-54](#)
- TN767 DS1 interface circuit packs, [4-467](#), [7-34](#), [7-73](#), [7-150](#), [7-156](#), [7-168](#), [7-178](#), [7-219](#), [7-252](#), [7-257](#), [7-262](#), [7-268](#)
- TN769 analog line circuit packs, [4-467](#)
- TN771D maintenance/test circuit packs, [7-10](#)
- TN777B netcon circuit packs, [2-21](#)
- TN778 packet control (PACCON) circuit packs, [7-34](#), [7-198](#), [7-219](#)
- TN780 tone clock circuit packs, [7-198](#), [7-220](#)
- TN1654 DS1 converter circuit packs, [5-154](#), [5-155](#), [5-156](#), [5-157](#)
- TN1655 packet interface circuit packs, [7-34](#), [7-198](#), [7-220](#)
- TN2139 DID trunk circuit packs, [7-178](#)
- TN2146 DID trunk circuit packs, [7-178](#)
- TN2182 tone clock circuit packs, [7-198](#), [7-220](#)
- TN2183 analog line circuit packs, [4-504](#), [5-26](#)
- TN2184 DIOD trunk circuit packs, [7-178](#)
- TN2198 ISDN–BRI port board circuit packs, [6-252](#)
- TN2199 trunk circuit packs, [7-178](#)
- TN753 DID trunk circuit packs, [7-178](#)
- TN429D CO trunk circuit pack, [4-374](#)
- TN725B circuit packs, [10-34](#)
- TN750B circuit packs, [10-33](#)
- TN750C circuit packs, [10-33](#)
- TN763D circuit packs, [10-33](#)
- Toll Analysis form, [5-299](#) to [5-302](#)
  - administration commands, [5-299](#)
  - default toll list assignments, [5-302](#)
  - implementation notes, [5-302](#)
  - instructions, [5-300](#)
- toll fraud, [3-1](#), [4-213](#), [4-620](#), [8-50](#)
- toll restrictions, [8-19](#)
- tones
  - administrable ringing patterns, [4-480](#)
  - audible ringback, [4-244](#), [12-6](#)
  - call identification, [12-6](#)
  - call progress, [4-155](#), [4-642](#), [4-643](#)
  - call waiting, [4-643](#), [9-33](#)
  - call waiting ringback, [4-483](#)
  - incoming call ID, [9-18](#)
  - intercept, [10-11](#)
  - priority call waiting, [4-244](#)
  - quick burst, [4-244](#)
  - ring ping, [9-33](#)

- tones, (cont)
  - siren type, [4-390](#)
  - special information tones (SIT), [9-212](#)
  - special ringing, [4-244](#)
  - system generated, [4-301](#)
  - system tone facility test calls, [4-343](#)
  - warning, [4-541](#)
  - zip, [9-18](#), [9-33](#), [9-77](#)
- total restrictions, see Restriction—Controlled
- touch tone dialing
  - Facility Test Calls, [4-344](#)
  - Integrated Directory, [4-381](#)
  - Voice Response Integration (VRI), [9-159](#)
- trademarks, [xxix](#)
- traffic measurements, [7-48](#)
- traffic studies, [4-577](#)
- Transfer feature, [4-597](#)
  - enhanced call transfers (ECT), [3-2](#)
  - interactions
    - Administration without Hardware (AWOH), [4-43](#), [4-47](#), [4-48](#)
    - Agent Call Handling, [9-20](#)
    - AUDIX, [4-623](#)
    - Automated Attendant, [4-99](#)
    - Automatic Call Distribution (ACD), [9-39](#)
    - Automatic Callback (ACB), [4-102](#)
    - Bridged Call Appearance, [4-126](#)
    - Busy Verification of Terminals and Trunks (Verify), [4-134](#)
    - Call Charge Information, [4-143](#)
    - Call Coverage, [4-165](#)
    - Call Detail Recording (CDR), [4-222](#)
    - Call Forwarding, [4-231](#)
    - Call Pickup, [4-241](#)
    - Call Prompting, [9-62](#)
    - Call Vectoring, [9-70](#)
    - CallVisor ASAI, [4-259](#)
    - Class of Restriction (COR), [4-275](#)
    - Code Calling Access, [4-281](#)
    - Conference—Attendant, [4-597](#)
    - deluxe paging, [4-421](#)
    - Flexible Billing, [4-347](#)
    - Group Paging, [4-356](#)
    - Internal Automatic Answer (IAA), [4-400](#), [4-597](#)
    - ISDN, [7-40](#)
    - ISDN—BRI, [4-597](#)
    - Malicious Call Trace (MCT), [4-428](#)
    - QSIG, [4-598](#)
    - QSIG Call Forwarding (Diversion), [12-100](#)
    - QSIG Supplementary Service - Call Completion, [12-94](#)
    - Ringback Queuing, [4-522](#)
    - stations, [4-598](#)
    - Temporary Bridged Appearance, [4-567](#)
    - Terminal Translation Initialization (TTI), [4-590](#)
    - Timed Reminder and Attendant Timers, [4-596](#)
    - VDN of Origin Announcement (VOA), [9-151](#)
    - Voice Response Integration (VRI), [9-159](#)
    - Whisper Page, [4-641](#)
- Transfer buttons, [4-88](#), [4-233](#), [4-283](#), [4-285](#), [4-351](#), [4-496](#)

- Transfer—Outgoing Trunk to Outgoing Trunk Transfer (OTTOTT) feature, [4-599](#) to [4-602](#)
  - interactions
    - DCS trunk turnarounds, [4-601](#)
    - incoming disconnect supervision, [4-601](#)
    - personal central office lines (PCOL), [4-601](#)
    - QSIG, [4-601](#)
    - release link trunks (RLT), [4-602](#)
    - Restriction—Controlled, [4-602](#)
    - Trunk to Trunk Transfer, [4-602](#)
    - trunks groups, [4-602](#)
  - security alerts, [4-600](#)
- transit network selections, [7-45](#)
- transition reference, [A-1](#)
- translations
  - backing up, [2-24](#)
  - Command Completion Status screen, [2-30](#)
  - entry order, [1-6](#)
  - remote administration, [2-15](#)
  - restoring, [2-24](#)
  - saving, [1-6](#), [2-24](#)
  - saving data, [2-19](#)
- Trouble Tracker, [4-51](#)
- trouble tracking systems, [4-51](#)
- trunk access codes (TAC)
  - QSIG Additional Network Feature Path Replacement (ANF-PR), [12-102](#)
  - QSIG Additional Network Feature—Transit Counter (ANF-TC), [12-102](#)
- Trunk Flash feature, [4-603](#) to [4-606](#)
  - interactions
    - Abandoned Call Search, [9-3](#)
    - Trunk Flash buttons, [4-605](#)
- Trunk Group Administration features
  - Automatic Transmission Measurement System (ATMS), [7-2](#)
  - Call by Call (CBC) Service Selection, [7-42](#)
  - Digital Multiplexed Interface (DMI), [7-19](#)
  - DS1 Trunk Service, [7-11](#)
  - Facility and Nonfacility Associated Signaling (FAS and NFAS), [7-49](#)
  - Integrated Channel Service Unit (ICSU), [7-21](#)
  - ISDN, [7-25](#)
  - Wideband Switching, [7-56](#)
- Trunk Group Busy/Warning Indicators to Attendant feature, [4-607](#)
  - interactions
    - Attendant Control of Trunk Group Access, [4-64](#)
- Trunk Group Select buttons, [4-54](#), [4-63](#), [12-29](#)
- trunk groups
  - AAR and ARS restrictions, [8-18](#)
  - Administered Connections (AC), [4-19](#)
  - advanced private line termination (APLT), [7-120](#), [7-156](#)
  - analog tie trunks, [7-119](#)
  - answer supervision timers, [4-76](#)
  - attendant control, [4-62](#)
  - Automatic Incoming Call Display, [4-109](#)
  - busy trunk indicators, [4-607](#)
  - busy verification, [4-132](#)
  - characteristics, [7-116](#)
  - Code Calling Access restrictions, [4-281](#)
  - controlled access, [4-64](#)
  - digital public network trunks, [7-121](#)
  - digital tie trunks, [7-120](#)
  - Facility Test Calls, [4-343](#)

- trunk groups, (cont)
    - faulty trunk identification, [4-610](#)
    - general information, [7-115](#)
    - Group Paging, [4-356](#)
    - malfunctions, [4-104](#)
    - private network trunks, [7-119](#)
    - public network trunks, [7-120](#), [7-121](#)
    - release link trunks (RLT), [7-119](#)
    - Service Observing trunk, [4-552](#)
    - supervisory signaling, [7-116](#)
    - test calls, [4-130](#)
    - threshold values, [4-105](#)
    - Transfer—Outgoing Trunk to Outgoing Trunk Transfer (OTTOTT), [4-602](#)
    - transmission of address, [7-118](#)
    - transmission of alerting, [7-118](#)
    - trunk access codes (TAC), [4-130](#), [4-428](#)
    - types, [7-115](#)
    - VuStats, [9-188](#)
    - warning thresholds, [4-607](#)
  - Trunk Hundreds Select buttons, [4-63](#), [4-72](#), [4-607](#), [12-29](#), [12-52](#)
  - Trunk Identification by Attendant feature, [4-609](#) to [4-610](#)
    - interactions
      - Attendant Display, [4-610](#)
      - Busy Verification of Terminals and Trunks (Verify), [4-610](#)
      - DCS Busy Verification of Terminals and Trunks, [12-61](#)
      - Hold, [4-610](#)
      - Voice Terminal Display, [4-610](#)
    - Trunk ID buttons, [4-609](#), [6-25](#), [12-61](#)
  - Trunk to Trunk Transfer feature, [4-611](#)
    - interactions
      - Call Detail Recording (CDR), [4-223](#)
      - Call Vectoring, [4-612](#)
      - Conference—Attendant, [4-283](#)
      - Conference—Terminal, [4-285](#)
      - Look Ahead Interflow (LAI), [9-103](#)
      - Privacy—Attendant Lockout, [4-486](#), [4-612](#)
      - Tenant Partitioning, [4-612](#)
      - Transfer—Outgoing Trunk to Outgoing Trunk Transfer (OTTOTT), [4-602](#)
    - security alert, [4-611](#)
  - trunk turnarounds, [4-599](#)
  - trunking facilities, [8-16](#)
  - type of number (TON) encodings, [8-58](#)
- 

## U

- Unanswered DID Call Timer (seconds), [5-135](#)
- unavailable/failed seconds (UAS/FS), [7-23](#)
- uniform call distribution (UCD)
  - Attendant Call Waiting, [4-59](#)
  - Automatic Call Distribution (ACD), [9-28](#)
  - busy verification, [4-132](#)
  - Call Coverage, [4-164](#)
  - Data Call Setup, [4-297](#)
  - DCS Alphanumeric Display for Terminals, [12-60](#)
  - Internal Automatic Answer (IAA), [4-400](#)
  - QSIG Supplementary Service - Call Completion, [12-95](#)

- uniform call distribution (UCD), (cont)
  - remote administration, [2-15](#)
  - Restriction—Controlled, [4-519](#)
  - Send All Calls (SAC), [4-538](#)
  - Terminal Translation Initialization (TTI), [4-589](#)
  - Terminating Extension Group (TEG), [4-592](#)
  - test calls, [4-130](#)
  - Voice Response Integration (VRI), [9-159](#)
  - Whisper Page, [4-641](#)
- Uniform Dial Plan (UDP) feature, [12-103](#) to [12-108](#)
  - considerations, [12-107](#)
  - detailed description, [12-104](#)
  - examples, [12-106](#)
  - forms, [5-263](#), [12-103](#)
  - interactions
    - AAR and ARS, [12-108](#)
    - AAR and ARS Partitioning, [8-23](#)
    - Attendant Control of Trunk Group Access, [4-65](#)
    - Call Detail Recording (CDR), [4-223](#)
    - DCS Attendant Control of Trunk Group Access, [12-61](#)
    - Dial Plan, [12-108](#)
    - DID trunk groups, [12-108](#)
    - Distributed Communications System (DCS), [12-108](#)
    - Extension Number Portability (ENP), [12-108](#)
    - Single Digit Dialing and Mixed Station Numbering, [4-556](#)
    - Station Hunting, [4-562](#)
    - Tenant Partitioning, [4-577](#)
    - Time of Day (TOD) Routing, [8-53](#)
  - UDP codes, [12-105](#)
- Uniform Dial Plan form, [12-121](#) to [12-122](#)
- United Kingdom
  - country codes, [6-12](#)
  - Trunk Flash, [4-603](#)
- Universal Call ID (UCID) feature, [9-130](#)
  - Administering UCID, [9-140](#)
  - Before you administer UCID, [9-139](#)
  - creating, [9-131](#)
  - interactions
    - Distributed Communications System (DCS), [9-139](#)
    - Remote AUDIX, [9-139](#)
  - purpose, [9-130](#)
  - Tandem Calls, [9-139](#)
  - testing, [9-144](#)
  - tracking
    - complex conference, [9-134](#)
    - CONVERSANT before DEFINITY, [9-138](#)
    - DEFINITY before CONVERSANT, [9-134](#), [9-136](#)
    - incoming trunk calls, [9-133](#)
    - outgoing trunk calls, [9-133](#)
    - simple transfer or conference, [9-133](#)
    - station-to-station calls, [9-132](#)
  - transmitting, [9-131](#)
  - Troubleshooting, [9-144](#)
- universal digital signal level 1 boards (UDS1), [7-59](#)
- unlock functions, [4-615](#)

- usage allocation
    - enhancements, [7-100](#)
    - ISDN–PRI messages and information elements, [7-45](#)
    - usage allocation plans (UAP), [7-45](#)
  - user customized language translations, [5-193](#)
  - User Defined Adjunct Names form, [5-303](#)
  - user defined language displays, [4-20](#)
- 

## V

- VDN in a Coverage Path (VICP) feature, [9-145](#)
  - interactions
    - Call Coverage, [4-156](#)
    - Service Observing, [4-552](#)
- VDN of Origin Announcement (VOA) feature, [9-146](#) to [9-151](#)
  - auxiliary trunks (aux-trunks), [9-148](#)
  - considerations, [9-148](#)
  - detailed description, [9-146](#)
  - distribution, [9-151](#)
  - forms, [9-146](#)
  - interactions
    - Agent Call Handling, [9-149](#)
    - Auto Available Split (AAS), [9-149](#)
    - Automatic Wakeup, [9-150](#)
    - Call Coverage, [9-150](#)
    - Call Forwarding, [9-149](#)
    - Call Pickup, [9-149](#)
    - CallVisor ASAI adjunct routing, [9-149](#)
    - Conference—Terminal, [9-149](#)
    - converse splits, [9-150](#)
    - Data Restriction, [9-150](#)
    - direct agent calling (DAC), [9-150](#)
    - Expert Agent Selection (EAS), [9-150](#)
    - Hold, [9-150](#)
    - home agents, [9-150](#)
    - Hunt Groups, [9-150](#)
    - Look Ahead Interflow (LAI), [9-151](#)
    - Redirection on No Answer (RONA), [9-151](#)
    - Service Observing, [4-552](#), [9-151](#)
    - supervisor assists, [9-151](#)
    - Transfer, [9-151](#)
  - multiple announcement boards, [9-148](#)
  - setting up VOAs, [9-147](#)
  - vector directory number (VDN) override, [9-147](#)
  - VOA Repeat buttons, [6-26](#), [9-147](#)
- vector commands
  - Call Prompting, [9-60](#)
  - Call Vectoring, [9-63](#)
  - Inbound Call Management (ICM), [9-87](#)
- vector controlled splits, *see under* splits
- Vector Directory Number form, [9-214](#) to [9-218](#)
  - administration commands, [9-214](#)
  - implementation notes—list, [9-217](#)
  - instructions, [9-214](#)
  - screen—add/change, [9-217](#)
  - screen—list, [9-217](#)

- vector directory numbers (VDN)
  - Agent Call Handling override, [9-21](#)
  - DCS Automatic Callback (ACB), [12-61](#)
  - DXS lights, [4-68](#)
  - Leave Word Calling (LWC), [4-408](#)
  - Redirection on No Answer (RONA), [9-116](#)
  - Service Observing, [4-539](#), [4-541](#), [4-542](#)
  - timed after call work (ACW), [9-12](#)
  - VDN reports, [9-119](#)
  - VOA override, [9-147](#)
  - Voice Response Integration (VRI), [9-159](#)
  - VuStats data types, [9-186](#)
- Vector Routing Table form, [9-219](#) to [9-220](#)
- vector routing tables, [9-219](#)
- vector directory numbers (VDN)
  - QSIG Supplementary Service - Call Completion, [12-95](#)
- video conferencing, [6-228](#), [7-61](#), [11-31](#)
- Videophone 2500, [4-127](#)
- virtual buttons, [6-192](#)
- visual alerting, [4-66](#)
- Visually Impaired Attendant Service (VIAS) feature, [4-613](#) to [4-614](#)
  - interactions
    - Auto Start and Don't Split, [4-97](#), [4-614](#)
    - Automatic Circuit Assurance (ACA), [4-106](#)
    - Malicious Call Trace (MCT), [4-426](#)
  - VIAS Activation/Deactivation buttons, [4-613](#)
  - VIAS attendant buttons, [4-613](#)
  - voice feedback languages, [4-613](#)
- voice mail security, [4-621](#)
- voice mail systems, [4-530](#)
- voice mailbox passwords, [4-621](#)
- Voice Message Retrieval feature, [4-615](#) to [4-617](#)
  - interactions
    - AUDIX, [4-616](#)
    - Automatic Circuit Assurance (ACA), [4-107](#)
    - Bridged Call Appearance, [4-127](#), [4-617](#)
    - CallVisor ASAI, [4-262](#)
    - Enhanced Voice Terminal Display, [4-325](#)
    - Leave Word Calling (LWC), [4-617](#)
    - Station Security Codes (SSC), [4-565](#)
  - modes, [4-627](#)
- Voice Messaging Systems feature, [4-618](#) to [4-622](#)
  - considerations, [4-621](#)
  - DCS configurations, [4-620](#)
  - forms, [4-619](#)
  - interactions, [4-622](#)
    - Redirection on No Answer (RONA), [9-124](#)
    - Voice Response Integration (VRI), [9-156](#)
  - security alerts, [4-620](#)
  - supported systems, [4-618](#)
- voice paging, [4-127](#)
- voice prompting
  - with Room Activated with Tones off, [10-6](#)
  - with Room Activated with Tones on, [10-6](#)

Voice Response Integration (VRI) feature, [9-152](#) to [9-160](#)  
  audiotex applications, [9-152](#)  
  CONVERSANT voice information system (CVIS), [9-152](#)  
  converse-on vector command, [9-152](#)  
  detailed description, [9-153](#)  
  dial ahead digits, [9-154](#)  
  forms, [9-153](#)  
  interactions  
    Agent Call Handling, [9-21](#)  
    agents, [9-155](#)  
    answer supervision, [9-155](#)  
    AUDIX, [9-159](#)  
    Auto Available Split (AAS), [9-156](#)  
    automatic answering, [9-156](#)  
    Basic Call Management System (BCMS), [9-156](#)  
    Call Detail Recording (CDR), [9-156](#)  
    Call Management System (CMS), [9-156](#)  
    Call Park, [9-156](#)  
    Call Pickup, [9-156](#)  
    Call Prompting, [9-154](#)  
    CallVisor ASAI, [9-155](#)  
    Class of Restriction (COR), [9-156](#)  
    Conference—Terminal, [9-156](#)  
    direct department calling (DDC), [9-157](#)  
    Distributed Communications System (DCS), [9-157](#)  
    Expert Agent Selection (EAS), [9-157](#)  
    Hold, [9-157](#)  
    Hold—Automatic, [9-157](#)  
    Hunt Groups, [9-157](#)  
    intraswitch CDR, [9-157](#)  
    ISDN, [9-157](#)  
    Look Ahead Interflow (LAI), [9-157](#)  
    message centers, [9-158](#)  
    Misoperation Handling, [4-448](#)  
    Music on Hold Access, [9-158](#)  
    nonvector controlled splits, [9-158](#)  
    queuing, [9-158](#)  
    R2 multifrequency compelled (MFC) signaling, [9-158](#)  
    recorded announcements, [9-158](#)  
    Redirection on No Answer (RONA), [9-127](#), [9-158](#)  
    Service Observing, [9-159](#)  
    system measurements, [9-159](#)  
    T1 connectivity, [9-157](#)  
    touch tone dialing, [9-159](#)  
    Transfer, [9-159](#)  
    uniform call distribution (UCD), [9-159](#)  
    VDN display override, [9-159](#)  
    vector controlled splits, [9-160](#)  
    Voice Messaging Systems, [9-156](#)  
  queues, [9-152](#)  
  security alerts, [9-154](#)  
  voice response units (VRU), [9-152](#)



- voice response units (VRU)
  - failures, [9-117](#)
  - Inbound Call Management (ICM), [9-83](#)
  - Redirection on No Answer (RONA), [9-117](#)
  - Voice Response Integration (VRI), [9-152](#)
  - voice terminals, [6-47](#)
- voice synthesis circuit packs, [4-405](#)
- voice synthesizers, [4-92](#), [10-10](#)
- Voice Terminal Alerting Options feature, [4-625](#)
- voice terminal dialing
  - Administration without Hardware (AWOH), [4-47](#)
  - Data Call Setup, [4-294](#), [4-295](#)
  - Data Only Off Premises Extensions, [4-305](#), [4-306](#)
- Voice Terminal Display feature, [4-626](#) to [4-632](#)
  - button assignments, [4-626](#)
  - call related information, [4-628](#)
  - considerations, [4-629](#)
  - detailed description, [4-626](#)
  - display examples, [4-630](#)
  - forms, [4-626](#)
  - interactions
    - AAR and ARS, [8-19](#)
    - Automatic Call Distribution (ACD), [9-39](#)
    - Automatic Callback (ACB), [4-103](#)
    - Automatic Incoming Call Display, [4-109](#)
    - Automatic Wakeup, [10-10](#)
    - Block Collect Call, [4-111](#)
    - Bridged Call Appearance, [4-117](#), [4-632](#)
    - DCS Multiappearance Conference/Transfer, [12-64](#)
    - Enhanced Voice Terminal Display, [4-325](#)
    - Expert Agent Selection (EAS), [9-79](#)
    - Individual Attendant Access, [4-378](#)
    - Integrated Directory, [4-381](#)
    - ISDN, [7-40](#)
    - ISDN-BRI, [4-389](#)
    - Last Number Dialed, [4-632](#)
    - Multimedia Call Handling (MMCH), [11-72](#), [11-88](#)
    - QSIG Additional Network Feature Path Replacement (ANF-PR), [12-102](#)
    - Queue Status Indications, [9-111](#)
    - Service Observing, [4-552](#)
    - Single Digit Dialing and Mixed Station Numbering, [4-556](#), [4-632](#)
    - Trunk Identification by Attendant, [4-610](#)
- voice terminals
  - administration commands, [6-4](#)
  - administration order, [6-4](#)
  - auto answer terminals, [9-23](#)
  - busy verification, [4-130](#)
  - button assignments, [9-17](#)
  - digital display, [9-161](#)
  - duplicate command, [1-7](#), [B-6](#)
  - enhanced terminal administration (ETA), [6-5](#)
  - feature button descriptions, [6-14](#)
  - inward restriction overrides, [4-60](#)
  - ISDN call identification displays, [7-29](#)
  - language display options, [4-20](#)
  - lock functions, [4-407](#), [4-615](#)
  - multiappearance, [4-113](#)
  - origination restrictions, [4-134](#)

- voice terminals, (cont)
  - power failure transfer terminals, [4-482](#)
  - preprinted labels, [1-5](#)
  - restrictions, [4-276](#), [4-641](#)
  - termination restrictions, [4-134](#)
  - test calls, [4-130](#)
  - Trunk Flash, [4-603](#)
  - unlock functions, [4-615](#)
- VuStats Display Format form, [9-221](#) to [9-234](#)
  - administration commands, [9-221](#)
  - instructions, [9-221](#)
  - required and allowed field tables, [9-227](#)
  - screens, [9-225](#)
- VuStats feature, [9-161](#) to [9-191](#)
  - button light flashes, [9-171](#)
  - CALLMASTER display, [9-162](#)
  - considerations, [9-189](#)
  - data types, [9-170](#)
    - agents and agent extensions, [9-173](#)
    - split data, [9-182](#)
    - tables, [9-173](#)
    - trunk groups, [9-188](#)
    - vector directory numbers (VDN), [9-186](#)
  - detailed description, [9-170](#)
  - display formats, [9-171](#)
    - split data types, [9-231](#)
    - trunk group data types, [9-233](#), [9-234](#)
    - VDN data types, [9-233](#)
  - display intervals, [9-169](#)
  - display linking, [9-171](#)
  - forms, [9-163](#)
  - how information appears, [9-172](#)
  - information displayed, [9-170](#)
  - interactions
    - Add/Remove Skills, [9-5](#), [9-6](#)
    - Basic Call Management System (BCMS), [9-190](#)
    - Call Management System (CMS), [9-190](#)
    - Call Prompting, [9-190](#)
    - call work codes (CWC), [9-190](#)
    - changing skills, [9-190](#)
    - Enhanced Voice Terminal Display, [4-326](#)
    - Expert Agent Selection (EAS), [9-80](#)
    - Expert Agent Selection-preference handling distribution (EAS-PHD), [9-190](#)
    - Integrated Directory, [9-190](#)
    - Queue Status Indications, [9-191](#)
    - Reason Codes, [9-191](#)
    - Service Observing, [4-552](#), [9-191](#)
- Next buttons, [9-172](#)
- statistical periods, [9-171](#)
- text labels, [9-171](#)
- thresholds, [9-171](#)
- VuStats # buttons, [6-26](#)
- VuStats feature buttons, [9-165](#)
- when information updates, [9-172](#)

---

## W

- wait answer supervision timers (WAST), [4-262](#), [5-137](#), [9-129](#)
- Wakeup Activity reports, [10-9](#)
- wakeup messages extensions, [10-7](#)
- Wakeup Summary reports, [10-9](#)
- Warn (warning) lights, [4-72](#), [4-607](#)
- WATS Trunk Group form, [7-268](#) to [7-272](#)
  - field descriptions, [7-122](#)
  - hardware requirements, [7-268](#)
  - implementation notes, [7-269](#)
- Whisper Page feature, [4-633](#) to [4-641](#)
  - interactions
    - Attendant Auto Manual Splitting, [4-635](#)
    - Attendant Display, [4-635](#)
    - Attendant Intrusion (Call Offer), [4-636](#)
    - Attendant Override of Diversion Features, [4-636](#)
    - Automatic Incoming Call Display, [4-636](#)
    - Bridged Call Appearance, [4-637](#)
    - Busy Verification of Terminals and Trunks (Verify), [4-638](#)
    - Call Pickup, [4-638](#)
    - calling number displays, [4-638](#)
    - character voice terminal displays, [4-638](#)
    - Class of Restriction (COR), [4-638](#)
    - Conference—Attendant, [4-638](#)
    - Conference—Terminal, [4-638](#)
    - Data Privacy, [4-638](#)
    - data/time terminal displays, [4-638](#)
    - direct agent calling (DAC) via logical agent ID, [4-639](#)
    - direct department calling (DDC), [4-639](#)
    - Distributed Communications System (DCS), [4-639](#)
    - Do Not Disturb (DND), [4-639](#)
    - elapsed timers, [4-639](#)
    - electronic tandem networks (ETN), [4-639](#)
    - flexible language displays, [4-639](#)
    - Go to Cover, [4-639](#)
    - Group Listen, [4-639](#)
    - Group Paging, [4-639](#)
    - Hunt Groups, [4-639](#)
    - Last Number Dialed, [4-640](#)
    - multilanguage displays, [4-640](#)
    - Priority Calling, [4-640](#)
    - Privacy—Attendant Lockout, [4-640](#)
    - QSIG, [4-640](#)
    - Send All Calls (SAC), [4-640](#)
    - Service Observing, [4-640](#)
    - Temporary Bridged Appearance, [4-641](#)
    - Tenant Partitioning, [4-641](#)
    - Terminating Extension Group (TEG), [4-641](#)
    - Transfer, [4-641](#)
    - uniform call distribution (UCD), [4-641](#)
    - voice terminal restrictions, [4-641](#)

- Whisper Page feature, (cont)
  - station buttons, [4-634](#)
  - whisp-act buttons, [4-634](#)
  - whisp-anbk buttons, [4-634](#)
  - whisp-off buttons, [4-634](#)
- Whisper Page Off buttons, [4-635](#)
- wide area telecommunications service (WATS), [7-198](#), [7-219](#), [7-268](#)
- wideband access endpoints (WAE), [7-72](#)
- Wideband Switching feature, [7-56](#) to [7-70](#)
  - applications, [7-56](#)
  - blocking prevention, [7-67](#)
  - channel allocation, [7-57](#)
  - channel service units (CSU), [7-60](#)
  - considerations, [7-68](#)
  - data backup connections, [7-61](#)
  - data service units (DSU), [7-60](#)
  - detailed description, [7-56](#)
  - direction of trunk/hunting within facilities, [7-62](#)
  - endpoint applications, [7-58](#)
  - facility lists, [7-62](#)
  - forms, [7-56](#)
  - glare prevention and resolution, [7-66](#)
  - H0 channels, [7-64](#)
  - H11 channels, [7-63](#)
  - H12 channels, [7-64](#)
  - high speed video conferencing, [7-61](#)
  - interactions
    - Administered Connections (AC), [7-68](#)
    - Automatic Circuit Assurance (ACA), [4-107](#), [7-68](#)
    - Basic Call Management System (BCMS), [7-69](#)
    - Call Coverage, [7-69](#)
    - Call Detail Recording (CDR), [7-69](#)
    - Call Forwarding, [7-69](#)
    - Call Management System (CMS), [7-69](#)
    - Call Vectoring, [7-69](#)
    - Class of Restriction (COR), [7-69](#)
    - Class of Service (COS), [7-69](#)
    - Facility and Nonfacility Associated Signaling (FAS and NFAS), [7-69](#)
    - Facility Busy Indication, [7-69](#)
    - Facility Test Calls, [7-69](#)
    - Generalized Route Selection (GRS), [7-70](#)
    - ISDN-BRI, [7-70](#)
    - Subnet Trunking, [7-70](#)
- ISDN-PRI terminal adapters, [7-58](#)
- ISDN-PRI trunk groups and channel allocations, [7-62](#)
- line side (T1 or E1) ISDN-PRI facilities, [7-59](#), [7-60](#)
- N x DS0 channels, [7-65](#)
- networking, [7-61](#)
- nonsignaling configurations, [7-59](#)
- port network (PN) preferential trunk routing, [7-62](#)
- PRI endpoints (PE), [7-59](#), [7-102](#)
- primary data connectivity, [7-61](#)
- scheduled batch processing, [7-61](#)
- typical uses, [7-57](#)
- universal digital signal level 1 boards (UDS1), [7-59](#)
- wideband access endpoints (WAE), [7-60](#)
- wink start dial repeating, [7-120](#)
- Work Code buttons, [6-26](#)

work modes

- buttons, [9-73](#)
- Expert Agent Selection (EAS), [9-78](#)
- Multiple Call Handling (MCH), [9-107](#)

workstation arrangements

- Constellation voice/data terminals, [6-158](#)
- PC Interface, [6-220](#)
- PC/PBX Connection, [4-471](#)
- PC with 7400D series terminals, [6-153](#)

world class attendants, [4-44](#)

World Class Tone Detection (WCTD) feature, [4-642](#)

interactions

- Data Call Setup, [4-297](#)

World Class Tone Generation feature, [4-643](#)

world class-BRI data modules, [6-226](#), [6-255](#)

world class-BRI terminals

- CallVisor ASAI, [4-263](#)
- country requirements, [6-194](#)
- feature interactions, [6-197](#)
- Ringling—Abbreviated and Delayed, [4-530](#)
- screens, [6-195](#)

---

## X

X.25 data modules, [6-226](#), [6-249](#), [9-59](#), [12-11](#)

---

## Z

zip tones

- automatic answer mode, [9-33](#)
- CALLMASTER voice terminals, [9-18](#)
- data restricted agent extension, [9-18](#)
- Expert Agent Selection (EAS), [9-77](#)
- Service Observing, [4-552](#)
- VDN of Origin Announcement, [9-151](#)

Zydacron, [11-34](#)

